



US00D676697S

(12) **United States Design Patent**
Chopdat et al.

(10) **Patent No.:** **US D676,697 S**
(45) **Date of Patent:** **** Feb. 26, 2013**

(54) **DISPENSING DEVICE AND REFILL
CONTAINER**

(75) Inventors: **Mohammed Chopdat**, Hull (GB);
Richard Brian Clough, Warwick (GB);
Alex Peacop, Warwick (GB); **Stephanie
Ann Marije Verschoor**, Brentford (GB)

(73) Assignee: **Reckitt Benckiser Healthcare
International Limited**, Slough,
Berkshire (GB)

(**) Term: **14 Years**

(21) Appl. No.: **29/406,526**

(22) Filed: **Nov. 15, 2011**

(30) **Foreign Application Priority Data**

May 23, 2011 (EM) 001867300-0001

(51) **LOC (9) Cl.** **23-02**

(52) **U.S. Cl.** **D6/542**

(58) **Field of Classification Search** D6/542-545;
D9/682, 688, 690, 291, 448, 449; 221/282;
222/14, 173, 146.3, 628, 251, 181.1, 181.3

See application file for complete search history.

(56) **References Cited**

U.S. PATENT DOCUMENTS

D565,878	S	*	4/2008	Krus	D6/542
D622,991	S	*	9/2010	MacDonald et al.	D6/542
D659,453	S	*	5/2012	Fernandes et al.	D6/542
D661,932	S	*	6/2012	DelGigante et al.	D6/542
D662,741	S	*	7/2012	DelGigante et al.	D6/542
D663,143	S	*	7/2012	DelGigante et al.	D6/542
D663,983	S	*	7/2012	Yang et al.	D6/542

* cited by examiner

Primary Examiner — Brian N Vinson

(74) *Attorney, Agent, or Firm* — Ryan A. Schneider;
Troutman Sanders LLP

(57) **CLAIM**

The ornamental design for a dispensing device and refill container, as shown and described.

DESCRIPTION

FIG. 1 is a top, front, and right side perspective view of a dispensing device and refill container showing our new design;

FIG. 2 is a front elevational view thereof;

FIG. 3 is a rear elevational view thereof;

FIG. 4 is a left side elevational view thereof;

FIG. 5 a right side elevational view thereof;

FIG. 6 is a top plan view thereof; and,

FIG. 7 is a bottom plan view thereof.

1 Claim, 6 Drawing Sheets

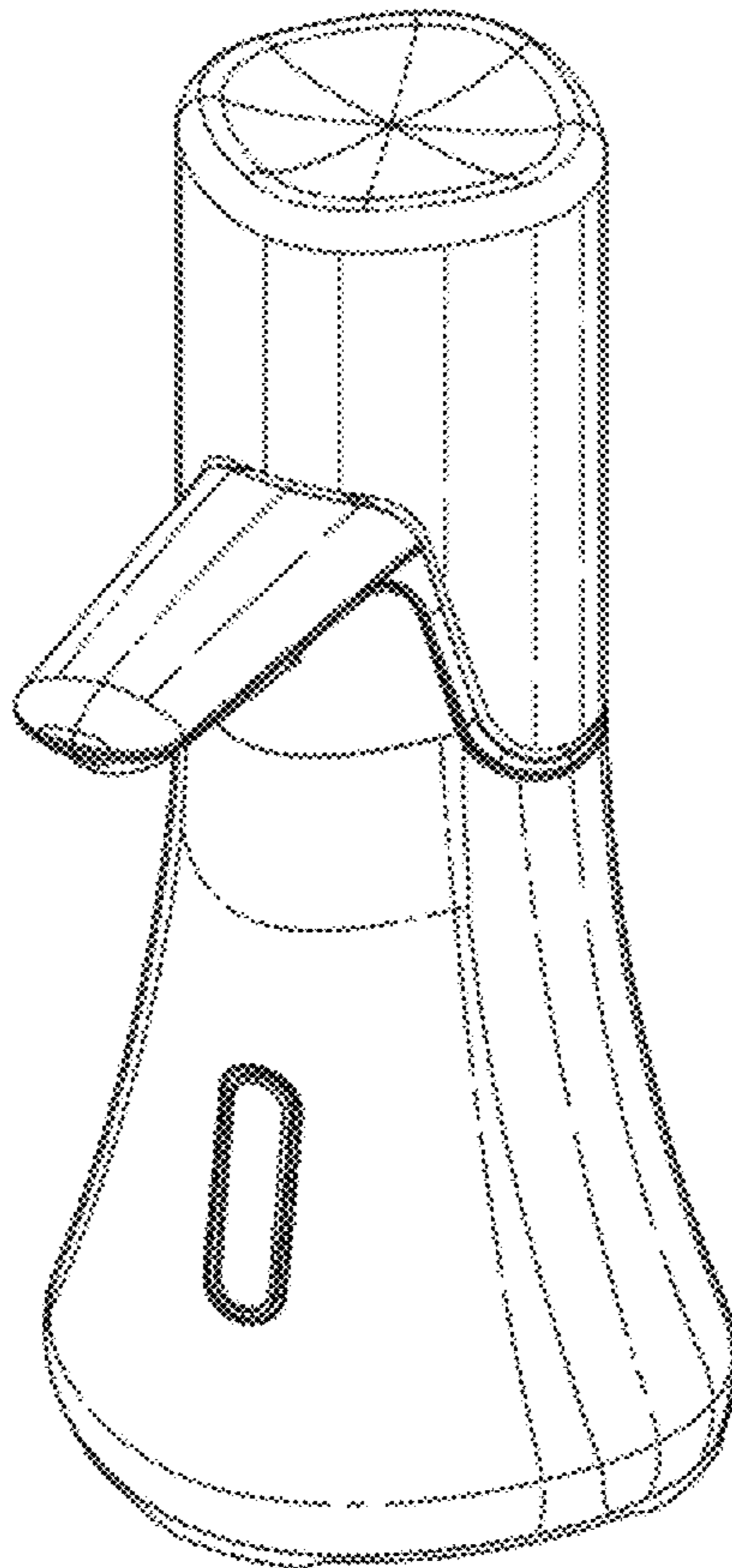

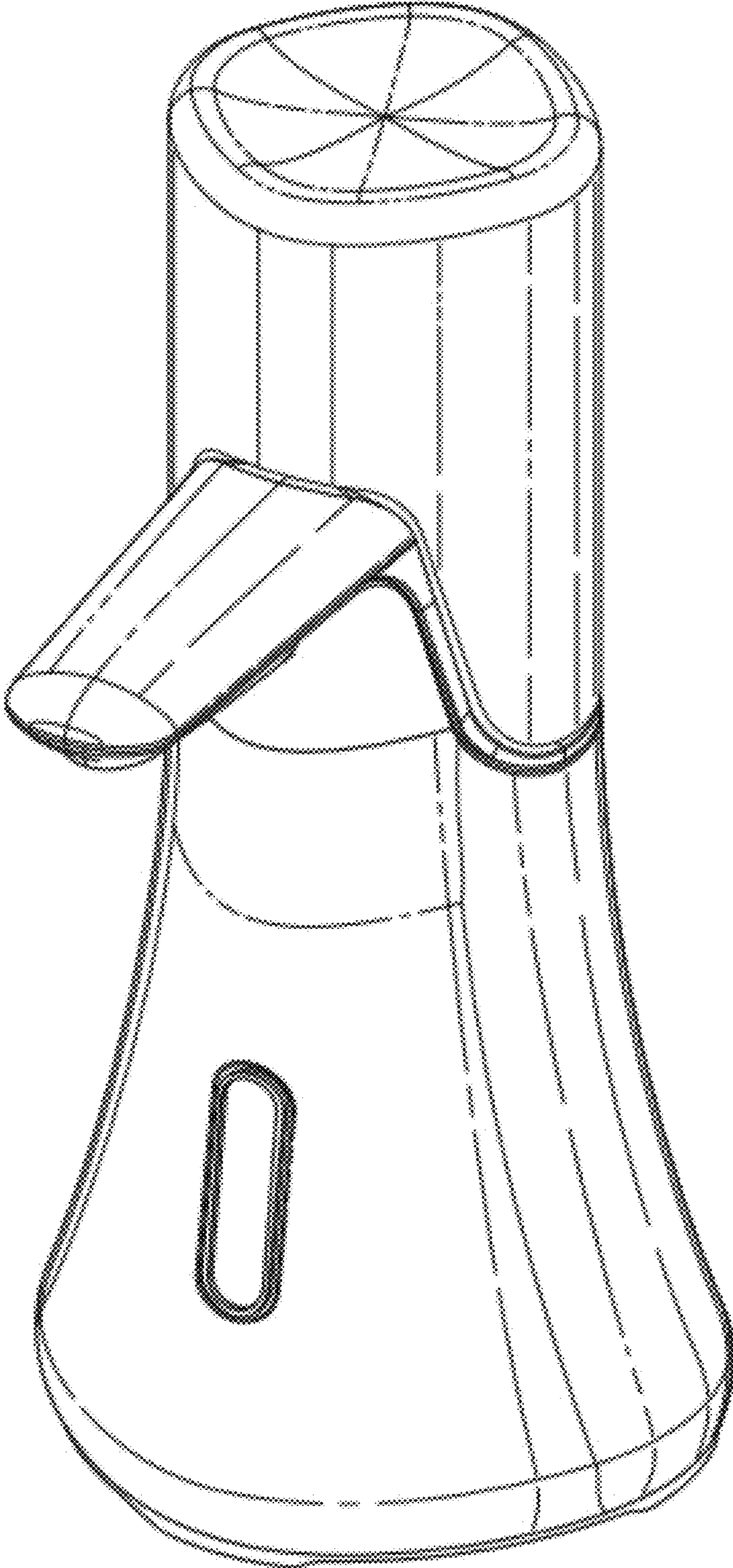

Fig. 1

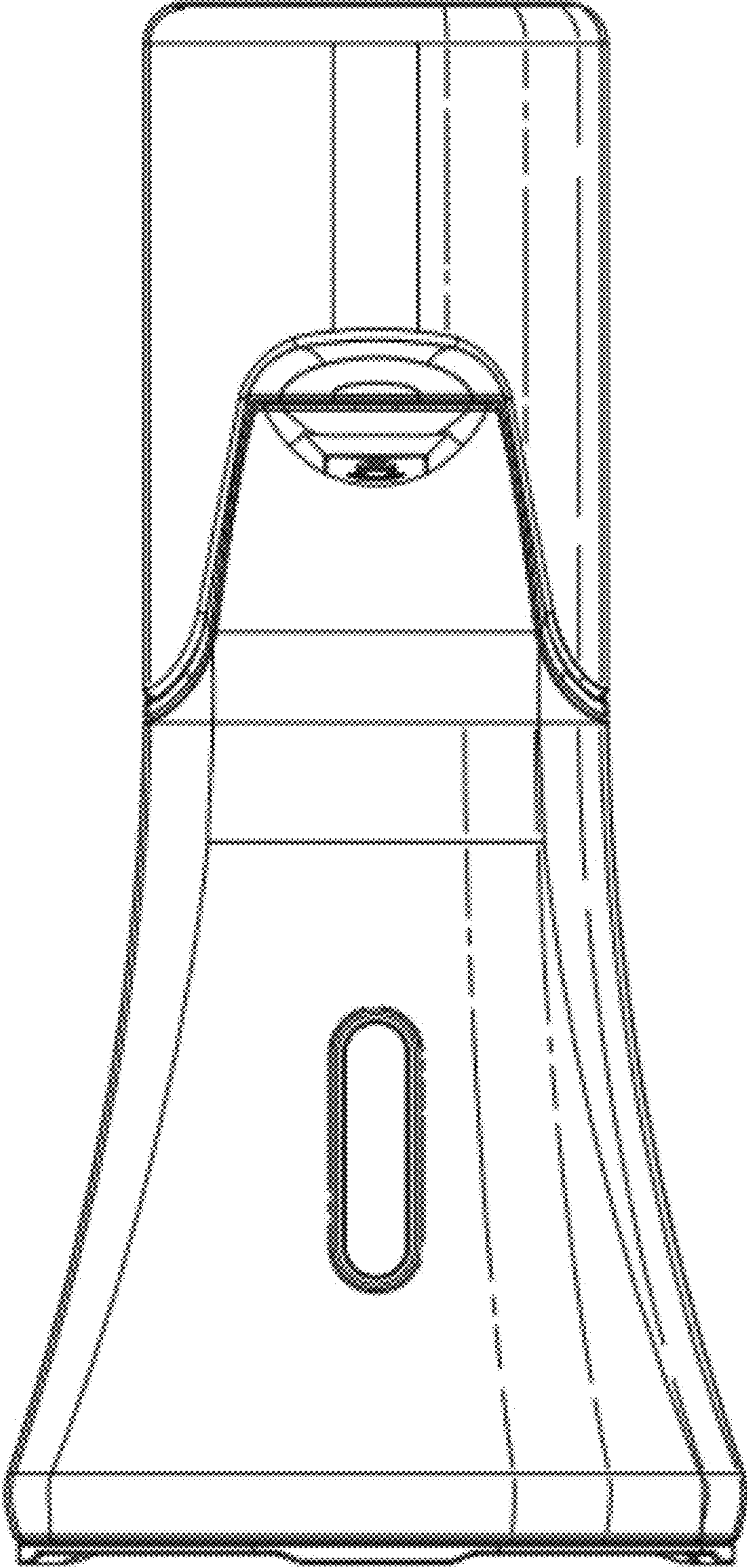

Fig. 2

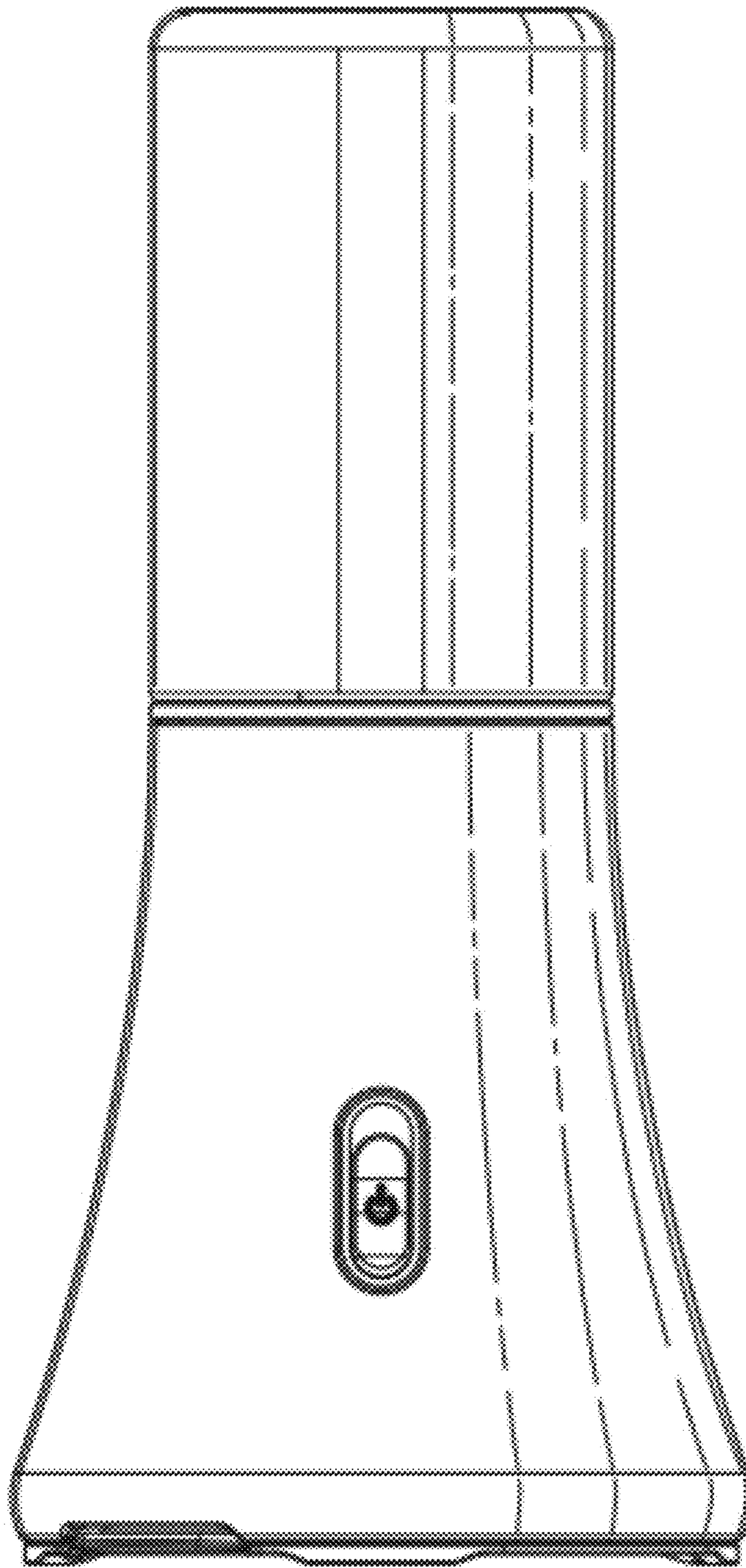

Fig. 3

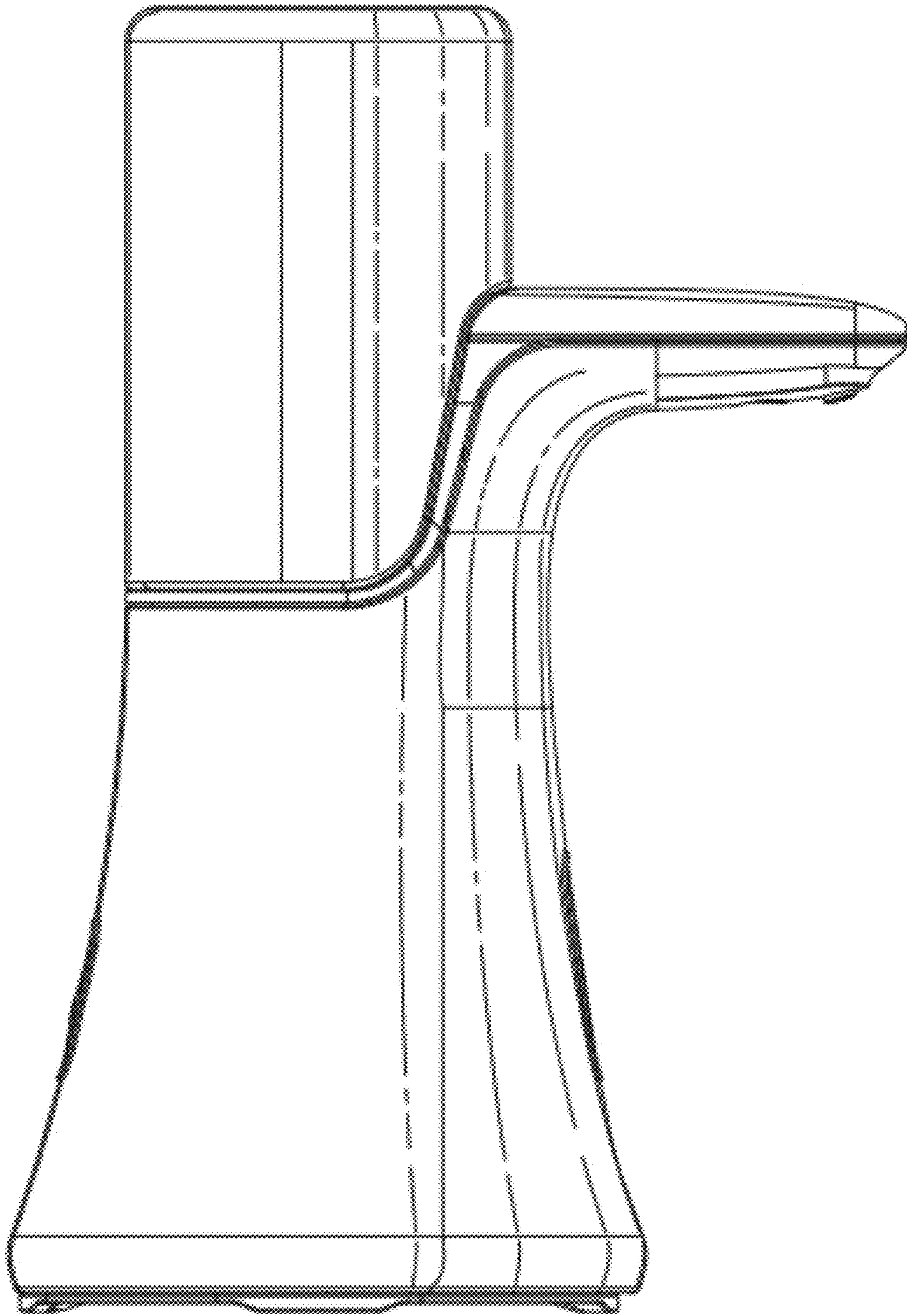

Fig. 4

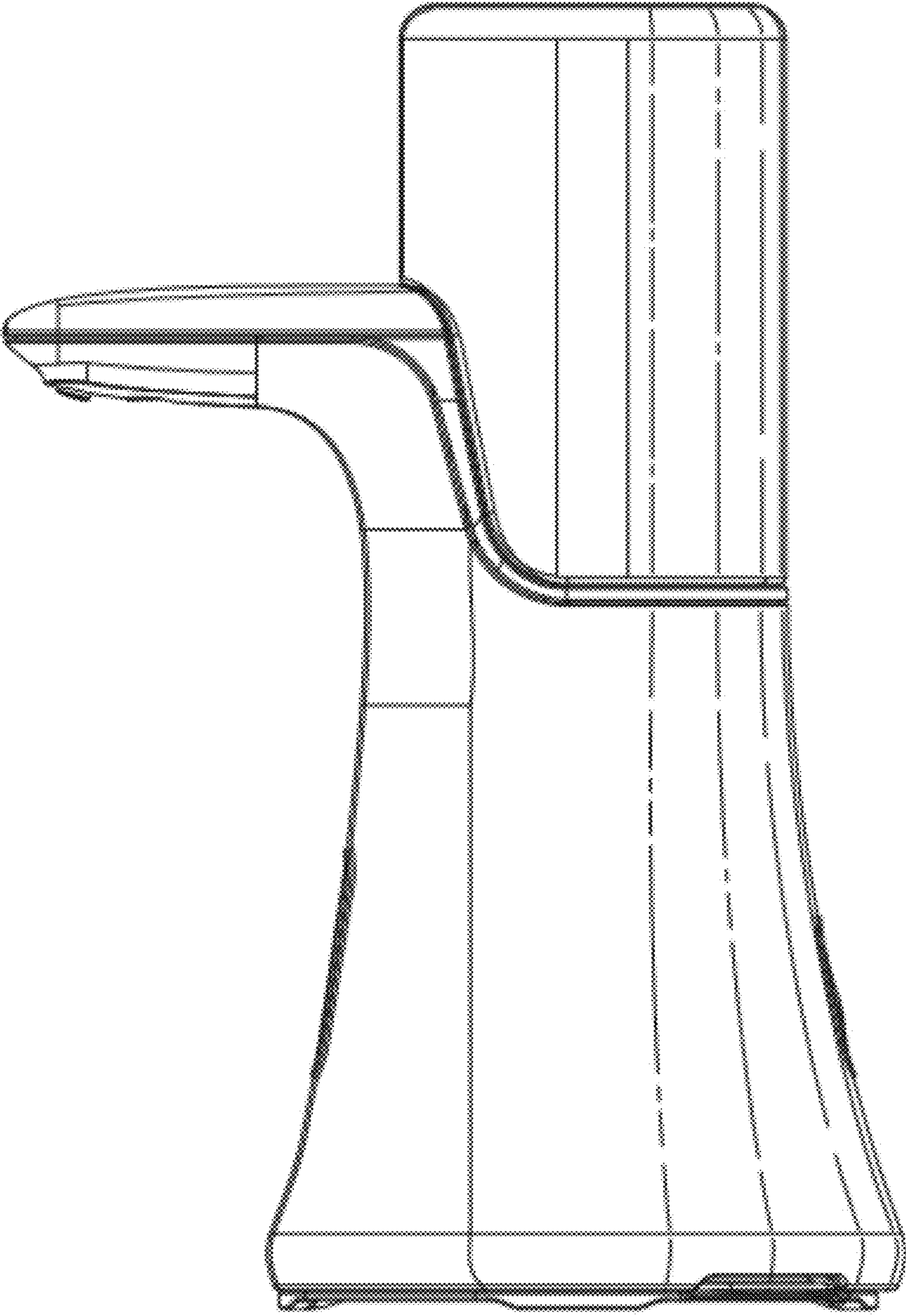

Fig. 5

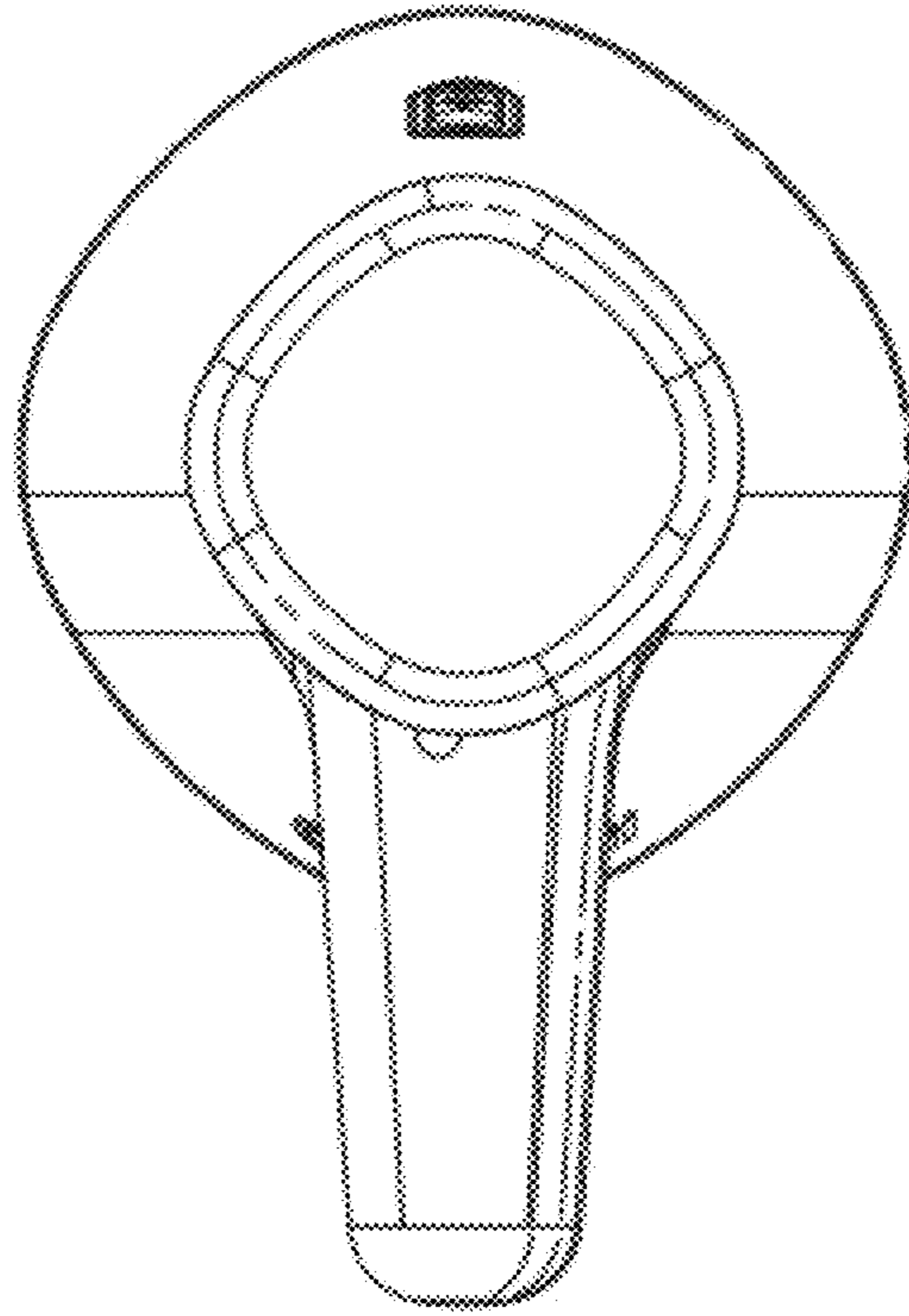

Fig. 6

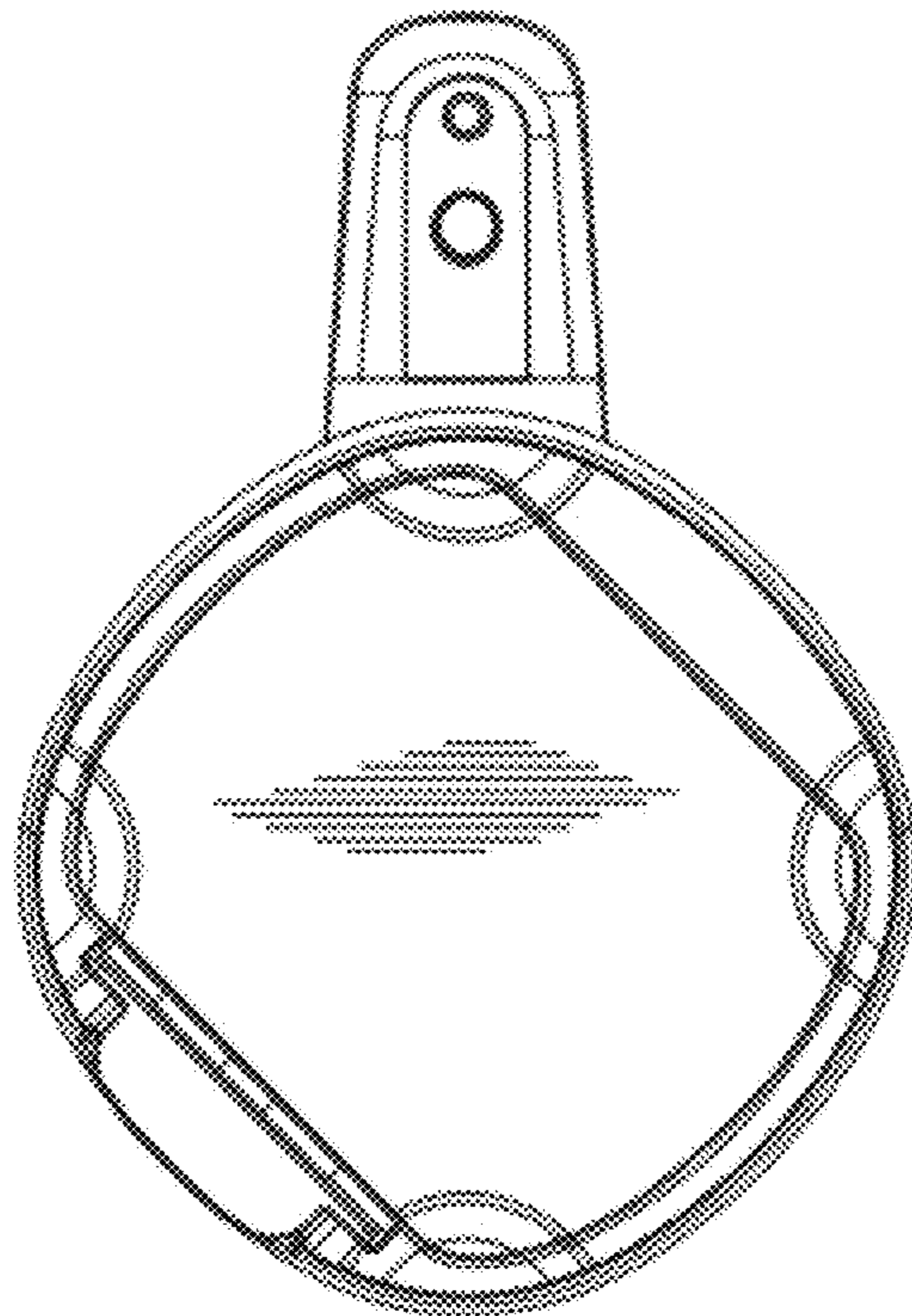

Fig. 7