



US00D676657S

(12) **United States Design Patent**
Knecht

(10) **Patent No.:** **US D676,657 S**

(45) **Date of Patent:** **** Feb. 26, 2013**

(54) **ATTACHABLE HANGING BAG**

(76) Inventor: **Wendy S. Knecht**, Studio City, CA (US)

(**) Term: **14 Years**

(21) Appl. No.: **29/412,695**

(22) Filed: **Feb. 7, 2012**

(51) **LOC (9) Cl.** **03-01**

(52) **U.S. Cl.** **D3/303**

(58) **Field of Classification Search** D3/232–233,
D3/240–246, 303; 206/576, 701–703, 320,
206/37–38, 235

See application file for complete search history.

(56) **References Cited**

U.S. PATENT DOCUMENTS

D416,677 S *	11/1999	Christman	D3/246
D422,411 S *	4/2000	Martin	D3/303
D587,010 S *	2/2009	Deck	D3/246
D619,901 S *	7/2010	Wolf	D9/631

* cited by examiner

Primary Examiner — Holly Baynham

(74) *Attorney, Agent, or Firm* — Fish and Richardson, PC;
Tim French; Gregory Madera

(57) **CLAIM**

The ornamental design for an attachable hanging bag, as shown and described.

DESCRIPTION

FIG. 1 is a perspective view of an attachable hanging bag of my design;

FIG. 2 is the front view of the attachable hanging bag of FIG. 1;

FIG. 3 is a rear view of the attachable hanging bag of FIG. 1; FIG. 4 is a left side view of the attachable hanging bag of FIG. 1;

FIG. 5 is a right side view of the attachable hanging bag of FIG. 1;

FIG. 6 is a top view of the attachable hanging bag of FIG. 1; and

FIG. 7 is a bottom view of the attachable hanging bag of FIG. 1; and,

FIG. 8 is another perspective view of the attachable hanging bag of my design, shown hanging, e.g., from a railing, arm rest, post, handle, towel rack, etc., for easy accessibility to contents of the attachable hanging bag.

The broken lines showing portions of the hanging bag, railing, bed, arm rest, post, handle, towel rack and human figure are for the purposes of illustrating environment and form no part of the claimed design.

1 Claim, 5 Drawing Sheets

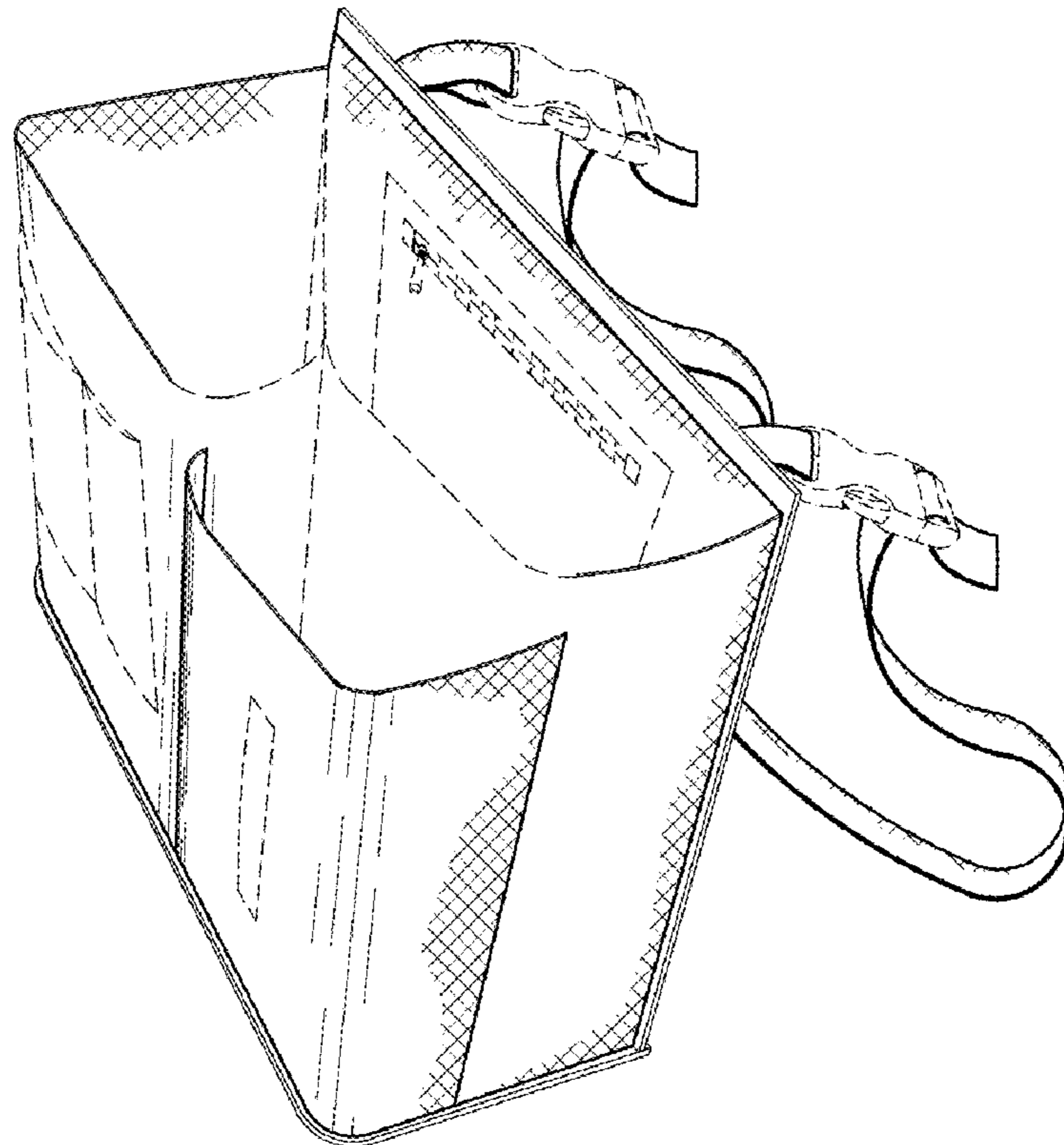

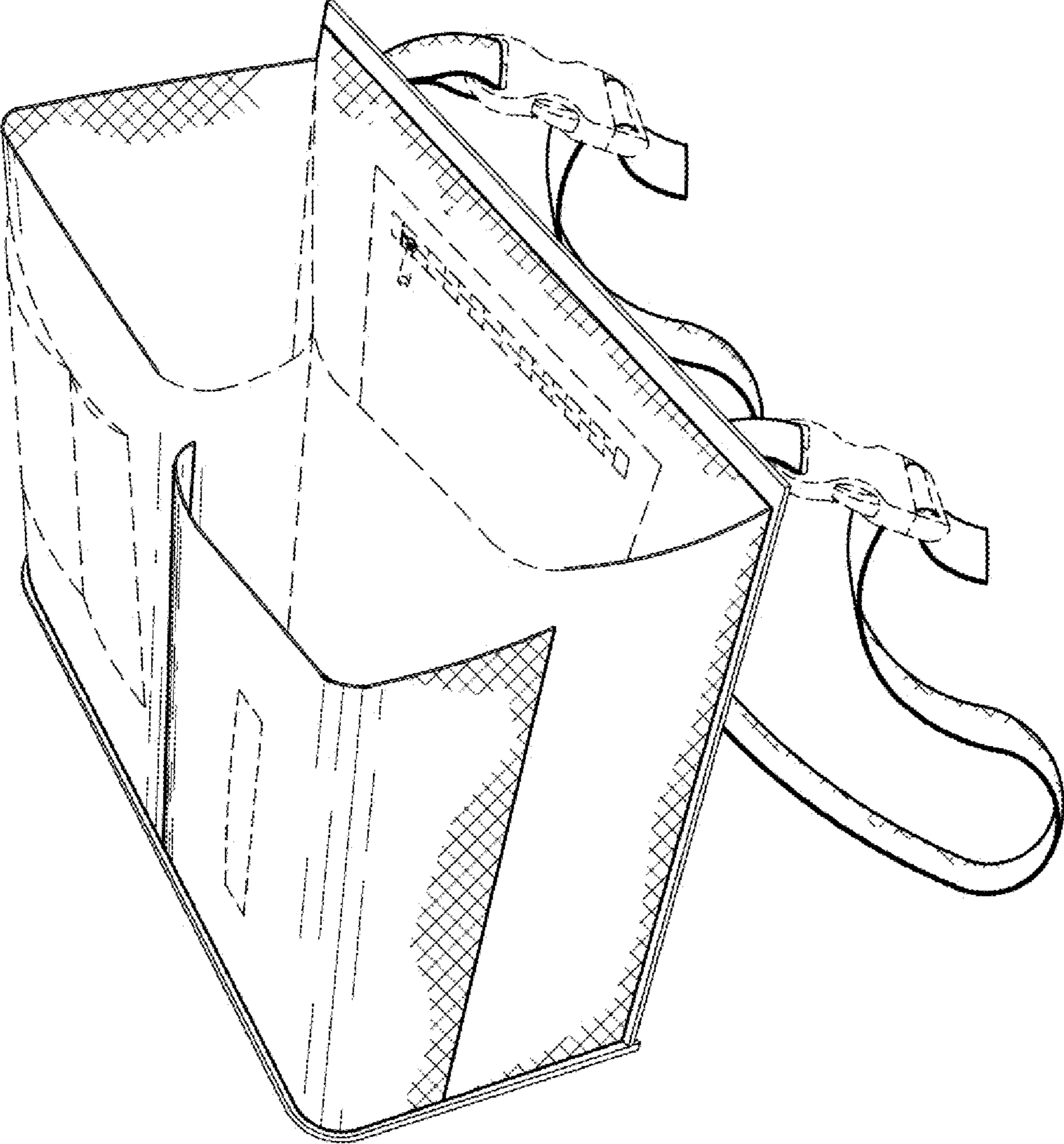

FIG. 1

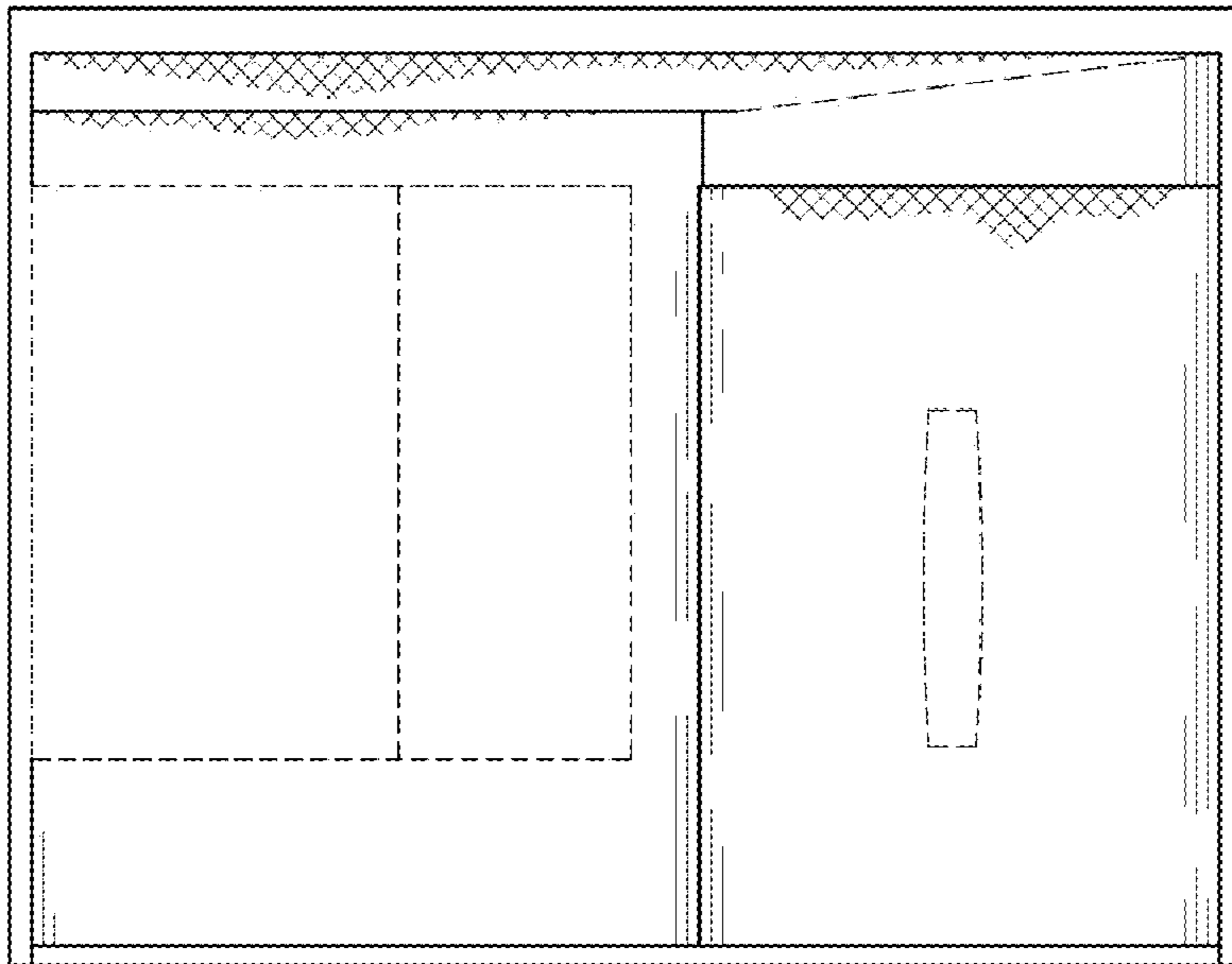

FIG. 2

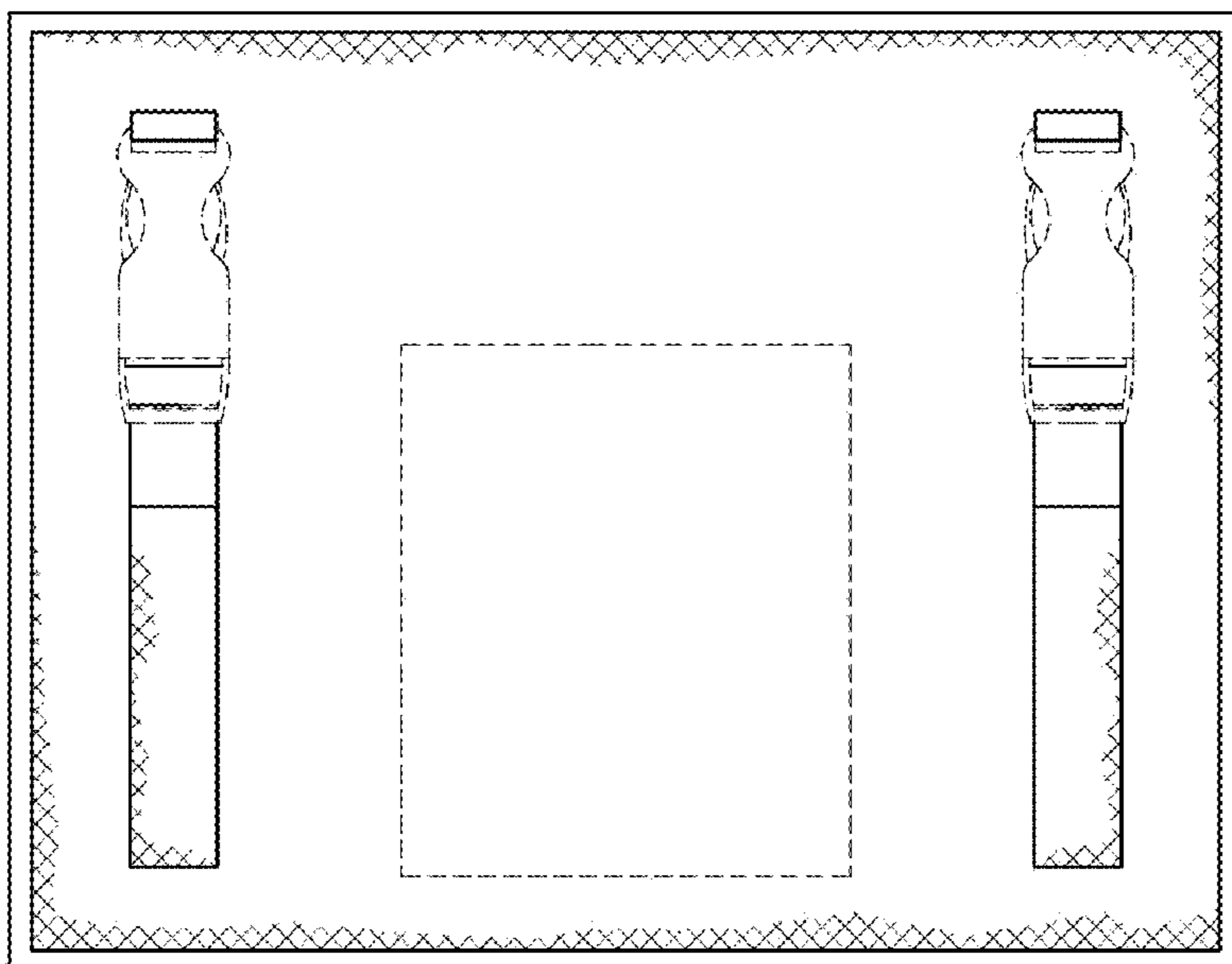

FIG. 3

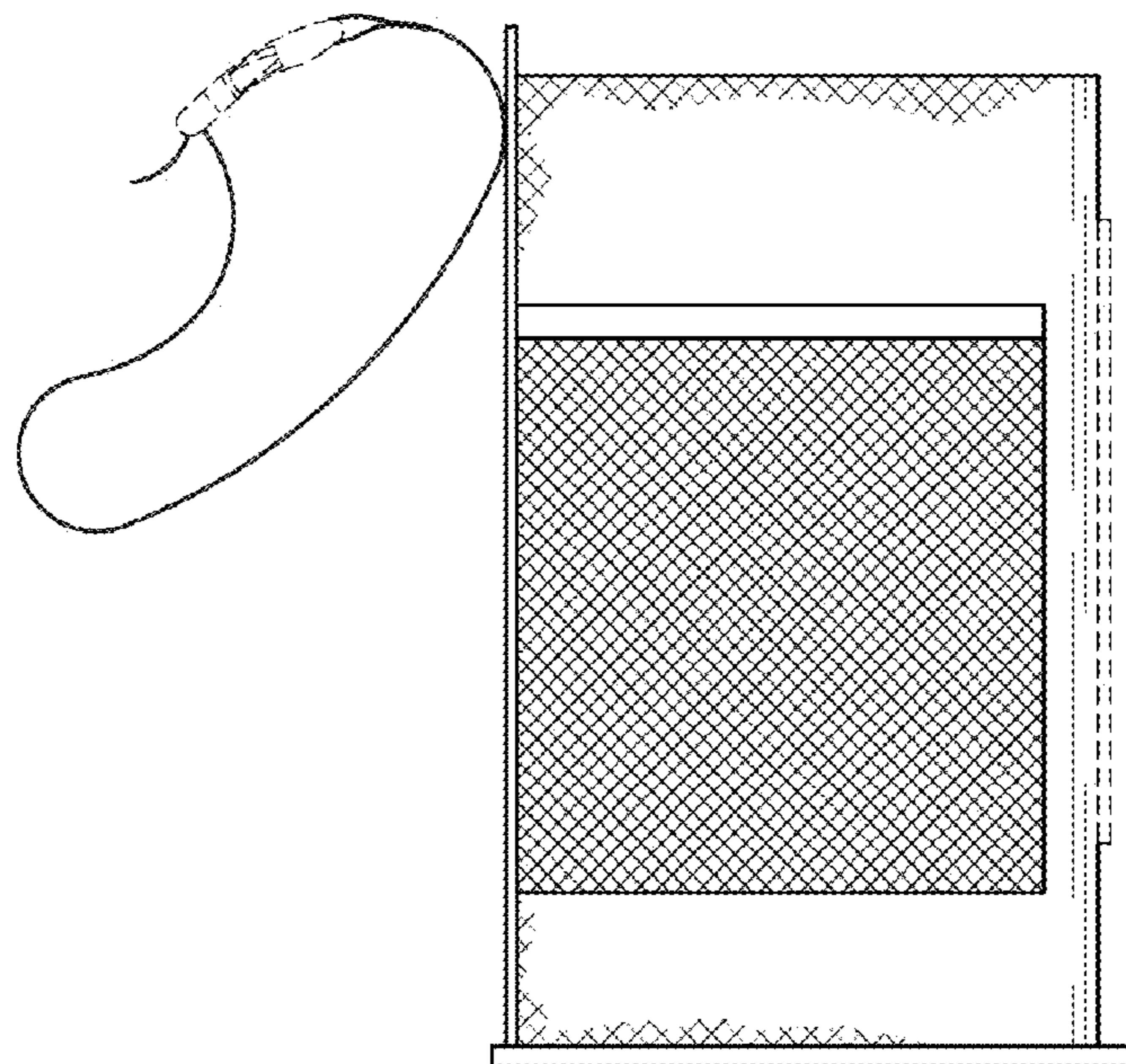

FIG. 4

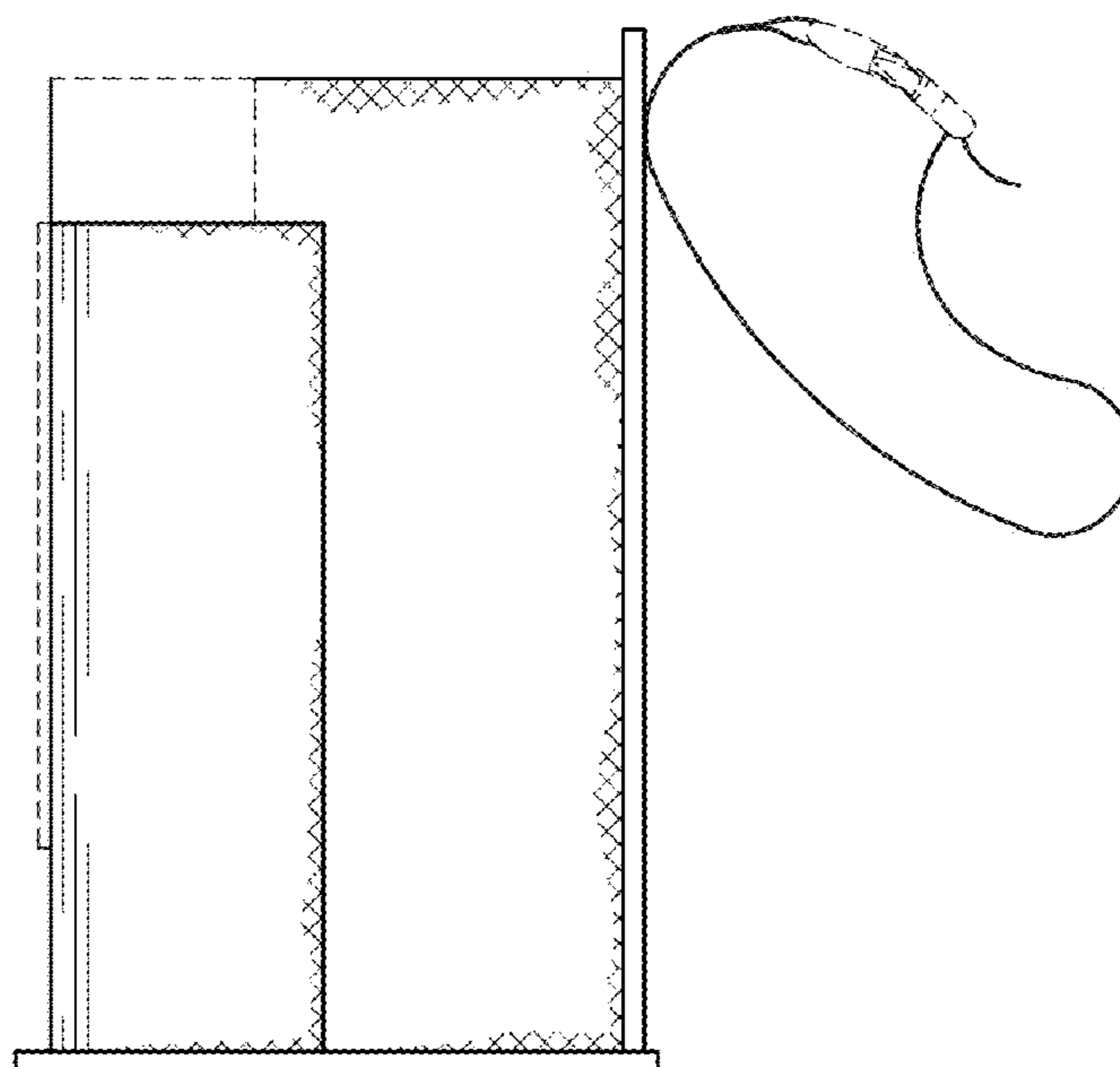

FIG. 5

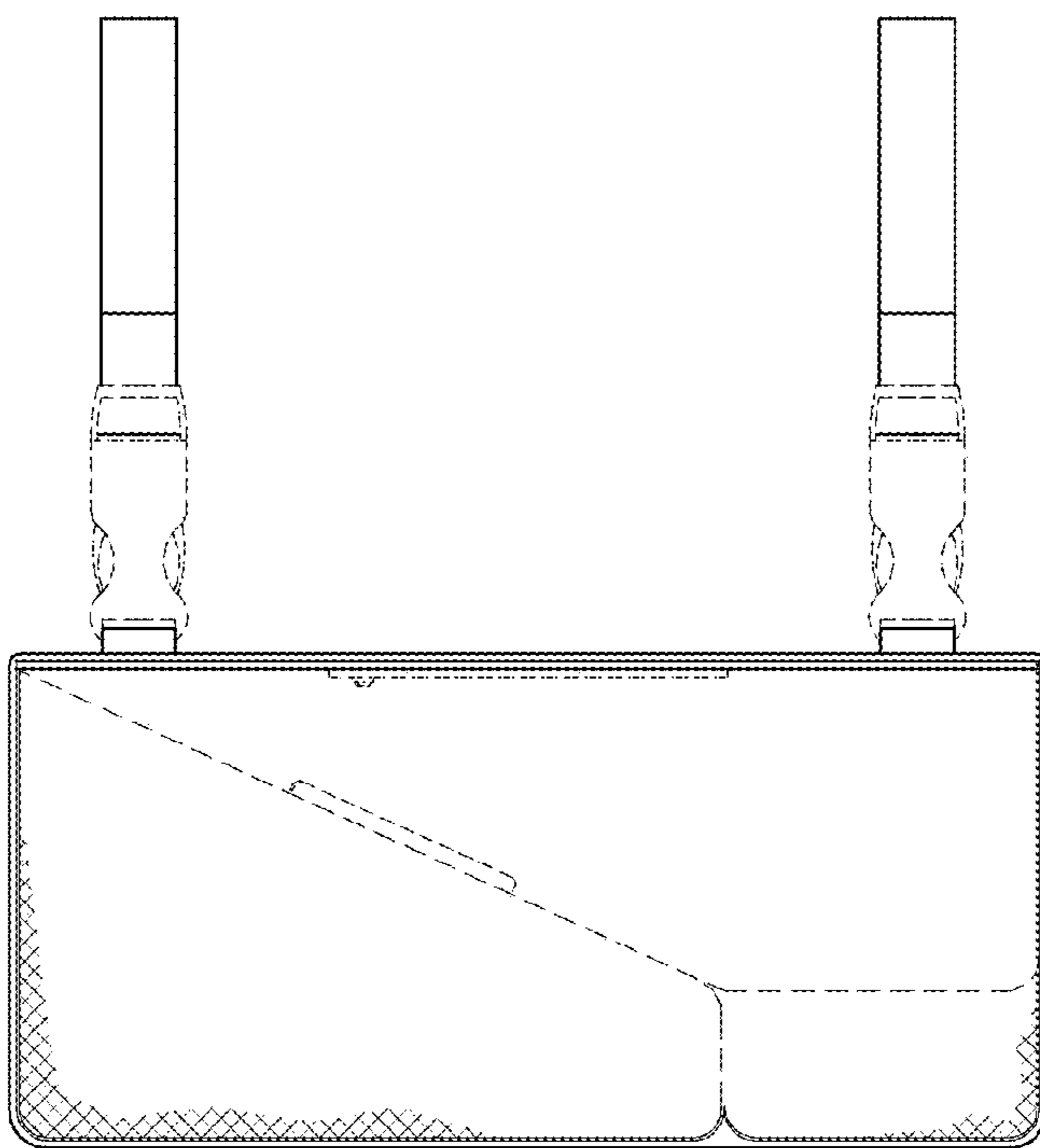

FIG. 6

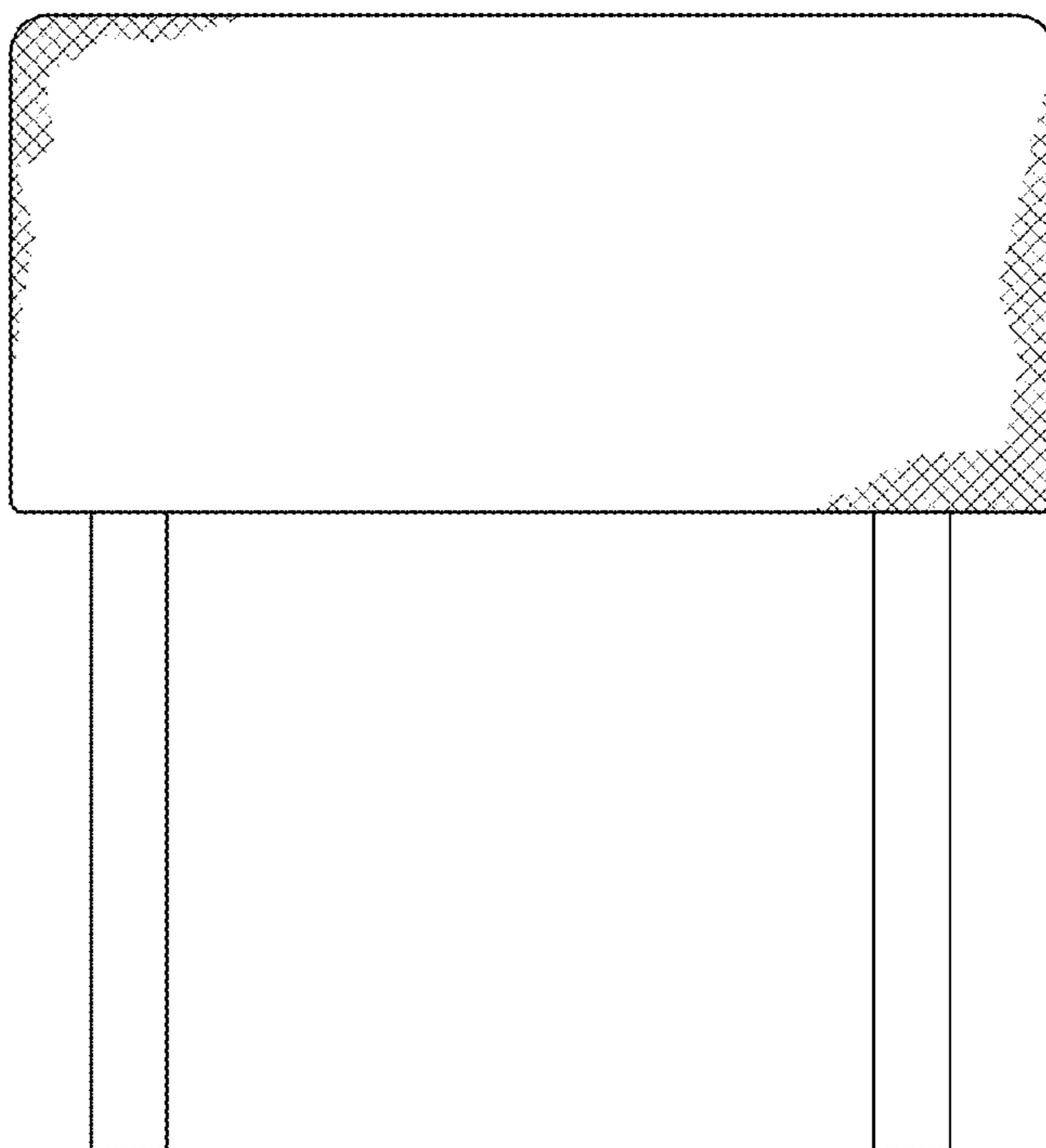

FIG. 7

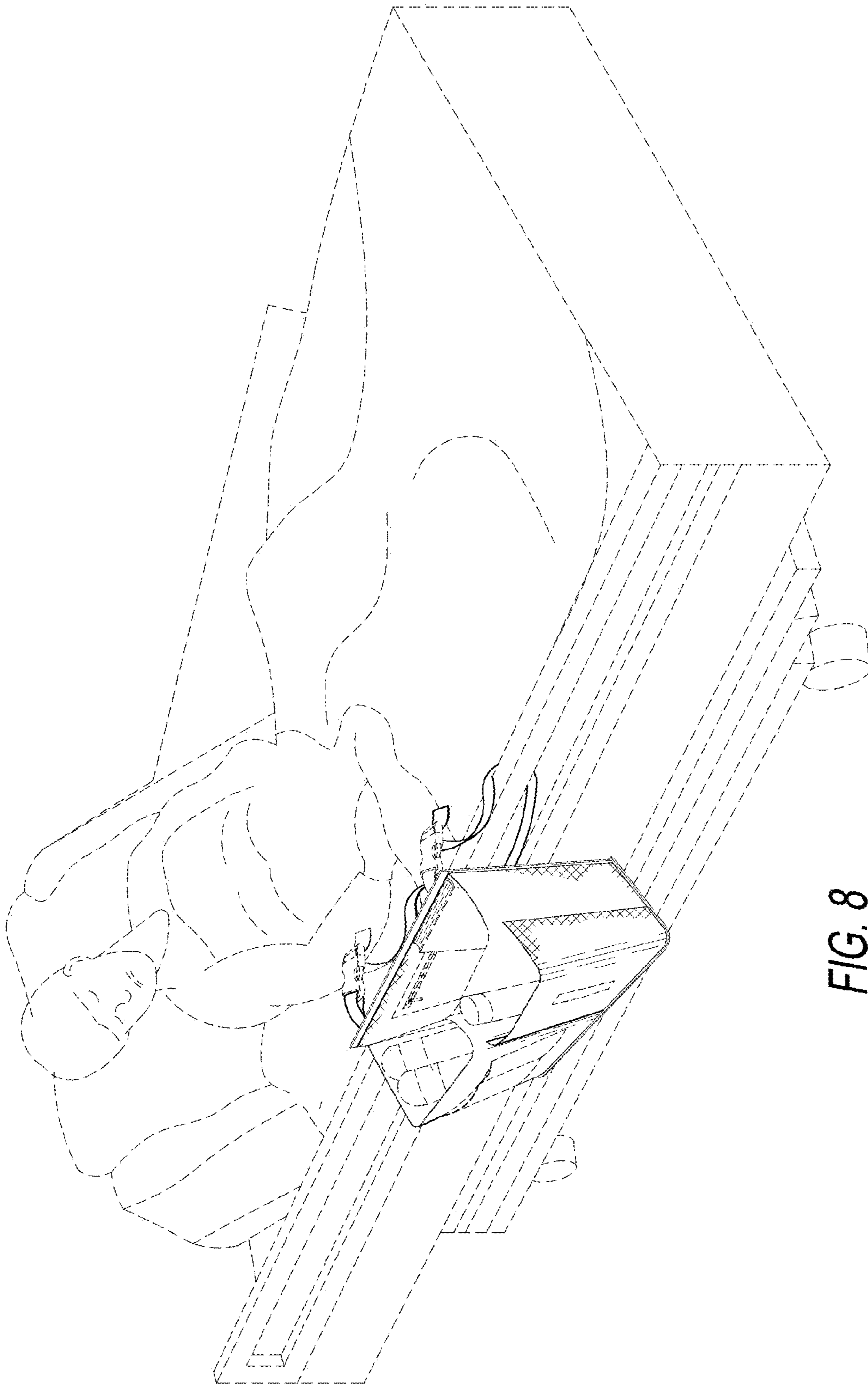

FIG. 8