



US00D676633S

(12) **United States Design Patent**
Doherty et al.

(10) **Patent No.:** **US D676,633 S**

(45) **Date of Patent:** **** Feb. 26, 2013**

(54) **CASUAL FOOTWEAR**

(75) Inventors: **Maria E. Doherty**, Bristol, RI (US);
Donna M. Wilson, Bristol, RI (US)

(73) Assignee: **Flippity Funwear**, Bristol, RI (US)

(**) Term: **14 Years**

(21) Appl. No.: **29/430,346**

(22) Filed: **Aug. 24, 2012**

(51) **LOC (9) Cl.** **02-04**

(52) **U.S. Cl.** **D2/917**

(58) **Field of Classification Search** D2/896-900,
D2/903, 916-925, 943, 946, 969, 971, 976;
36/7.3, 7.5, 11.5, 45, 3 A, 3 R, 136; D28/41
See application file for complete search history.

(56) **References Cited**

U.S. PATENT DOCUMENTS

| | | | | | | |
|-----------|----|---|---------|--------------|-------|---------|
| 1,480,009 | A | * | 1/1924 | Preston | | 132/275 |
| D85,346 | S | * | 10/1931 | Riker | | D2/976 |
| D131,844 | S | * | 3/1942 | Viver | | D2/976 |
| D167,533 | S | * | 8/1952 | Pastine | | D2/917 |
| D187,781 | S | * | 5/1960 | Hayakawa | | D2/917 |
| D421,665 | S | * | 3/2000 | Farmer-Abney | | D28/43 |
| 6,769,204 | B1 | | 8/2004 | Phillips | | |

| | | | | | | |
|----------|---|---|---------|---------|-------|--------|
| D606,731 | S | * | 12/2009 | Bridges | | D2/917 |
| D613,044 | S | * | 4/2010 | Fu | | D2/917 |
| D619,341 | S | * | 7/2010 | Fu | | D2/917 |
| D631,235 | S | * | 1/2011 | Cona | | D2/917 |

* cited by examiner

Primary Examiner — Robert M Spear

Assistant Examiner — Rashida C McCoy

(74) *Attorney, Agent, or Firm* — Salter & Michaelson

(57) **CLAIM**

The ornamental design for casual footwear, as shown and described.

DESCRIPTION

FIG. 1 is a perspective view of casual footwear;
FIG. 2 is a top plan view thereof;
FIG. 3 is a bottom plan view thereof;
FIG. 4 is a right side elevational view thereof;
FIG. 5 is a left side elevational view thereof;
FIG. 6 is a front elevational view thereof;
FIG. 7 is a rear elevational view thereof; and,
FIG. 8 is a perspective view thereof showing the casual footwear with the bow removed.
The portions shown in broken lines are included for illustrative purposes only and form no part of the claimed design.

1 Claim, 8 Drawing Sheets

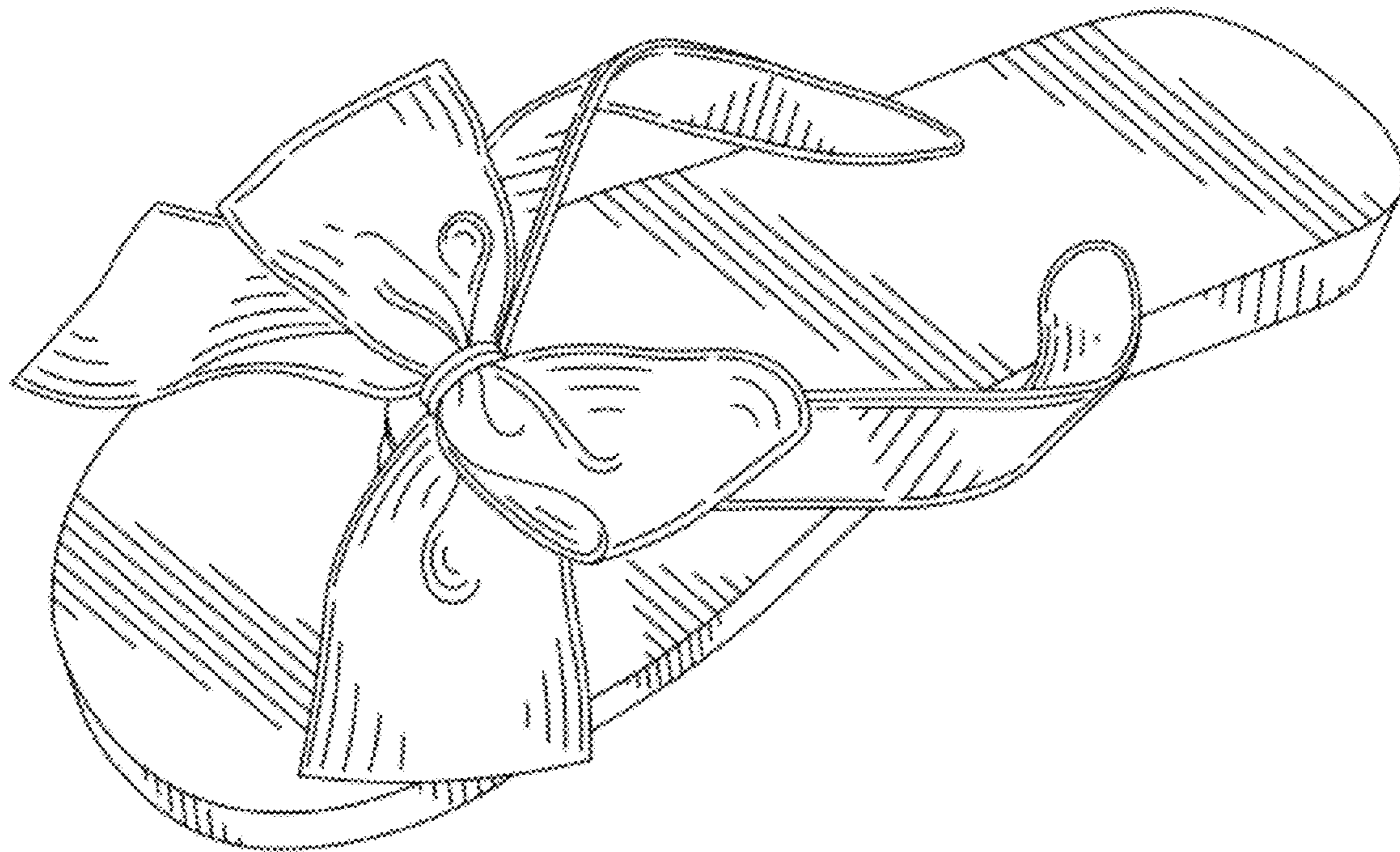

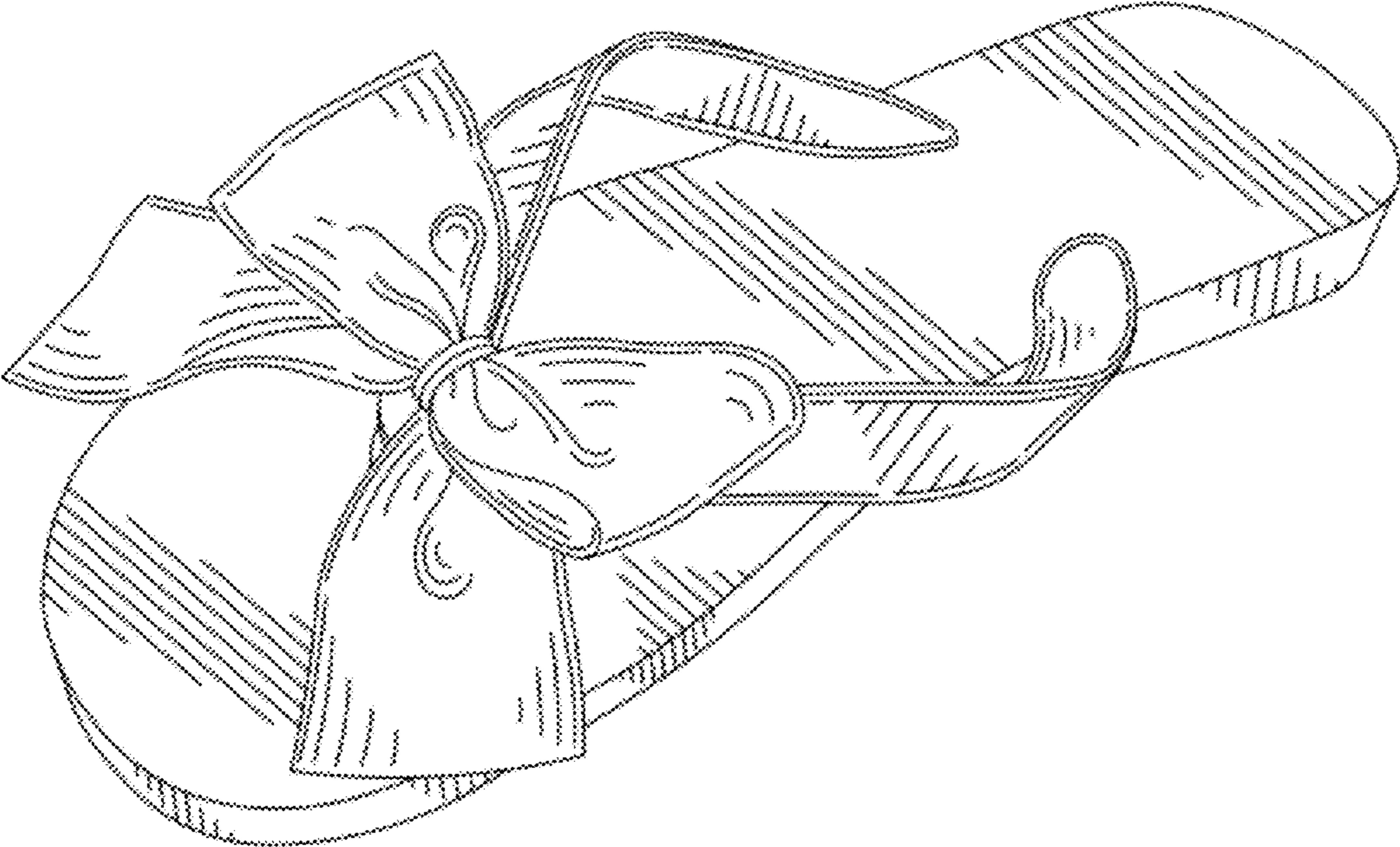

FIG. 1

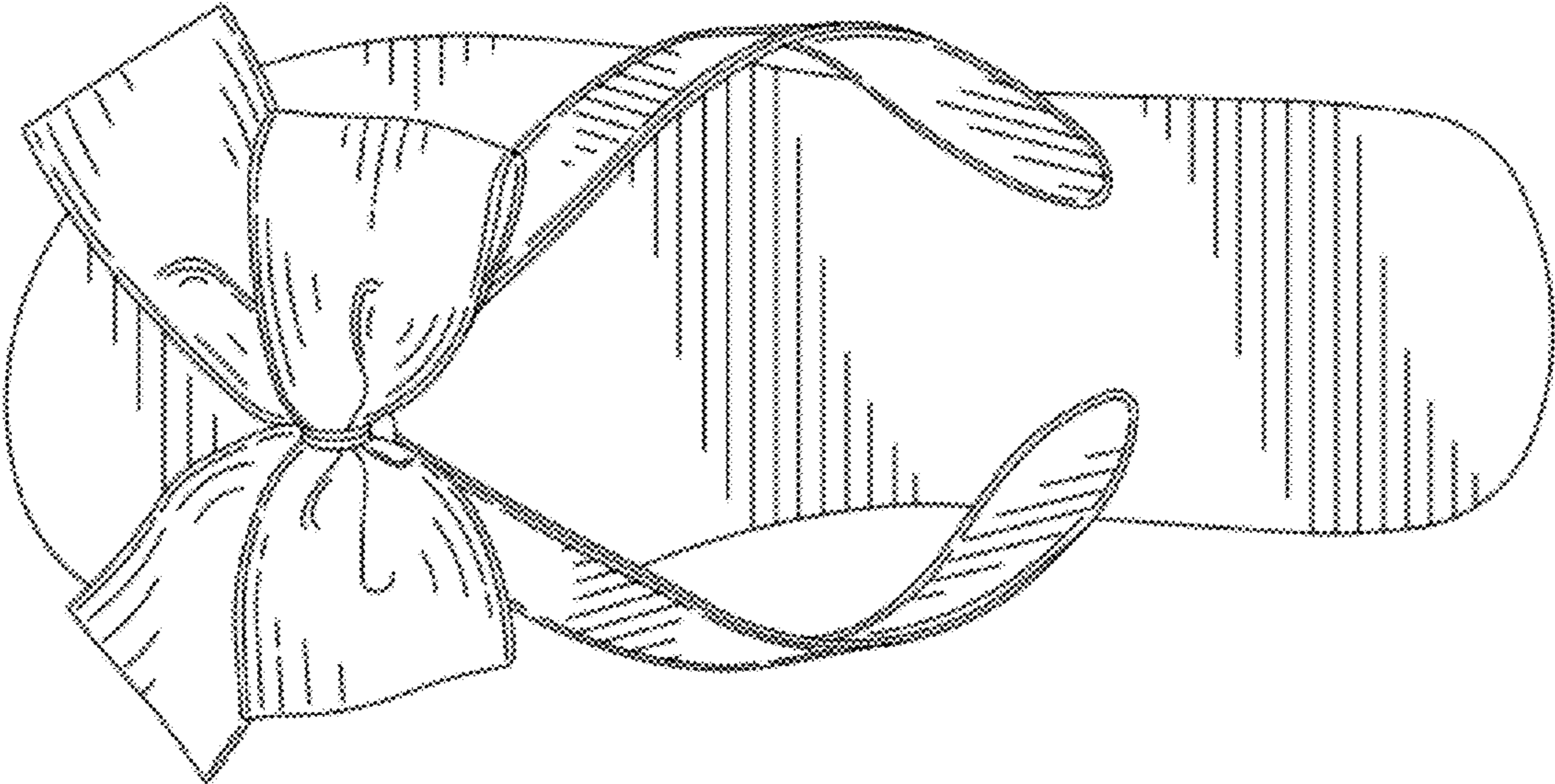

FIG. 2

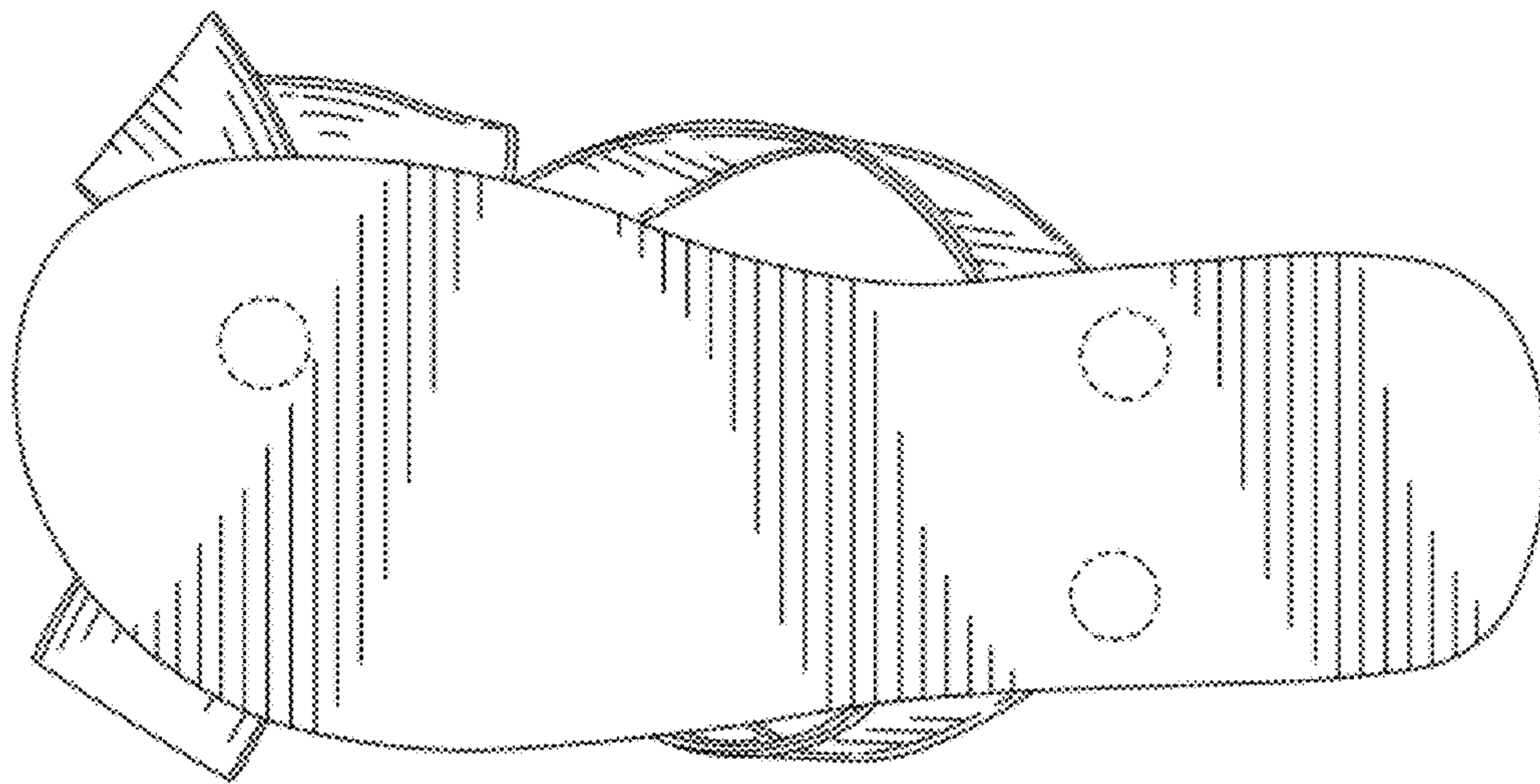

FIG. 3

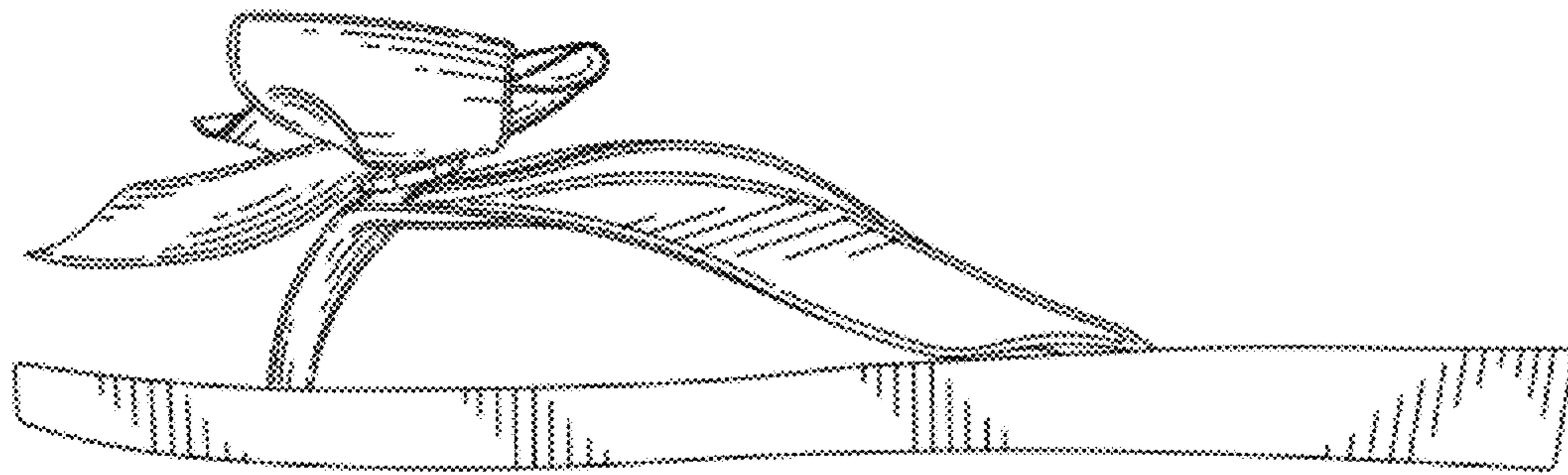

FIG. 4

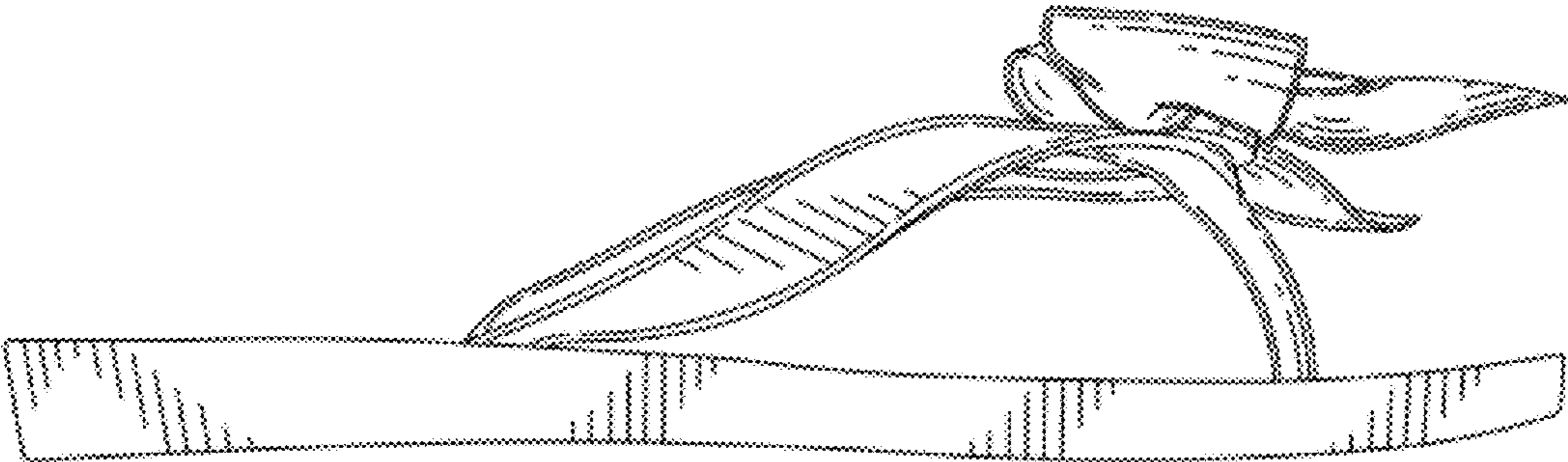

FIG. 5

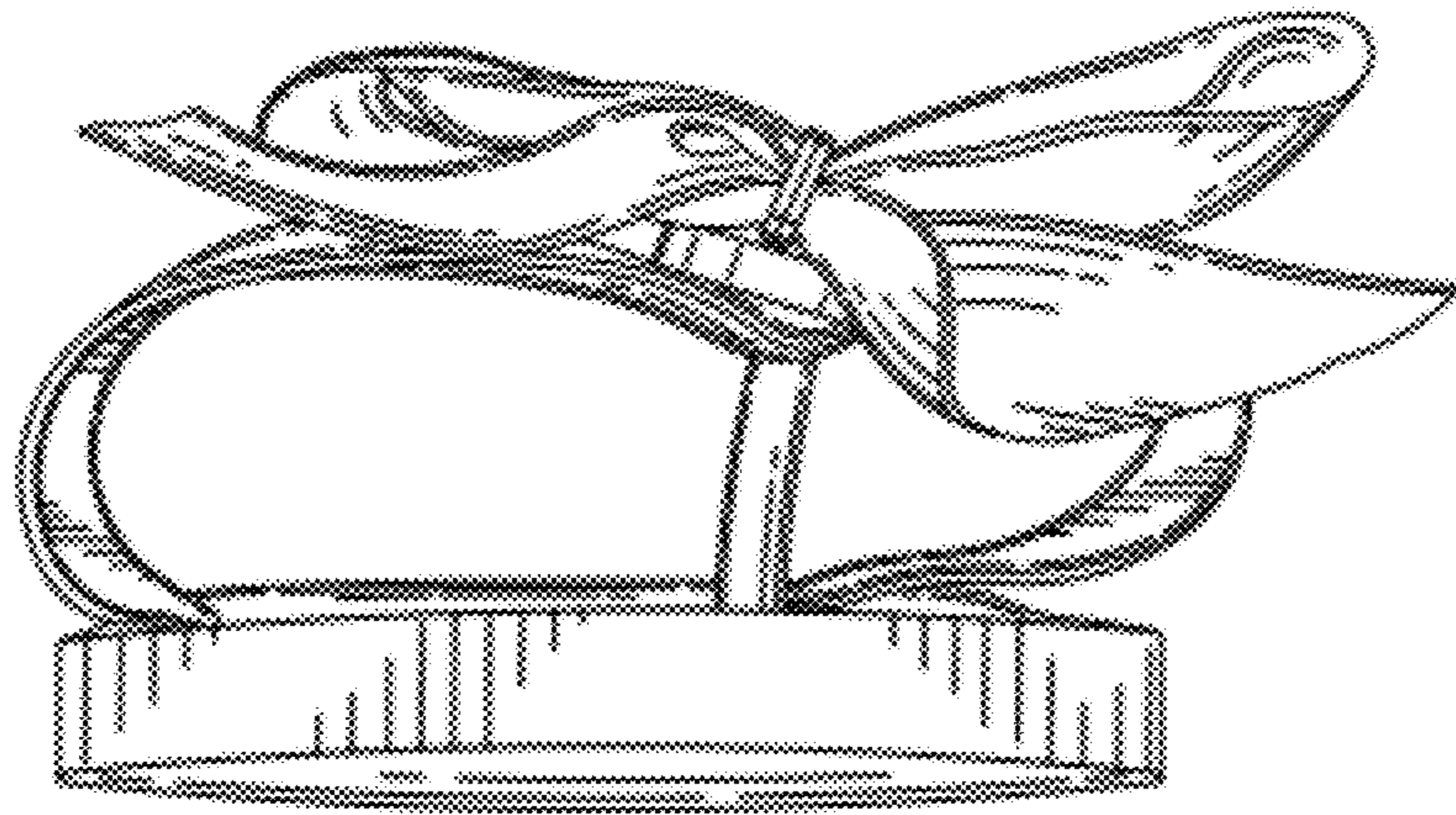

FIG. 6

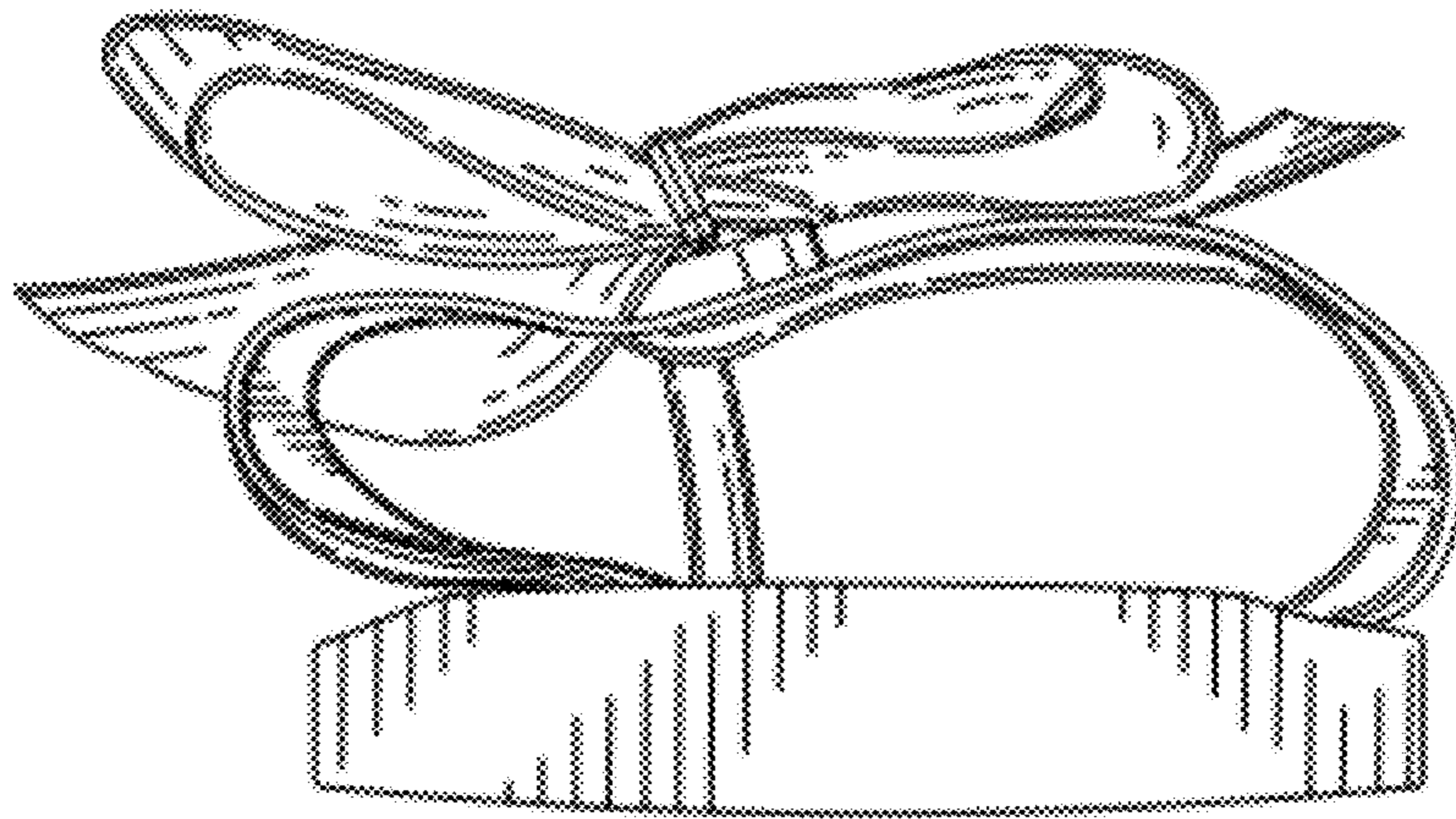

FIG. 7

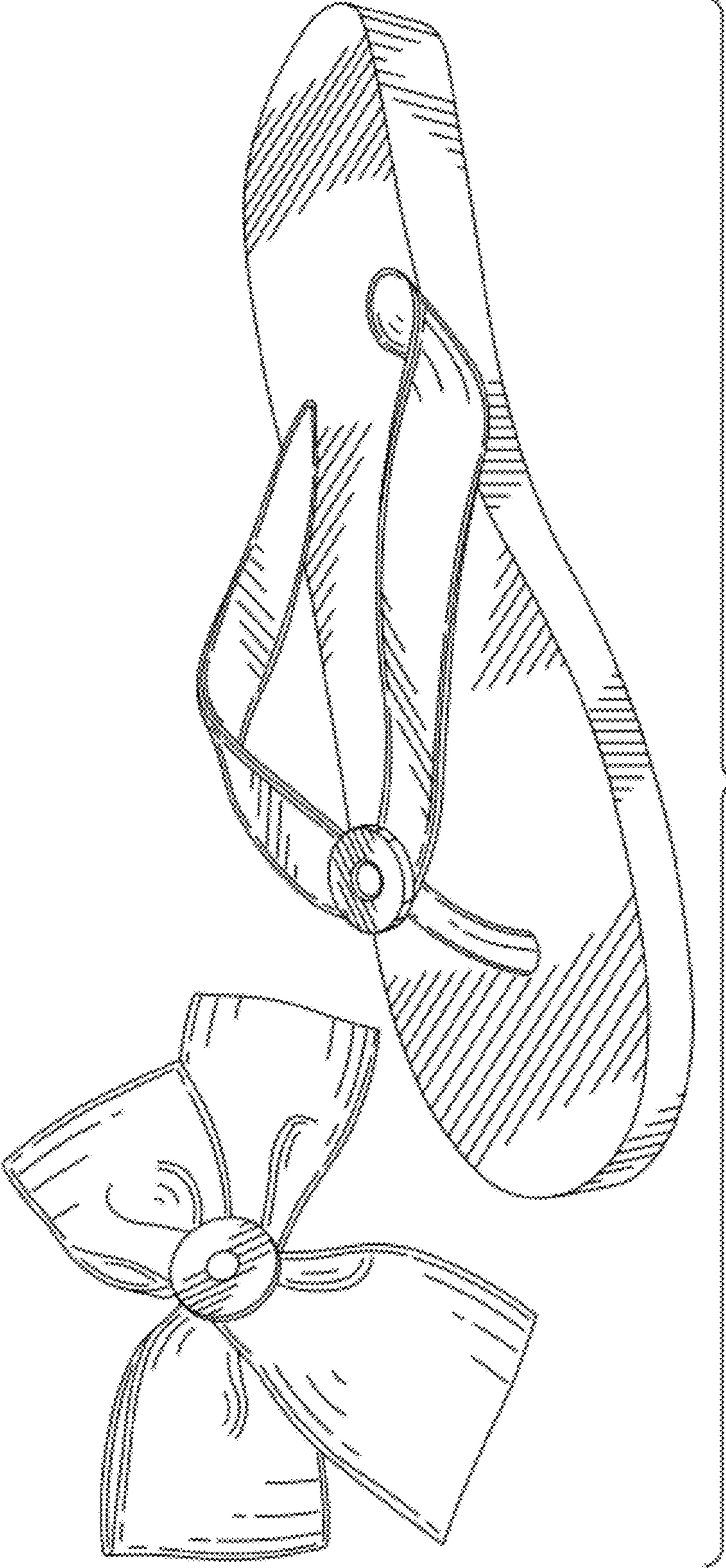

FIG. 8