



US00D676610S

(12) **United States Design Patent**
Kim

(10) **Patent No.:** **US D676,610 S**
(45) **Date of Patent:** **** Feb. 19, 2013**

(54) **NAIL CLIPPINGS COLLECTOR FOR NAIL CLIPPER**

2006/0026839 A1 * 2/2006 Merheje 30/28
2006/0143923 A1 * 7/2006 Blair et al. 30/28
2009/0000122 A1 * 1/2009 Han et al. 30/28

(75) Inventor: **Gab Soo Kim**, Bucheon-si (KR)

* cited by examiner

(73) Assignee: **Royal Metal Industrial Co., Ltd.**,
Bucheon-si, Gyeonggi-do

Primary Examiner — Jennifer Rivard
(74) *Attorney, Agent, or Firm* — Renaissance IP Law Group
LLP (Portland IP)

(**) Term: **14 Years**

(57) **CLAIM**

(21) Appl. No.: **29/405,155**

The ornamental design for a nail clippings collector for nail clipper, as shown and described.

(22) Filed: **Oct. 28, 2011**

DESCRIPTION

(30) **Foreign Application Priority Data**

Apr. 28, 2011 (KR) 30-2011-0017409

(51) **LOC (9) Cl.** **28-03**

(52) **U.S. Cl.** **D28/62**

(58) **Field of Classification Search** D28/60,
D28/62; 132/73, 75, 75.4, 75.5, 76.5; 30/26–29
See application file for complete search history.

FIG. 1 is a perspective view of a nail clippings collector for nail clipper showing our new design;
FIG. 2 is a front elevational view thereof;
FIG. 3 is a rear elevational thereof;
FIG. 4 is a left side elevational view thereof;
FIG. 5 is a right side elevational view thereof;
FIG. 6 is a top plan view thereof;
FIG. 7 is a bottom plan view thereof; and,
FIG. 8 is an exploded perspective view of a nail clippings collector for nail clipper, the opposite perspective view is a mirror image thereof.

The broken lines shown in the drawings illustrate the environment of the article and form no part of the claimed design.

(56) **References Cited**

U.S. PATENT DOCUMENTS

D516,249 S * 2/2006 Merheje D28/60
7,062,855 B2 * 6/2006 Merheje 30/28
D559,462 S * 1/2008 Garland et al. D28/60

1 Claim, 3 Drawing Sheets

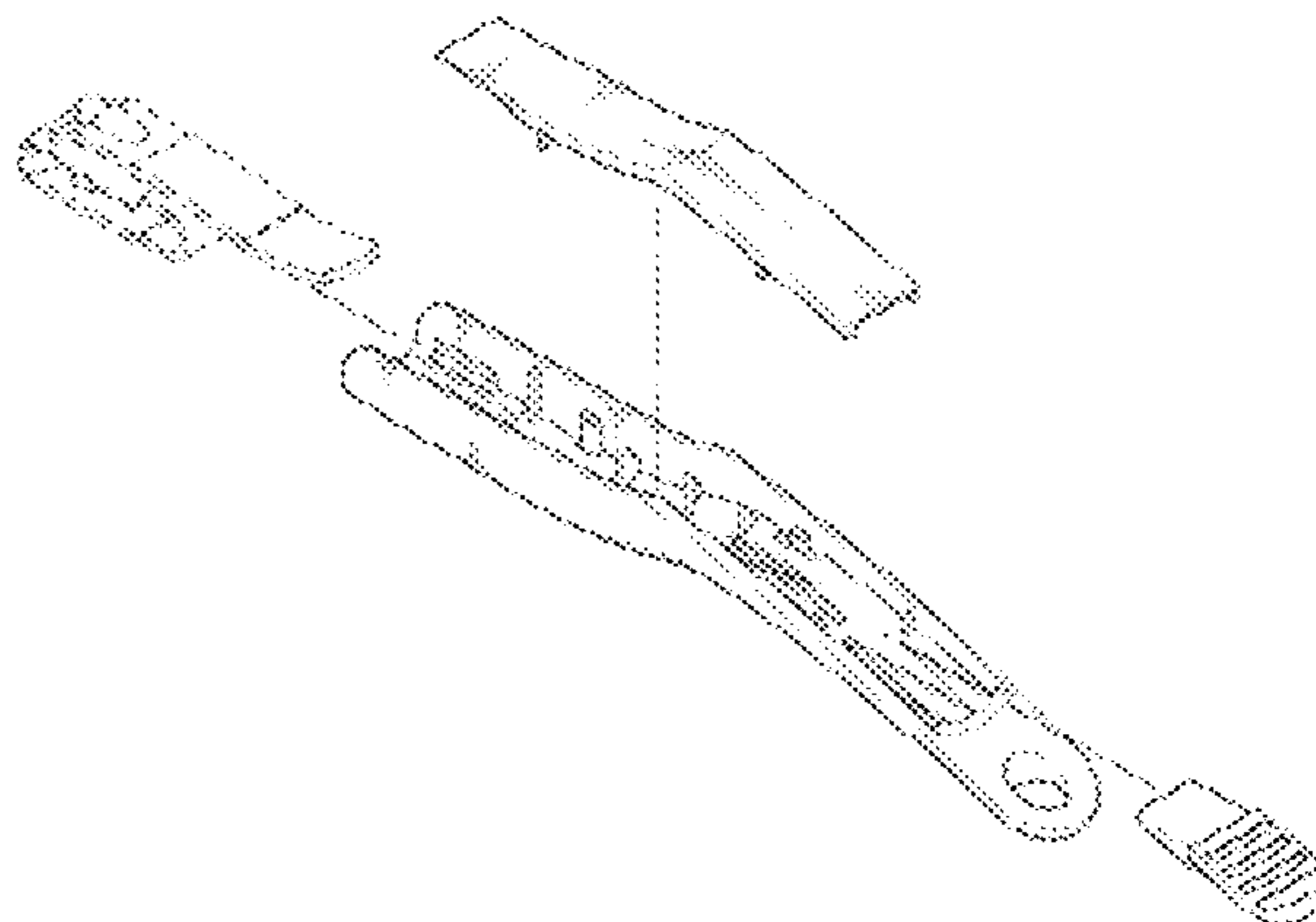
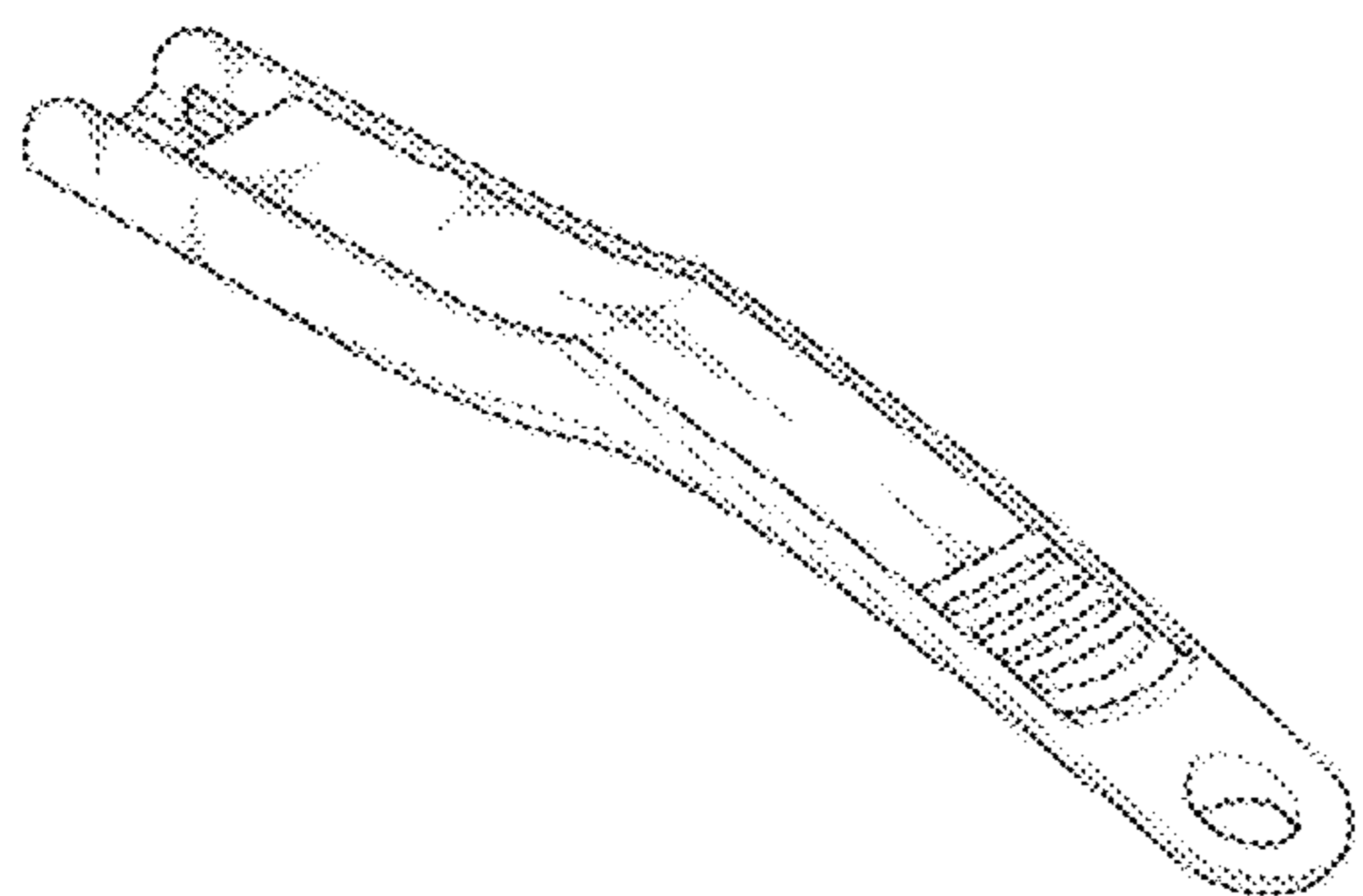

FIG. 1

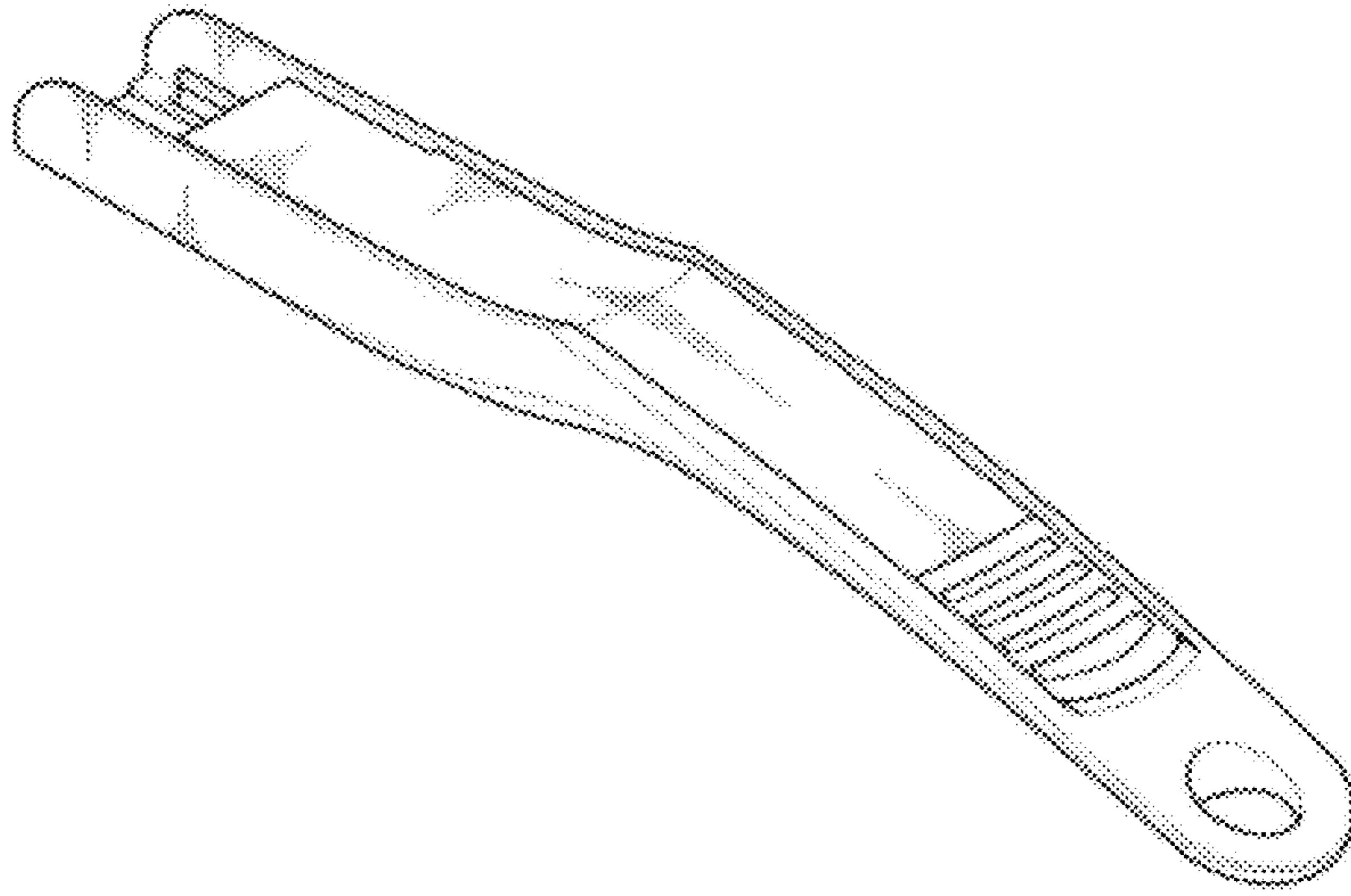

FIG. 2

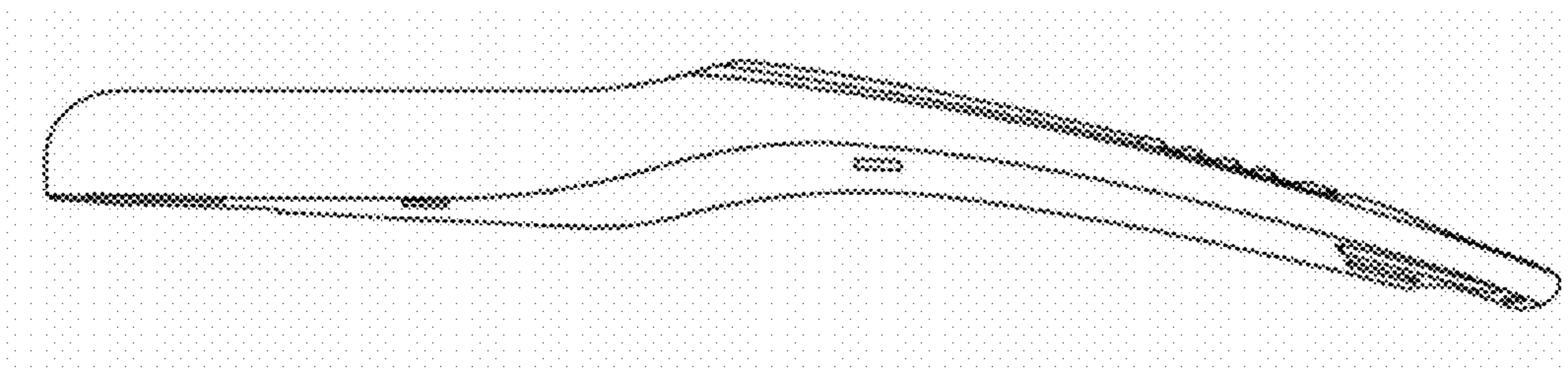

FIG. 3

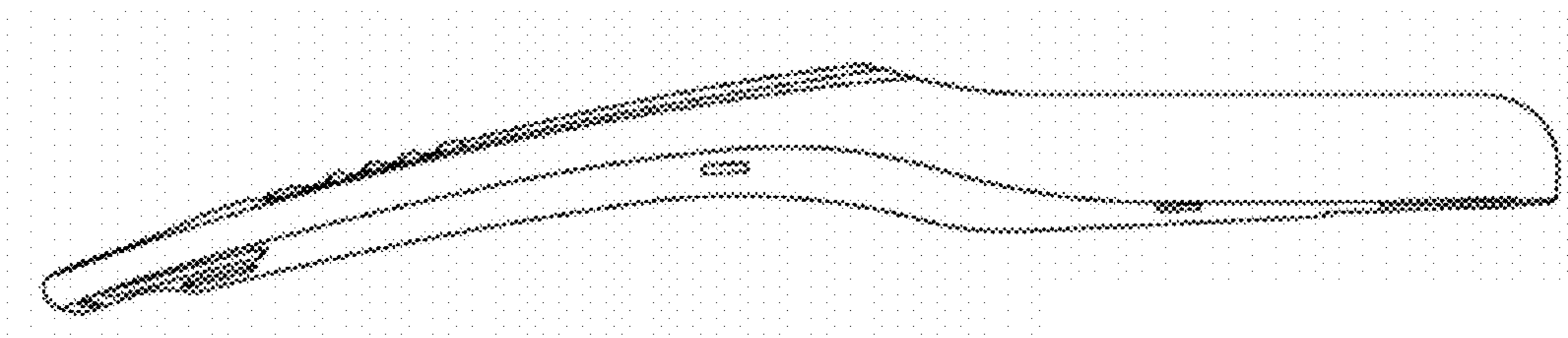

FIG. 4

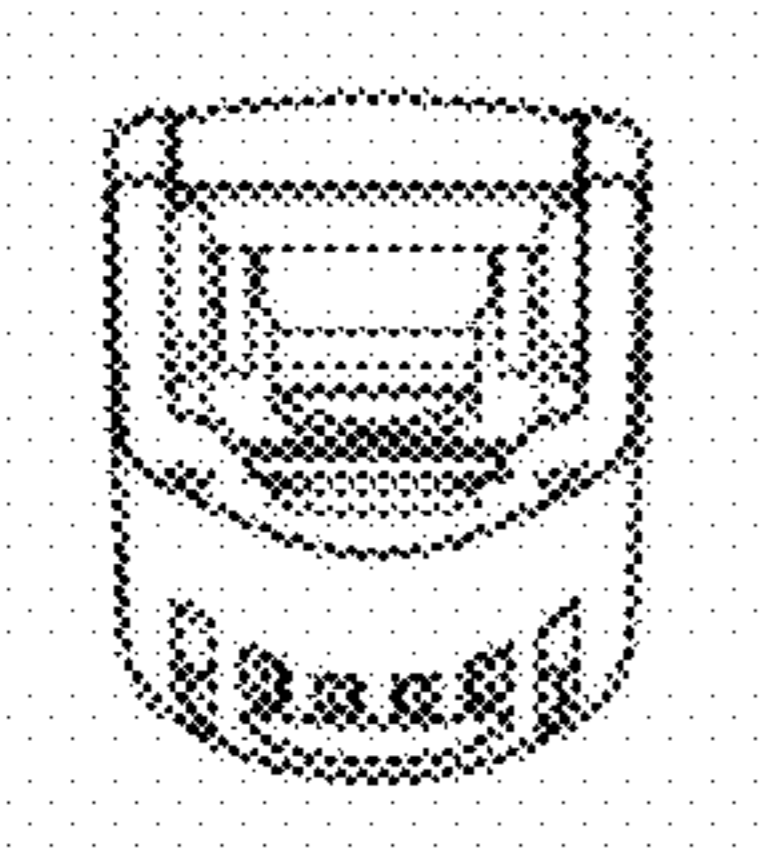

FIG. 5

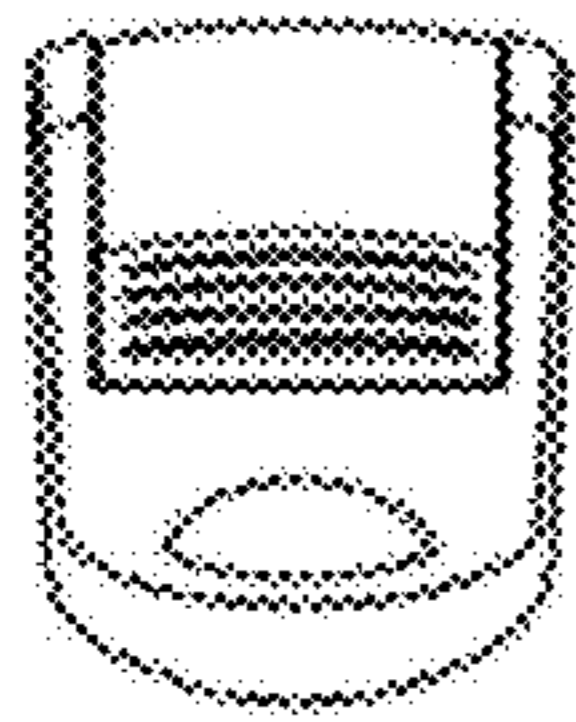

FIG. 6

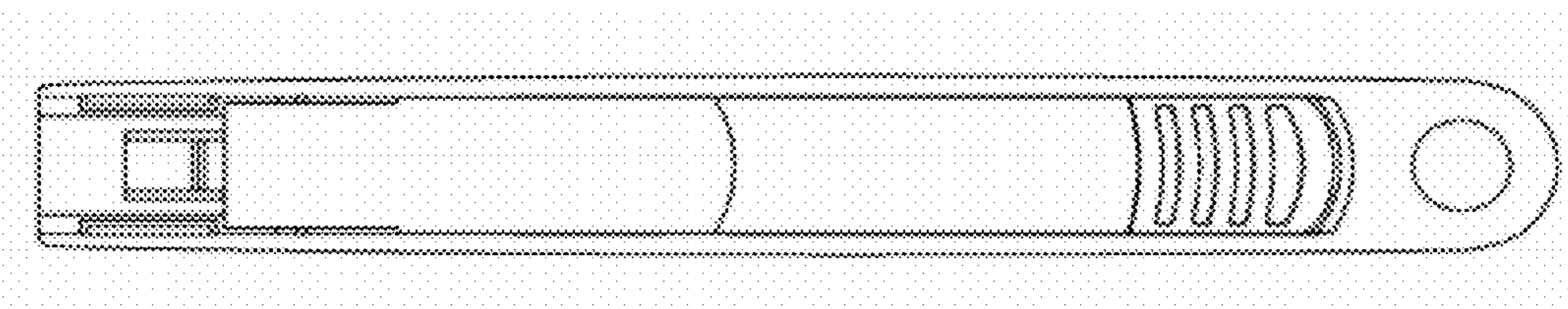

FIG. 7

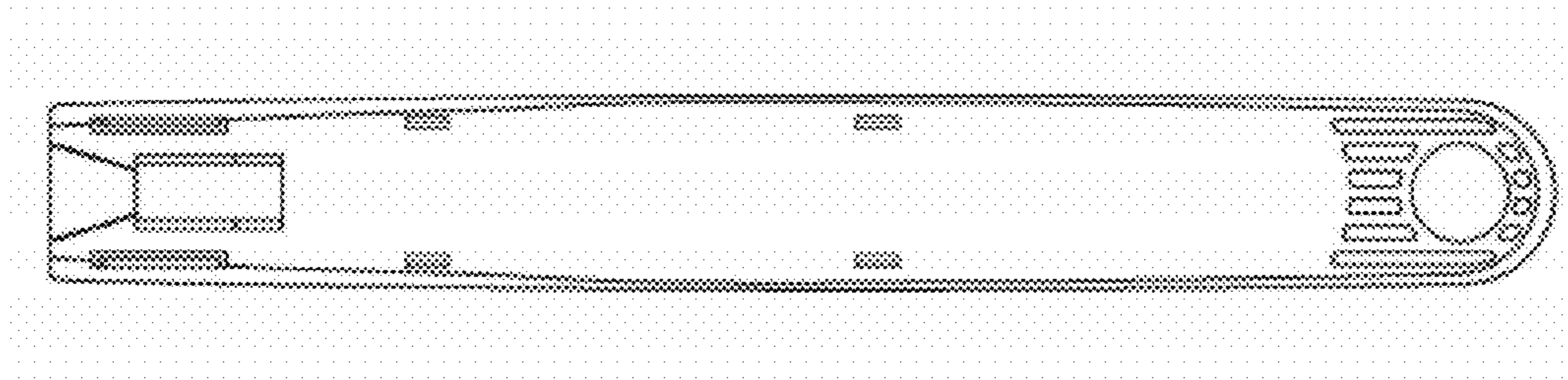

FIG. 8

