



US00D676542S

(12) **United States Design Patent**
Sinur et al.

(10) **Patent No.:** **US D676,542 S**
(45) **Date of Patent:** **** Feb. 19, 2013**

(54) **HOOD**

(75) Inventors: **Richard R. Sinur**, Grafton, WI (US);
Kiyoshi Hoshino, Pewaukee, WI (US);
Brian R. Wellnitz, Grafton, WI (US)

(73) Assignee: **Broan NuTone, LLC**, Hartford, WI
(US)

(**) Term: **14 Years**

(21) Appl. No.: **29/385,081**

(22) Filed: **Feb. 8, 2011**

(51) **LOC (9) Cl.** **23-04**

(52) **U.S. Cl.** **D23/372**

(58) **Field of Classification Search** D13/179;
D23/370-394, 411-414; D26/51, 59, 72,
D26/81-86; 34/169; 52/302.1, 302.7; 55/DIG. 36;
123/41.7; 126/58, 60, 61, 64-66, 84, 299 D-299 F,
126/299 R, 300, 301, 312, 531; 138/118,
138/121, 172, 173, 177; 165/54, 59; 285/133.6;
392/364; 415/126, 127, 213.1, 214.1; 416/5,
416/204 R, 210 R, 234, 237, 244 R, 247 R;
454/41, 42, 233, 236, 250-253, 275-277,
454/284, 309, 367, 368

See application file for complete search history.

(56) **References Cited**

U.S. PATENT DOCUMENTS

5,267,550	A *	12/1993	Jang	126/299 D
5,377,665	A *	1/1995	Jang	126/299 R
D473,297	S *	4/2003	Bothe et al.	D23/372
D521,622	S *	5/2006	Bothe et al.	D23/372
D532,507	S *	11/2006	Vetter	D23/372
D635,235	S *	3/2011	Hoshino et al.	D23/372
D659,232	S *	5/2012	Funnell, II	D23/371
2007/0256681	A1 *	11/2007	Chiang et al.	126/299 R

* cited by examiner

Primary Examiner — Garth Rademaker

(74) *Attorney, Agent, or Firm* — Greenberg Traurig LLP

(57) **CLAIM**

We claim the ornamental design for a hood, as shown and described.

DESCRIPTION

FIG. 1 is a perspective view of a hood.
FIG. 2 is a side view of the hood shown in FIG. 1.
FIG. 3 is a front view of the hood shown in FIG. 1.
FIG. 4 is a top view of the hood shown in FIG. 1;
FIG. 5 is a bottom view of the hood shown in FIG. 1; and,
FIG. 6 is a rear view of the hood shown in FIG. 1.
The broken line showing of the environment is for illustrative purposes only and forms no part of the claimed design.

1 Claim, 5 Drawing Sheets

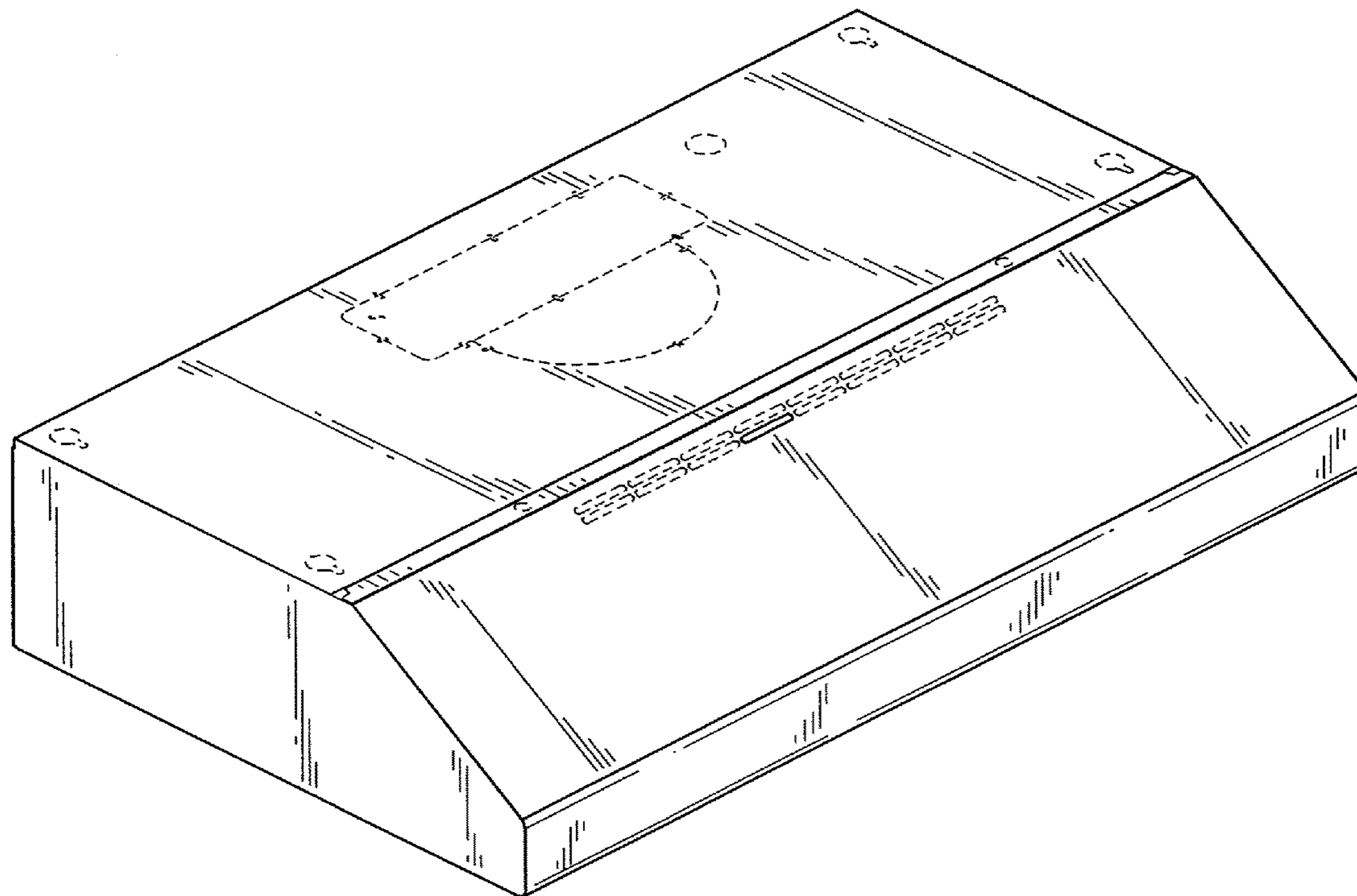

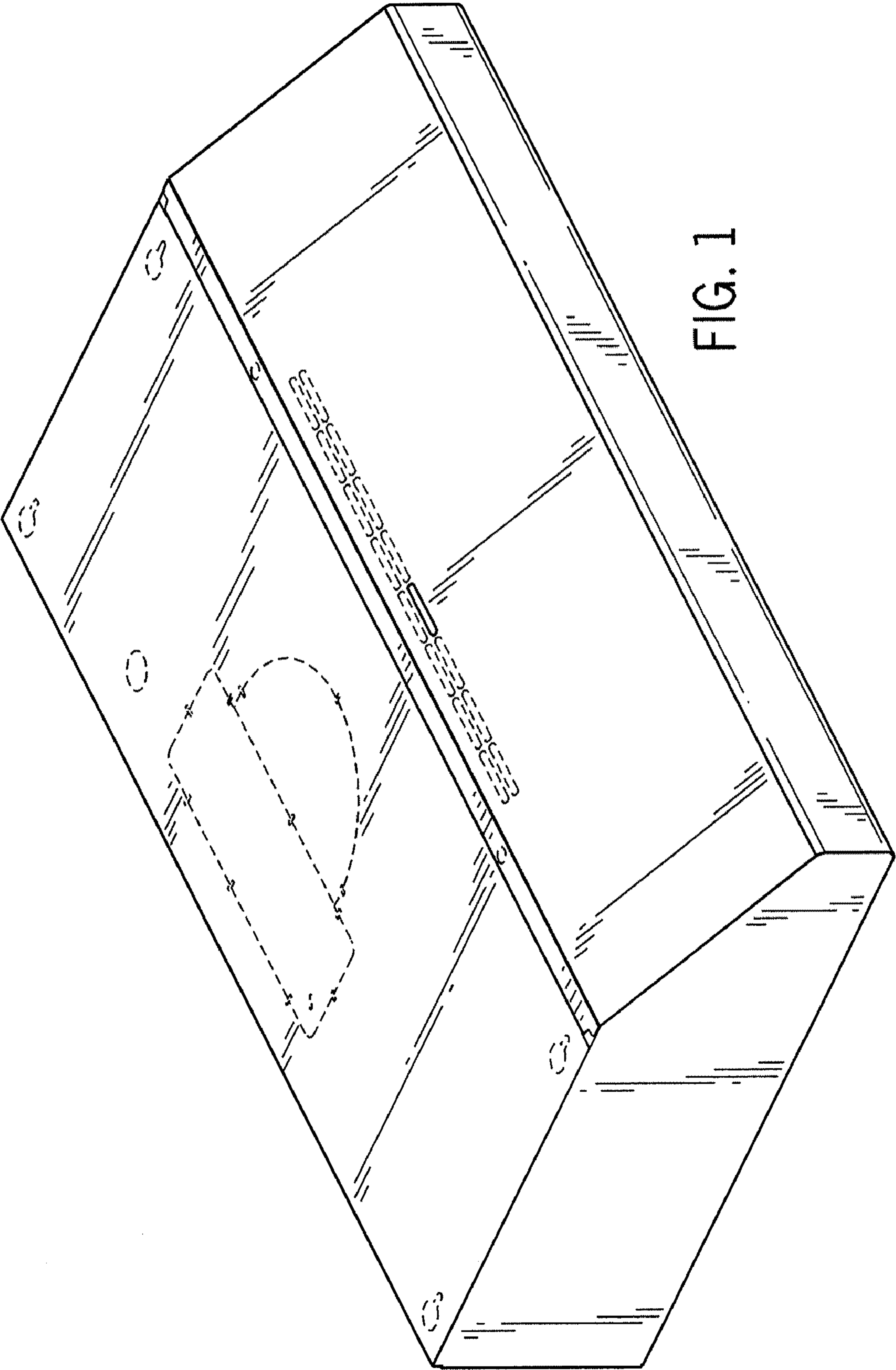

FIG. 1

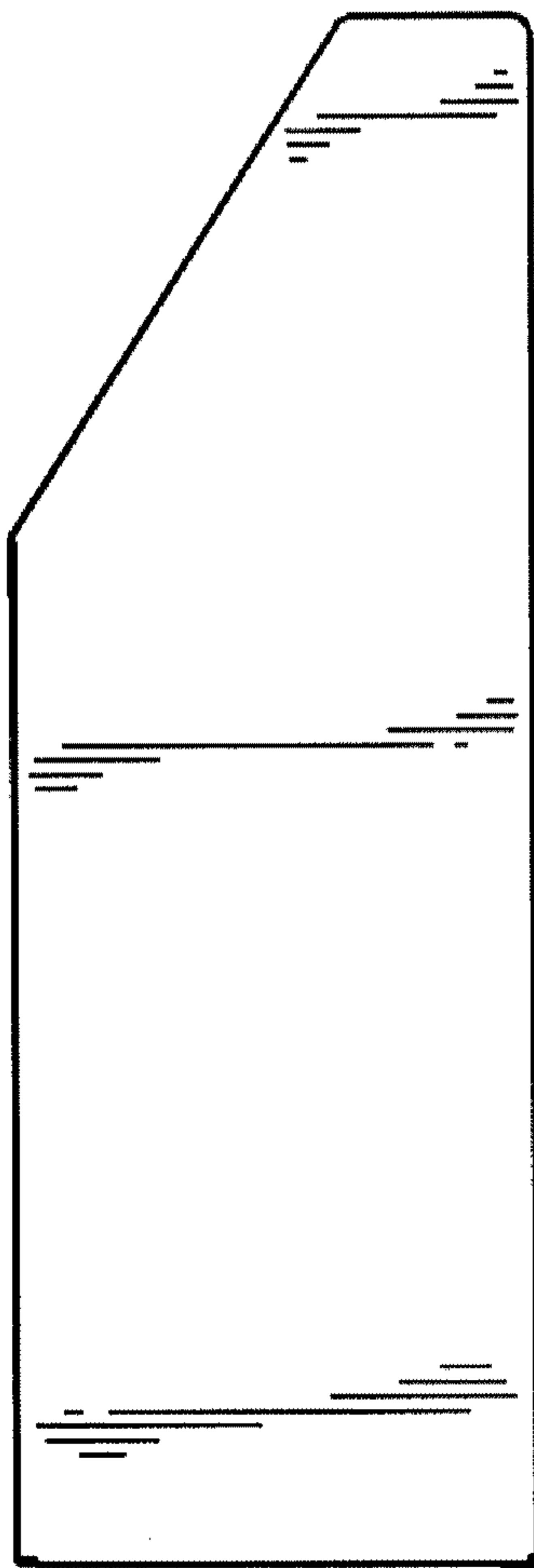

FIG. 2

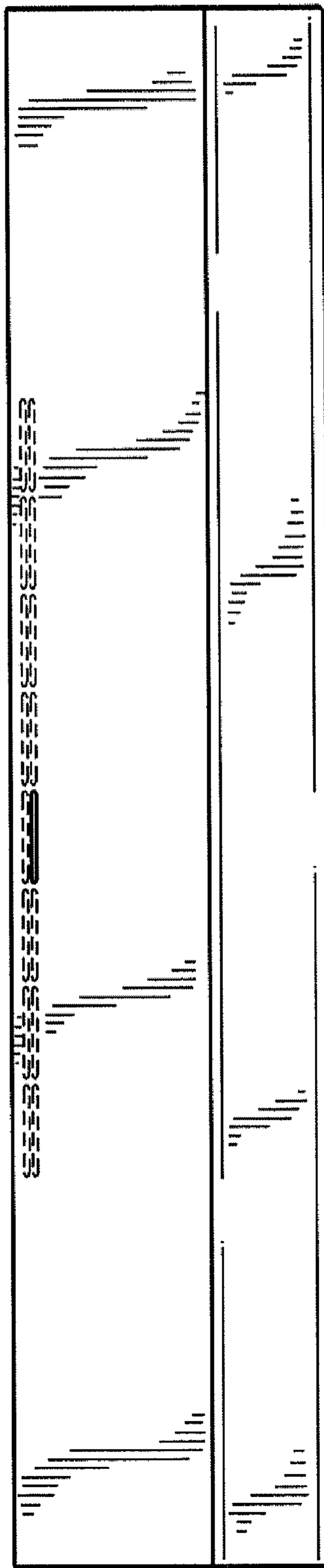

FIG. 3

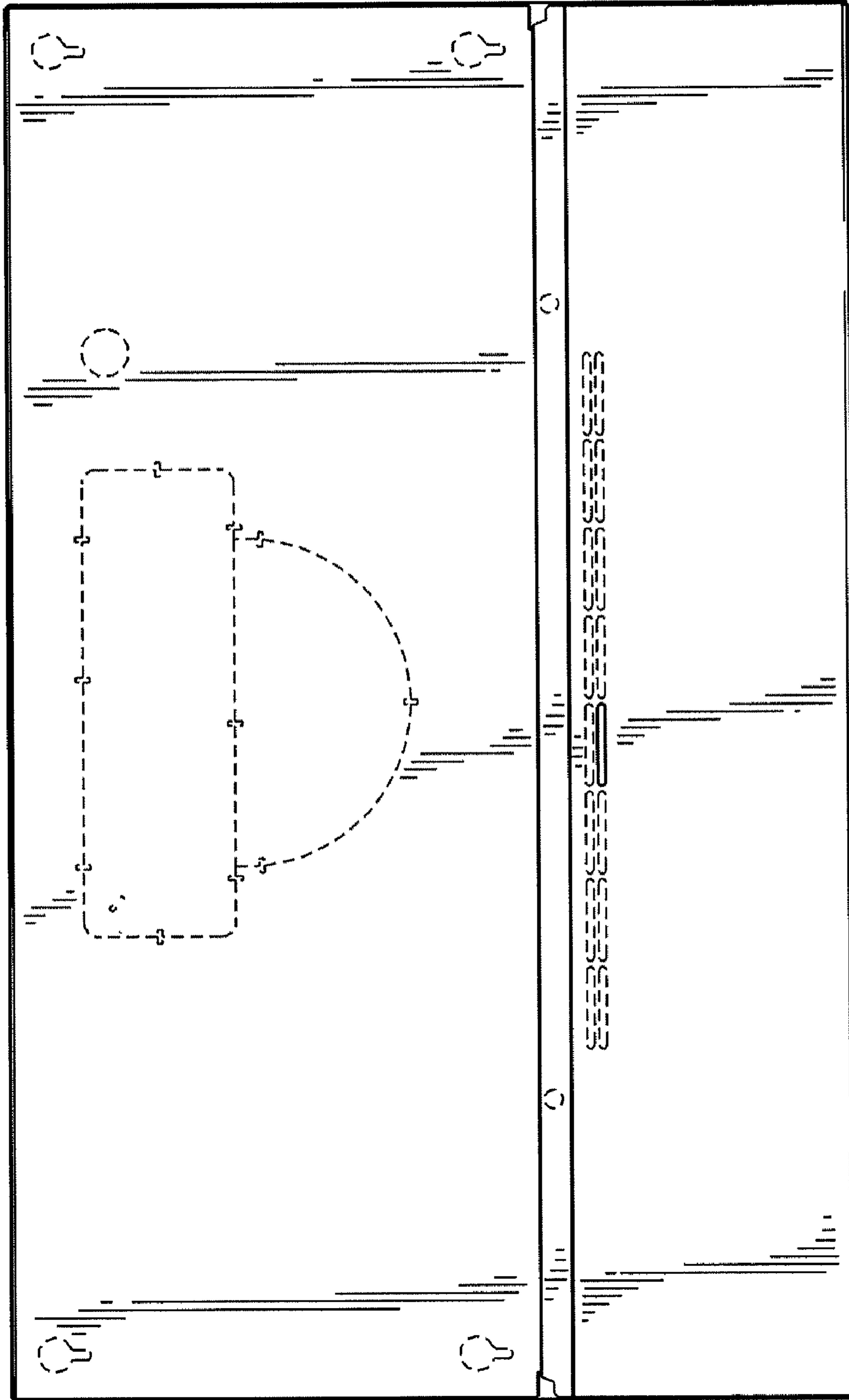

FIG. 4

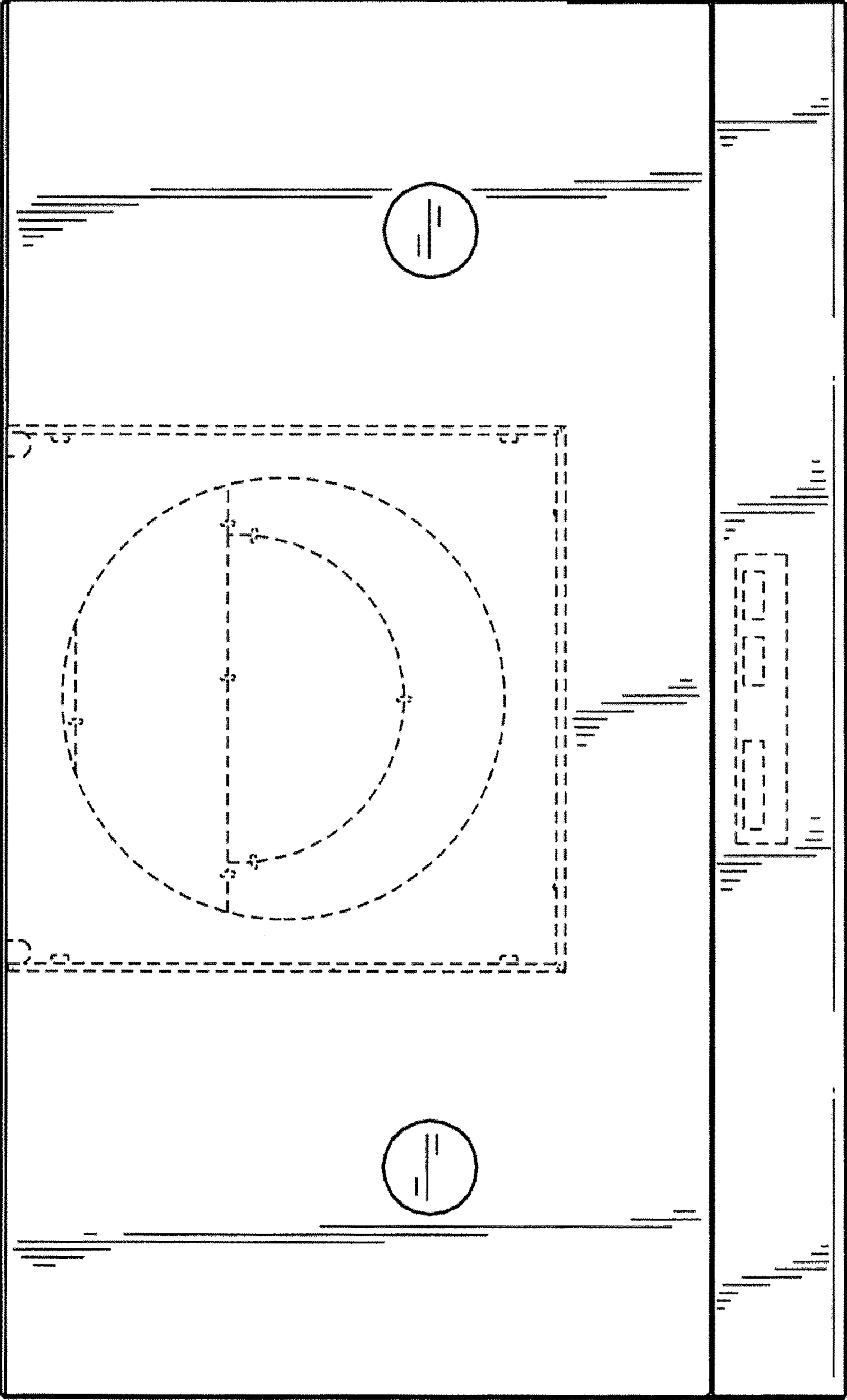

FIG. 5

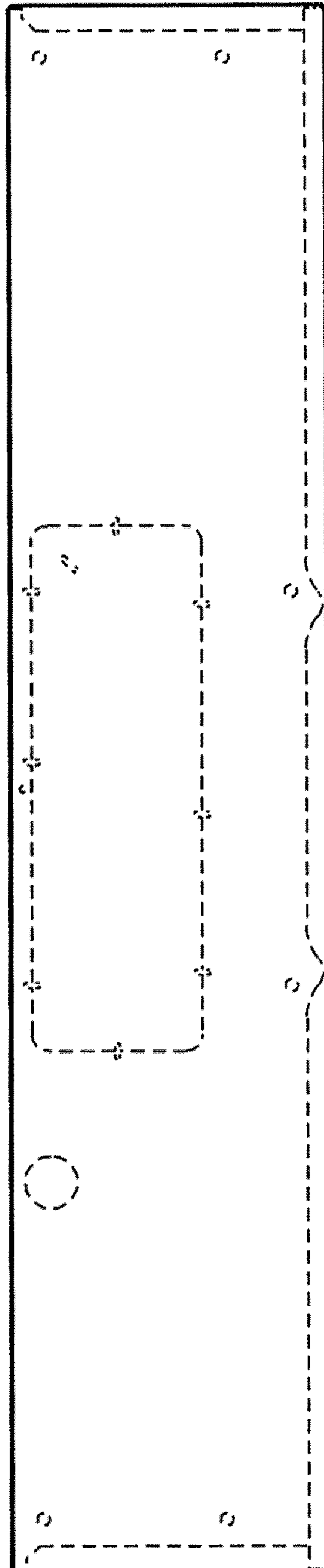

FIG. 6