



US00D676438S

(12) **United States Design Patent**
Akana et al.

(10) **Patent No.:** **US D676,438 S**
(45) **Date of Patent:** **** Feb. 19, 2013**

(54) **ELECTRONIC DEVICE**

(75) Inventors: **Jody Akana**, San Francisco, CA (US);
Bartley K. Andre, Menlo Park, CA
(US); **Jeremy Bataillou**, San Francisco,
CA (US); **Daniel J. Coster**, San
Francisco, CA (US); **Daniele De Iuliis**,
San Francisco, CA (US); **Evans**
Hankey, San Francisco, CA (US);
Julian Hoenig, San Francisco, CA (US);
Richard P. Howarth, San Francisco, CA
(US); **Jonathan P. Ive**, San Francisco,
CA (US); **Duncan Robert Kerr**, San
Francisco, CA (US); **Matthew Dean**
Rohrbach, San Francisco, CA (US);
Peter Russell-Clarke, San Francisco,
CA (US); **Mikael Silvano**, San
Francisco, CA (US); **Christopher J.**
Stringer, Woodside, CA (US); **Eugene**
Antony Whang, San Francisco, CA
(US); **Rico Zorkendorfer**, San
Francisco, CA (US)

(73) Assignee: **Apple Inc.**, Cupertino, CA (US)

(**) Term: **14 Years**

(21) Appl. No.: **29/420,873**

(22) Filed: **May 14, 2012**

(51) **LOC (9) Cl.** **14-02**

(52) **U.S. Cl.** **D14/318**

(58) **Field of Classification Search** D14/315-327;
D18/1, 2, 7, 11; 235/145 A, 145 R; 341/22,
341/23; 345/104, 156, 157, 168, 169, 173;
348/373; 361/679.5, 679.08, 679.09, 679.11,
361/679.26, 679.27, 679.49, 679.55; 715/783
See application file for complete search history.

(56) **References Cited**

U.S. PATENT DOCUMENTS

6,067,224 A * 5/2000 Nobuchi 361/679.27
D431,821 S * 10/2000 Mizuno D14/318

D493,785 S * 8/2004 Andre et al. D14/318
D517,063 S * 3/2006 Nakajima et al. D14/318
D523,429 S * 6/2006 Lin D14/318
D524,306 S * 7/2006 Yun et al. D14/315
D526,999 S * 8/2006 Tago D14/327
D533,550 S * 12/2006 Yamada D14/318
D571,364 S * 6/2008 Andre et al. D14/315
D572,246 S * 7/2008 Andre et al. D14/315
D604,290 S 11/2009 Andre et al.
D604,291 S 11/2009 Andre et al.
D604,292 S 11/2009 Andre et al.
D604,293 S 11/2009 Andre et al.
D606,988 S 12/2009 Andre et al.
D606,989 S 12/2009 Andre et al.
D611,045 S 3/2010 Andre et al.
D617,789 S 6/2010 Akana et al.
D621,825 S 8/2010 Andre et al.
D623,645 S 9/2010 Andre et al.
D633,087 S 2/2011 Andre et al.
D642,172 S 7/2011 Akana et al.
D642,560 S 8/2011 Akana et al.
D648,333 S 11/2011 Andre et al.
D648,334 S 11/2011 Andre et al.
D652,032 S 1/2012 Akana et al.
D655,704 S 3/2012 Akana et al.
D657,786 S 4/2012 Andre et al.
D661,296 S 6/2012 Akana et al.
D662,497 S 6/2012 Akana et al.
2005/0018396 A1 * 1/2005 Nakajima et al. 361/683
2005/0041378 A1 * 2/2005 Hamada et al. 361/680

* cited by examiner

Primary Examiner — Freda S Nunn

(74) *Attorney, Agent, or Firm* — SAIDMAN DesignLaw
Group

(57) **CLAIM**

The ornamental design for an electronic device, as shown and
described.

DESCRIPTION

FIG. 1 is a top, front perspective view of a first embodiment of
an electronic device showing our new design;
FIG. 2 is a bottom, rear perspective thereof;
FIG. 3 is front view thereof;
FIG. 4 is rear view thereof;
FIG. 5 is a left side view thereof;
FIG. 6 is a right side view thereof;

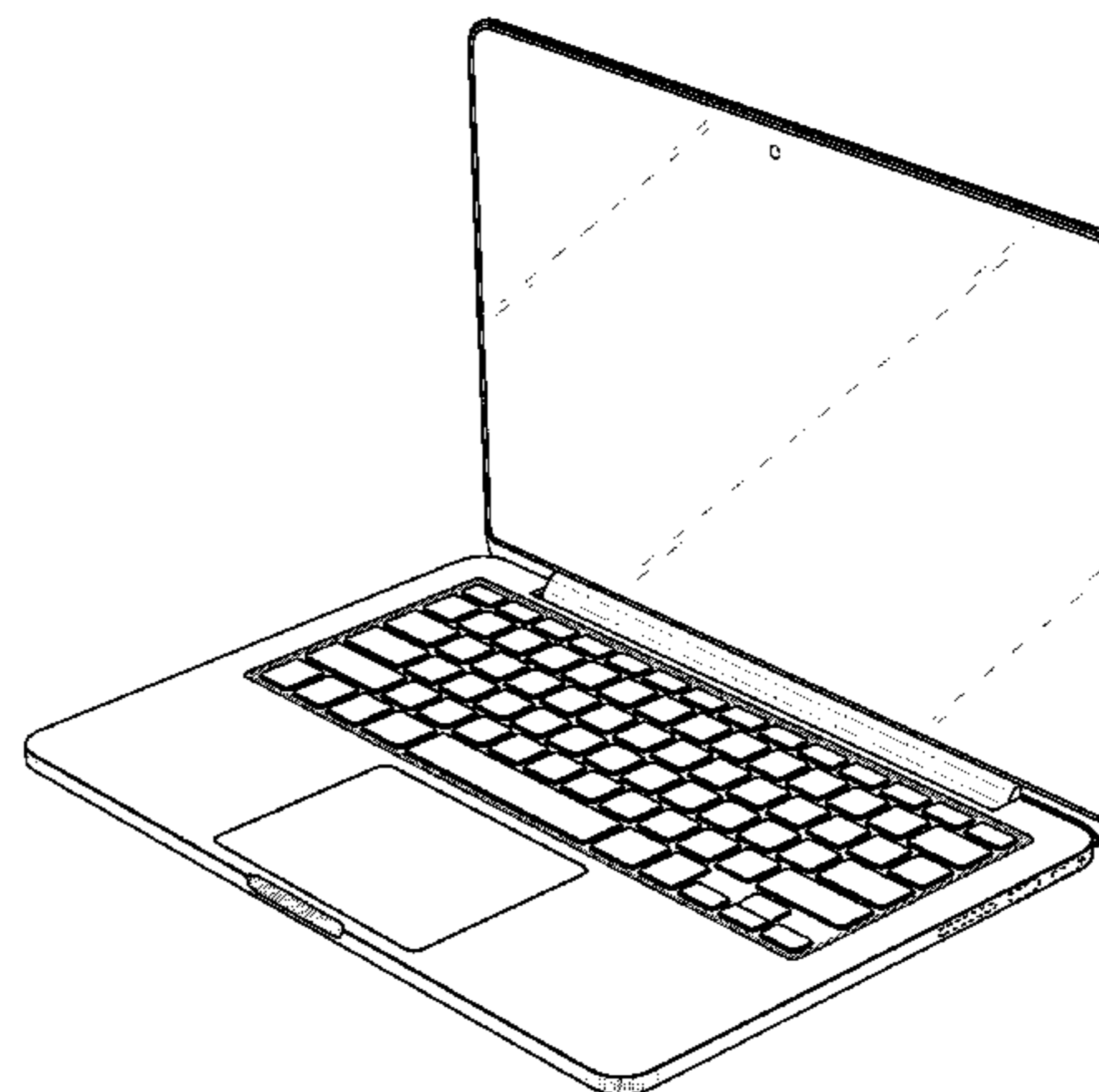
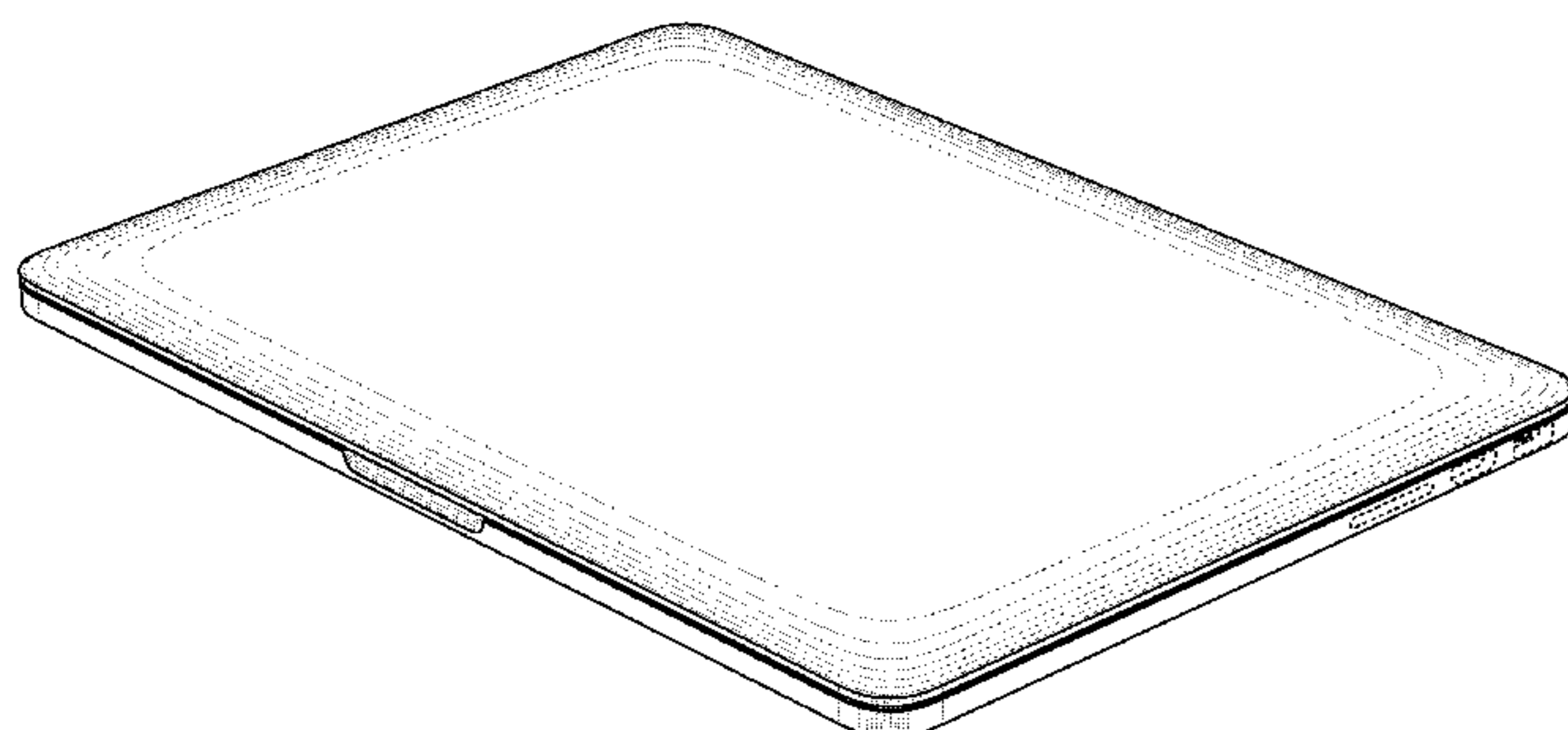

FIG. 7 is a top view thereof;
 FIG. 8 is a bottom view thereof;
 FIG. 9 is an additional top, front perspective view thereof, with the electronic device shown in an open position;
 FIG. 10 is an additional bottom, rear perspective view thereof, with the electronic device shown in an open position;
 FIG. 11 is an additional front view thereof, with the electronic device shown in an open position;
 FIG. 12 is an additional rear view thereof, with the electronic device shown in an open position;
 FIG. 13 is an additional left side view thereof, with the electronic device shown in an open position;
 FIG. 14 is an additional right side view thereof, with the electronic device shown in an open position;
 FIG. 15 is an additional top view thereof, with the electronic device shown in an open position;
 FIG. 16 is an additional bottom view thereof, with the electronic device shown in an open position;
 FIG. 17 is a top, front perspective view of a second embodiment of an electronic device showing our new design;
 FIG. 18 is a bottom, rear perspective thereof;
 FIG. 19 is front view thereof;
 FIG. 20 is rear view thereof;
 FIG. 21 is a left side view thereof;
 FIG. 22 is a right side view thereof;
 FIG. 23 is a top view thereof;
 FIG. 24 is a bottom view thereof;
 FIG. 25 is an additional top, front perspective view thereof, with the electronic device shown in an open position;
 FIG. 26 is an additional bottom, rear perspective view thereof, with the electronic device shown in an open position;
 FIG. 27 is an additional front view thereof, with the electronic device shown in an open position;
 FIG. 28 is an additional rear view thereof, with the electronic device shown in an open position;
 FIG. 29 is an additional left side view thereof, with the electronic device shown in an open position;
 FIG. 30 is an additional right side view thereof, with the electronic device shown in an open position;
 FIG. 31 is an additional top view thereof, with the electronic device shown in an open position;
 FIG. 32 is an additional bottom view thereof, with the electronic device shown in an open position;
 FIG. 33 is a top, front perspective view of a third embodiment of an electronic device showing our new design;
 FIG. 34 is a bottom, rear perspective thereof;
 FIG. 35 is front view thereof;
 FIG. 36 is rear view thereof;
 FIG. 37 is a left side view thereof;
 FIG. 38 is a right side view thereof;

FIG. 39 is a top view thereof;
 FIG. 40 is a bottom view thereof;
 FIG. 41 is an additional top, front perspective view thereof, with the electronic device shown in an open position;
 FIG. 42 is an additional bottom, rear perspective view thereof, with the electronic device shown in an open position;
 FIG. 43 is an additional front view thereof, with the electronic device shown in an open position;
 FIG. 44 is an additional rear view thereof, with the electronic device shown in an open position;
 FIG. 45 is an additional left side view thereof, with the electronic device shown in an open position;
 FIG. 46 is an additional right side view thereof, with the electronic device shown in an open positions;
 FIG. 47 is an additional top view thereof, with the electronic device shown in an open position;
 FIG. 48 is an additional bottom view thereof, with the electronic device shown in an open position;
 FIG. 49 is a top, front perspective view of a fourth embodiment of an electronic device showing our new design;
 FIG. 50 is a bottom, rear perspective thereof;
 FIG. 51 is front view thereof;
 FIG. 52 is rear view thereof;
 FIG. 53 is a left side view thereof;
 FIG. 54 is a right side view thereof;
 FIG. 55 is a top view thereof;
 FIG. 56 is a bottom view thereof;
 FIG. 57 is an additional top, front perspective view thereof, with the electronic device shown in an open position;
 FIG. 58 is an additional bottom, rear perspective view thereof, with the electronic device shown in an open position;
 FIG. 59 is an additional front view thereof, with the electronic device shown in an open position;
 FIG. 60 is an additional rear view thereof, with the electronic device shown in an open position;
 FIG. 61 is an additional left side view thereof, with the electronic device shown in an open position;
 FIG. 62 is an additional right side view thereof, with the electronic device shown in an open position;
 FIG. 63 is an additional top view thereof, with the electronic device shown in an open position; and,
 FIG. 64 is an additional bottom view thereof, with the electronic device shown in an open position.
 The broken lines are for the purpose of illustrating portions of the electronic device and form no part of the claimed design. The relatively light gray shade lines on the surface portions indicate contour and not surface decoration. The speaker grills to the left and right of the keyboard in embodiment two and four are illustrated in broken lines.

1 Claim, 48 Drawing Sheets

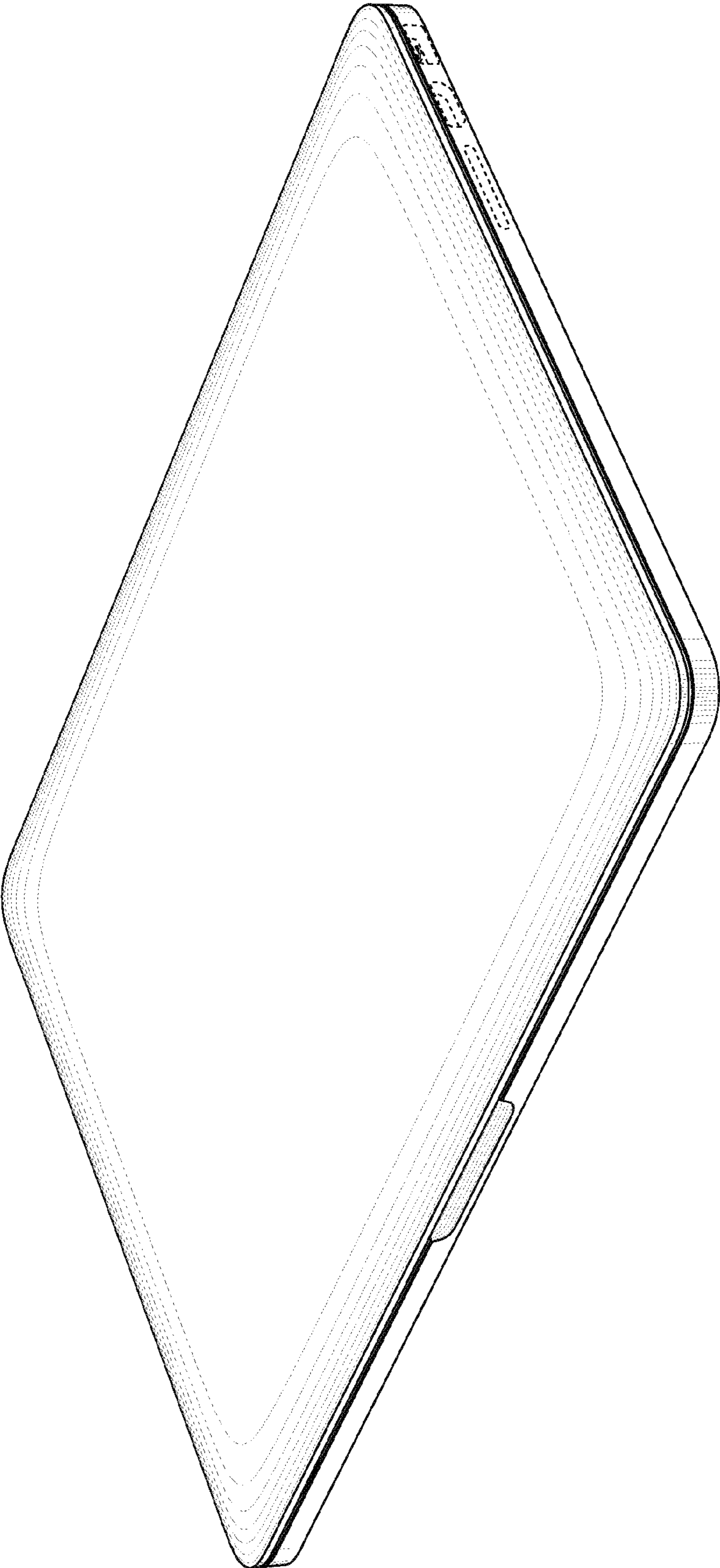

Fig. 1

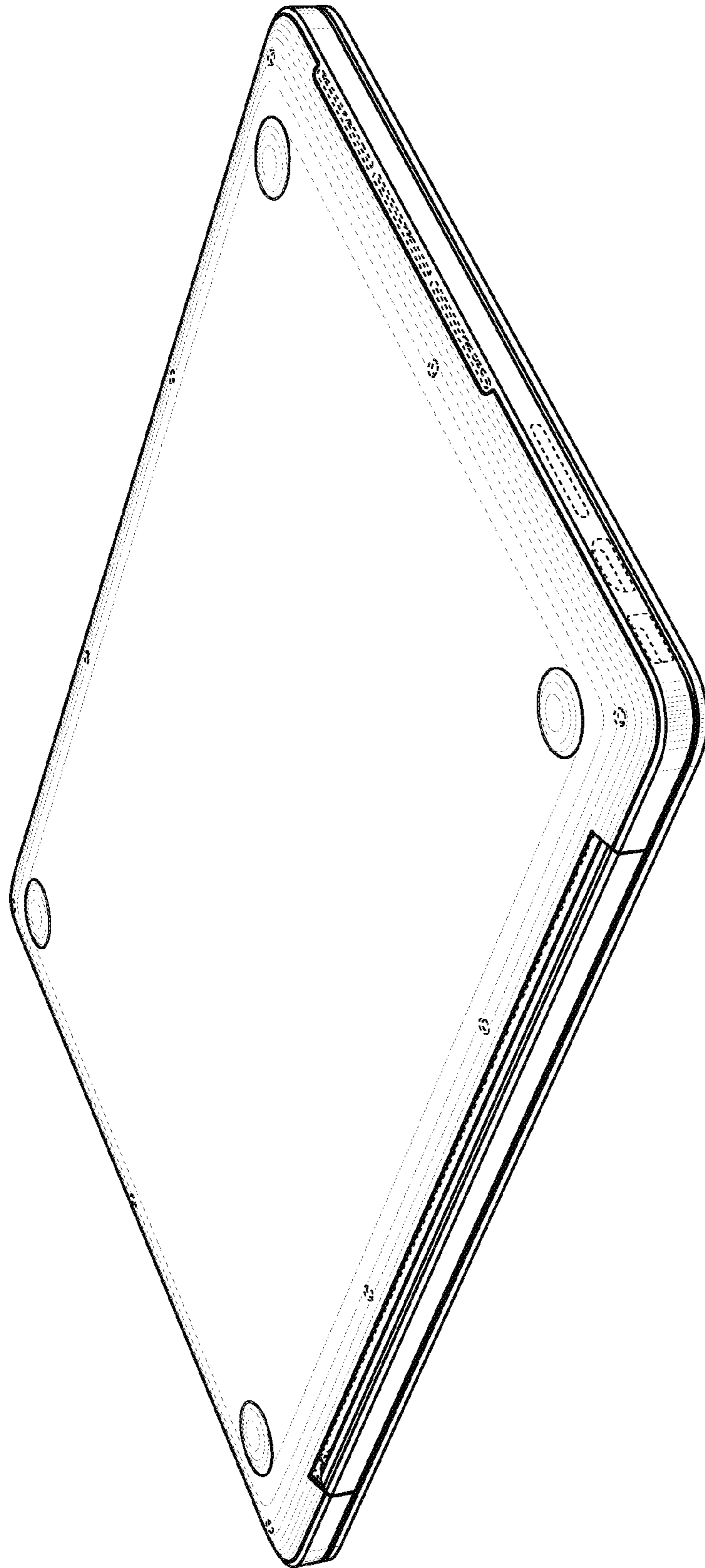

Fig. 2

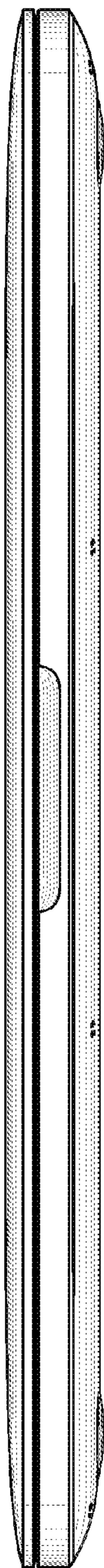

Fig. 3

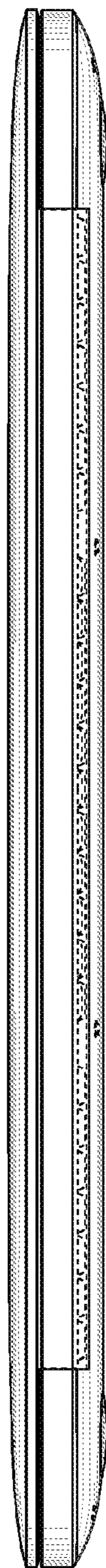

Fig. 4

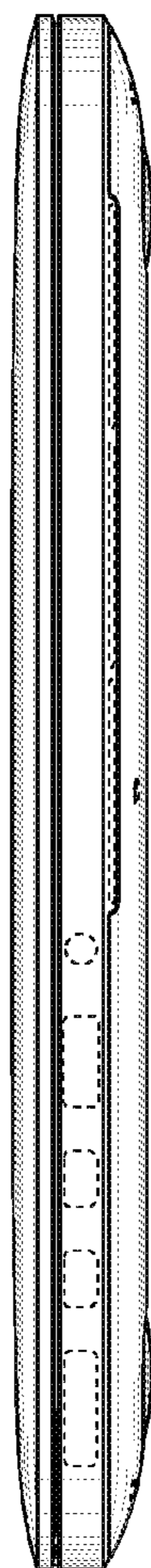

Fig. 5

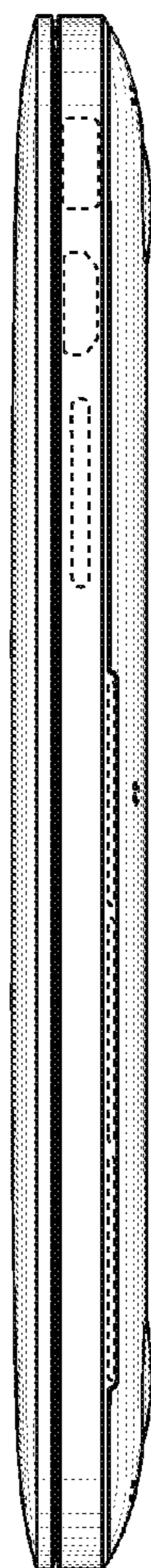

Fig. 6

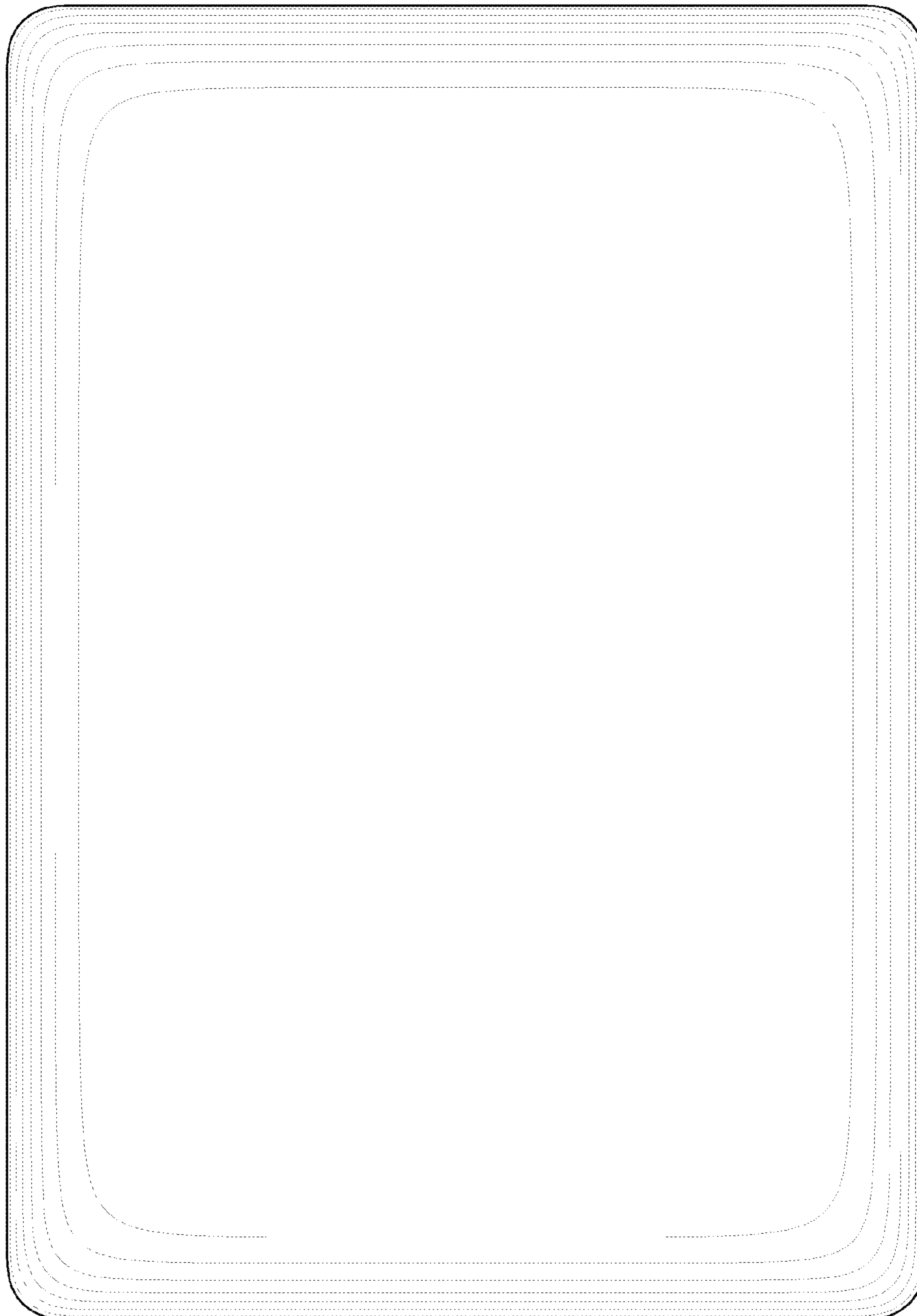

Fig. 7

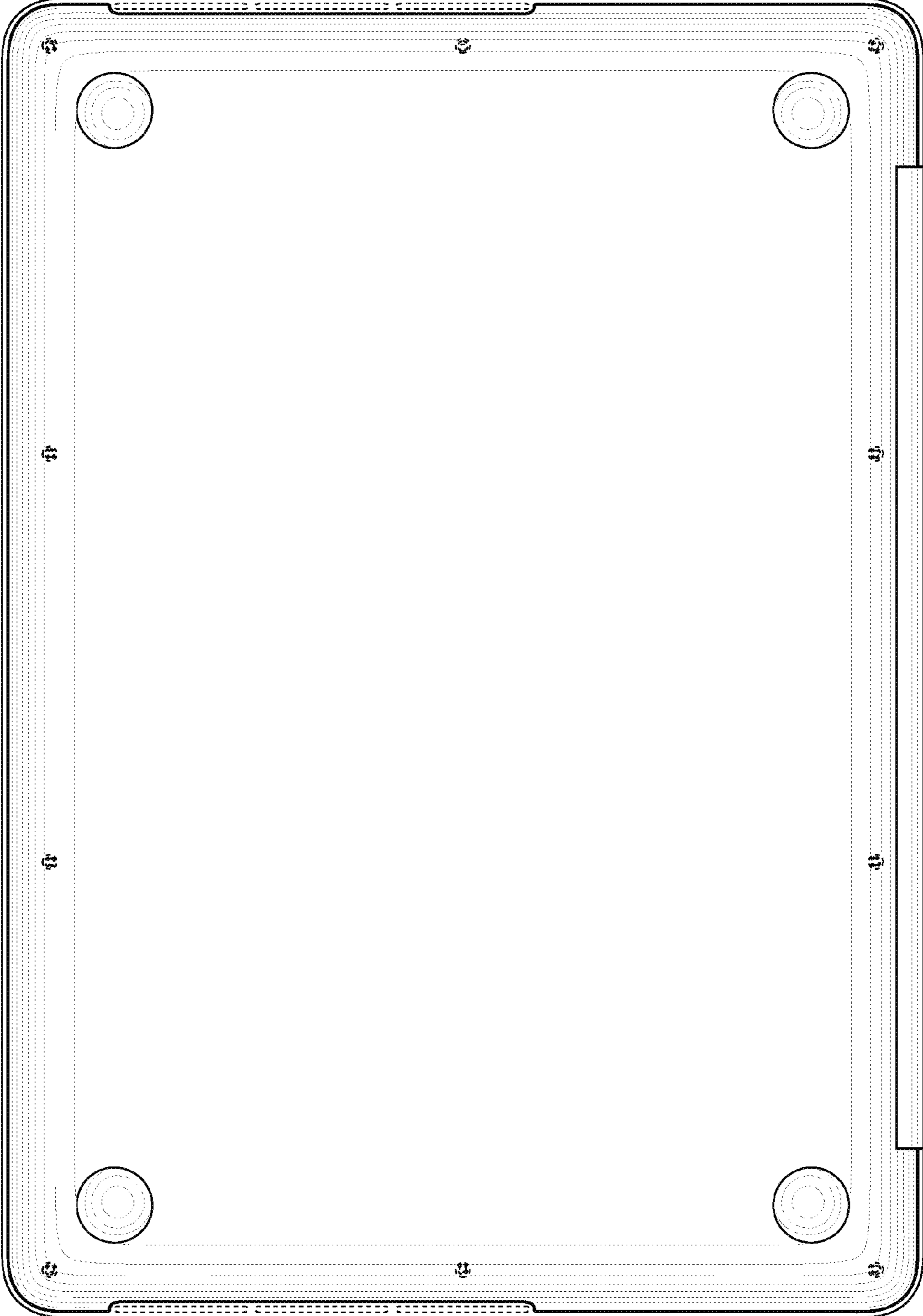

Fig. 8

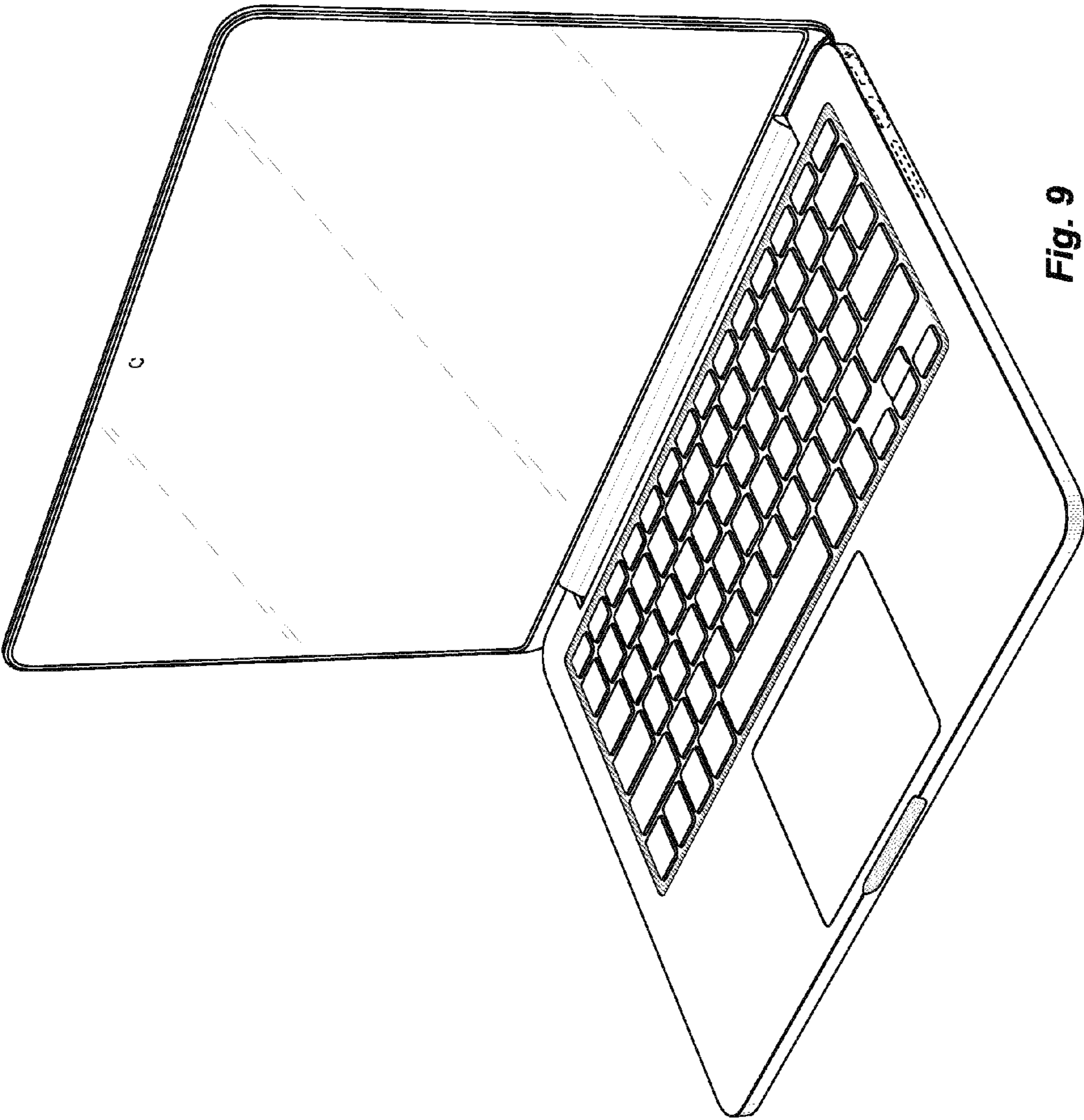

Fig. 9

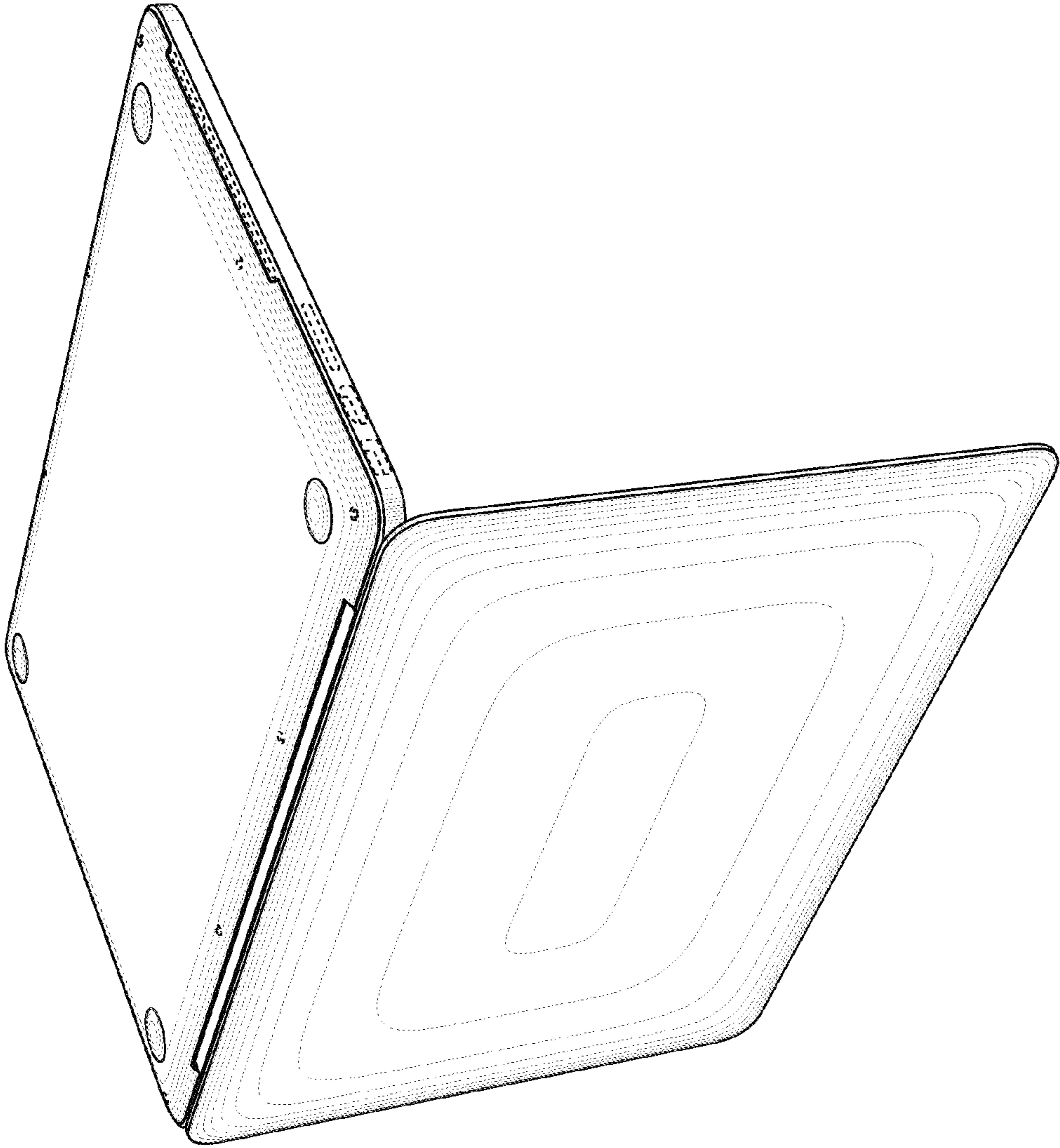

Fig. 10

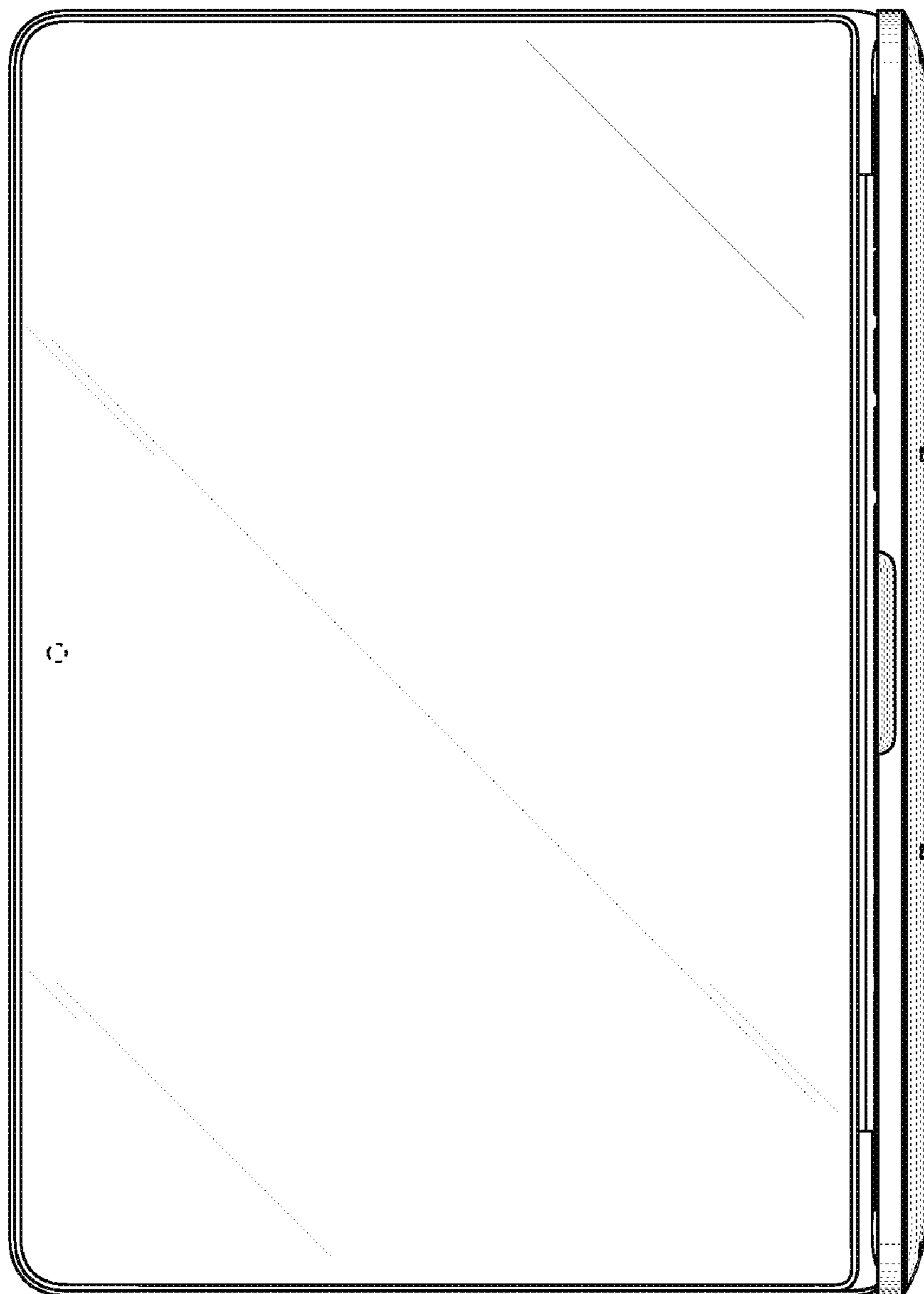

Fig. 11

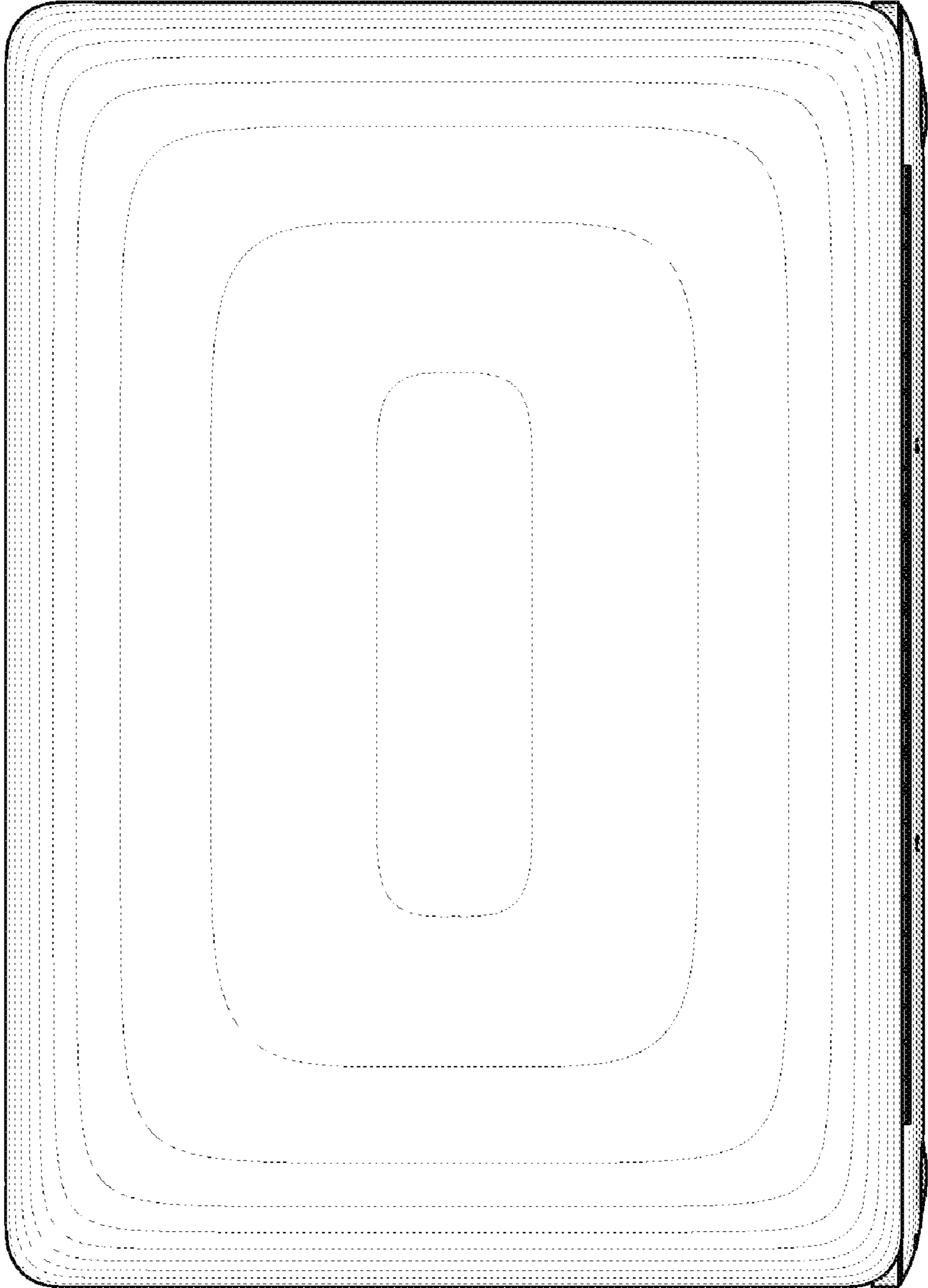

Fig. 12

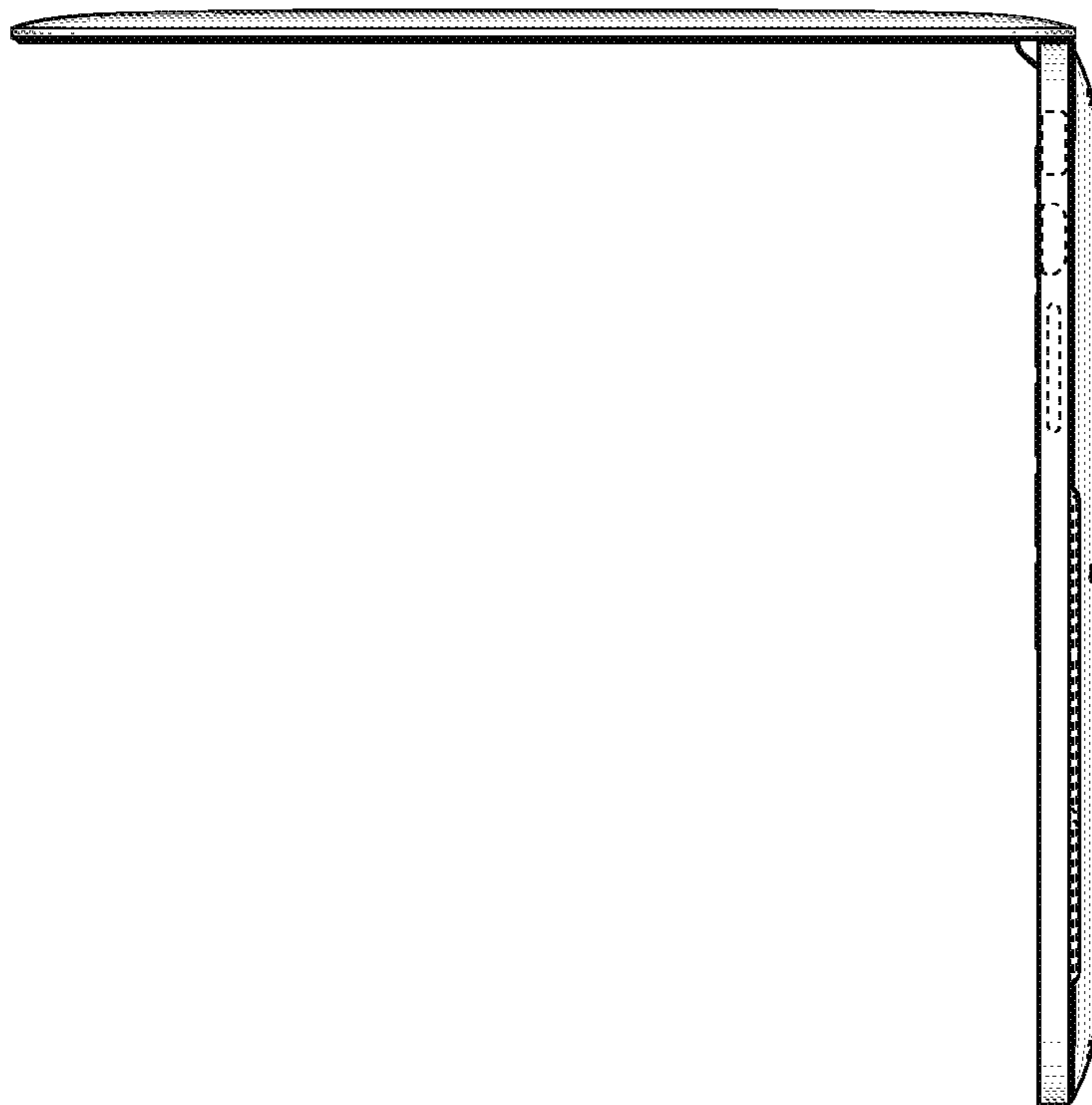

Fig. 14

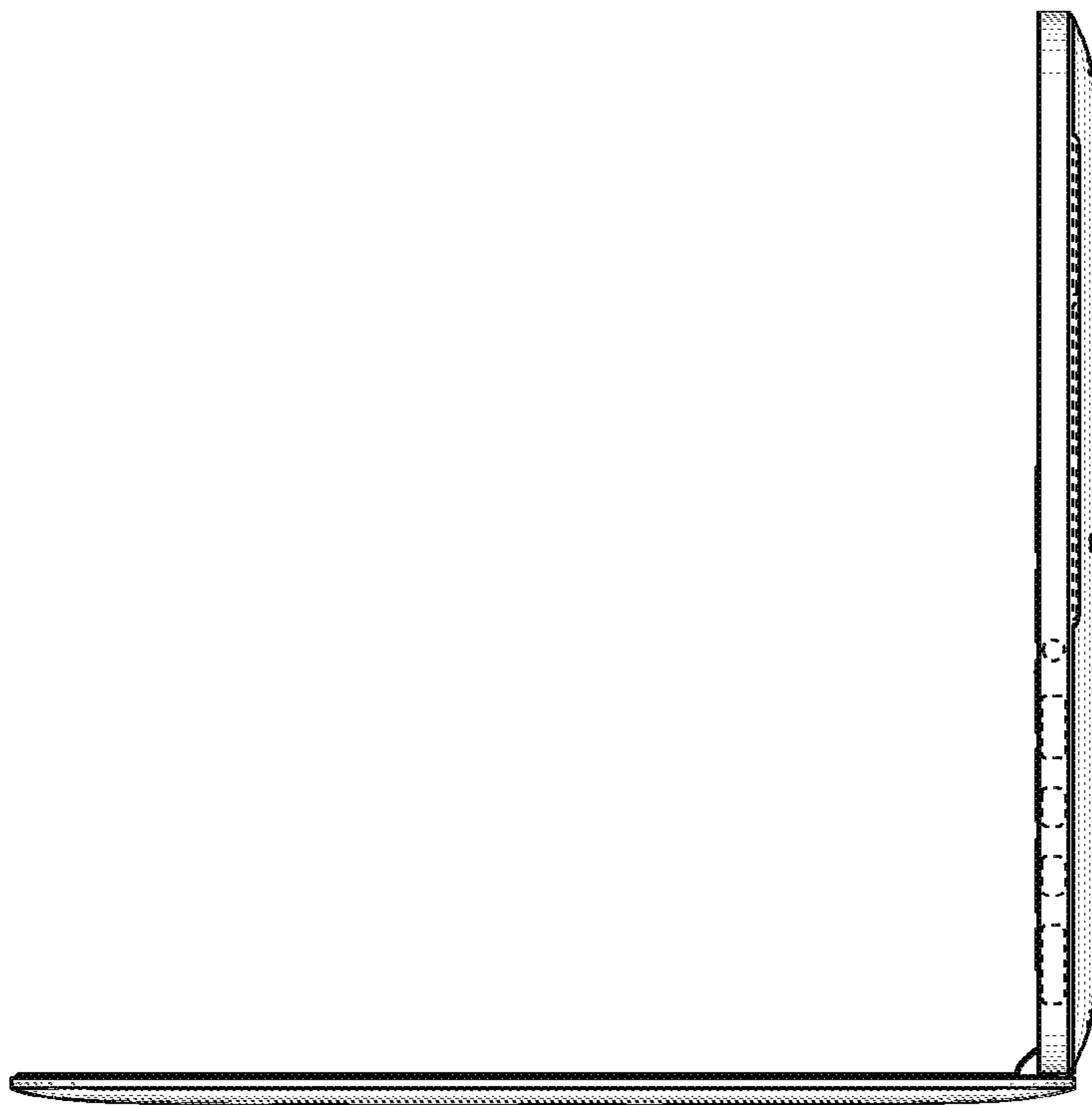

Fig. 13

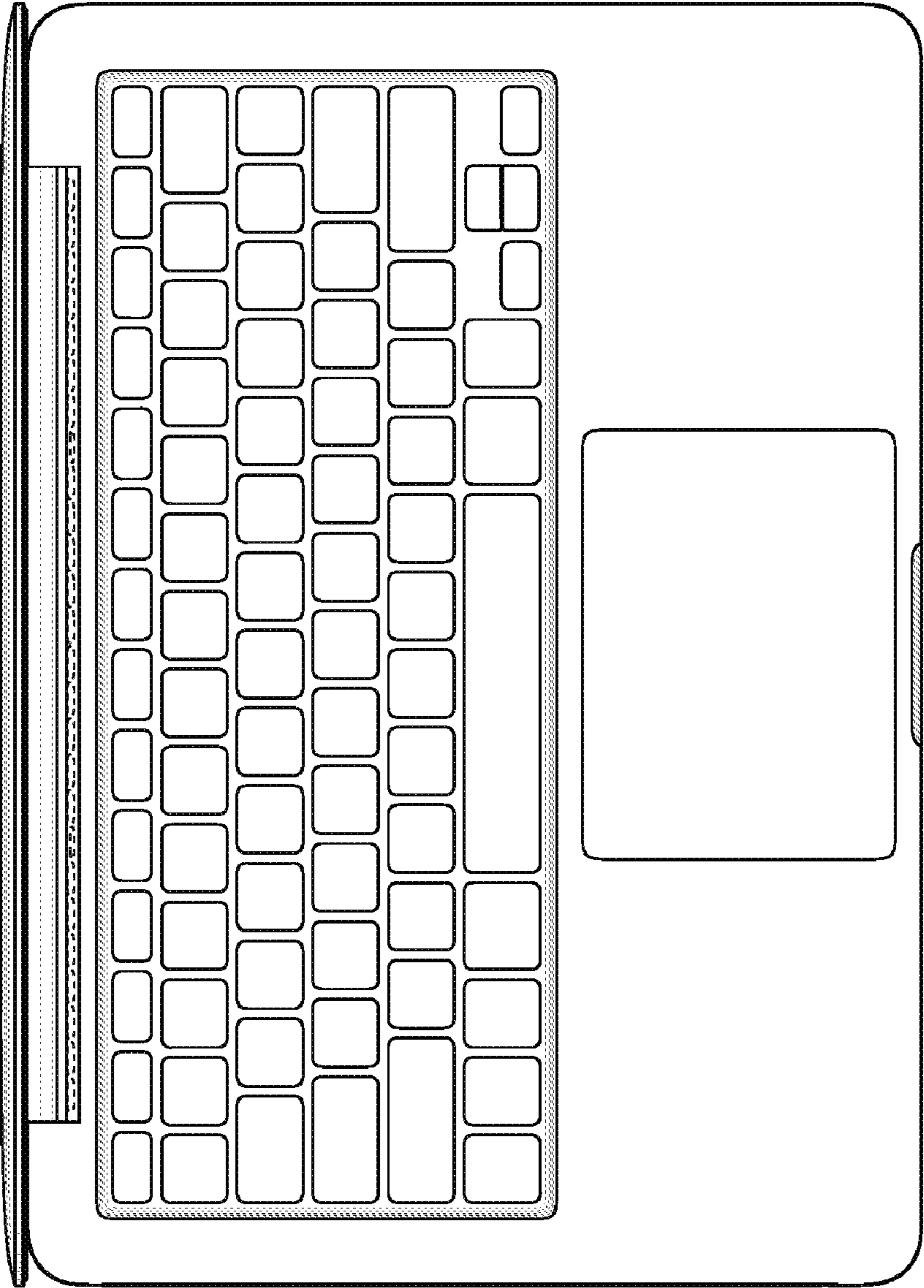

Fig. 15

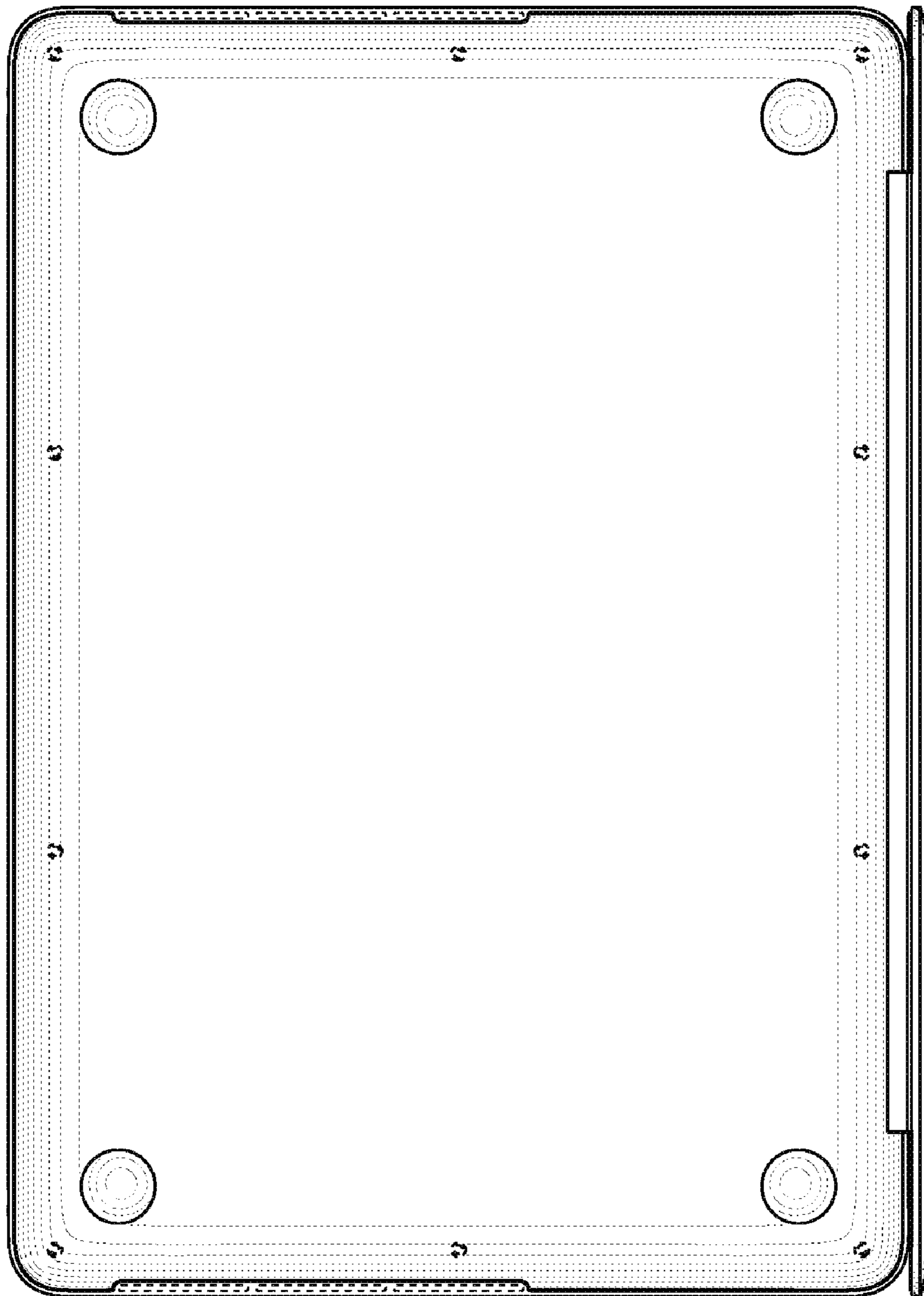

Fig. 16

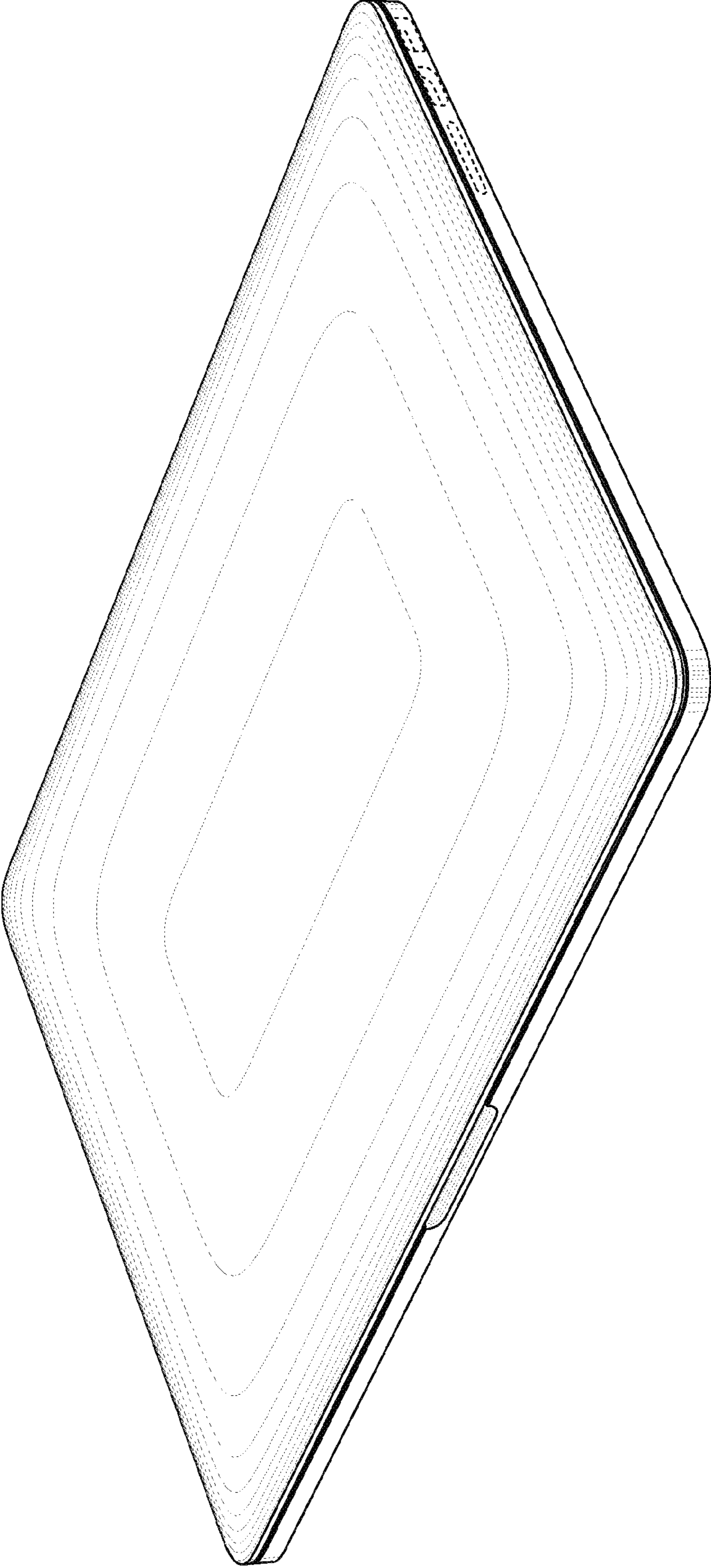

Fig. 17

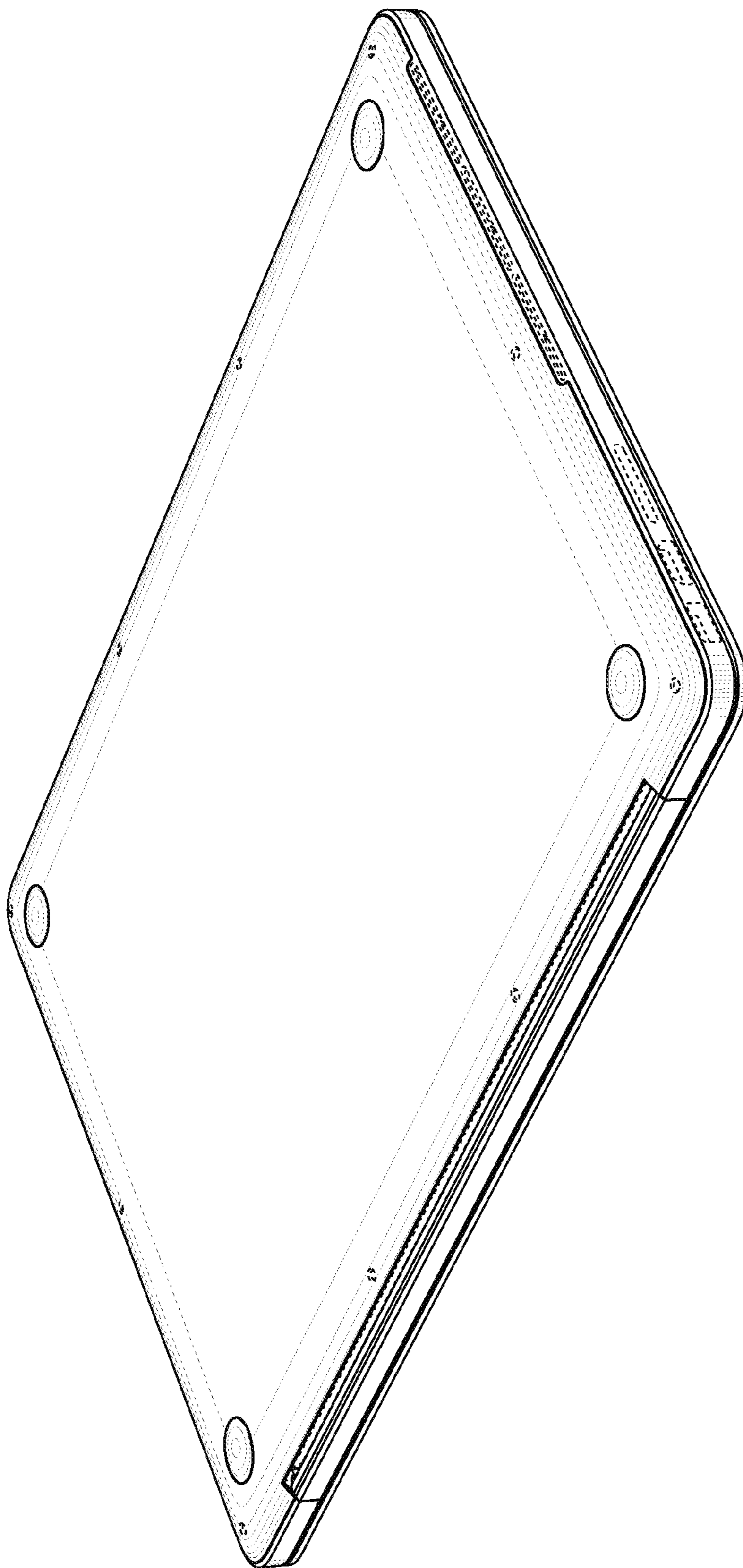

Fig. 18

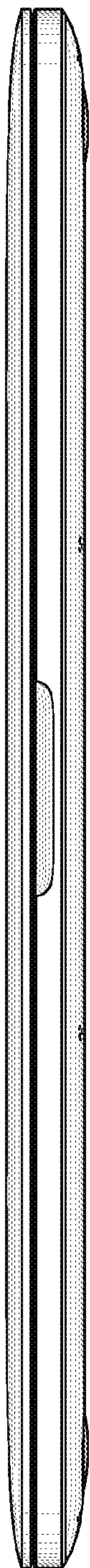

Fig. 19

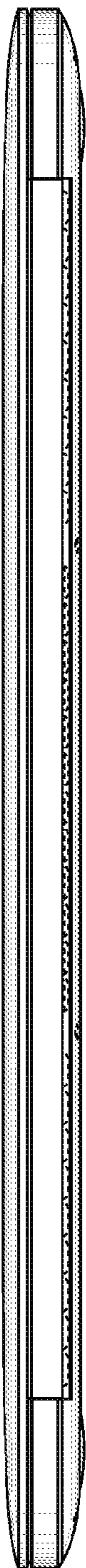

Fig. 20

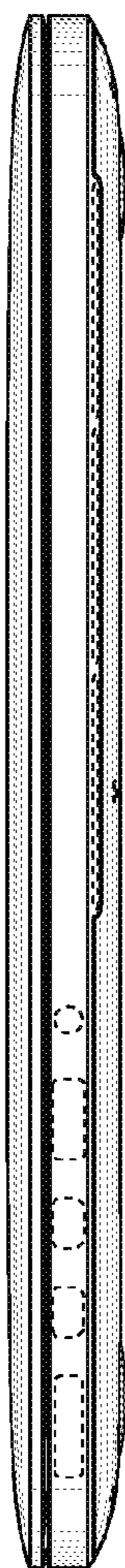

Fig. 21

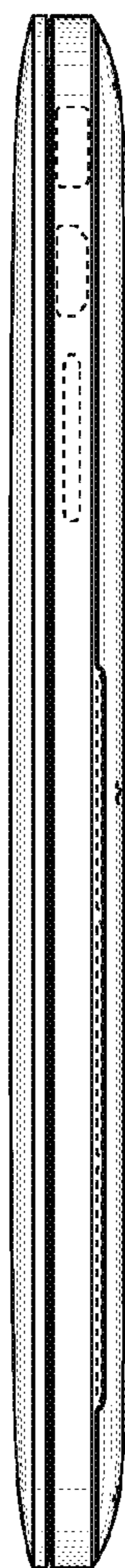

Fig. 22

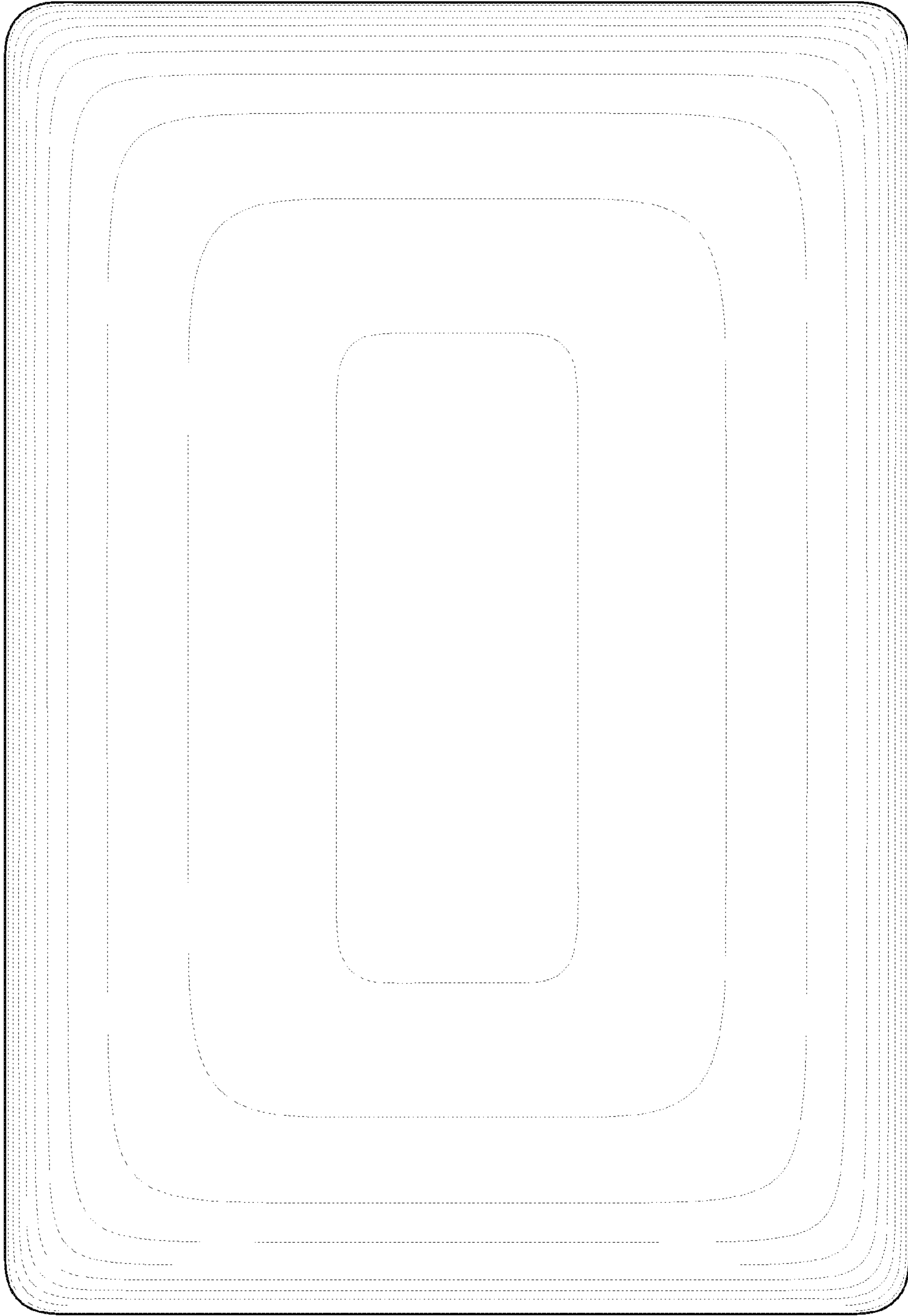

Fig. 23

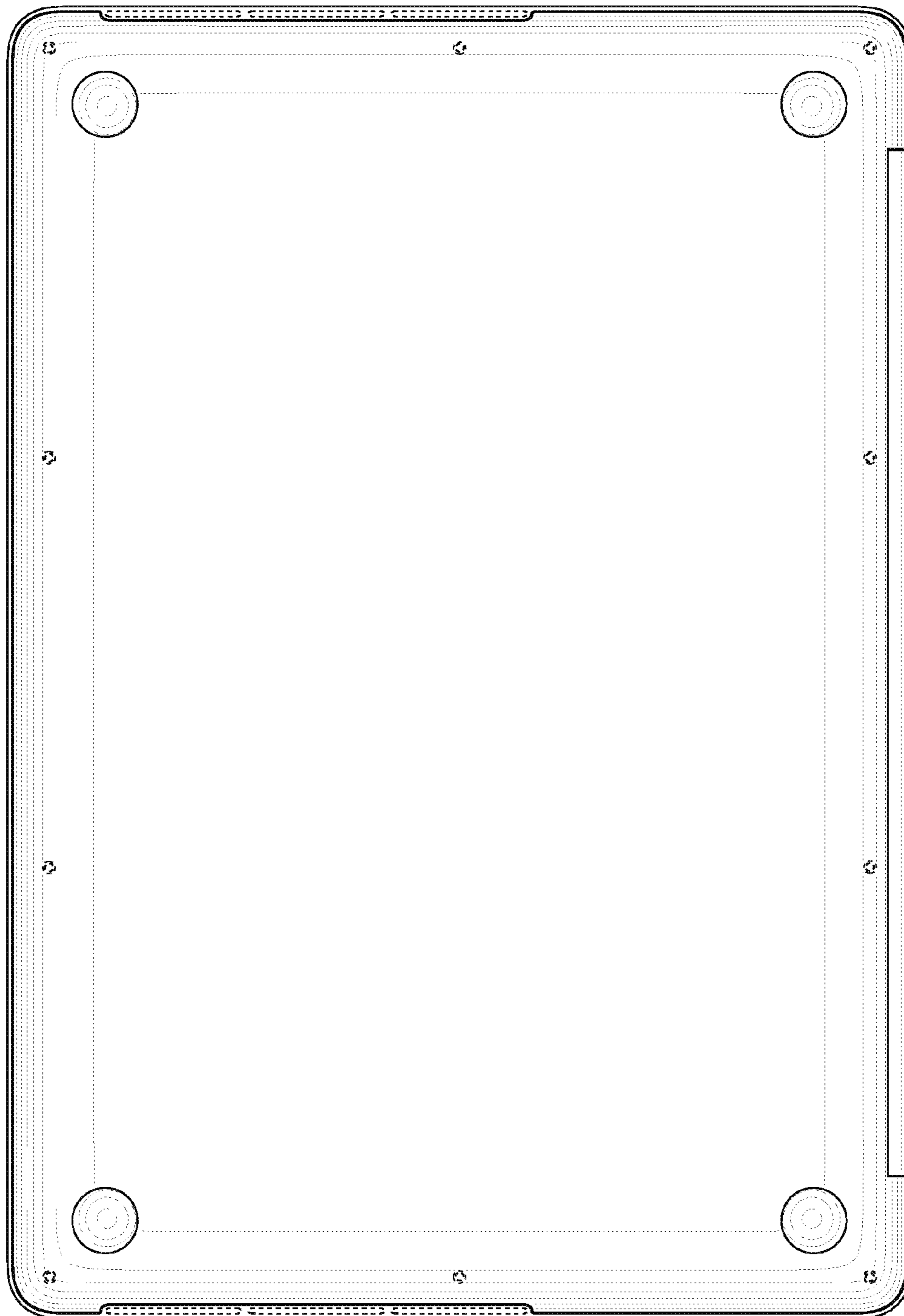

Fig. 24

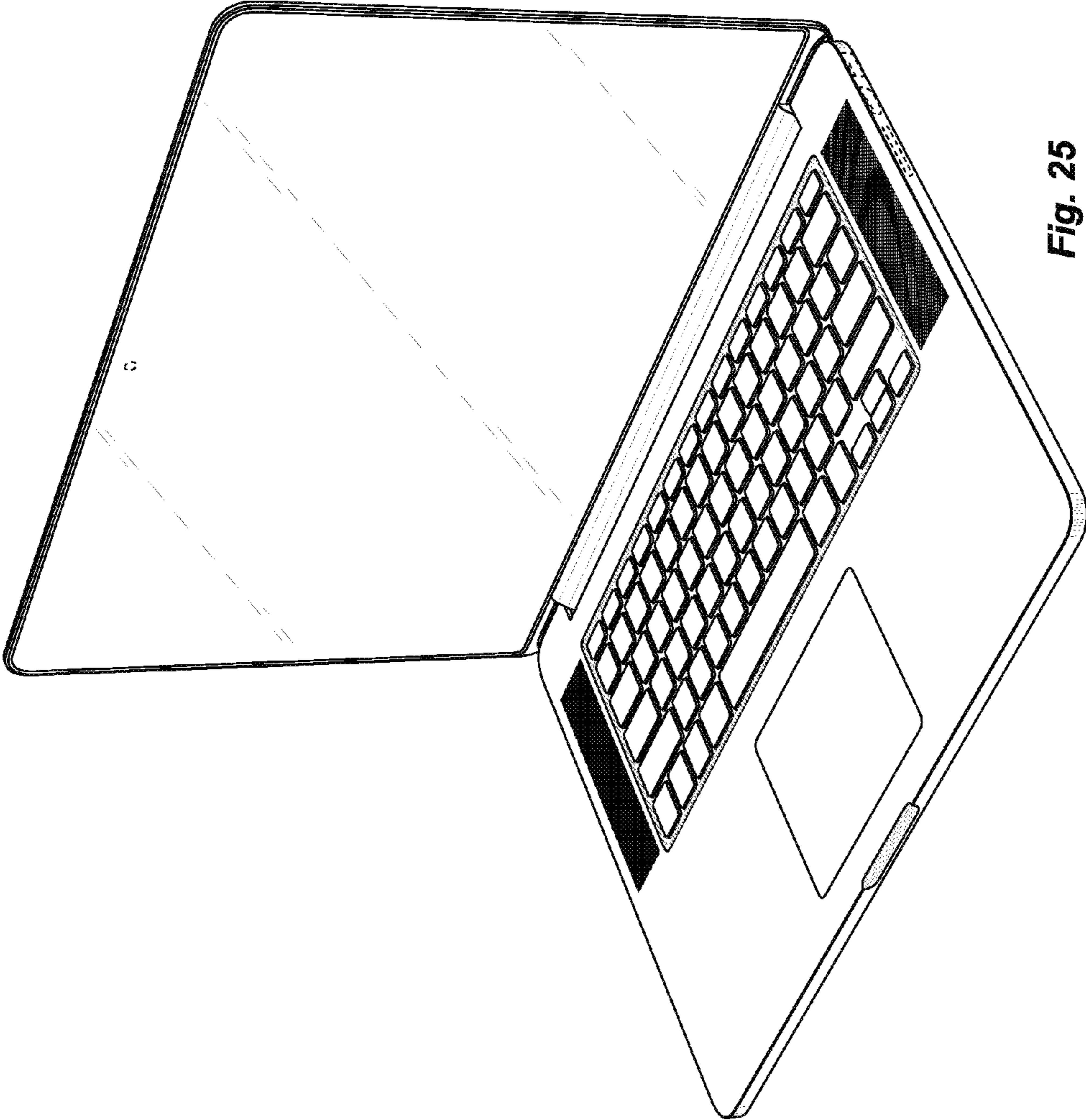

Fig. 25

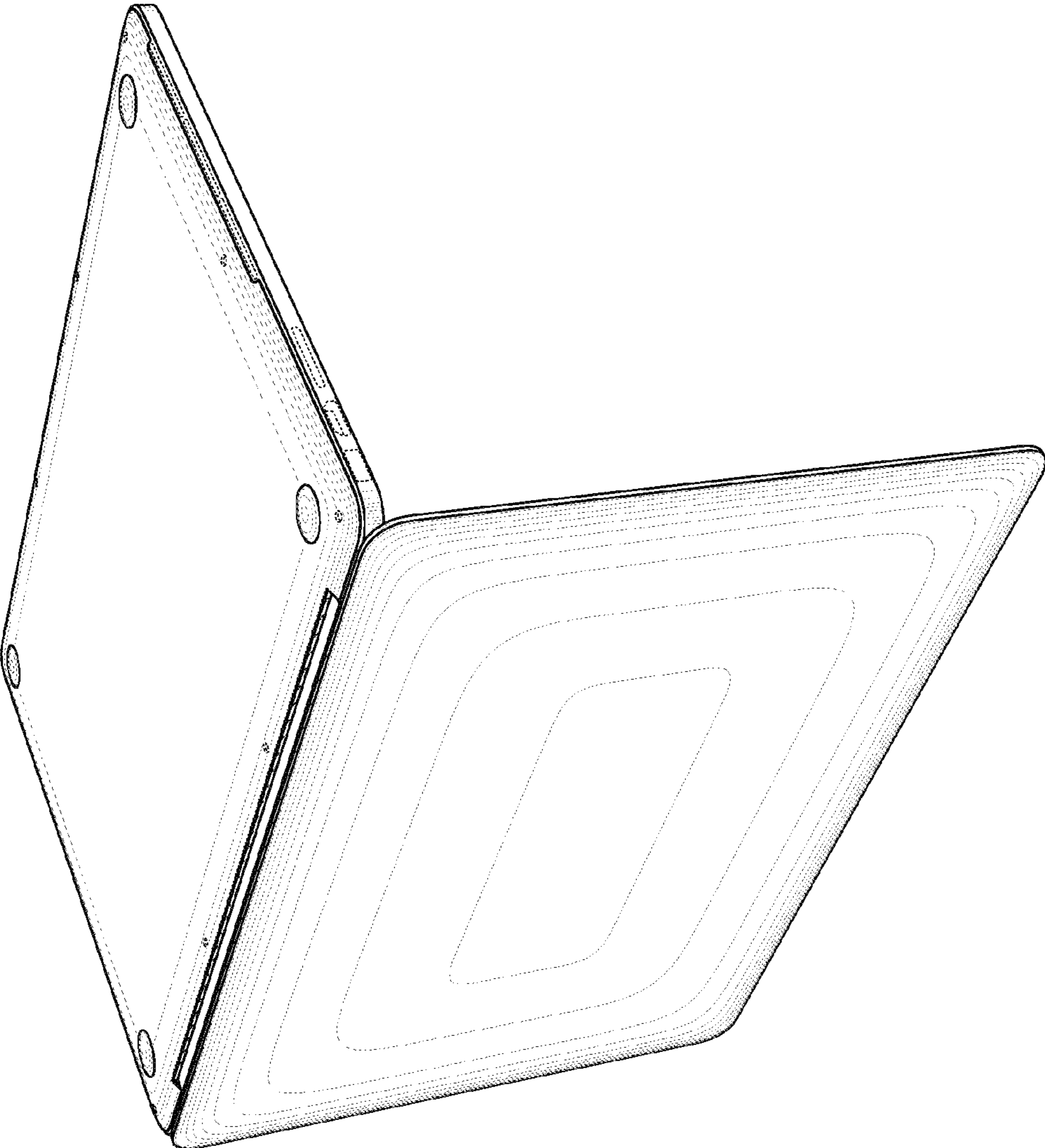

Fig. 26

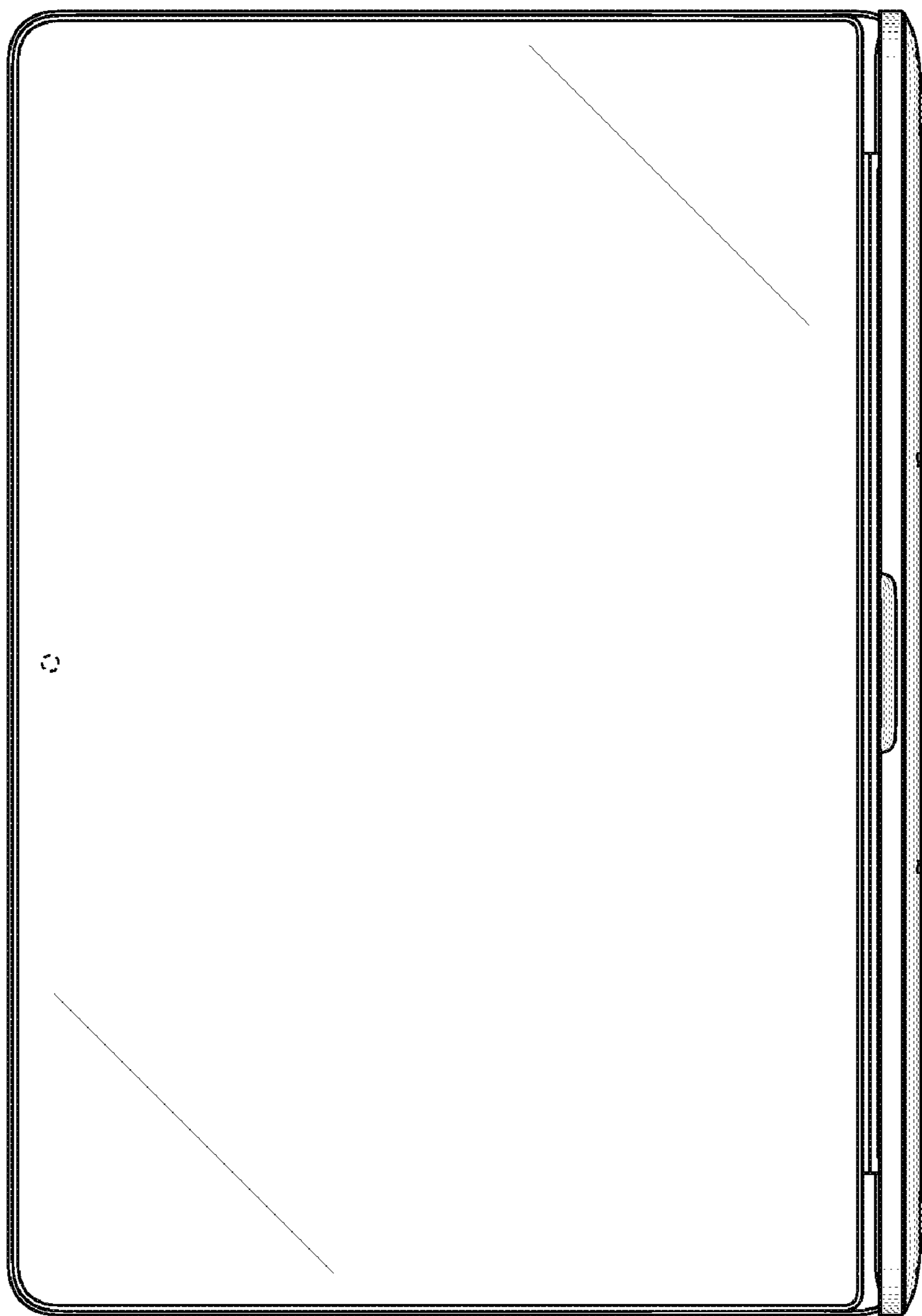

Fig. 27

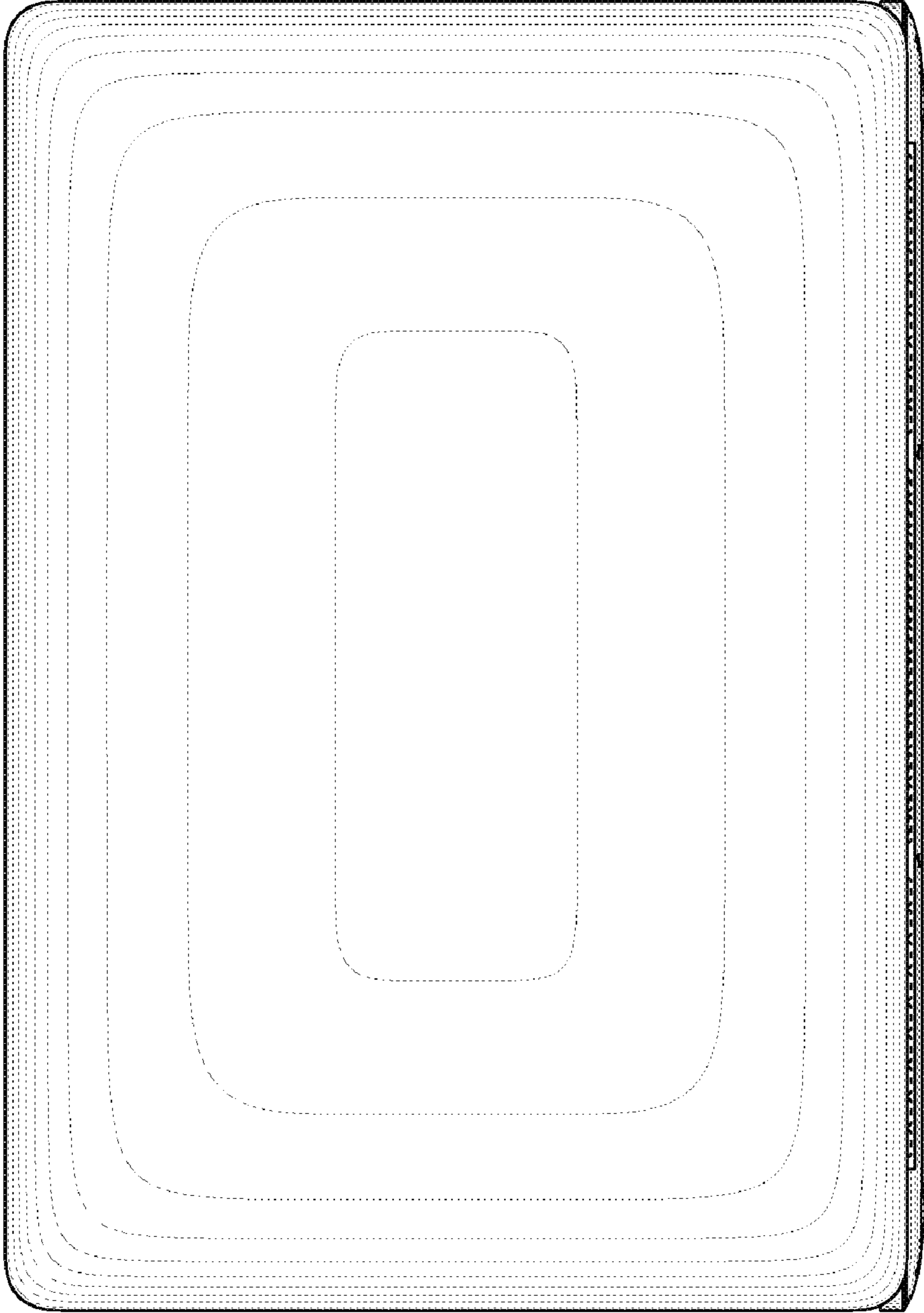

Fig. 28

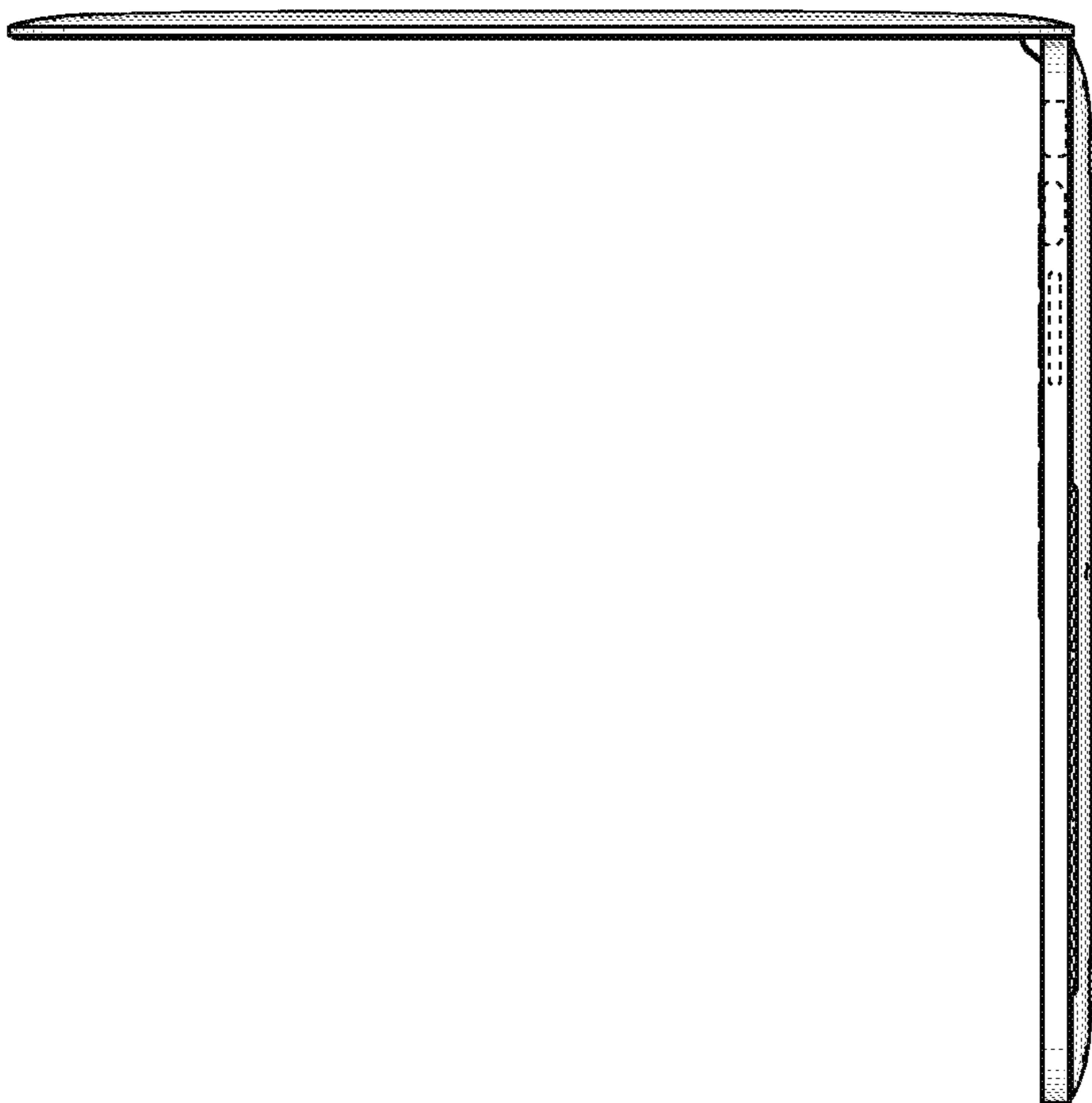

Fig. 30

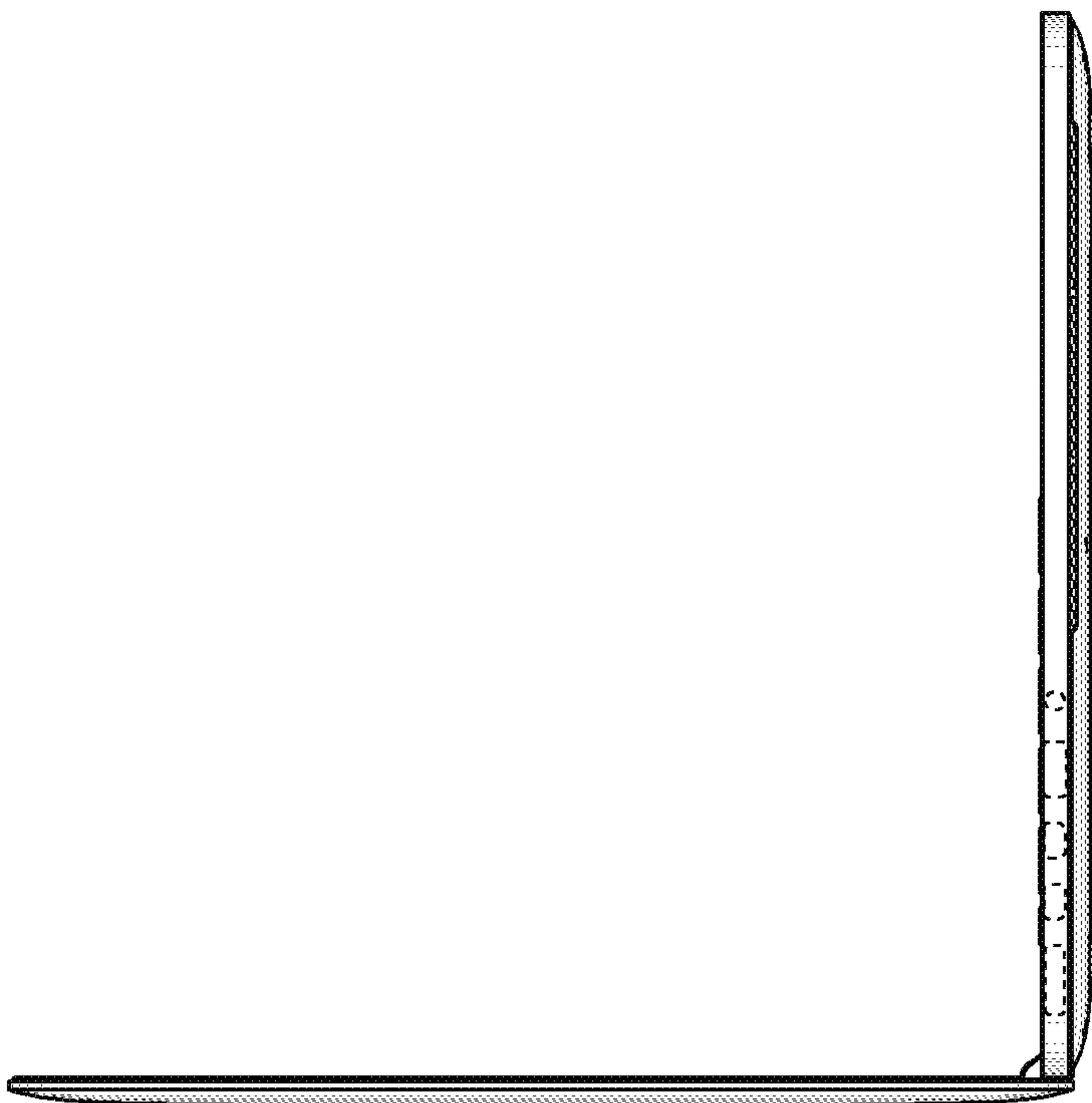

Fig. 29

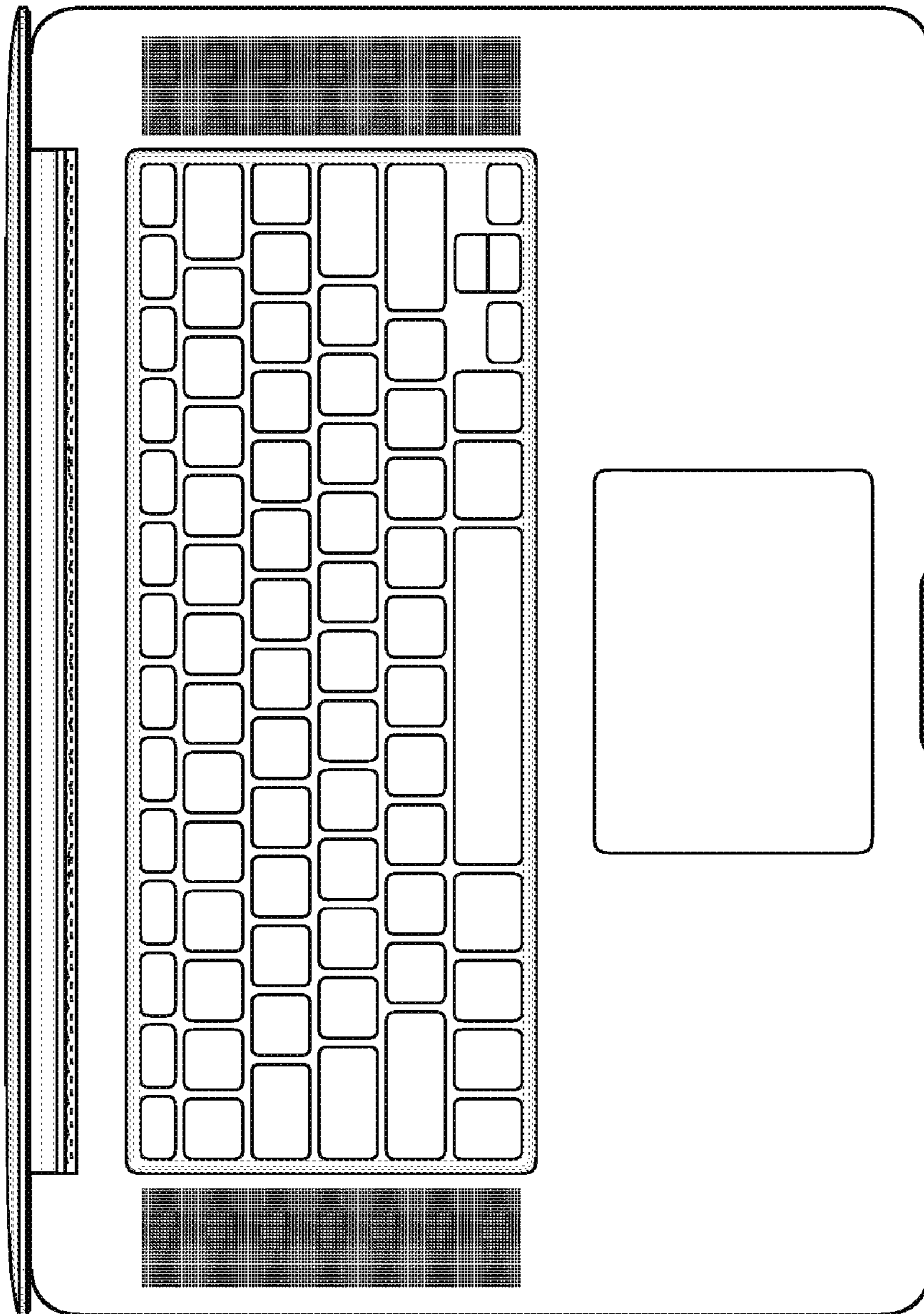

Fig. 31

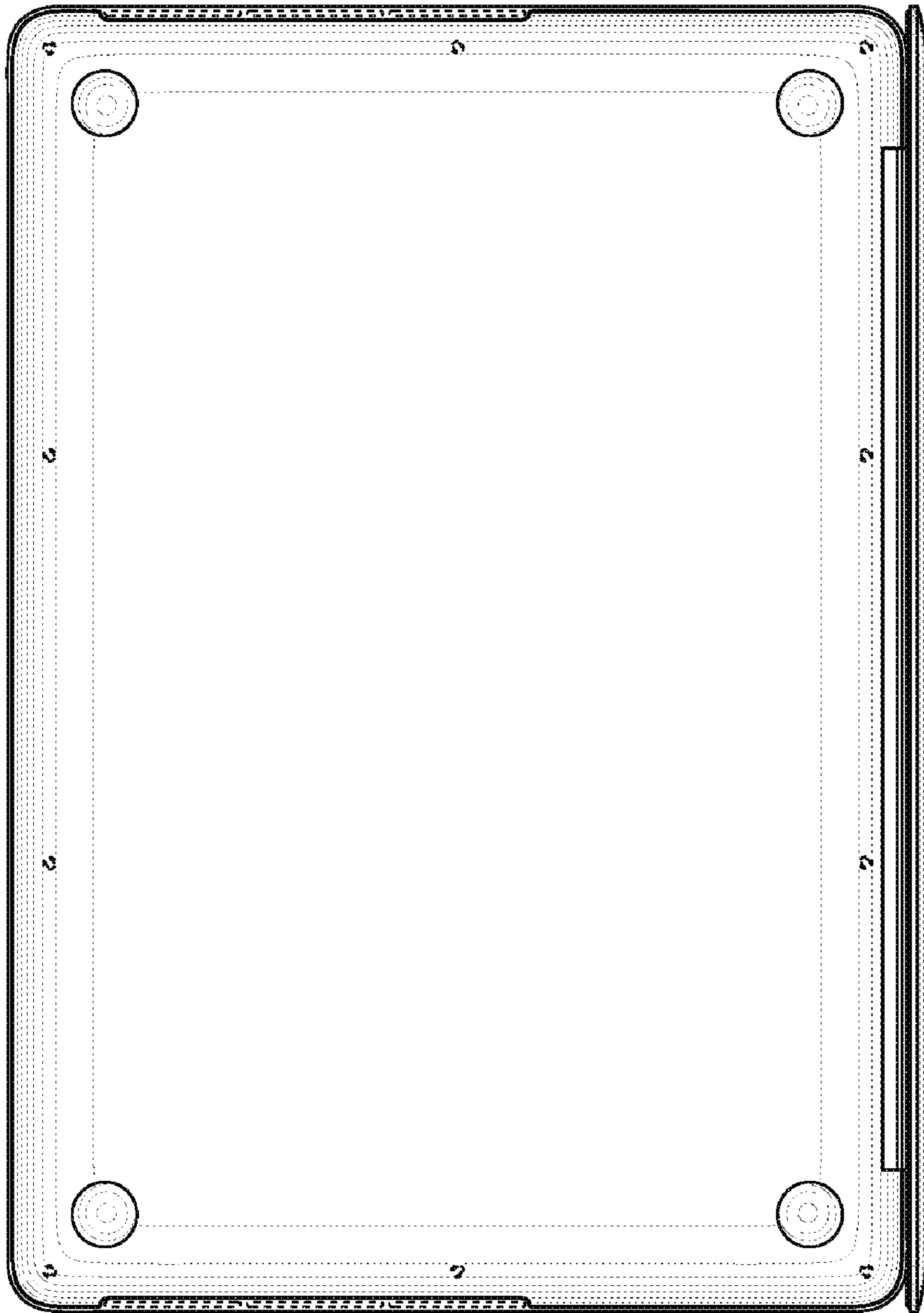

Fig. 32

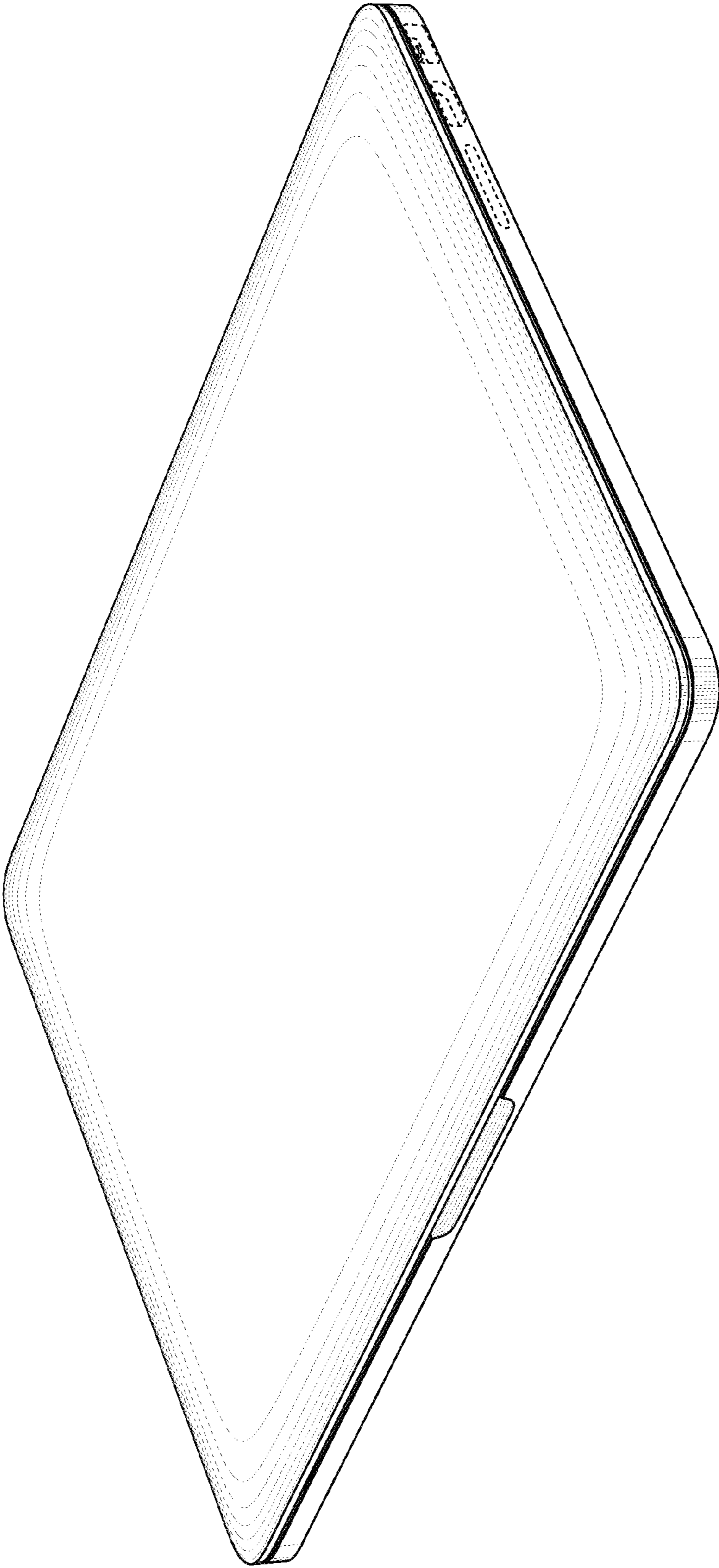

Fig. 33

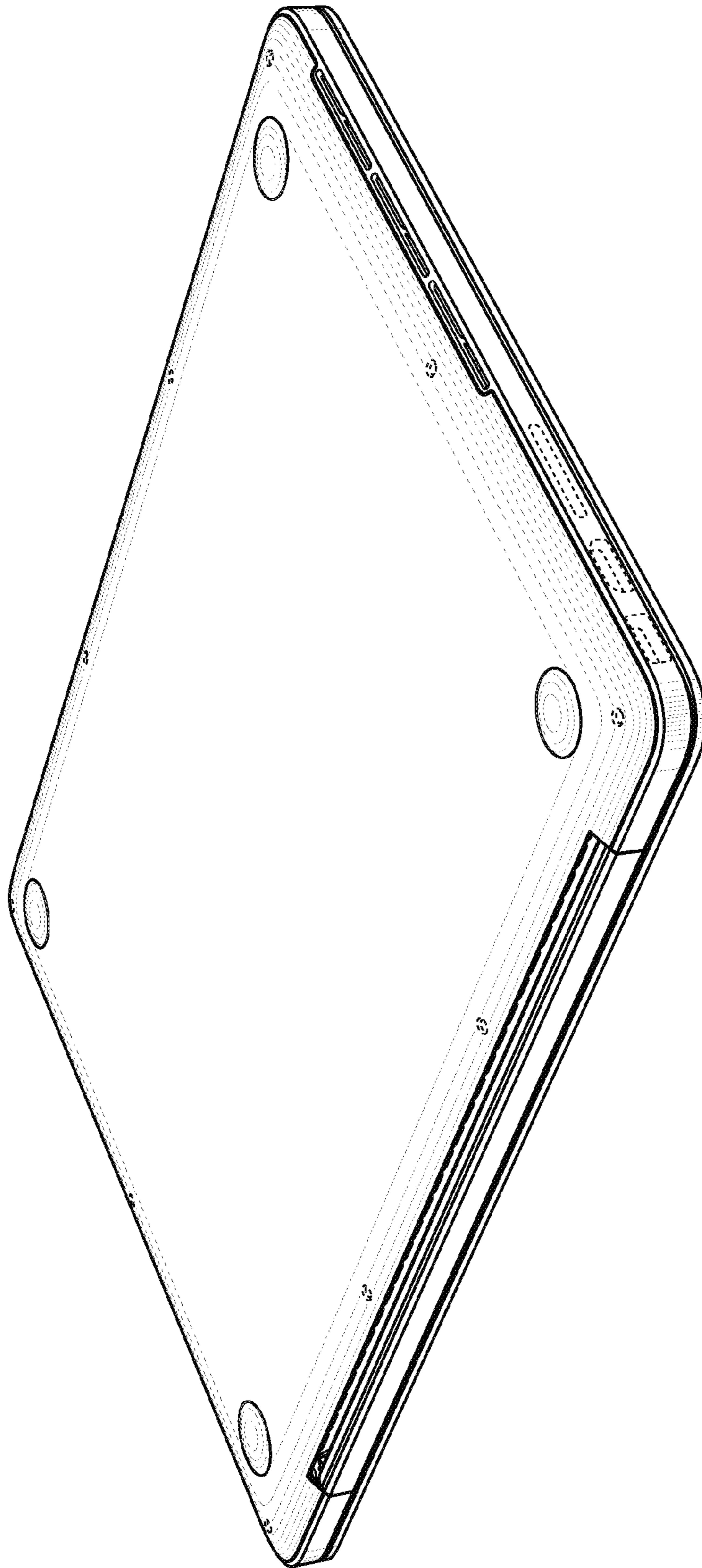

Fig. 34

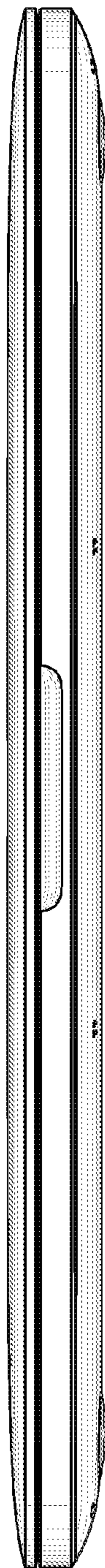

Fig. 35

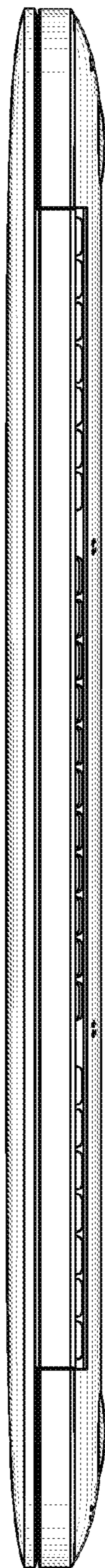

Fig. 36

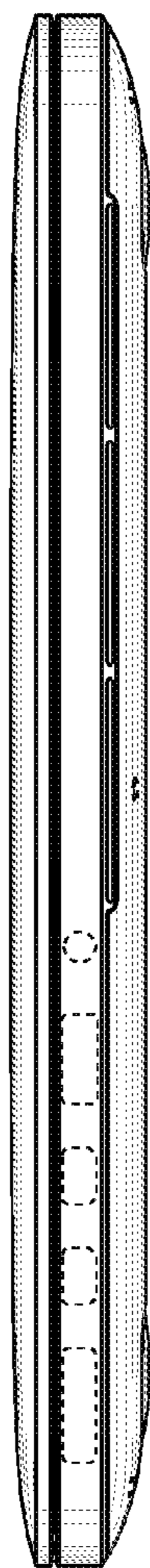

Fig. 37

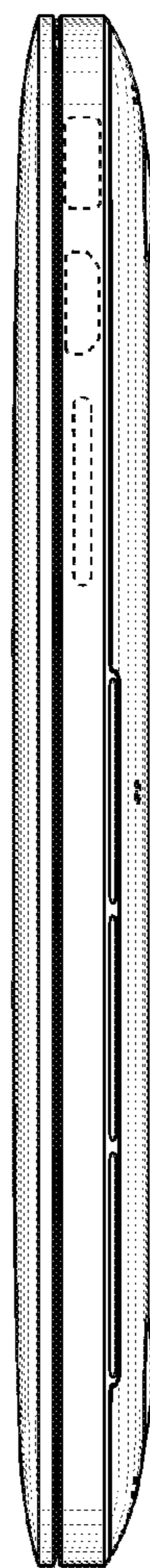

Fig. 38

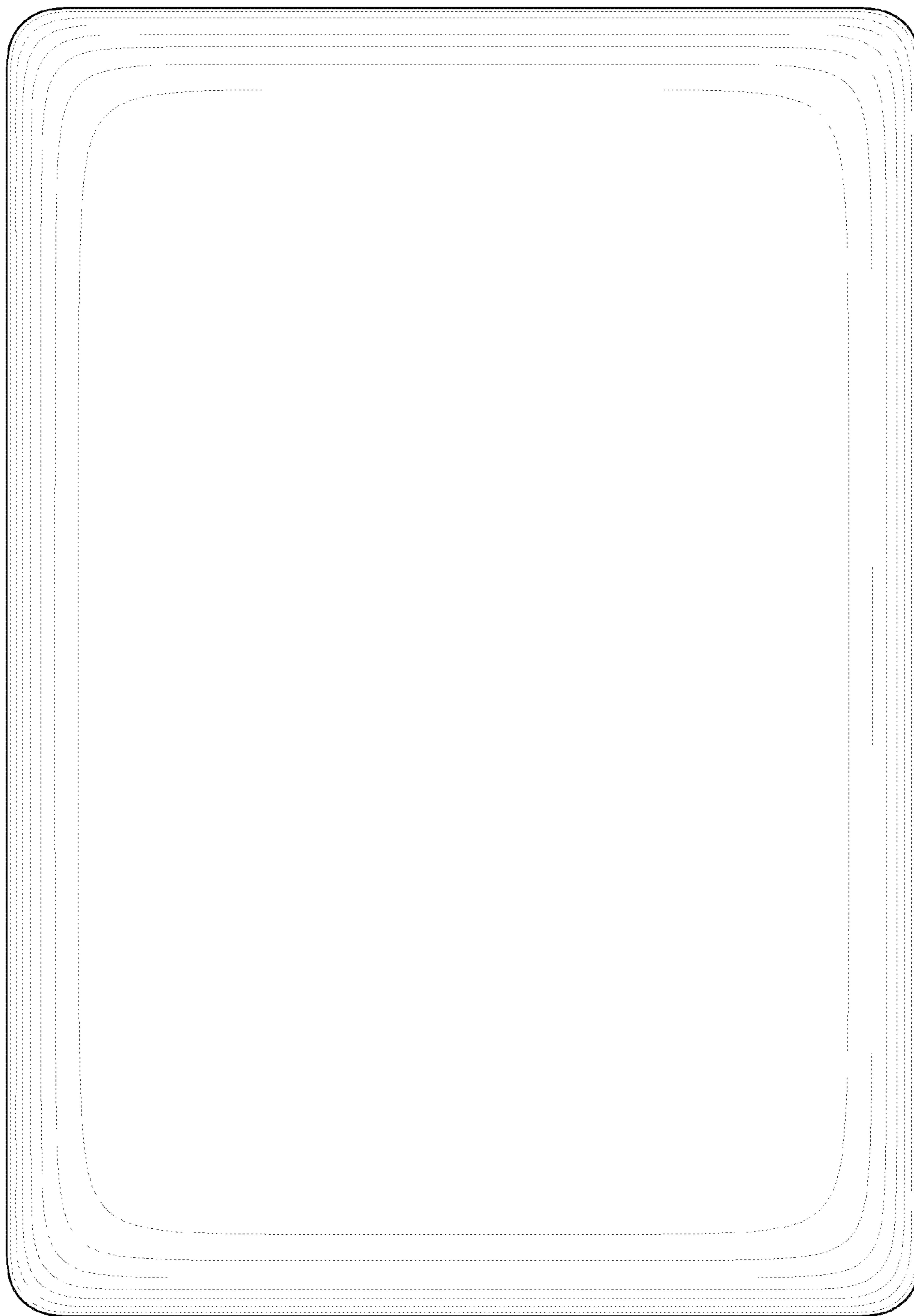

Fig. 39

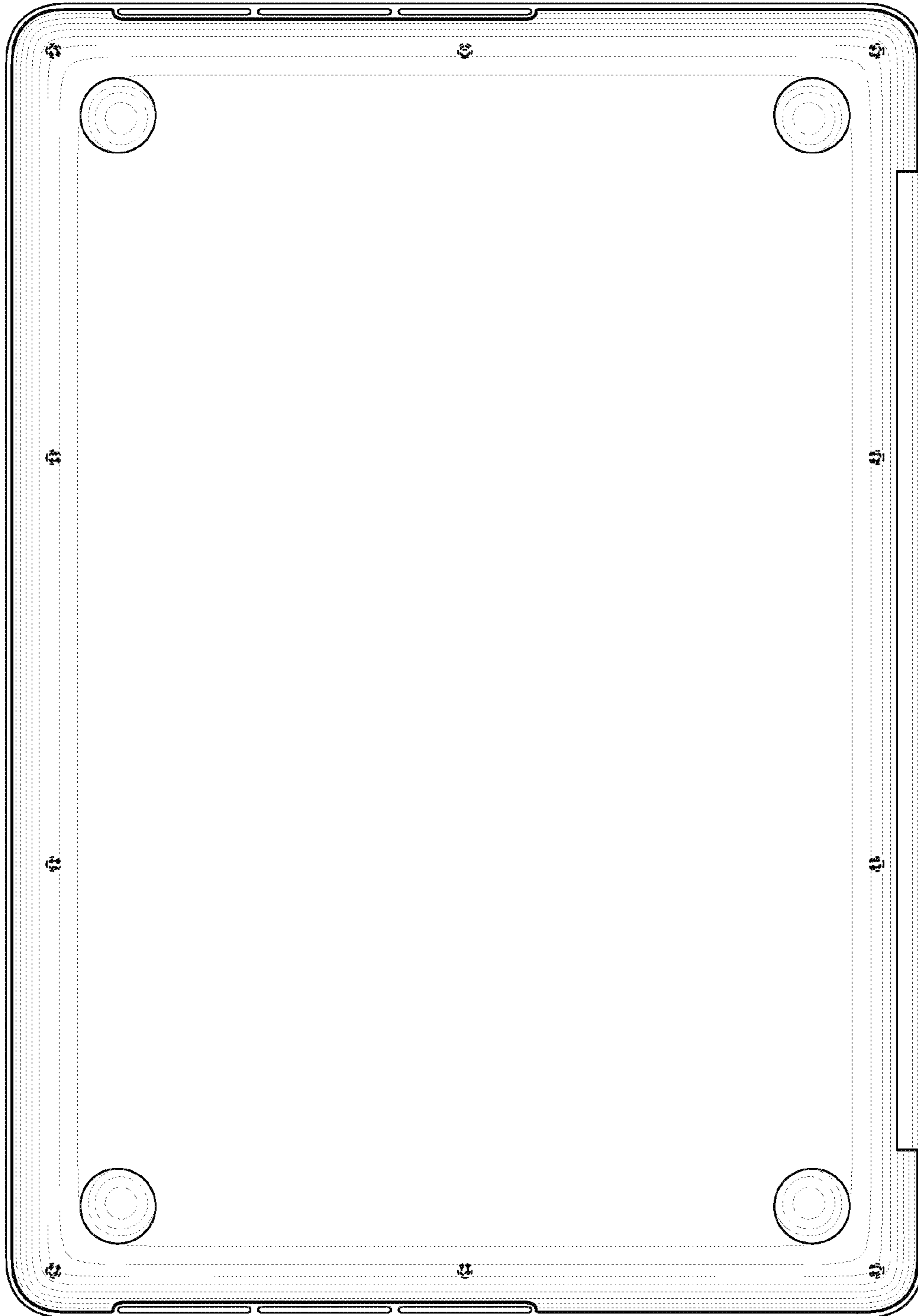

Fig. 40

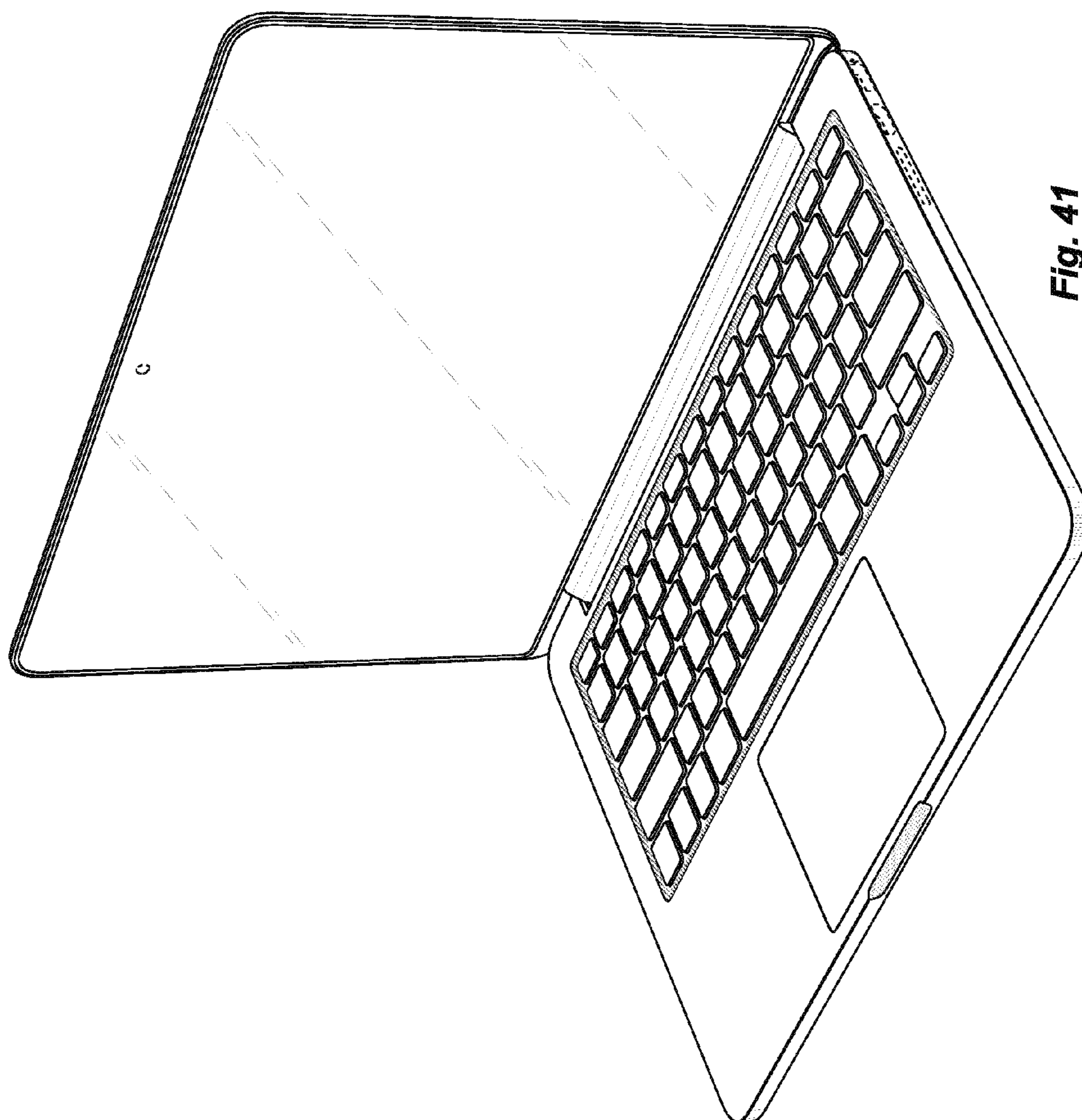

Fig. 41

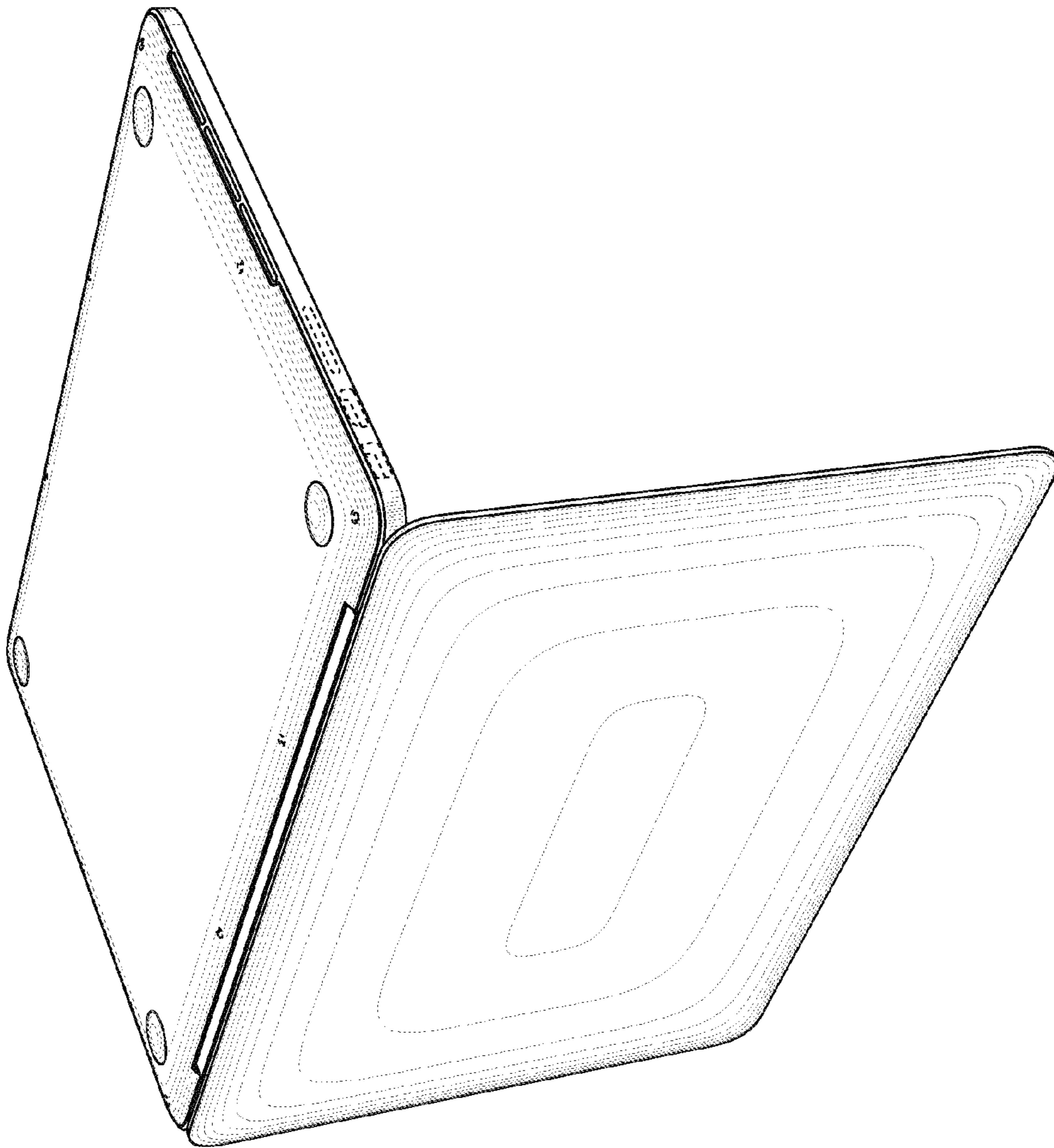

Fig. 42

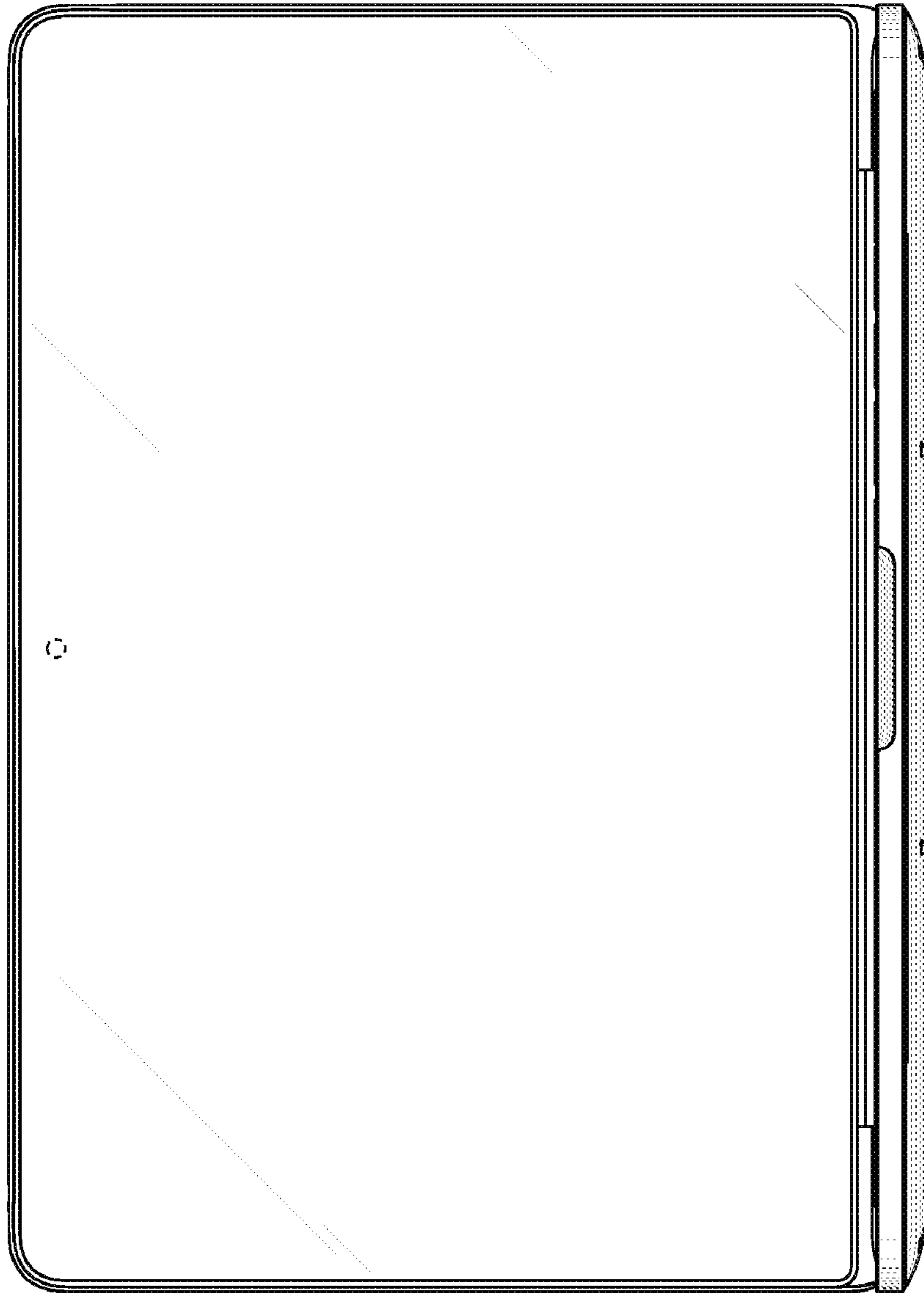

Fig. 43

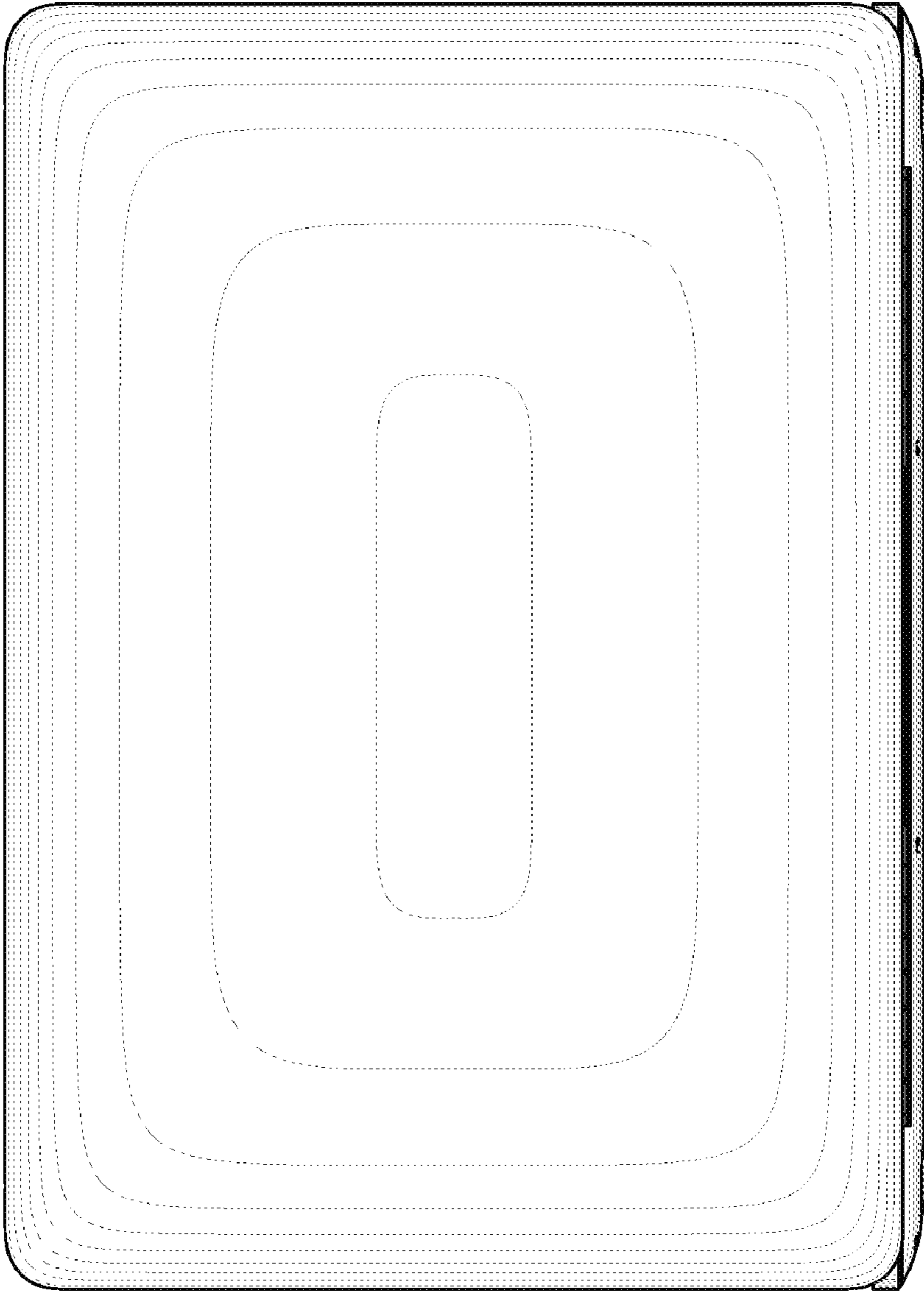

Fig. 44

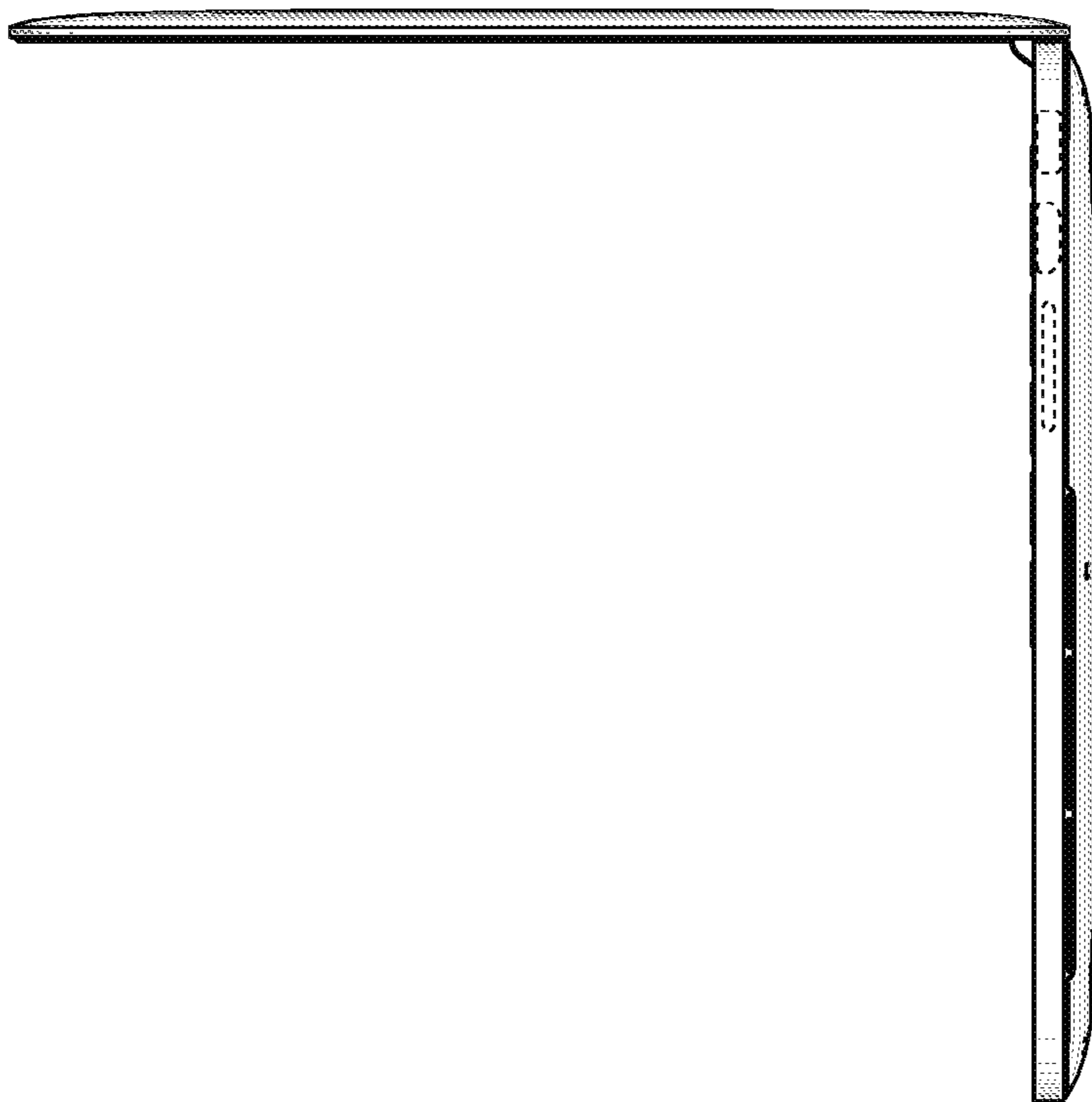

Fig. 46

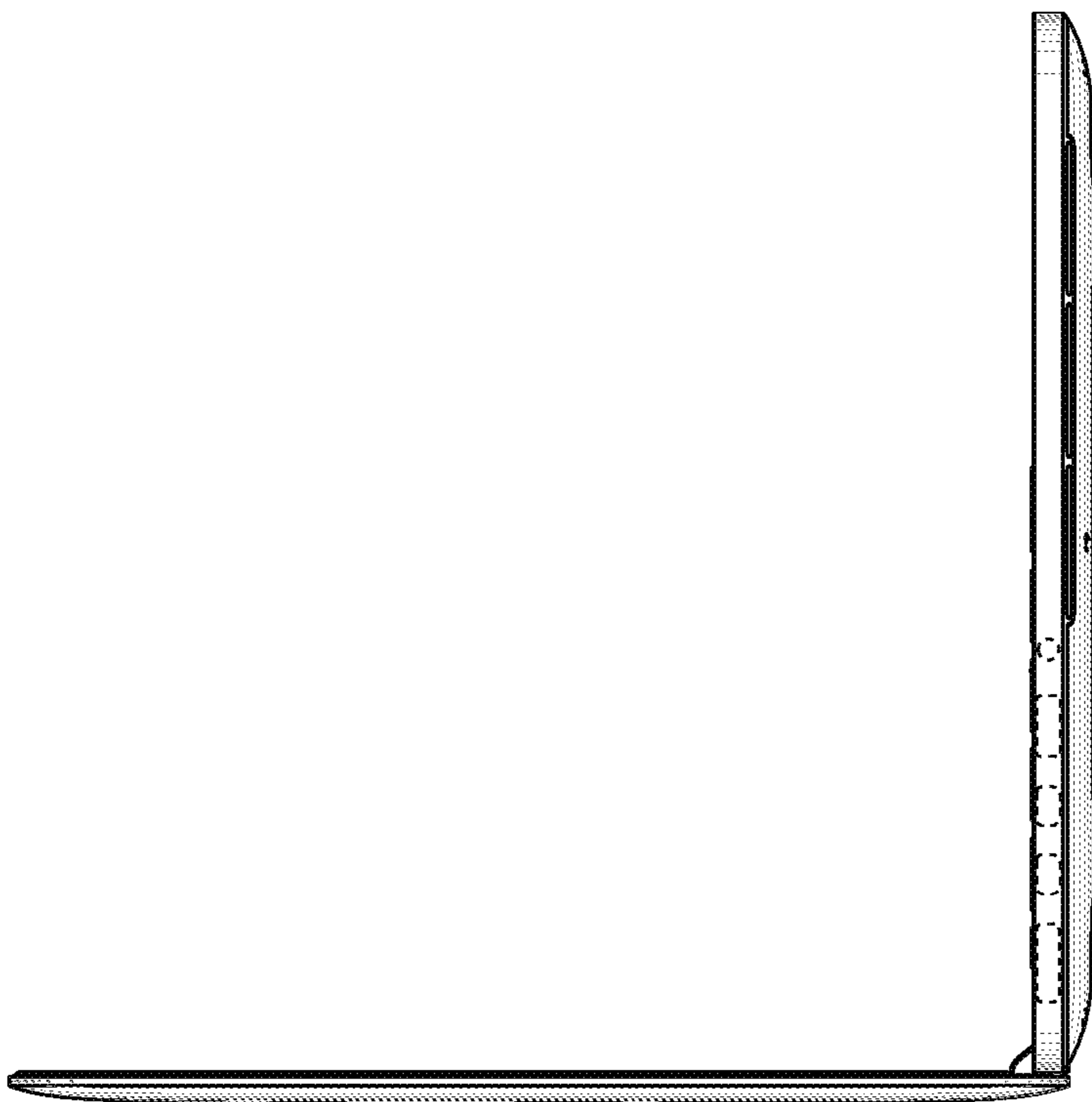

Fig. 45

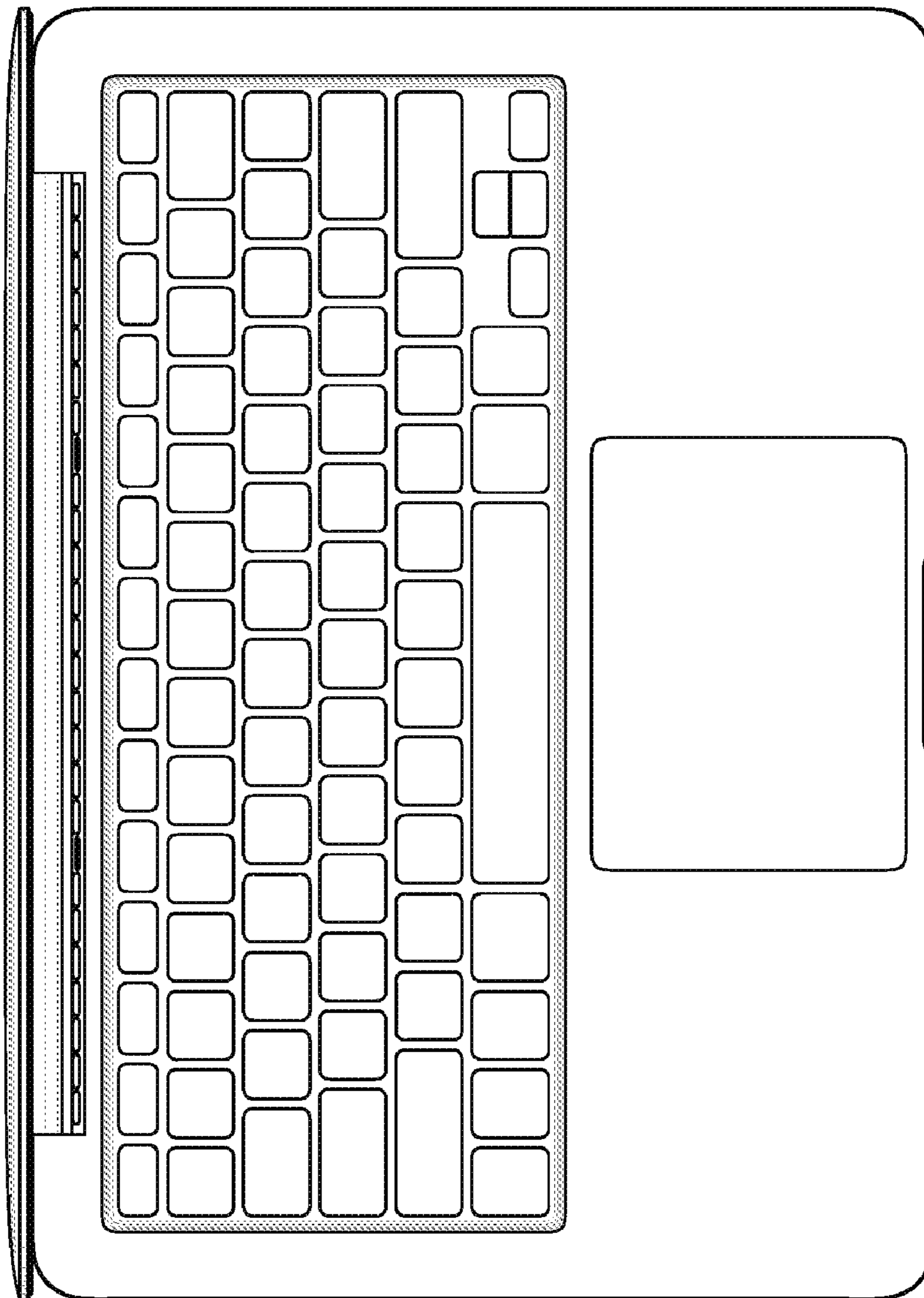

Fig. 47

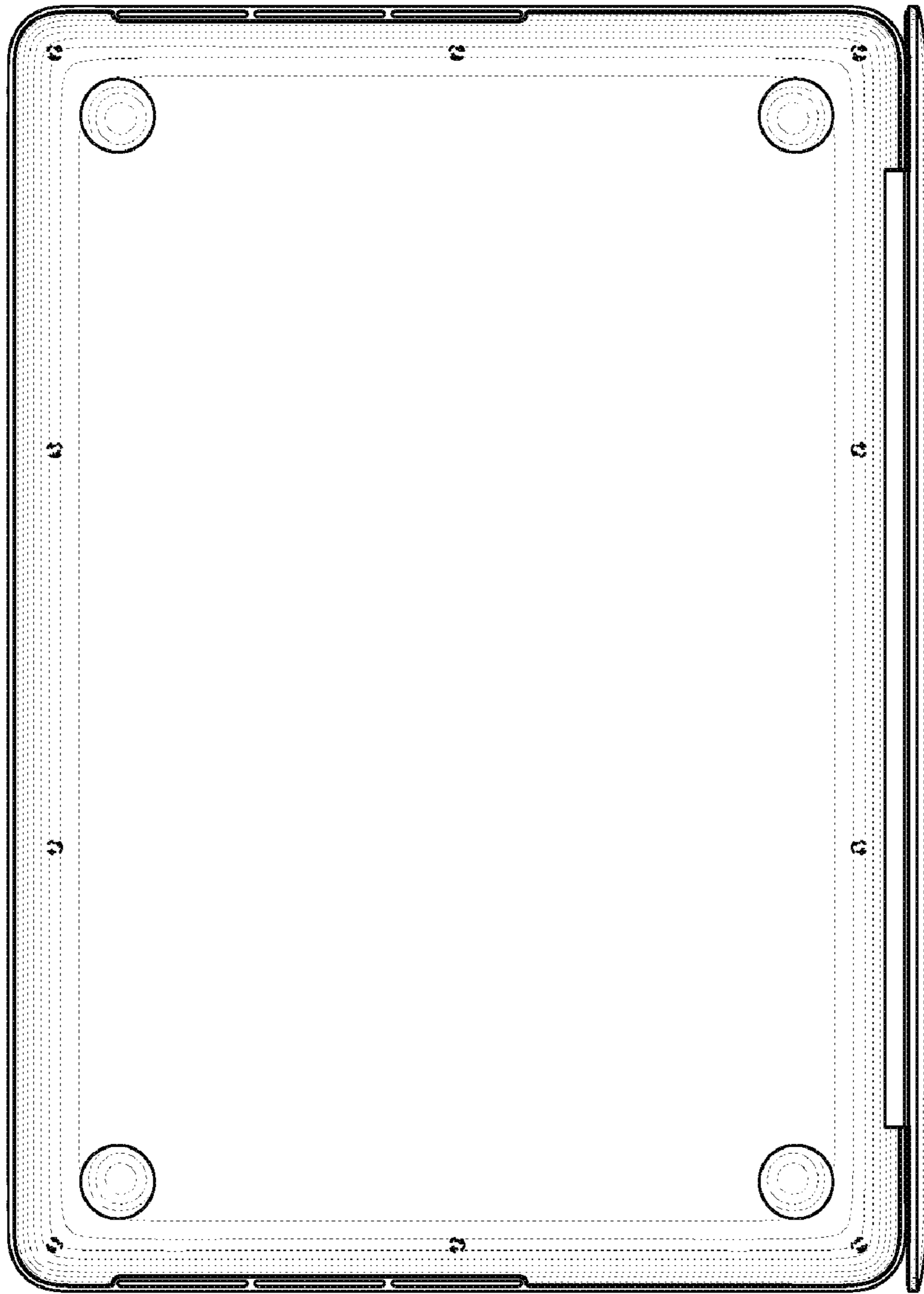

Fig. 48

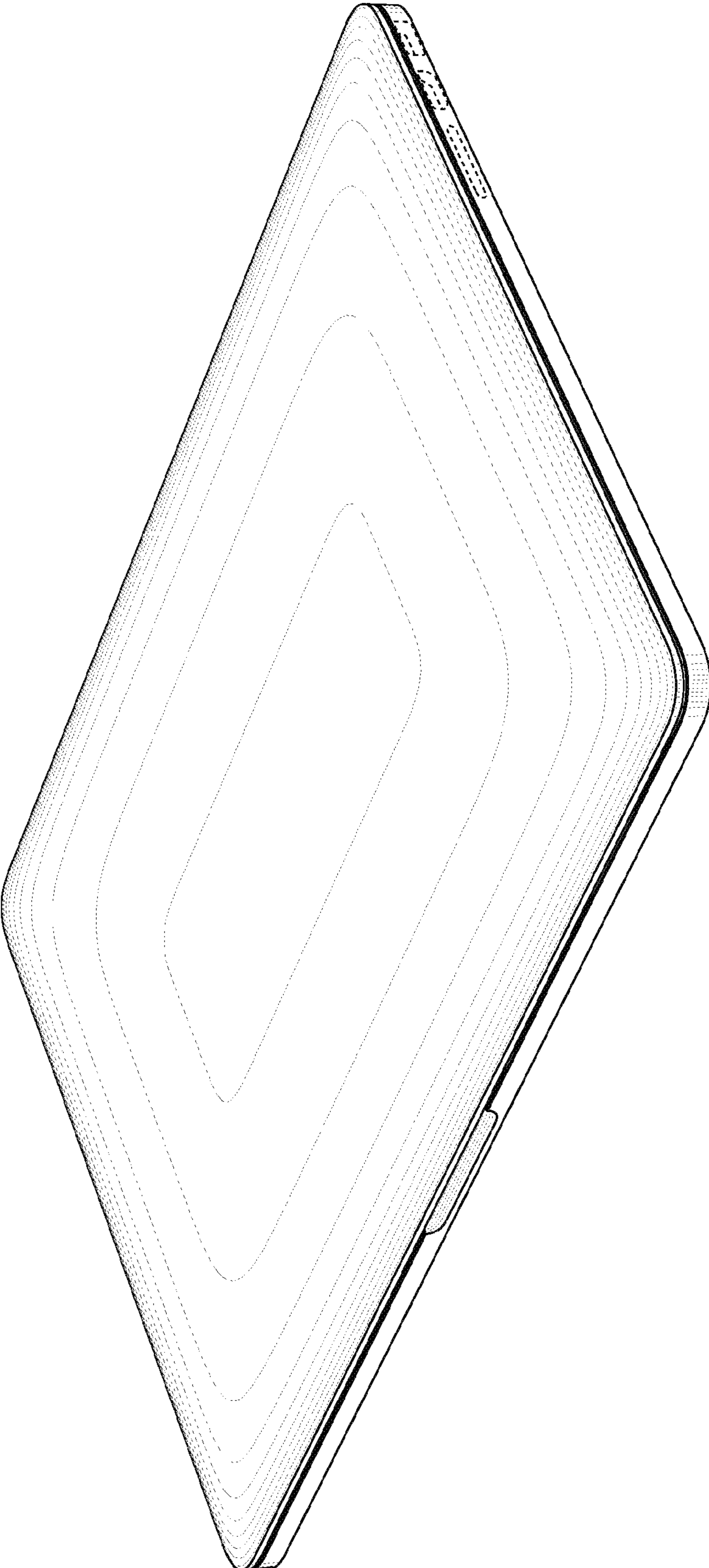

Fig. 49

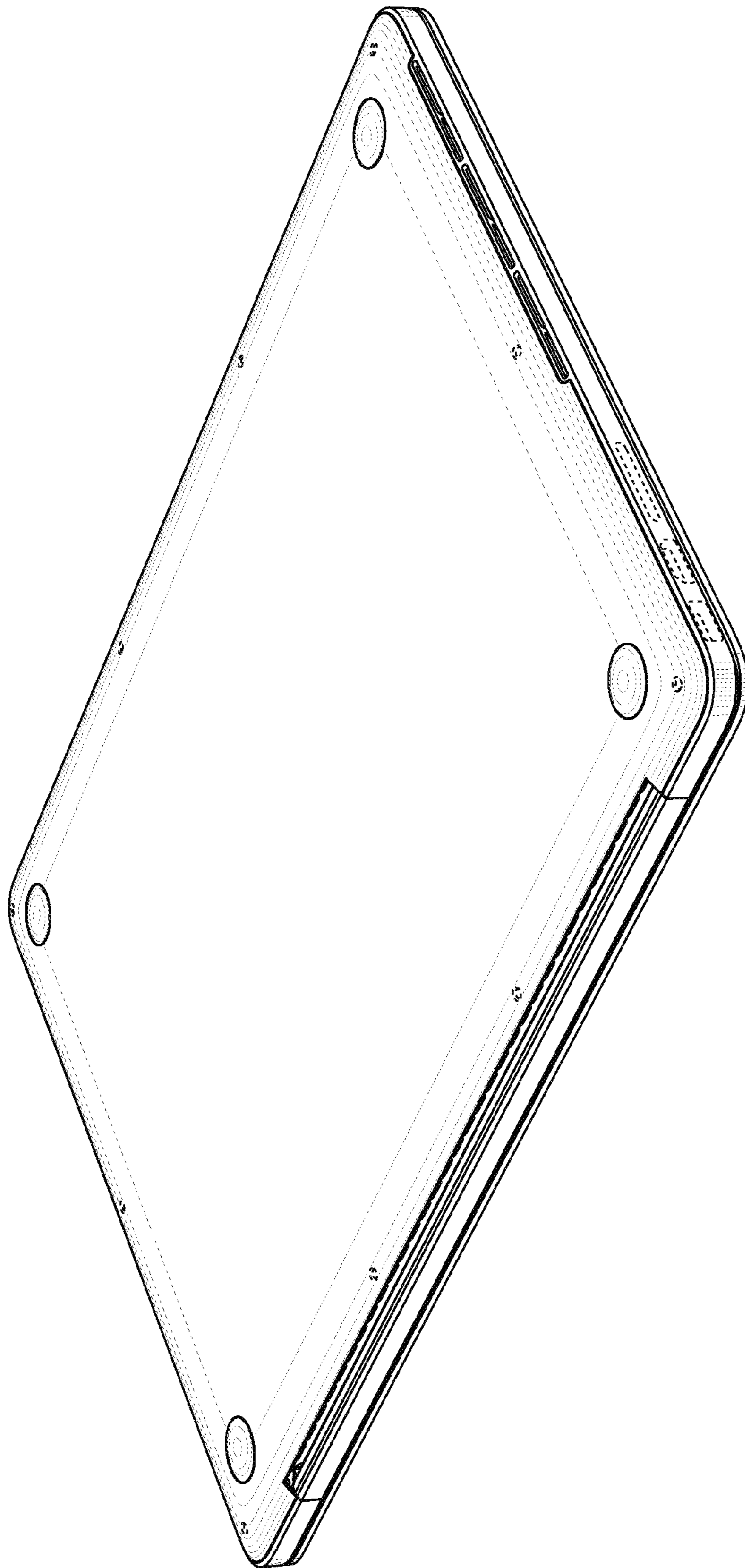

Fig. 50

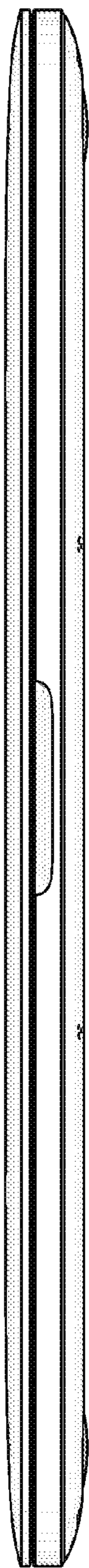

Fig. 51

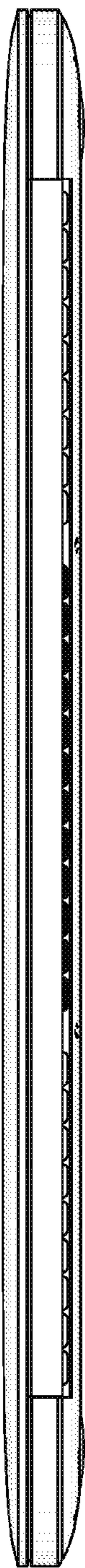

Fig. 52

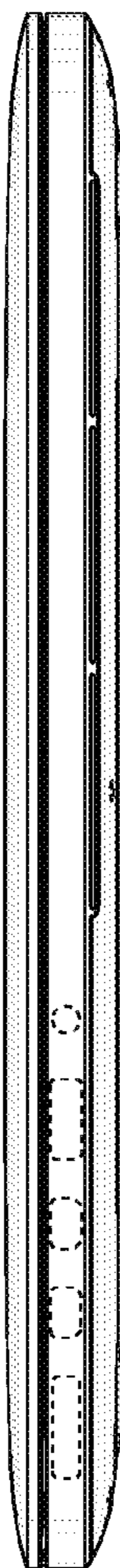

Fig. 53

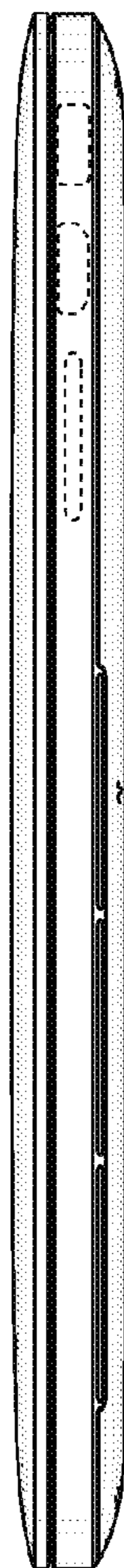

Fig. 54

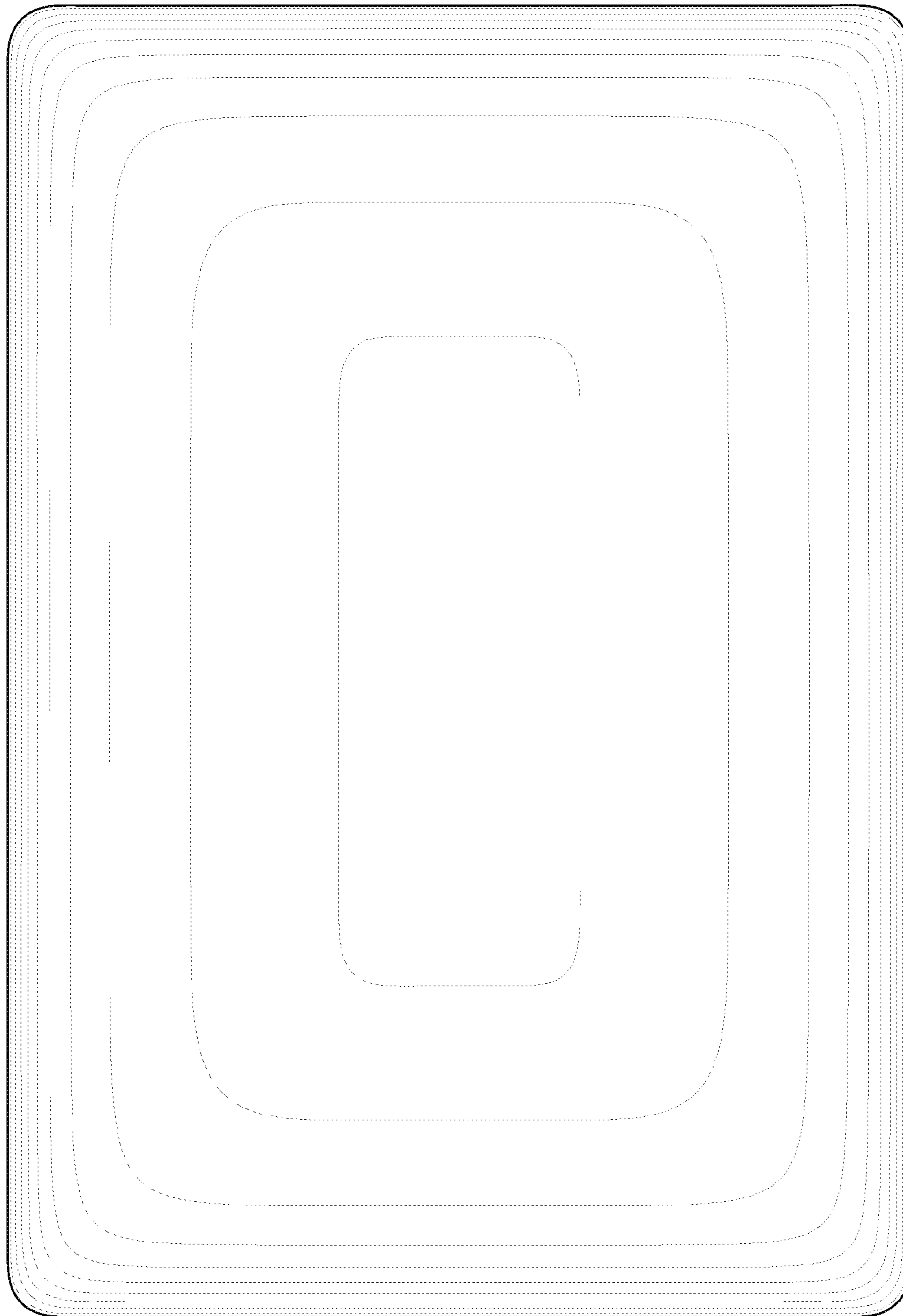

Fig. 55

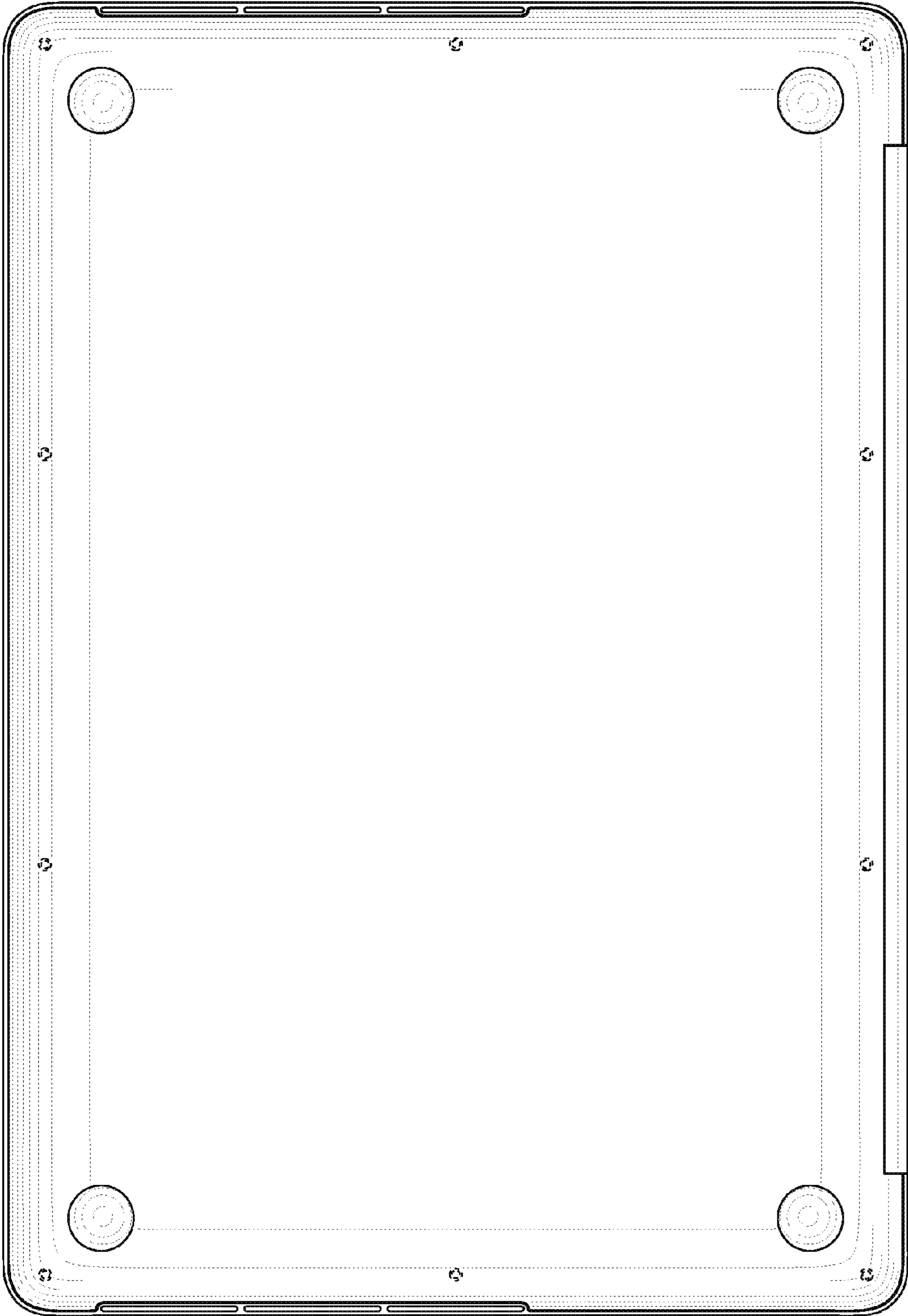

Fig. 56

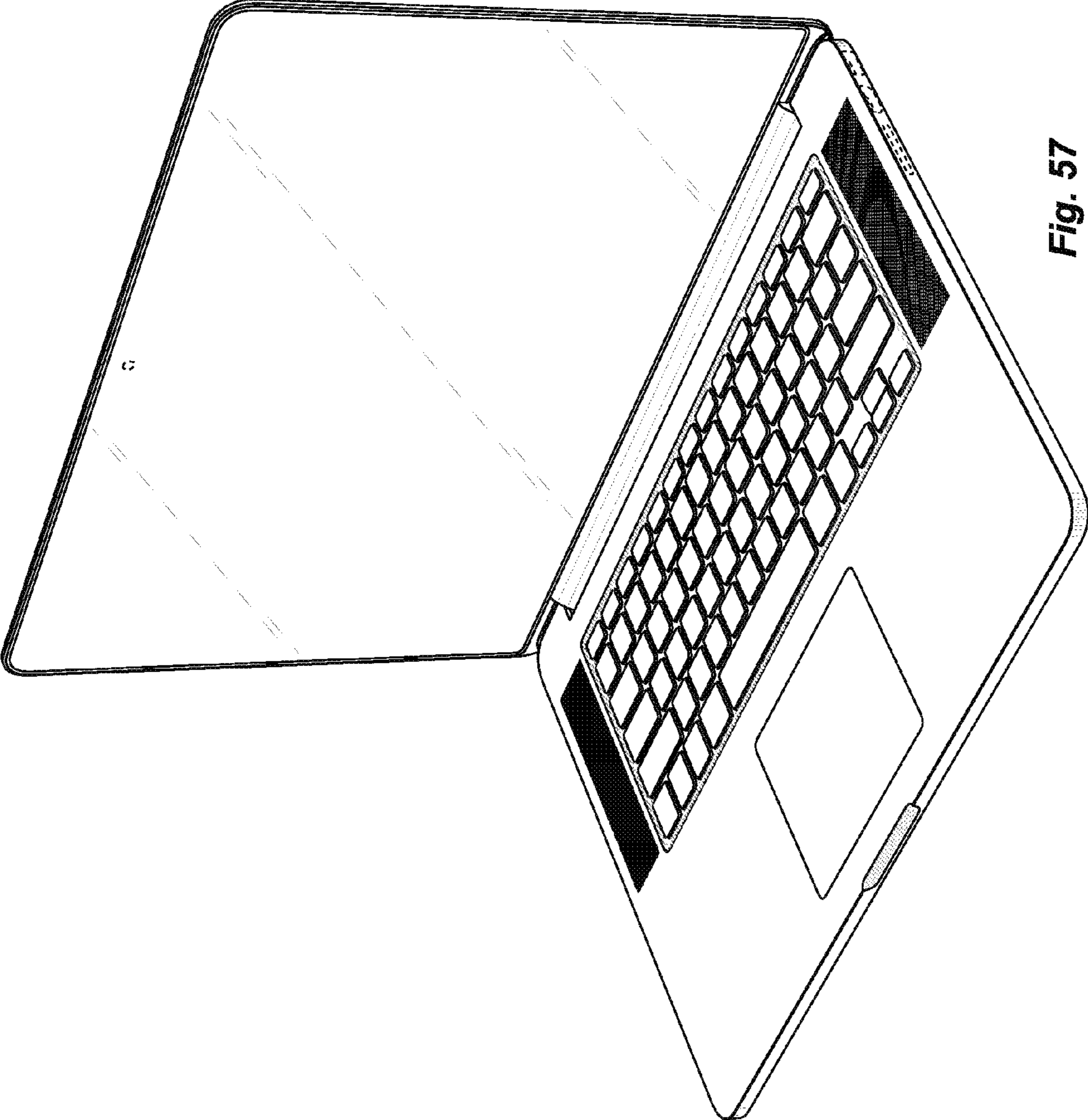

Fig. 57

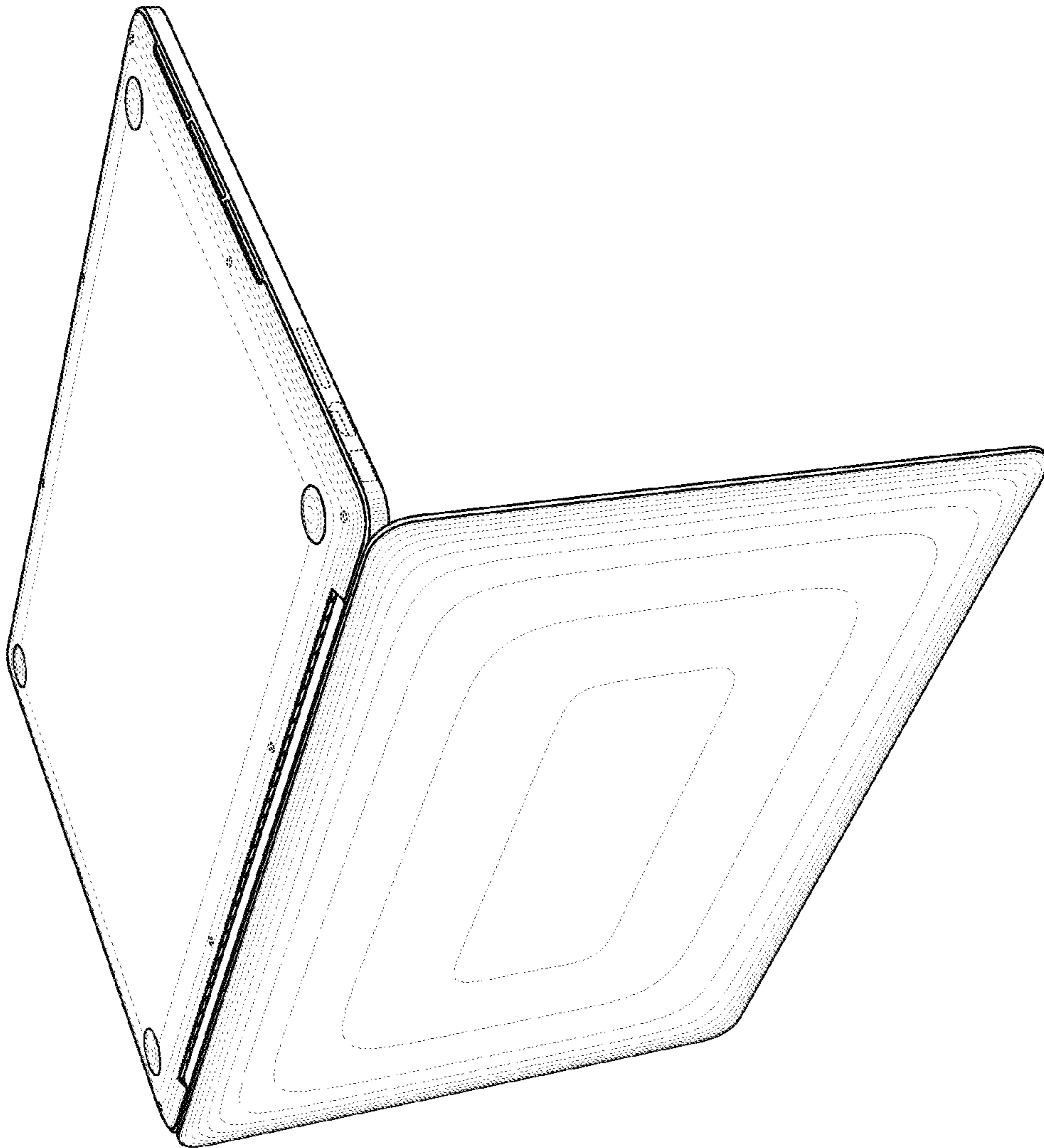

Fig. 58

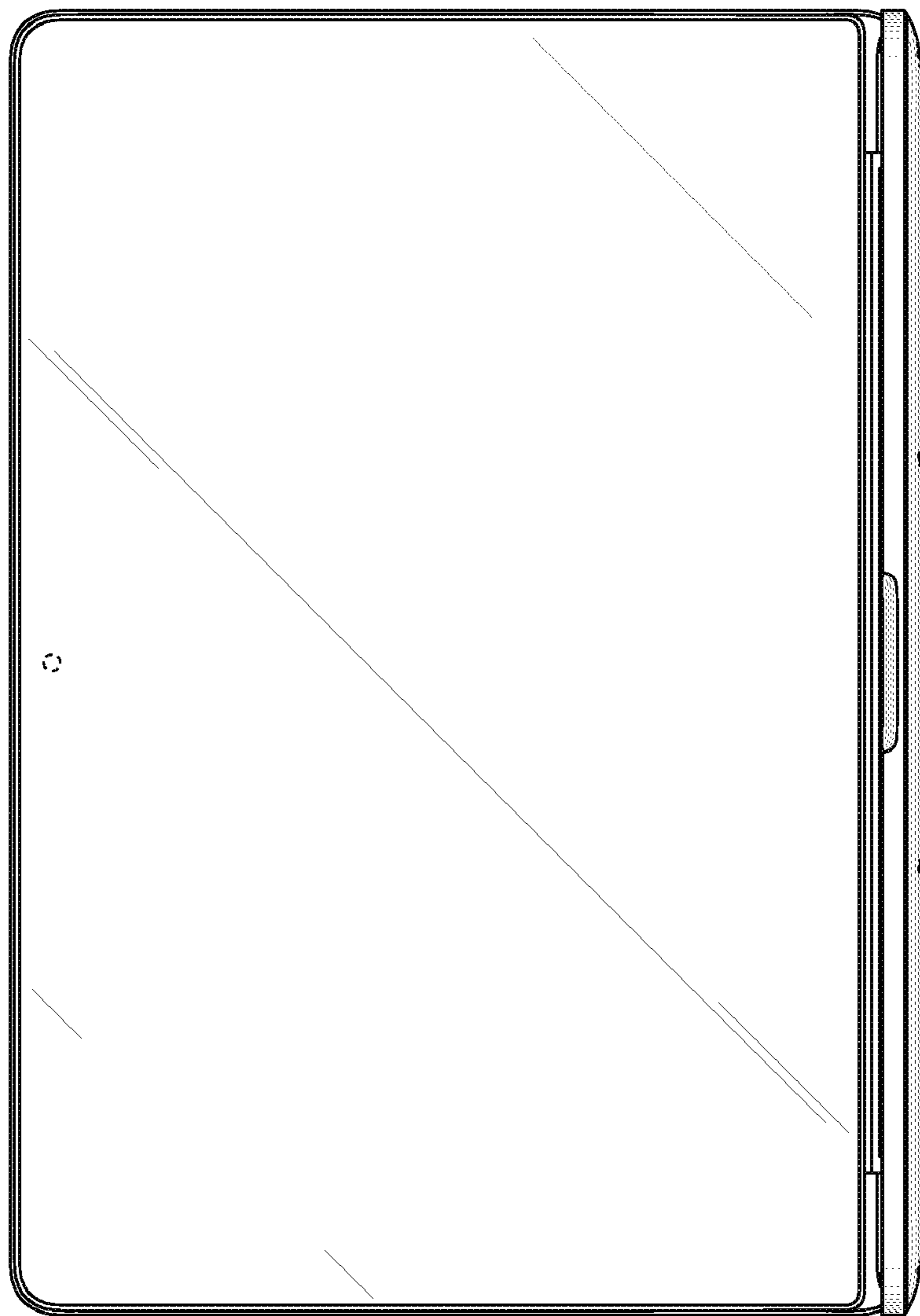

Fig. 59

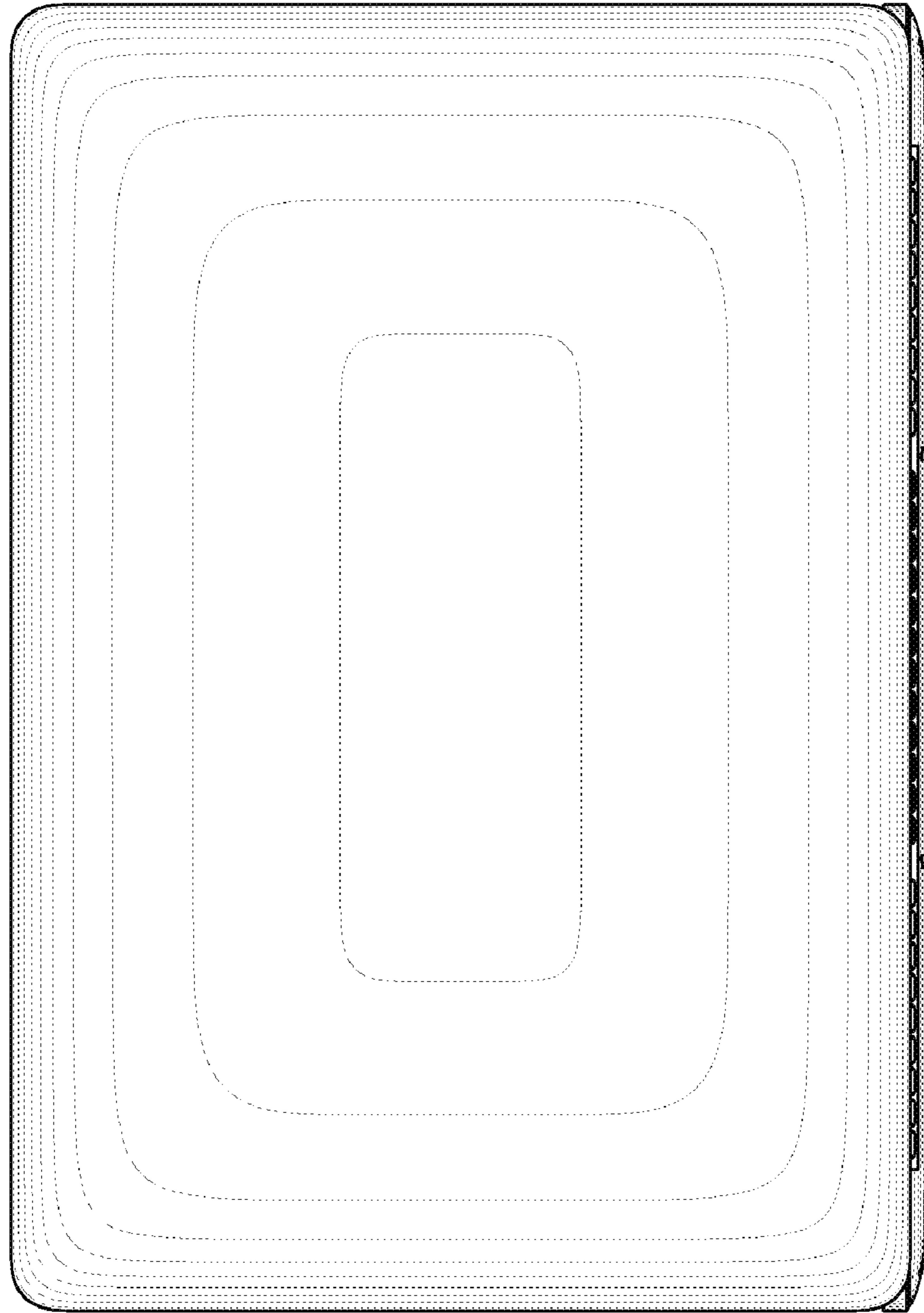

Fig. 60

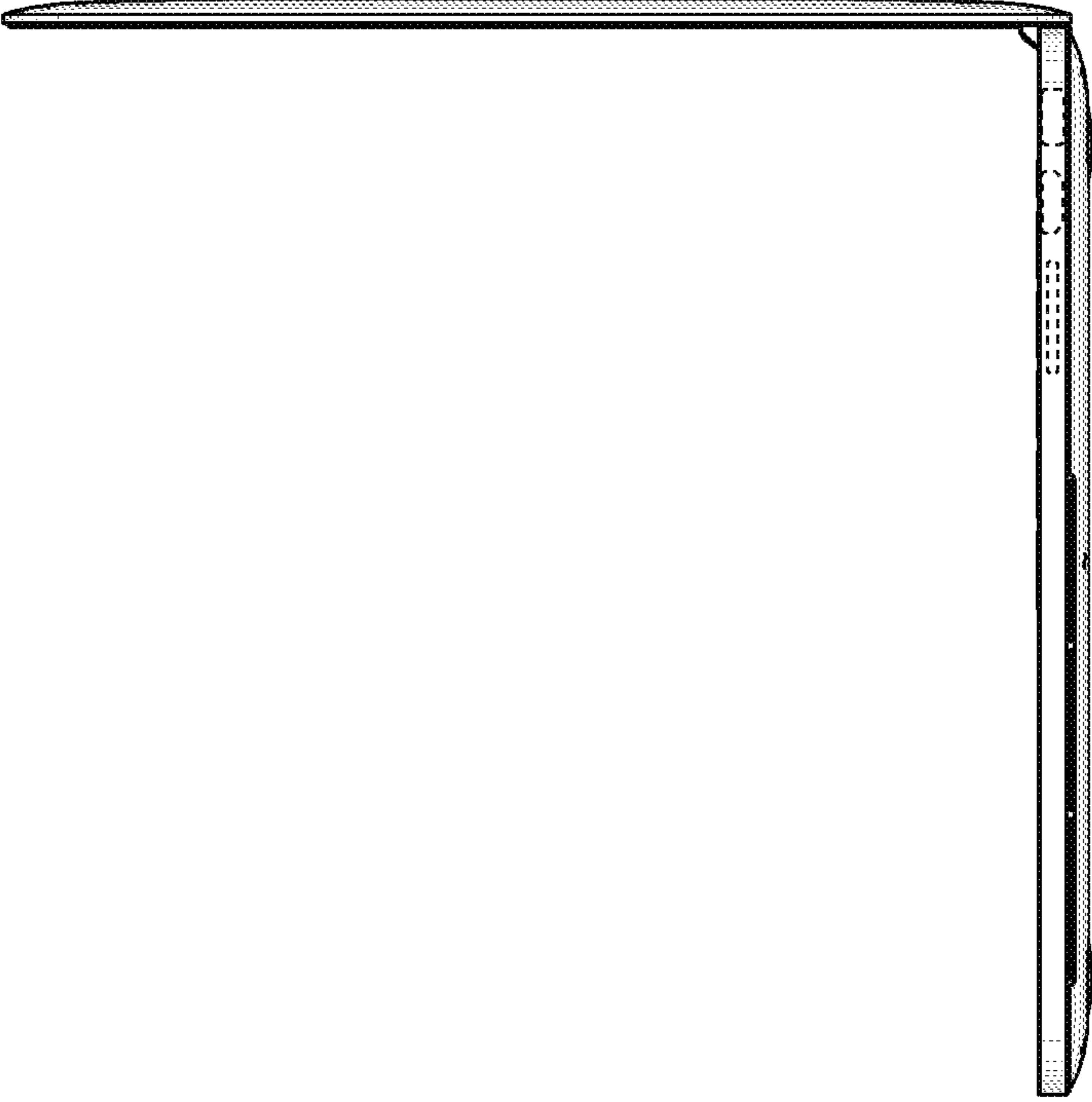

Fig. 62

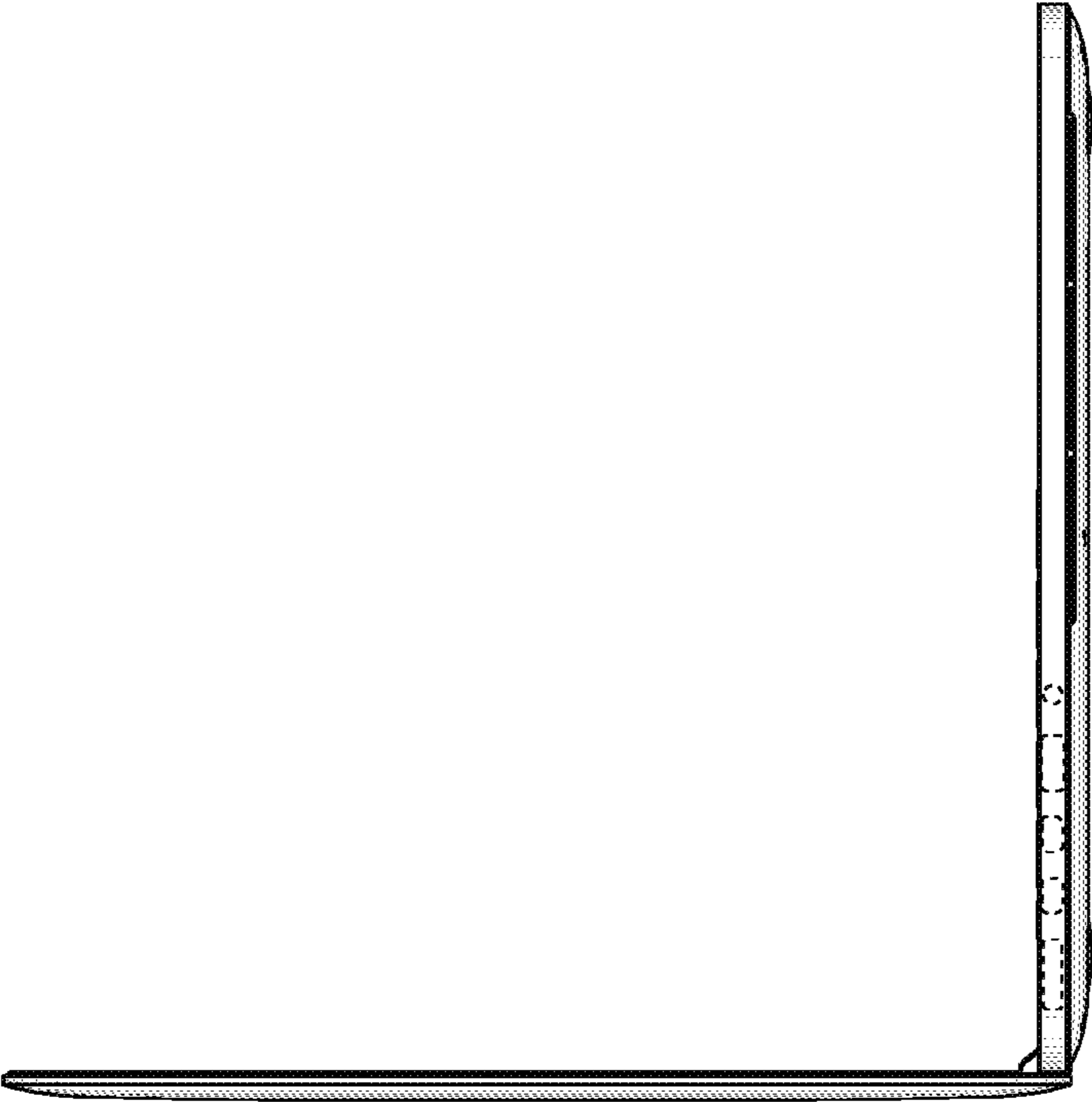

Fig. 61

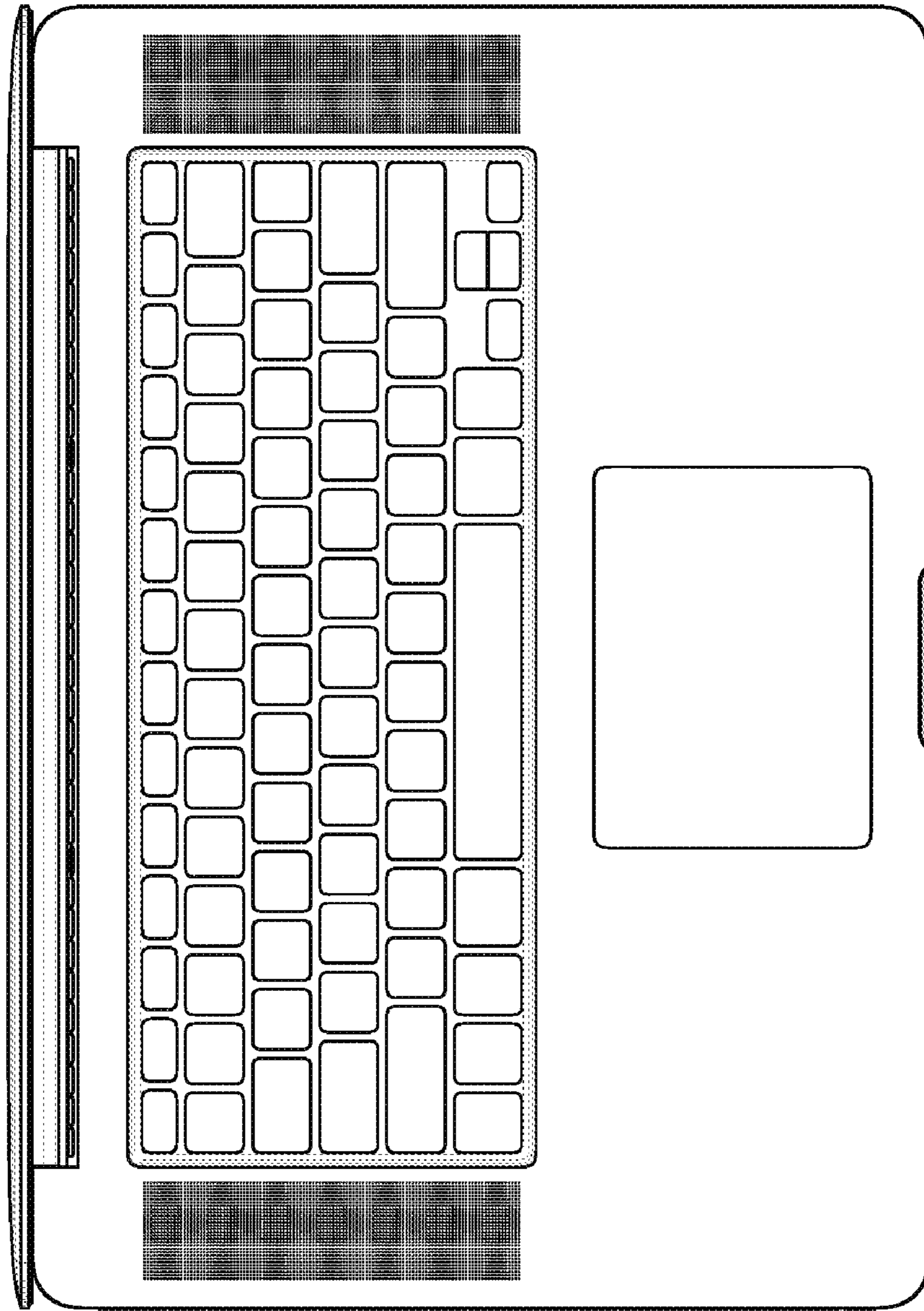

Fig. 63

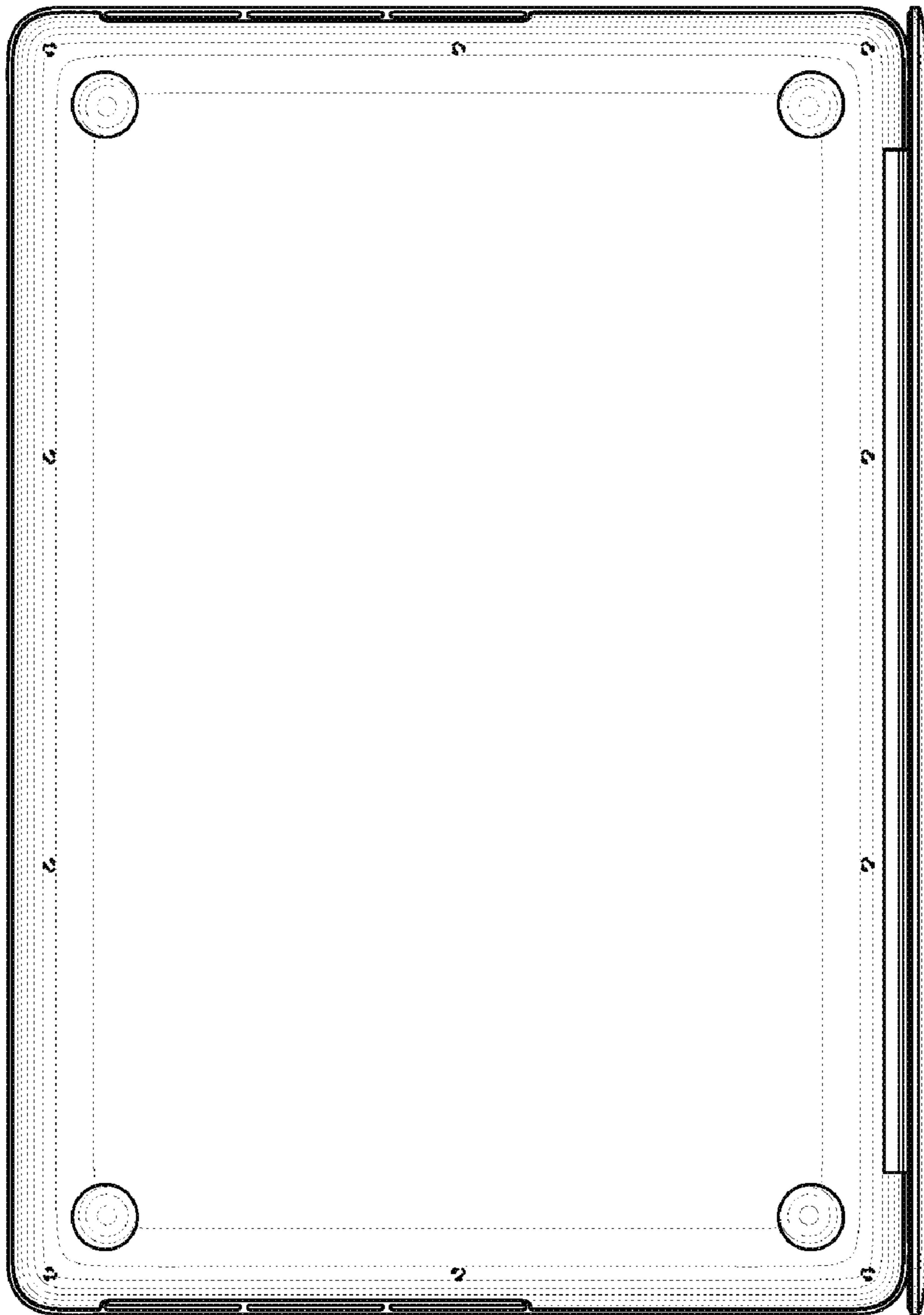

Fig. 64