



US00D676432S

(12) **United States Design Patent**  
**Hasbrook et al.**

(10) **Patent No.:** **US D676,432 S**  
(45) **Date of Patent:** **\*\* Feb. 19, 2013**

(54) **SNAP MOBILE PHONE CASE**

(75) Inventors: **William Benjamin Hasbrook**, Tualatin, OR (US); **Sean Michael Stuck**, Portland, OR (US); **William Westwood**, Escondido, CA (US); **Souheil Gallouzi**, San Diego, CA (US)

(73) Assignee: **mophie, LLC**, Santa Ana, CA (US)

(\*\*) Term: **14 Years**

(21) Appl. No.: **29/382,268**

(22) Filed: **Dec. 30, 2010**

(51) **LOC (9) Cl.** ..... **14-03**

(52) **U.S. Cl.** ..... **D14/250**

(58) **Field of Classification Search** ..... D14/248, D14/250–253, 440, 203.1–203.7, 217–218, D14/496, 137–138 AA, 138 G, 168, 474; D3/201, 218, 269, 301, 273, 303, 103, 247; D13/103, 107, 108, 119; D6/407; D21/333; 220/4.02; 361/679.56, 679.55, 679.01; 379/426, 379/433.11, 455; 455/575.1, 575.8; 190/100; 206/305, 320

See application file for complete search history.

(56) **References Cited**

**U.S. PATENT DOCUMENTS**

D428,019 S *	7/2000	Amron	.....	D14/203.7
D508,495 S *	8/2005	Bone et al.	.....	D14/203.7
D550,455 S *	9/2007	Barnhart	.....	D3/247
D557,494 S *	12/2007	Mayette et al.	.....	D3/218
D575,056 S *	8/2008	Tan	.....	D3/218
D603,603 S *	11/2009	Laine et al.	.....	D3/218
D609,463 S *	2/2010	Bullen	.....	D3/218
D616,360 S *	5/2010	Huang	.....	D13/103
D616,361 S *	5/2010	Huang	.....	D13/103
D623,180 S *	9/2010	Diebel	.....	D14/250
D623,640 S *	9/2010	Freeman	.....	D14/250
D624,908 S *	10/2010	Huskinson	.....	D14/250
D624,909 S *	10/2010	Huskinson	.....	D14/250
D626,538 S *	11/2010	Brown et al.	.....	D14/250
D626,539 S *	11/2010	Brown et al.	.....	D14/250
7,889,498 B2 *	2/2011	Diebel et al.	.....	361/679.56
D644,219 S *	8/2011	Sawada	.....	D14/345

D647,084 S *	10/2011	Fathollahi	.....	D14/250
D649,539 S *	11/2011	Hong	.....	D14/250
D650,810 S *	12/2011	Lemelman et al.	.....	D14/496
D653,202 S *	1/2012	Hasbrook et al.	.....	D13/103
D658,165 S *	4/2012	Freeman	.....	D14/250
D662,923 S *	7/2012	Piedra et al.	.....	D14/250
D663,263 S *	7/2012	Gupta et al.	.....	D13/103
2012/0013295 A1 *	1/2012	Yeh	.....	320/108

\* cited by examiner

*Primary Examiner* — Robert M Spear

*Assistant Examiner* — Vy Koenig

(74) *Attorney, Agent, or Firm* — Matthew D. Bottomly

(57) **CLAIM**

The ornamental design for a snap mobile phone case, as shown and described.

**DESCRIPTION**

FIG. 1 is a three-quarter perspective view of a mobile phone, a top portion of the snap mobile phone case, and a bottom portion of the snap mobile phone case disconnected;

FIG. 2 is a three-quarter perspective view of the mobile phone encased in the top portion of the snap mobile phone case with the bottom portion of the snap mobile phone case disconnected;

FIG. 3 is a front view of the mobile phone encased in the top portion of the snap mobile phone case with the bottom portion of the snap mobile phone case disconnected;

FIG. 4 is a left-side view of the mobile phone encased in the top portion of the snap mobile phone case with the bottom portion of the snap mobile phone case disconnected;

FIG. 5 is a rear view of the mobile phone encased in the top portion of the snap mobile phone case with the bottom portion of the snap mobile phone case disconnected;

FIG. 6 is a right-side view of the mobile phone encased in the top portion of the snap mobile phone case with the bottom portion of the snap mobile phone case disconnected;

FIG. 7 is a top view of the mobile phone encased in the top portion of the snap mobile phone case with the bottom portion of the snap mobile phone case disconnected;

FIG. 8 is a three-quarter perspective view of the mobile phone encased in the top portion of the snap mobile phone case with the bottom portion of the snap mobile phone case connected;

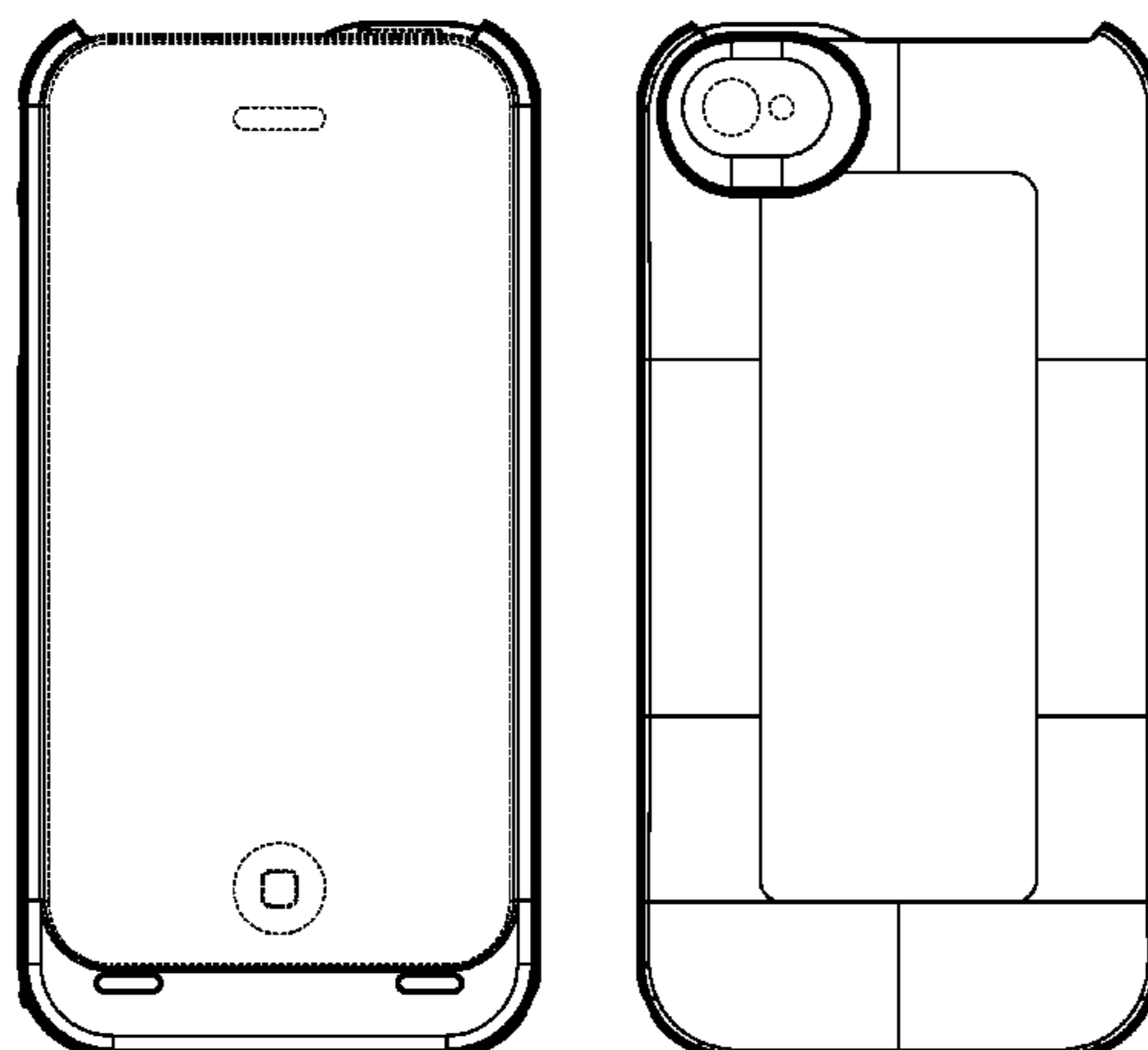

FIG. 9 is a front view of the mobile phone encased in the top portion of the snap mobile phone case with the bottom portion of the snap mobile phone case connected;

FIG. 10 is a left-side view of the mobile phone encased in the top portion of the snap mobile phone case with the bottom portion of the snap mobile phone case connected;

FIG. 11 is a rear view of the mobile phone encased in the top portion of the snap mobile phone case with the bottom portion of the snap mobile phone case connected;

FIG. 12 is a right-side view of the mobile phone encased in the top portion of the snap mobile phone case with the bottom portion of the snap mobile phone case connected;

FIG. 13 is a top view of the mobile phone encased in the top portion of the snap mobile phone case with the bottom portion of the snap mobile phone case connected;

FIG. 14 is a three-quarter perspective view of the top portion of the snap mobile phone case with the bottom portion of the snap mobile phone case disconnected;

FIG. 15 is a front view of the top portion of the snap mobile phone case with the bottom portion of the snap mobile phone case disconnected;

FIG. 16 is a left-side view of the top portion of the snap mobile phone case with the bottom portion of the snap mobile phone case disconnected;

FIG. 17 is a rear view of the top portion of the snap mobile phone case with the bottom portion of the snap mobile phone case disconnected;

FIG. 18 is a right-side view of the top portion of the snap mobile phone case with the bottom portion of the snap mobile phone case disconnected;

FIG. 19 is a three-quarter perspective view of the top portion of the snap mobile phone case with the bottom portion of the snap mobile phone case connected;

FIG. 20 is a front view of the top portion of the snap mobile phone case with the bottom portion of the snap mobile phone case connected;

FIG. 21 is a left-side view of the top portion of the snap mobile phone case with the bottom portion of the snap mobile phone case connected;

FIG. 22 is a rear view of the top portion of the snap mobile phone case with the bottom portion of the snap mobile phone case connected;

FIG. 23 is a right-side view of the top portion of the snap mobile phone case with the bottom portion of the snap mobile phone case connected;

FIG. 24 is a top view of the top portion of the snap mobile phone case with the bottom portion of the snap mobile phone case connected; and,

FIG. 25 is a bottom view of the top portion of the snap mobile phone case with the bottom portion of the snap mobile phone case connected.

The broken lines in the drawings represent unclaimed environmental subject matter.

**1 Claim, 25 Drawing Sheets**

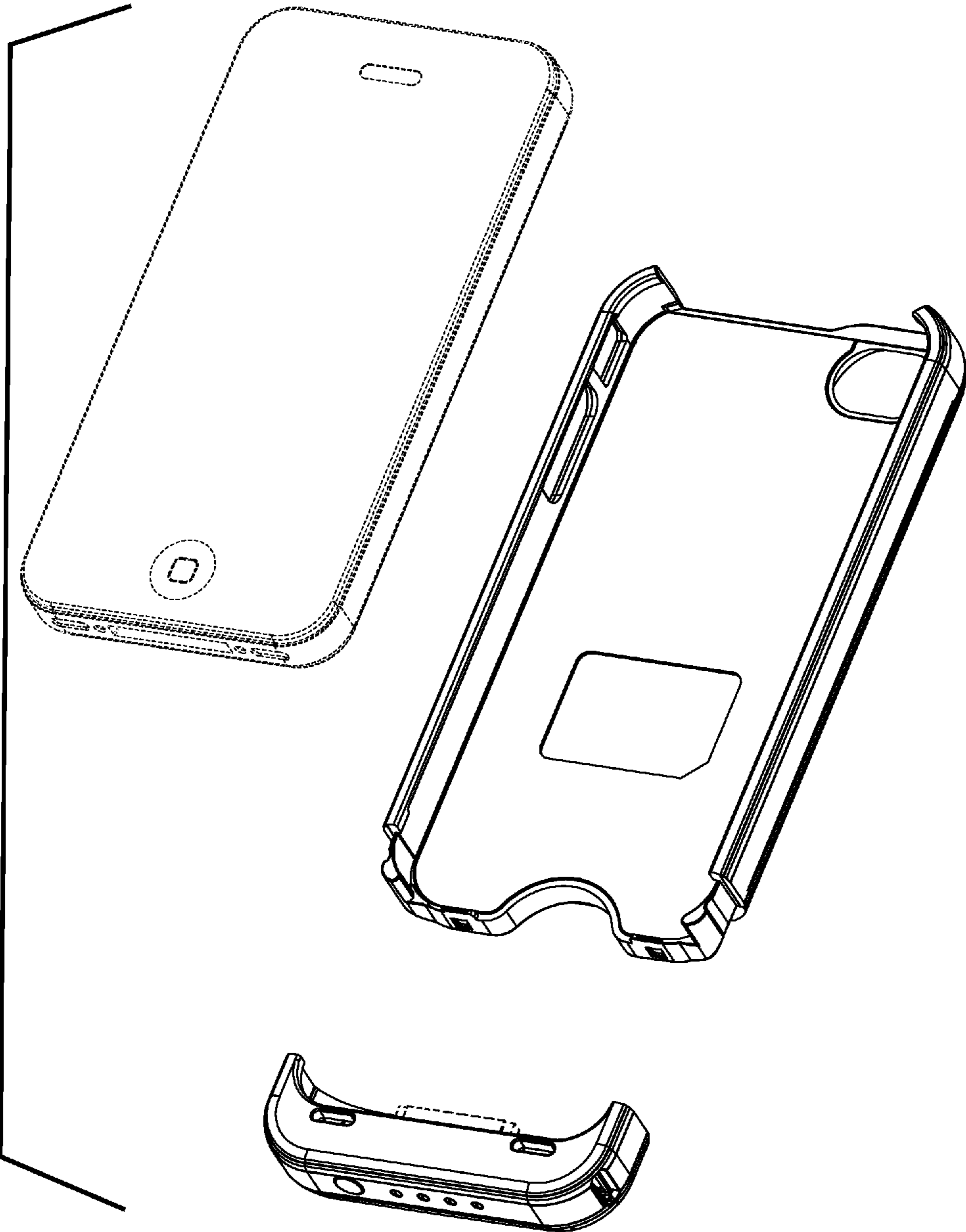

FIGURE 1



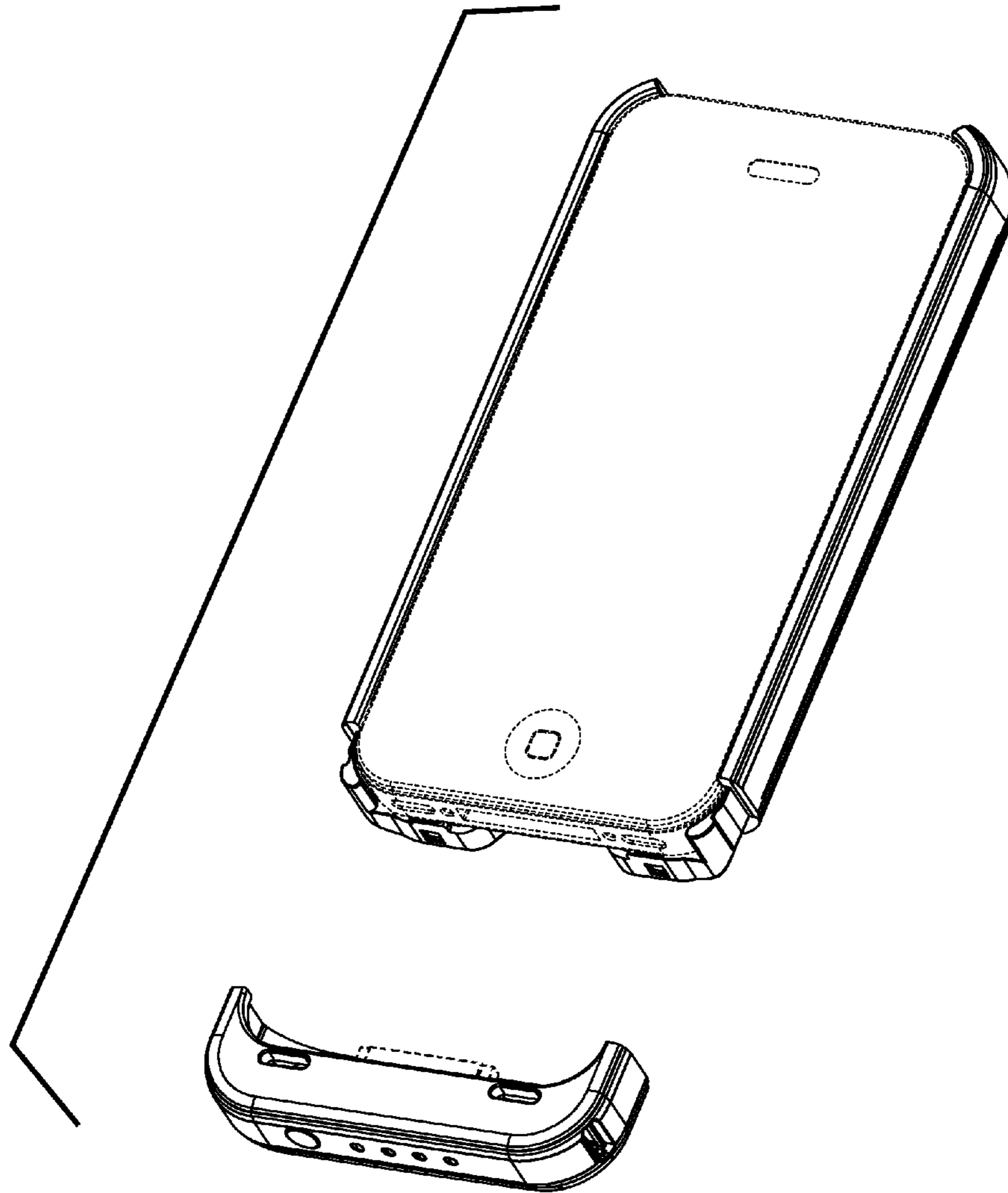

FIGURE 2

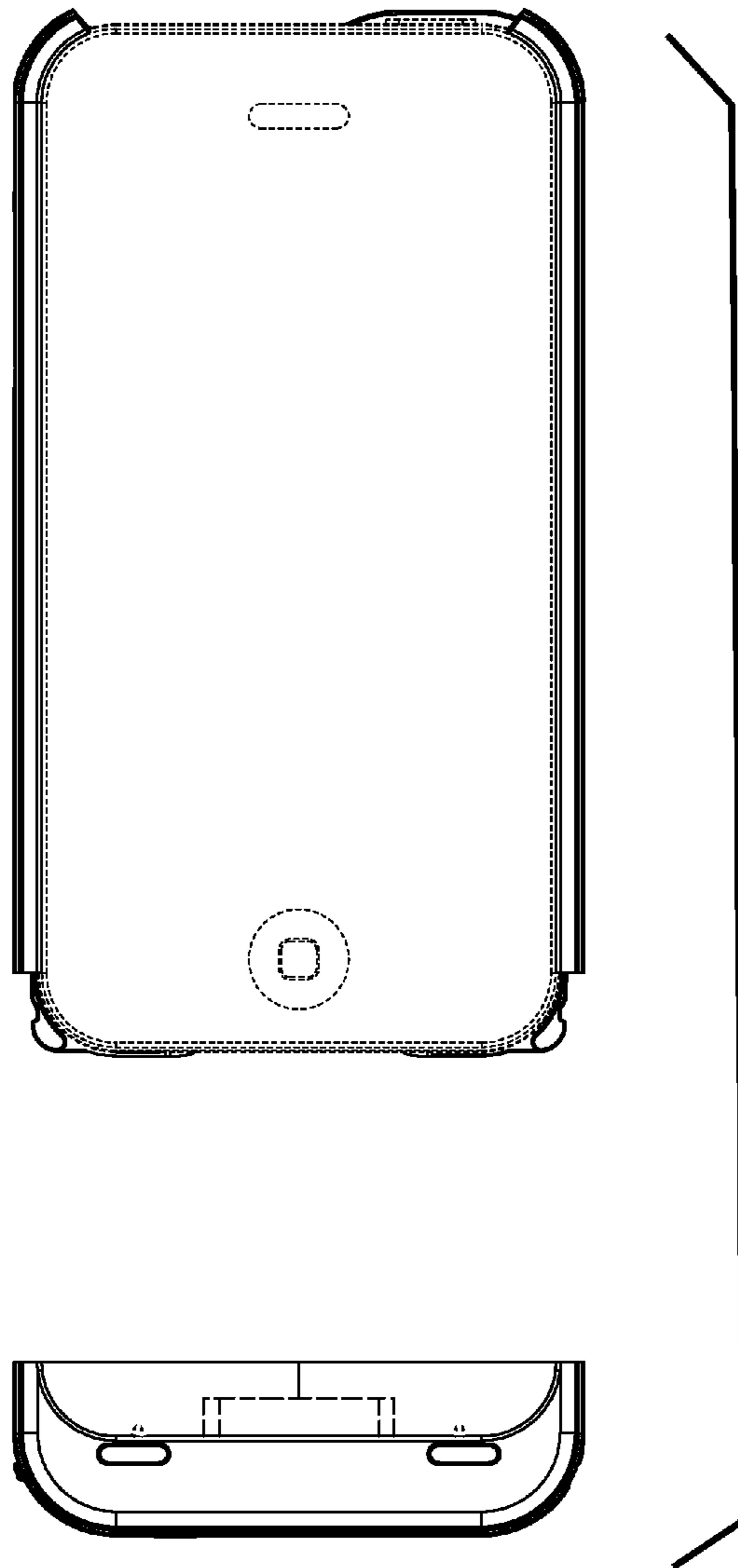

FIGURE 3

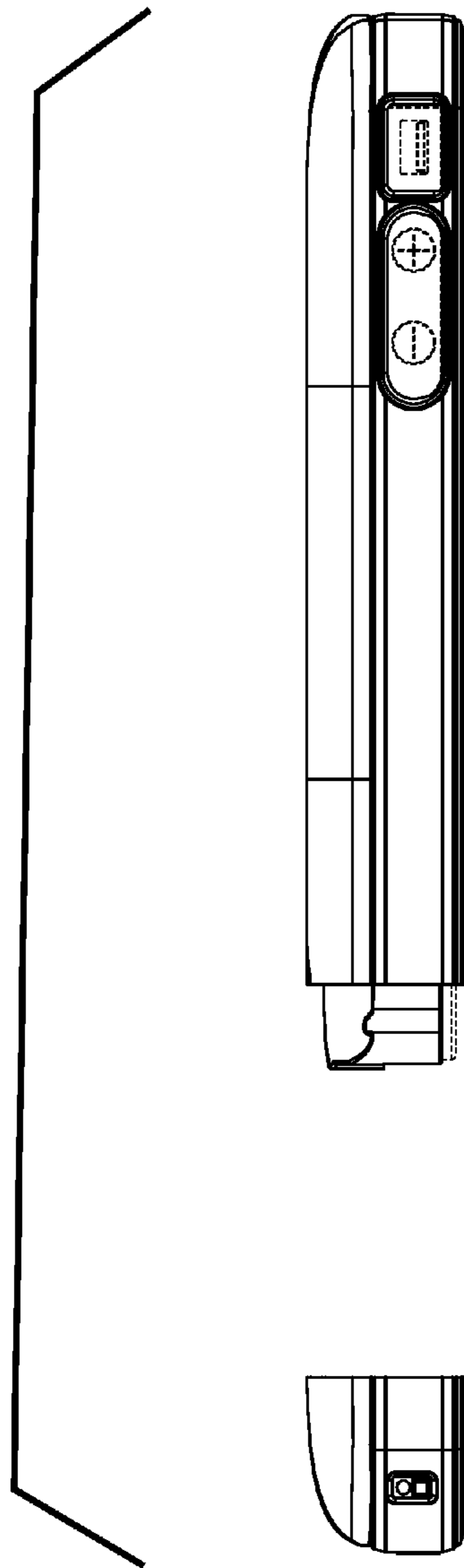

FIGURE 4

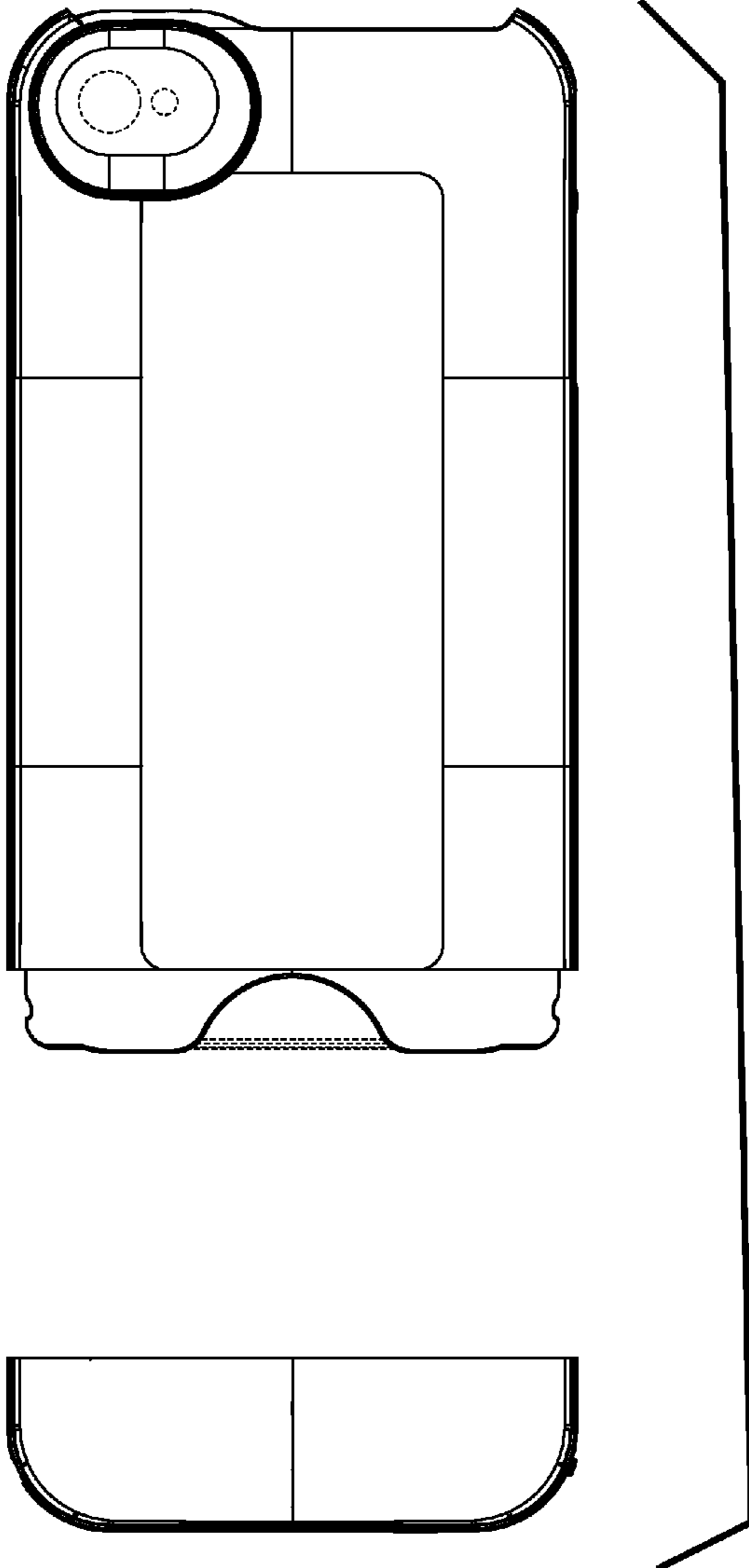

FIGURE 5

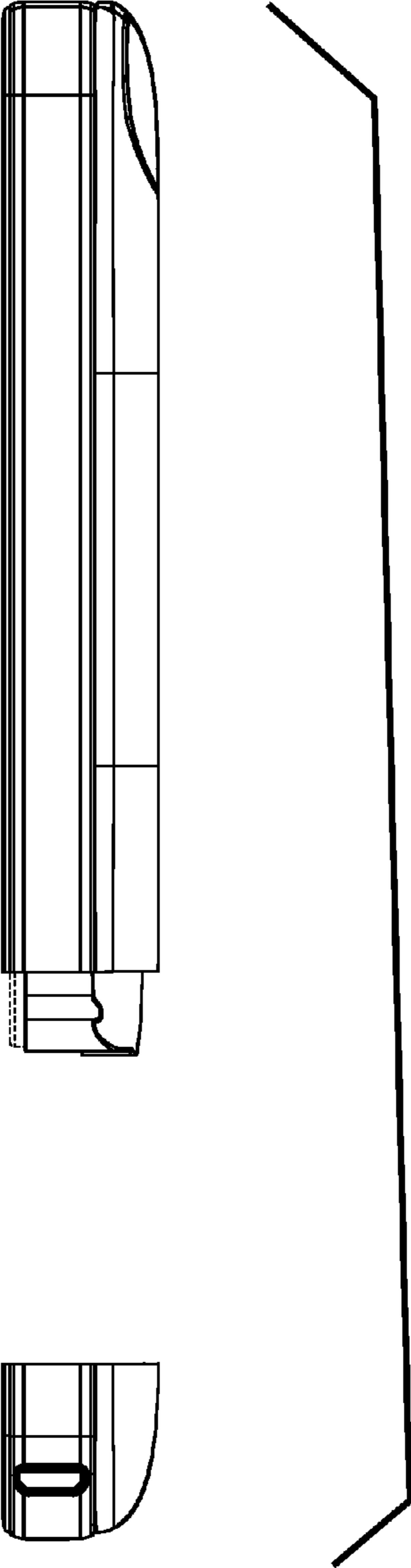

FIGURE 6





FIGURE 7

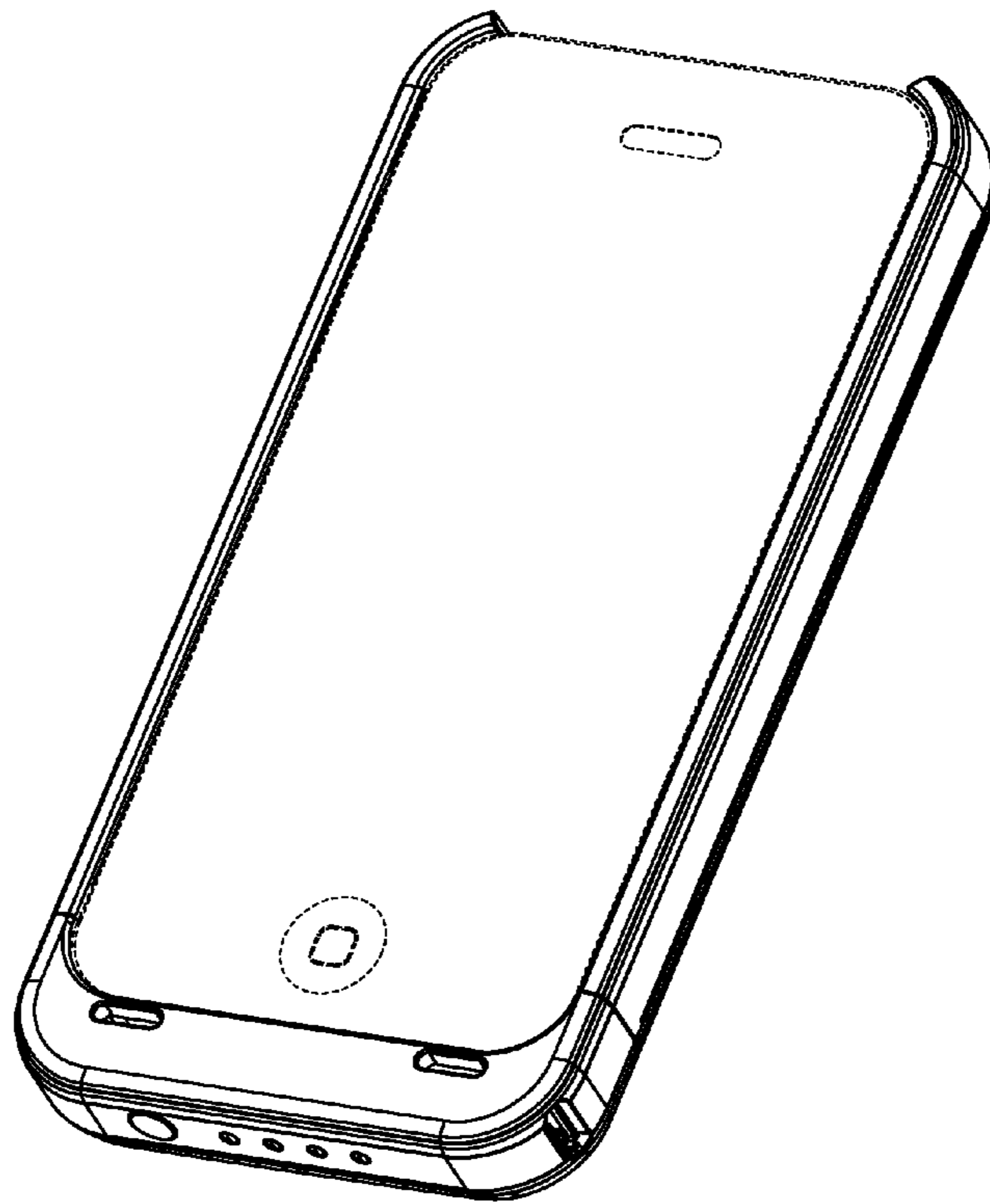

FIGURE 8

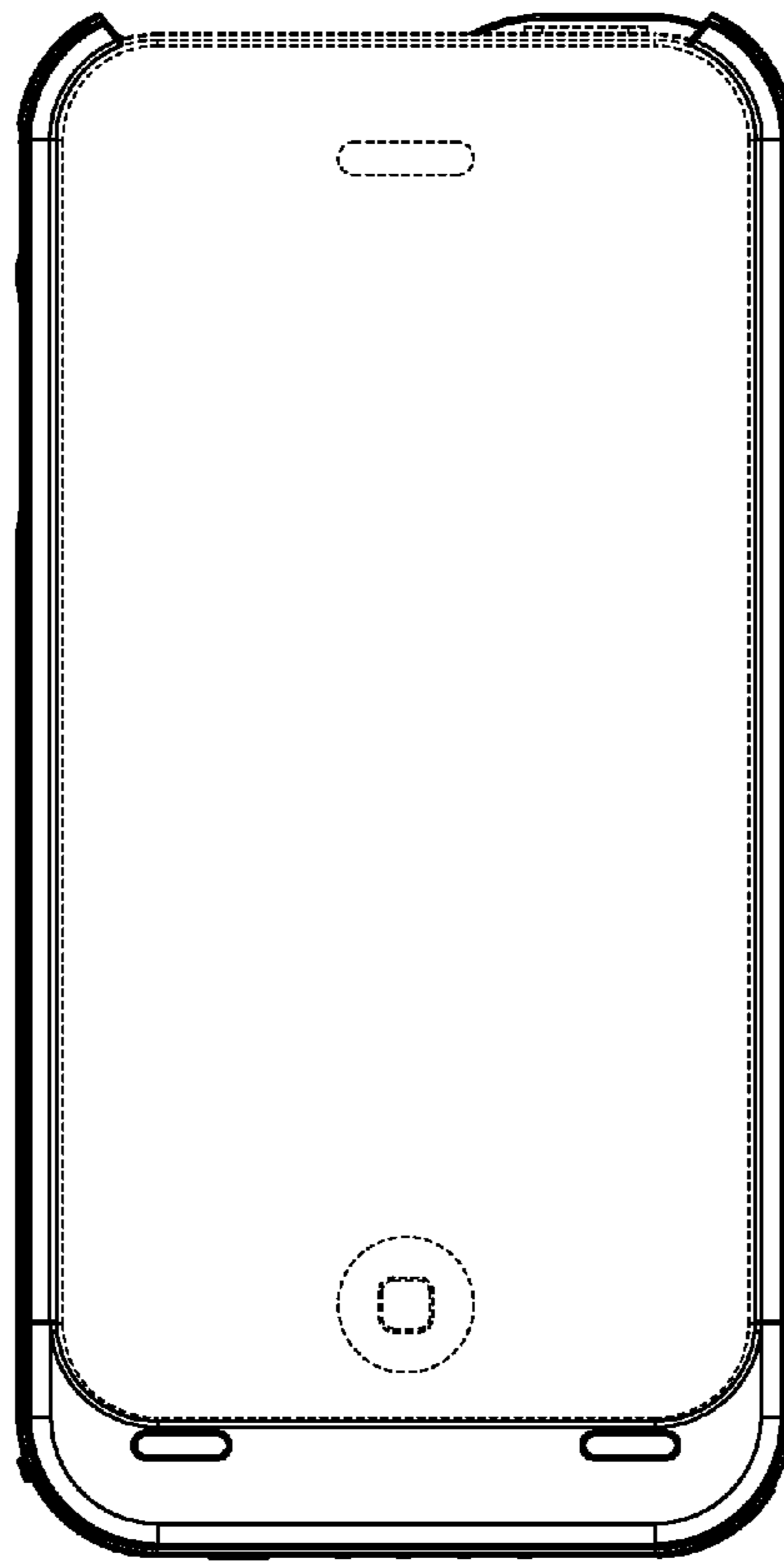

FIGURE 9

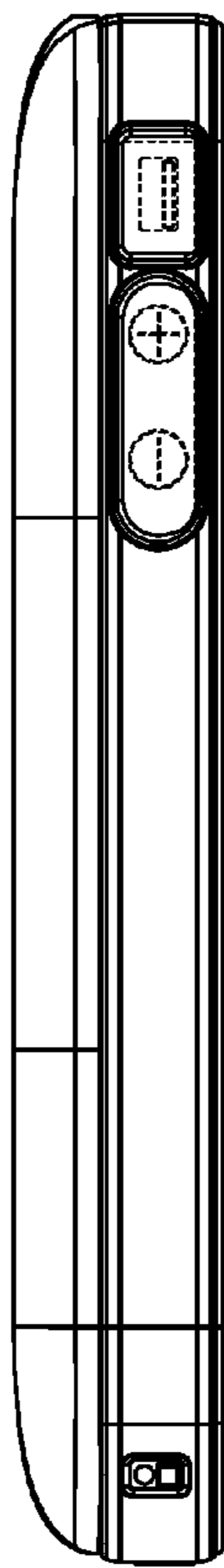

FIGURE 10

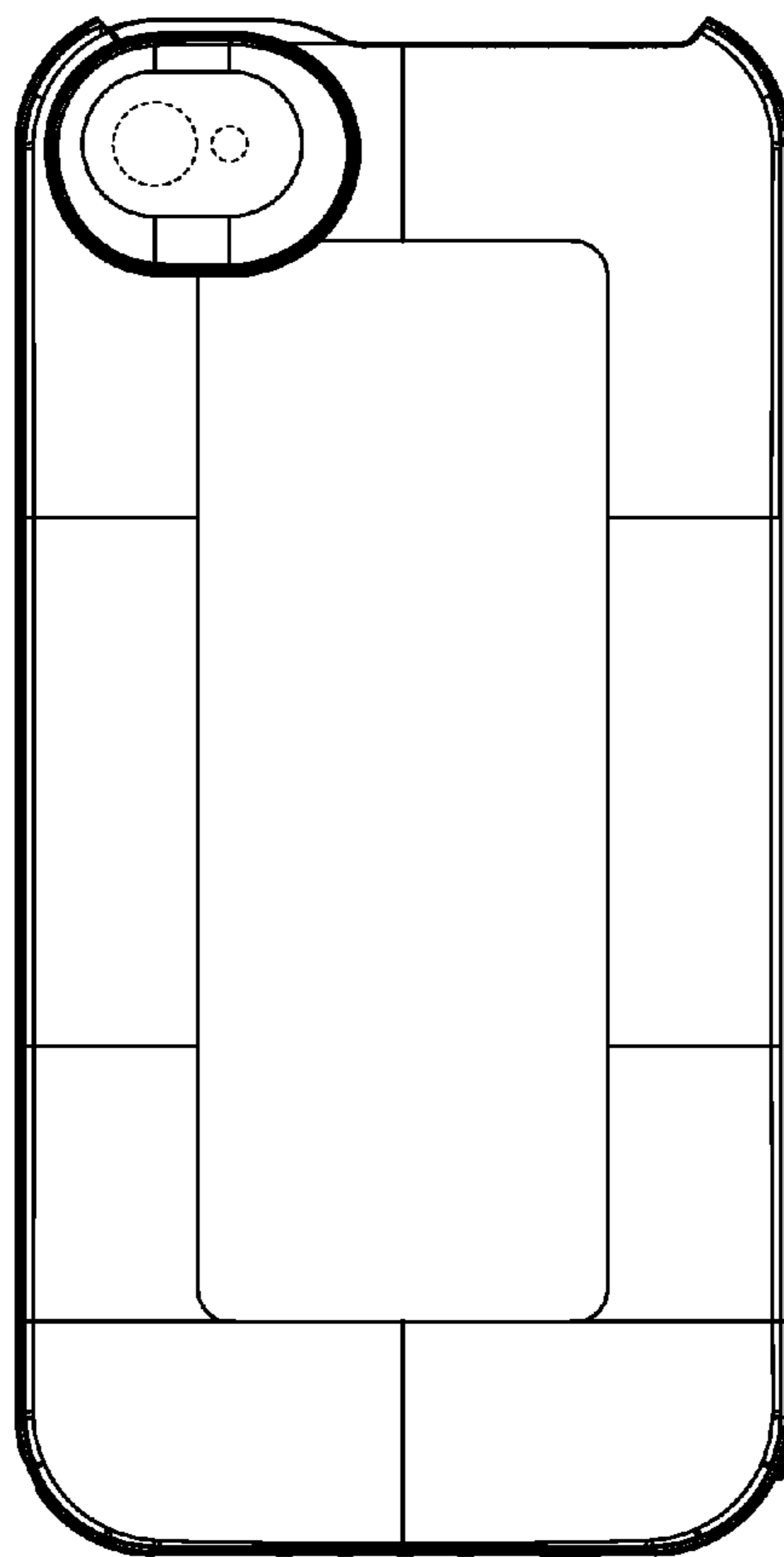

FIGURE 11

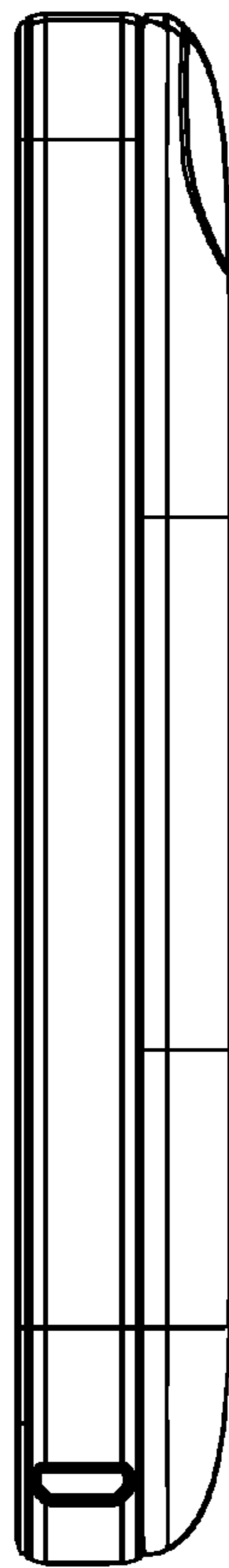

FIGURE 12



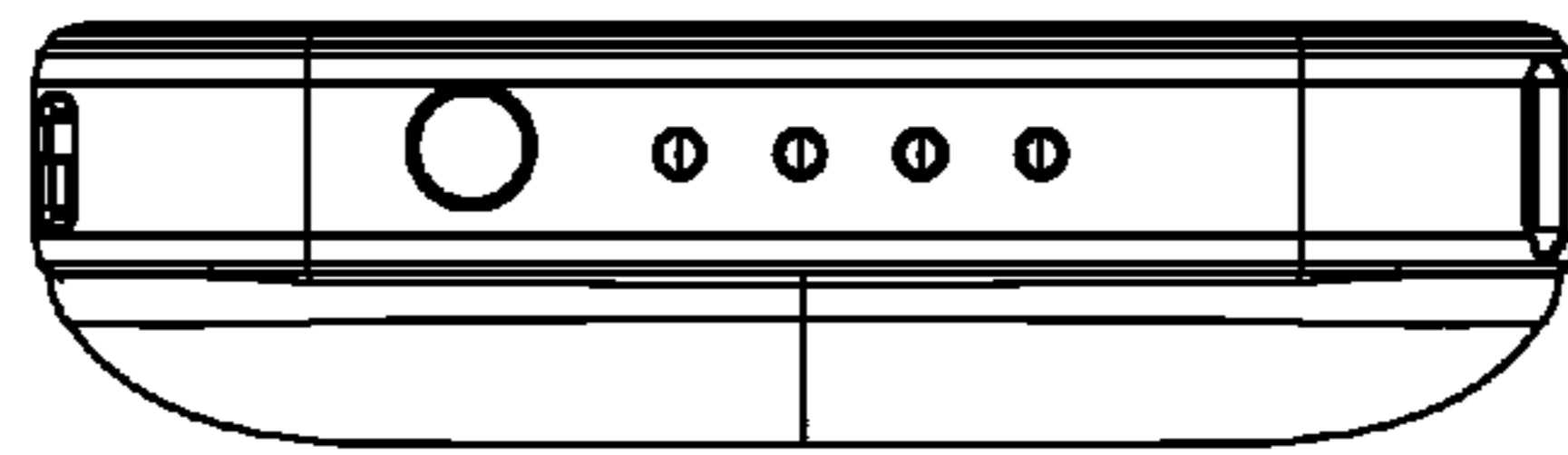

FIGURE 13

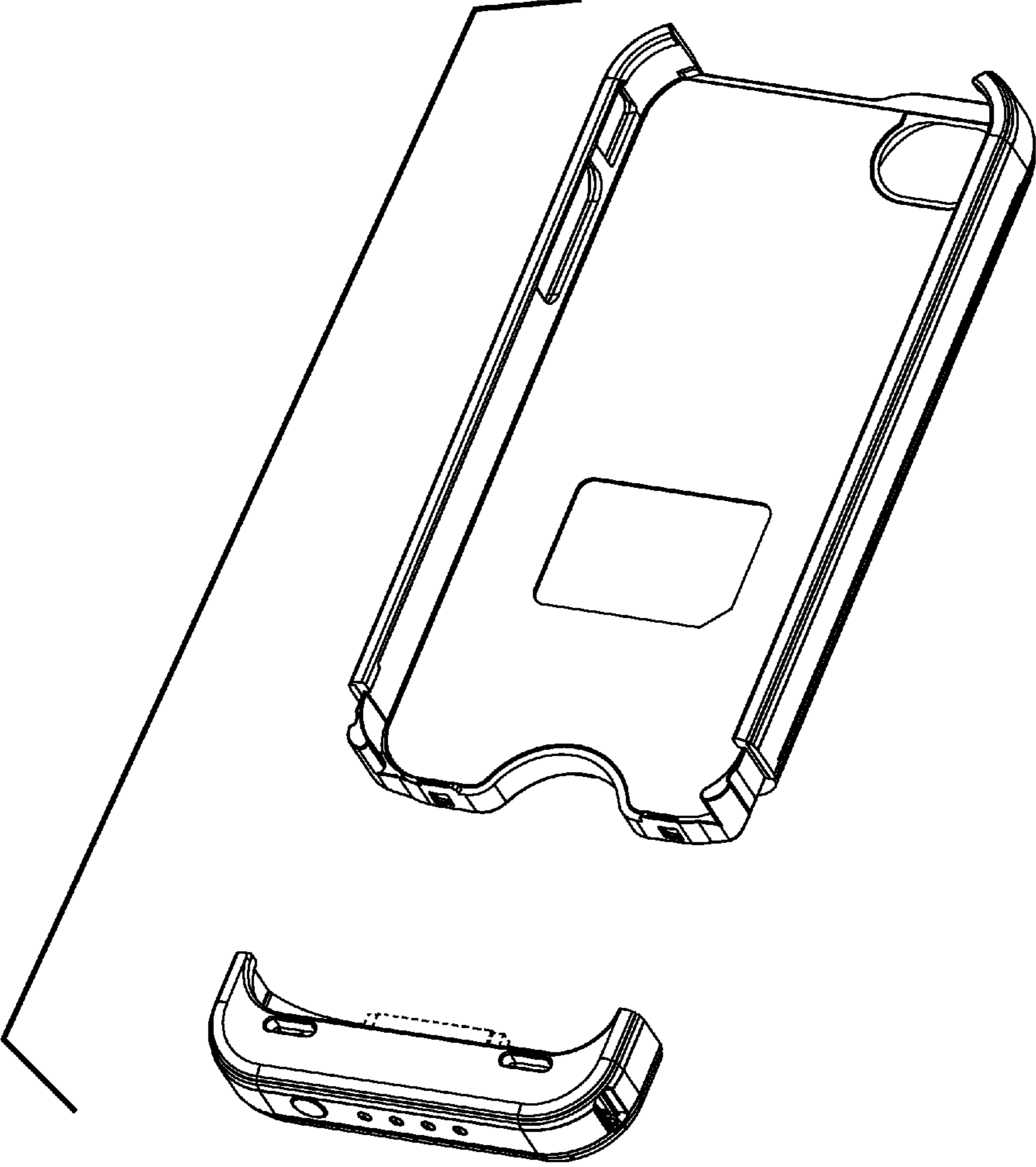

FIGURE 14

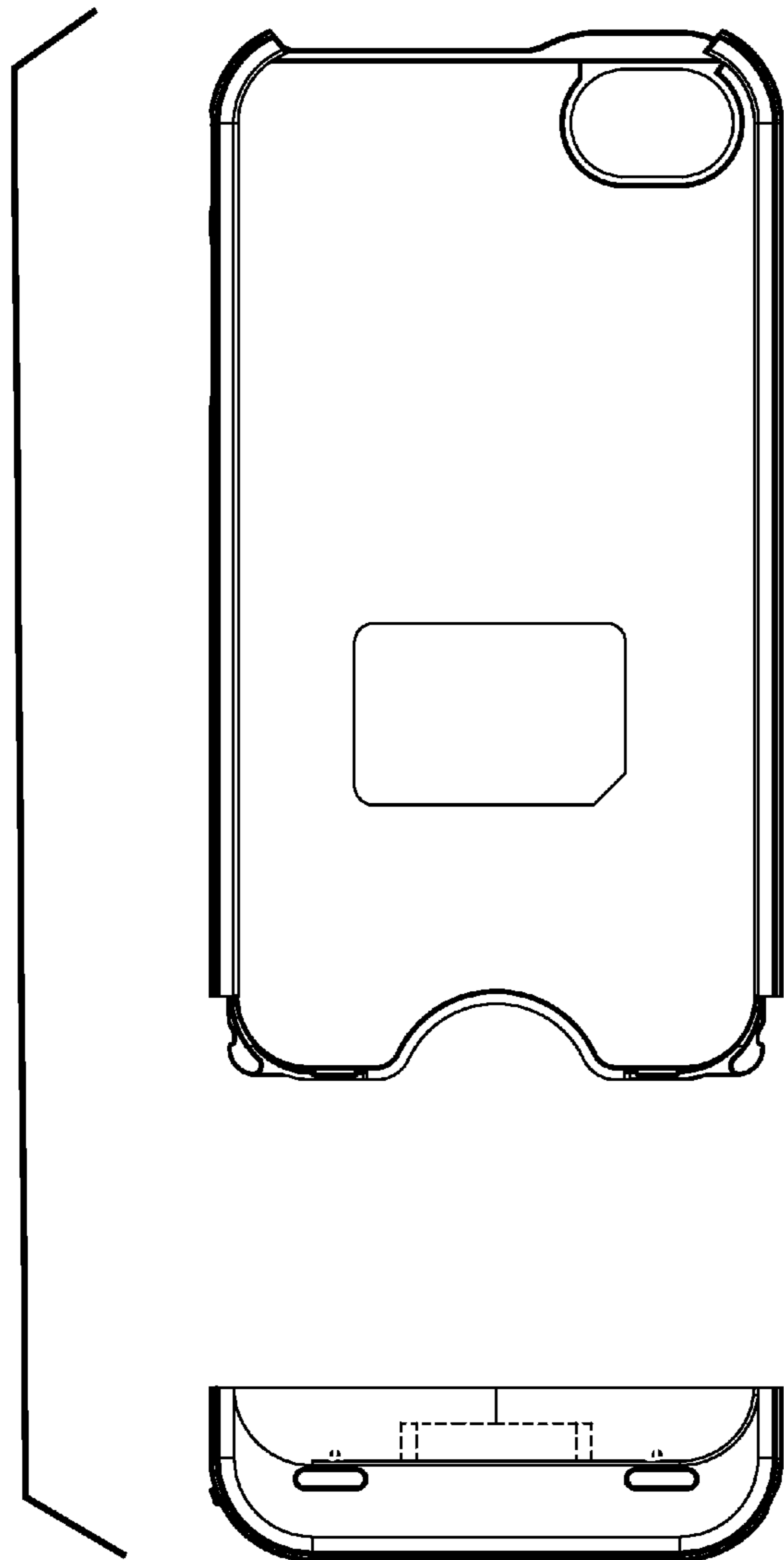

FIGURE 15

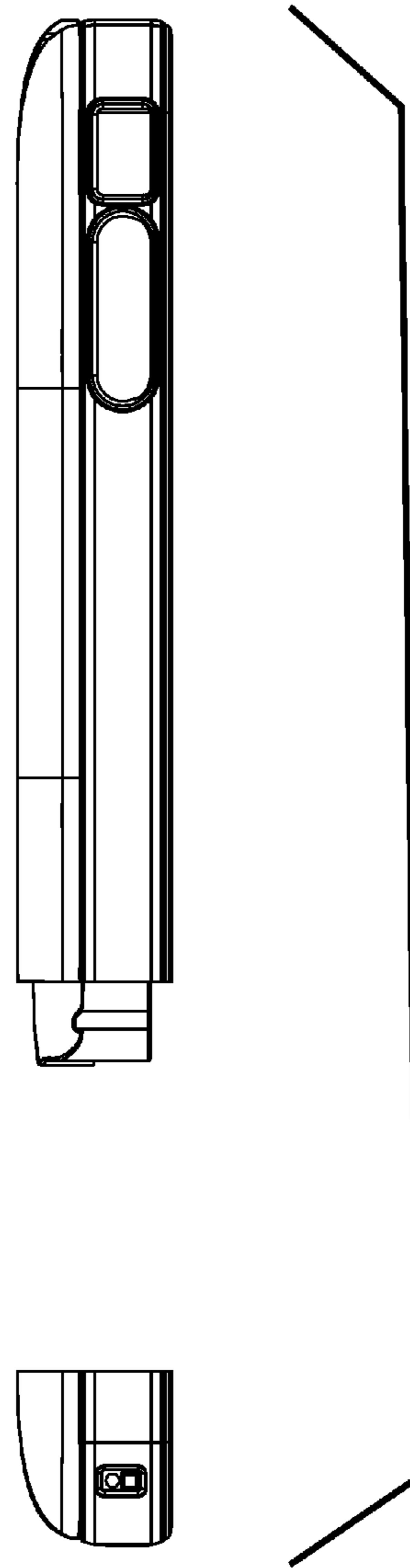

FIGURE 16

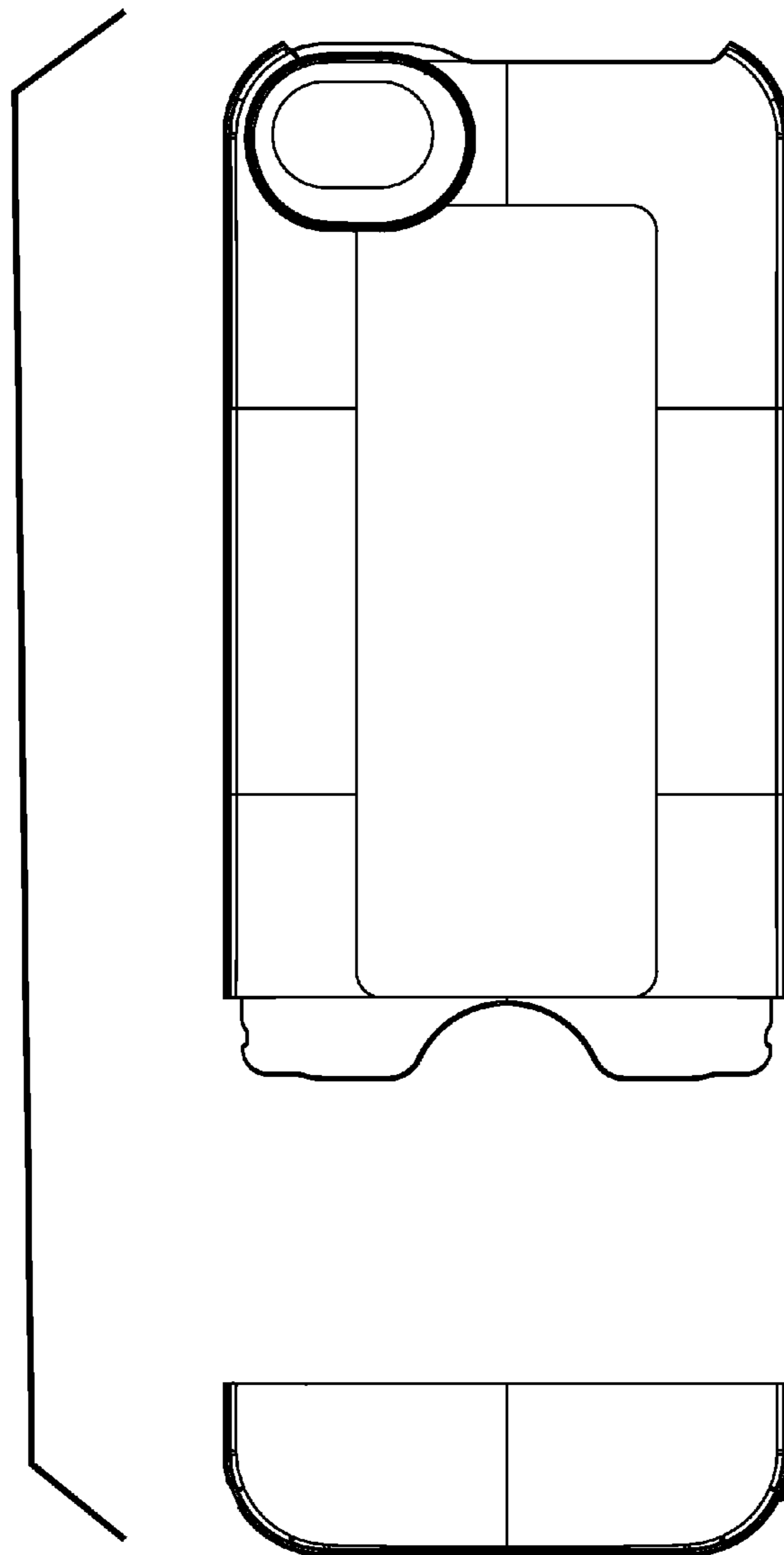

FIGURE 17

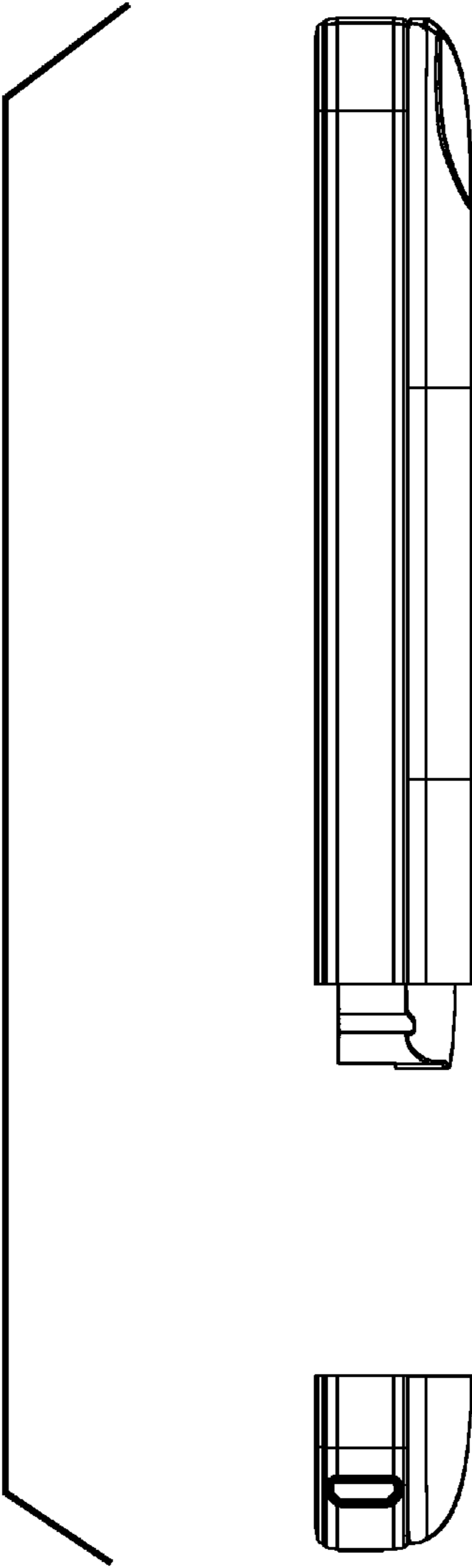

FIGURE 18



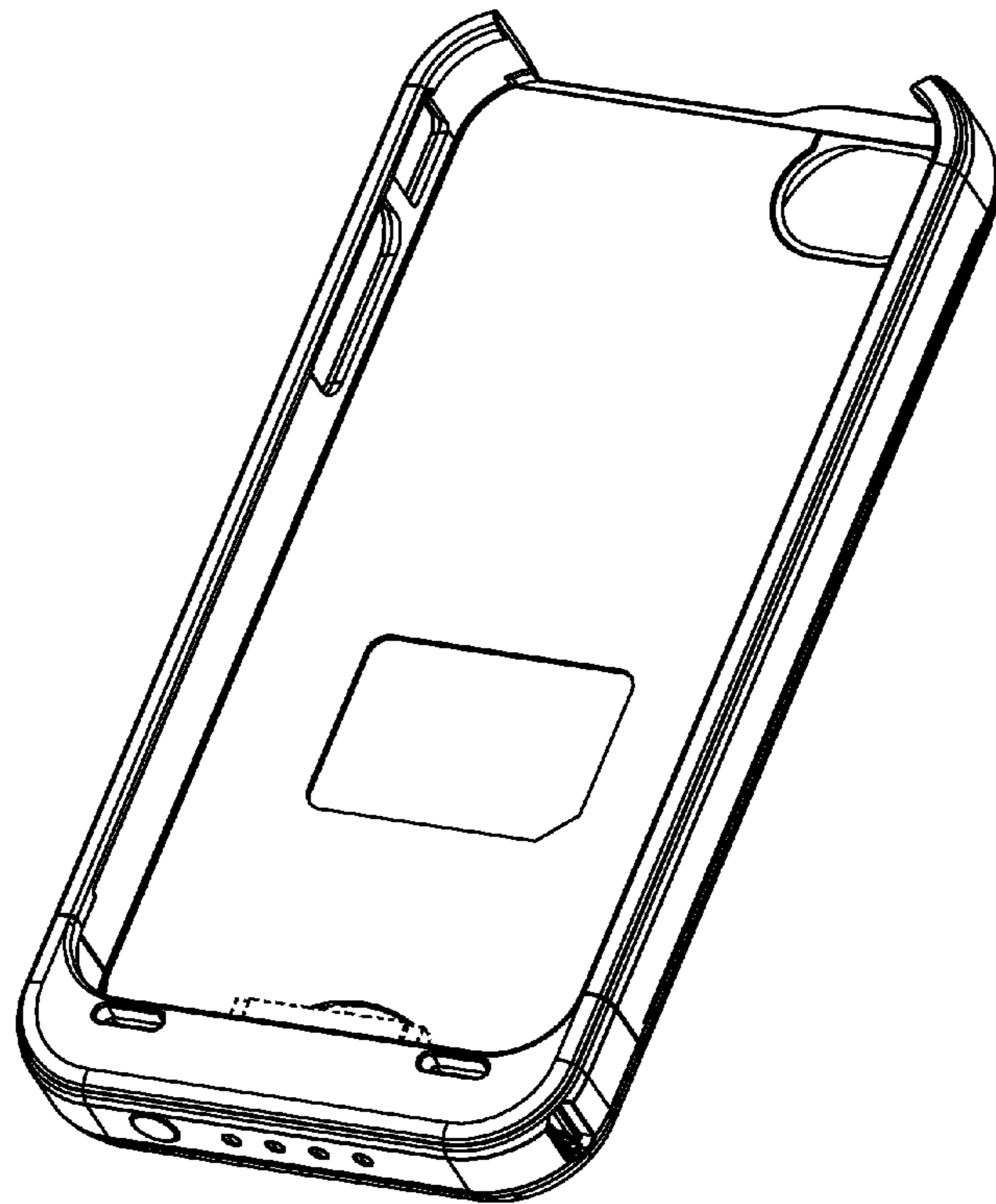

FIGURE 19

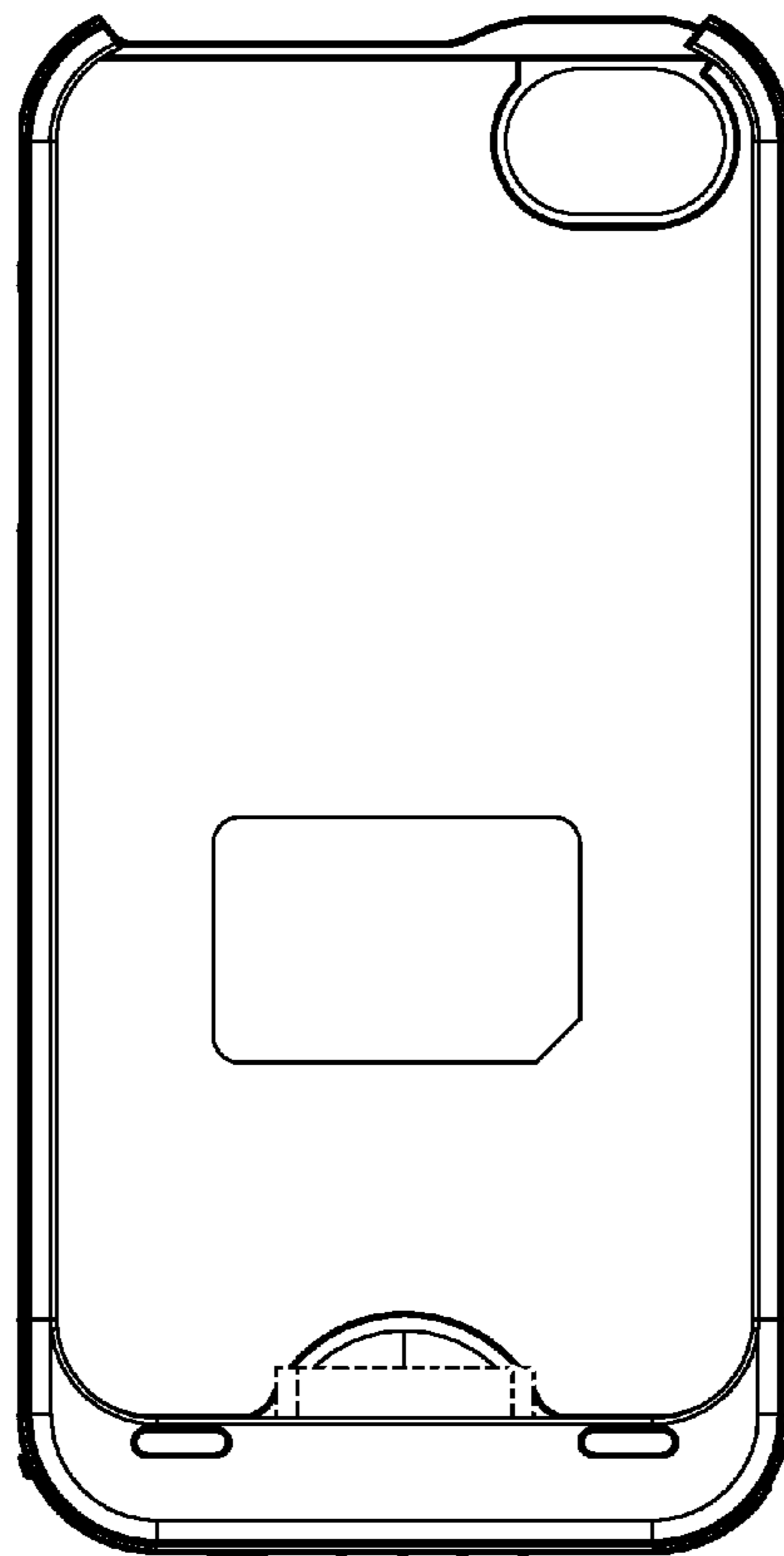

FIGURE 20



FIGURE 21

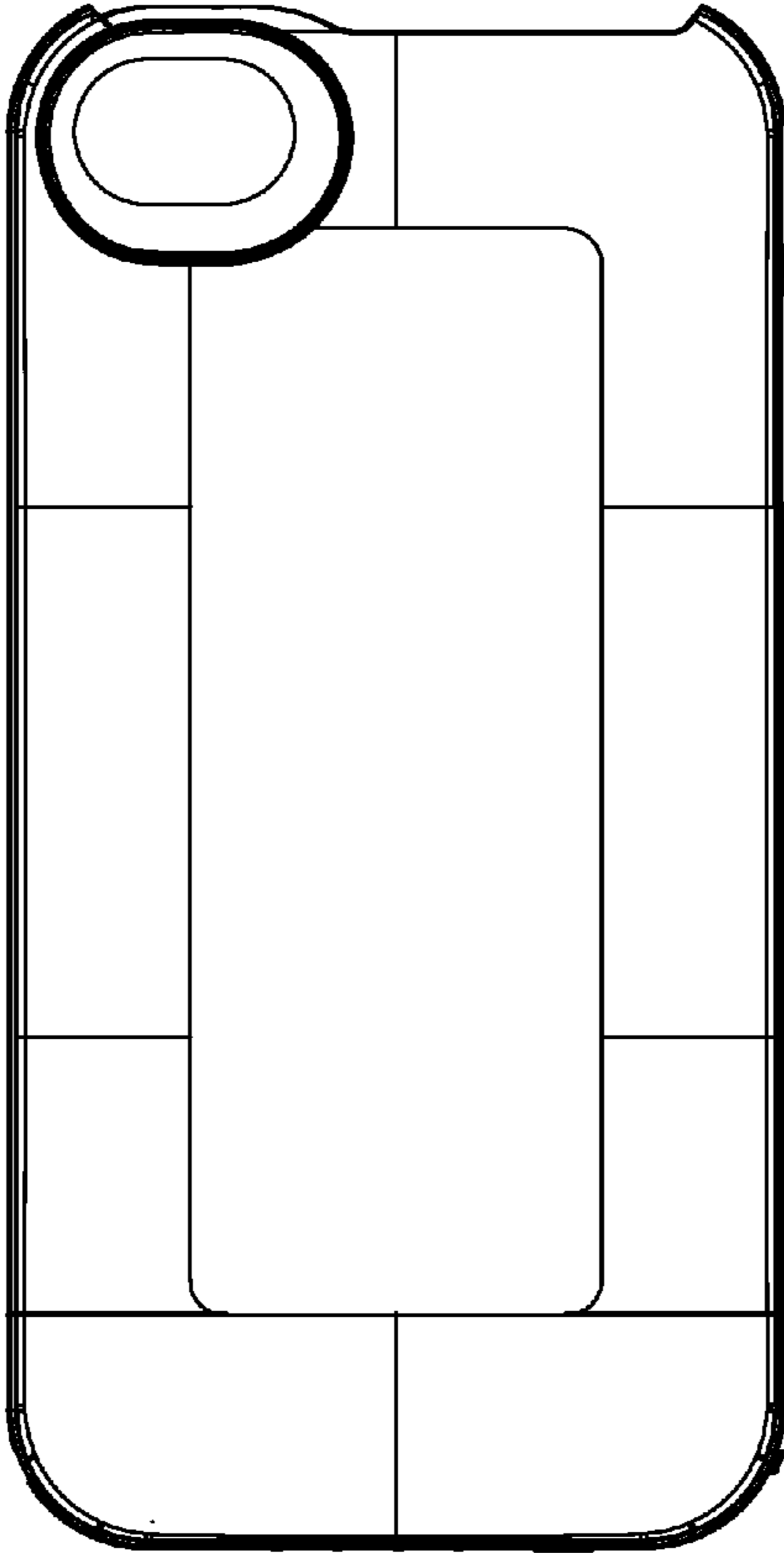

FIGURE 22

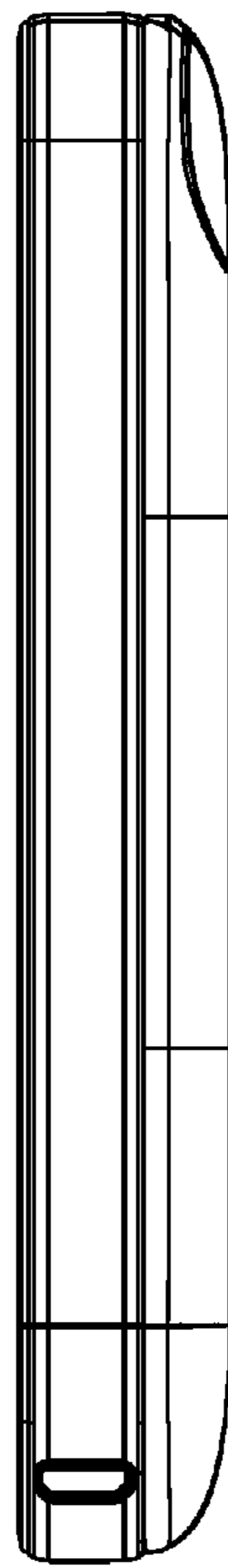

FIGURE 23

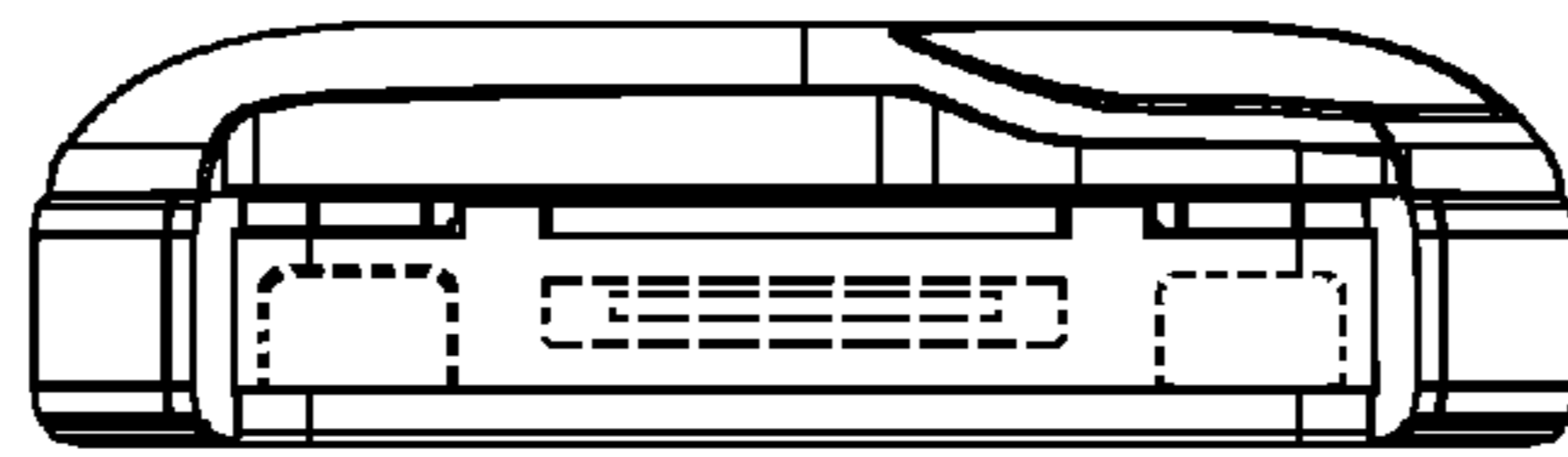

FIGURE 24



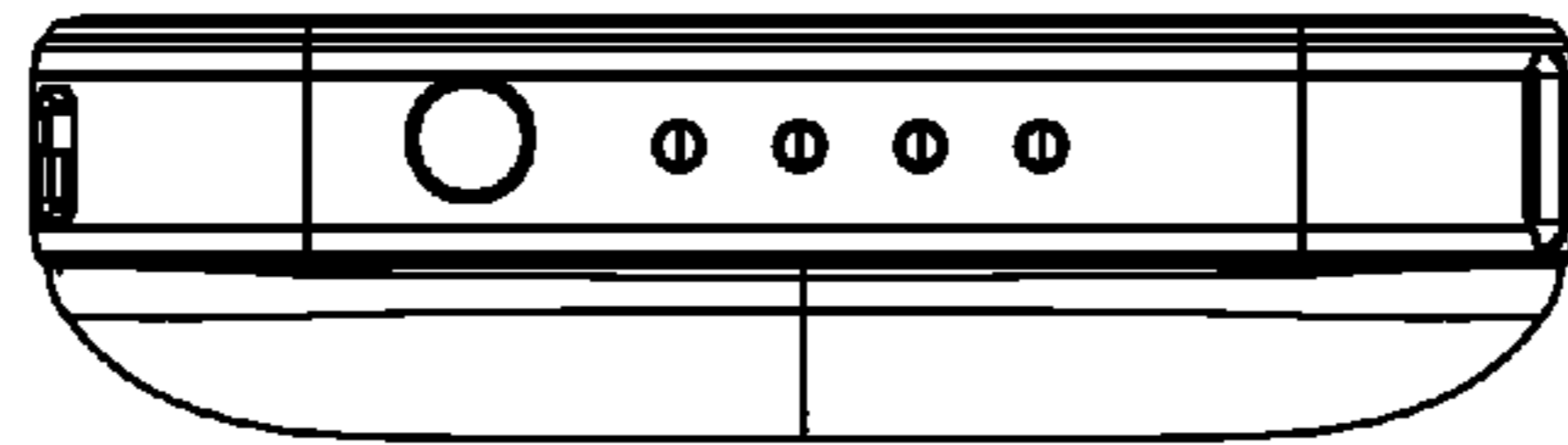

FIGURE 25