



US00D676349S

(12) **United States Design Patent**
Papadimitriou

(10) **Patent No.:** **US D676,349 S**

(45) **Date of Patent:** **** Feb. 19, 2013**

(54) **EARRING**

(75) Inventor: **Costantino Papadimitriou**, Milan (IT)

(73) Assignee: **De Beers Centenary AG**, Luzern (CH)

(**) Term: **14 Years**

(21) Appl. No.: **29/420,747**

(22) Filed: **May 11, 2012**

(51) **LOC (9) Cl.** **11-01**

(52) **U.S. Cl.** **D11/43**

(58) **Field of Classification Search** D11/79-85,
D11/89-91, 40-48, 1-8; 63/26-28, 12-14,
63/3, 3.1, 3.2

See application file for complete search history.

(56) **References Cited**

U.S. PATENT DOCUMENTS

D97,535 S *	11/1935	Mossman, Jr.	D11/80
D112,154 S *	11/1938	Verrecchio	D11/46
D164,717 S *	10/1951	Philippe	D11/85
D189,758 S	2/1961	Gibeault	
D301,315 S *	5/1989	Yoshida	D11/79
D429,474 S *	8/2000	Stein	D11/79
D467,193 S *	12/2002	Jongsoonthornthurakit ..	D11/79
D482,496 S *	11/2003	Jackel-Marken	D28/81
6,769,270 B2 *	8/2004	Takessian	63/29.1
D555,533 S *	11/2007	Gruosi-Scheufele	D11/43
D586,685 S *	2/2009	Grassi Damiani	D11/16
D619,031 S *	7/2010	Arlanda	D11/43
D622,625 S *	8/2010	Farsedakis	D11/1
D628,933 S *	12/2010	Hegi	D11/79
D639,692 S	6/2011	Papadimitriou	
D639,693 S	6/2011	Papadimitriou	
D644,141 S *	8/2011	George	D11/79
D654,822 S *	2/2012	Greppi	D11/86
D658,090 S *	4/2012	Papadimitriou	D11/43
D658,532 S *	5/2012	Papadimitriou	D11/79
D659,583 S *	5/2012	Papadimitriou	D11/43

D661,219 S *	6/2012	Papadimitriou	D11/43
D661,220 S *	6/2012	Papadimitriou	D11/79
D664,061 S *	7/2012	Papadimitriou	D11/43
D664,062 S *	7/2012	Papadimitriou	D11/43
2005/0199004 A1 *	9/2005	Bernsen	63/26

* cited by examiner

Primary Examiner — Cathron Brooks

Assistant Examiner — Melanie Pellegrini

(74) *Attorney, Agent, or Firm* — SNR Denton US LLP;
Brian R. McGinley

(57) **CLAIM**

The ornamental design for an earring, as shown and described.

DESCRIPTION

FIG. 1 is a top view of an earring illustrating the new design; FIG. 2 is a bottom view of the earring illustrated in FIG. 1; FIG. 3 is a left side elevational view of the earring illustrated in FIG. 1;

FIG. 4 is a right side elevational view of the earring illustrated in FIG. 1;

FIG. 5 is a front view of the earring shown in FIG. 1;

FIG. 6 is a rear view of the earring illustrated in FIG. 1;

FIG. 7 is a perspective view of the earring illustrated in FIG. 1;

FIG. 8 is a top view of a second embodiment of the earring;

FIG. 9 is a bottom view of the earring illustrated in FIG. 8;

FIG. 10 is a left side elevational view of the earring illustrated in FIG. 8;

FIG. 11 is a right side elevational view of the earring illustrated in FIG. 8;

FIG. 12 is a front view of the earring shown in FIG. 8;

FIG. 13 is a rear view of the earring illustrated in FIG. 8; and,

FIG. 14 is a perspective view of the earring illustrated in FIG. 8.

1 Claim, 7 Drawing Sheets

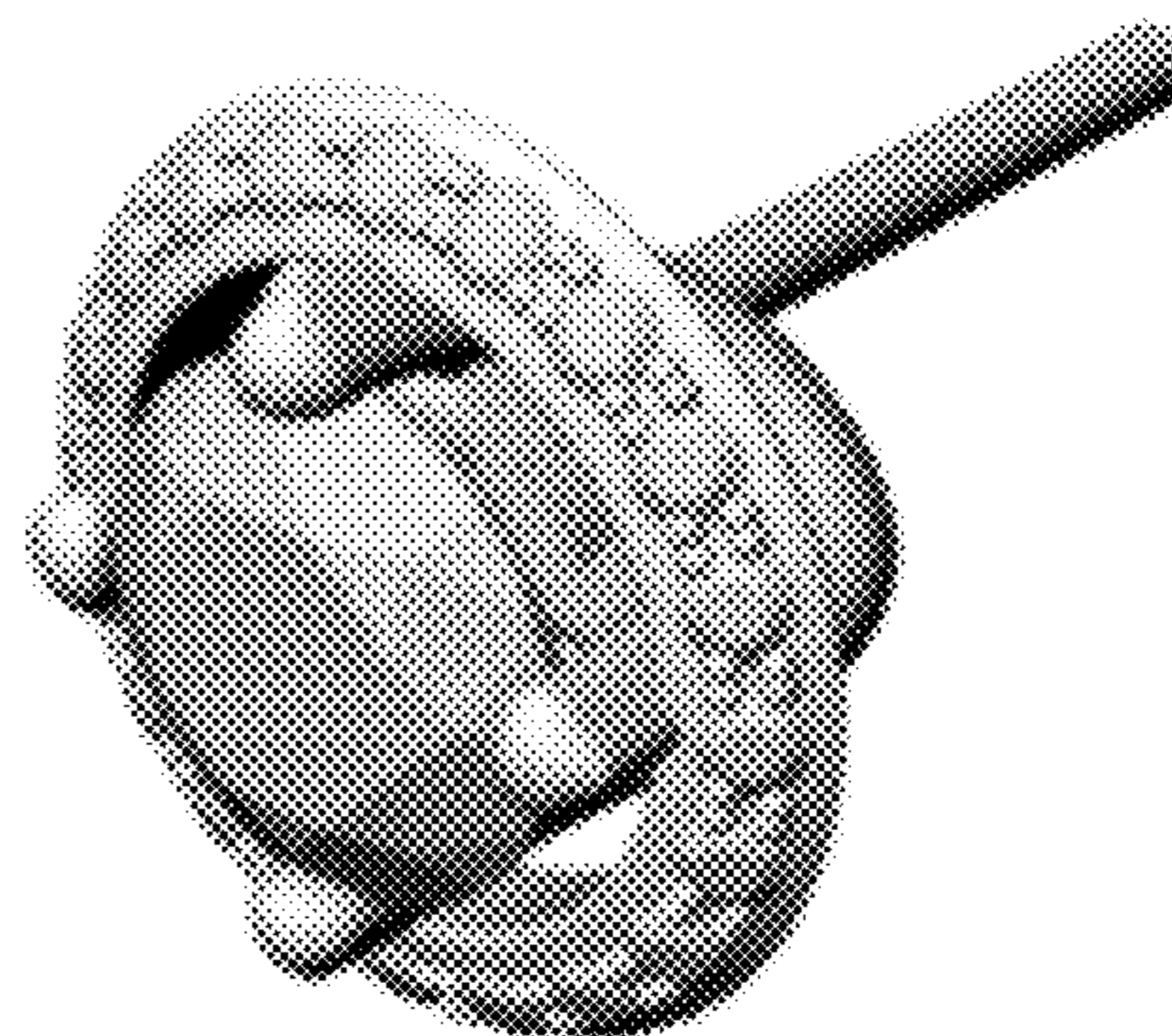
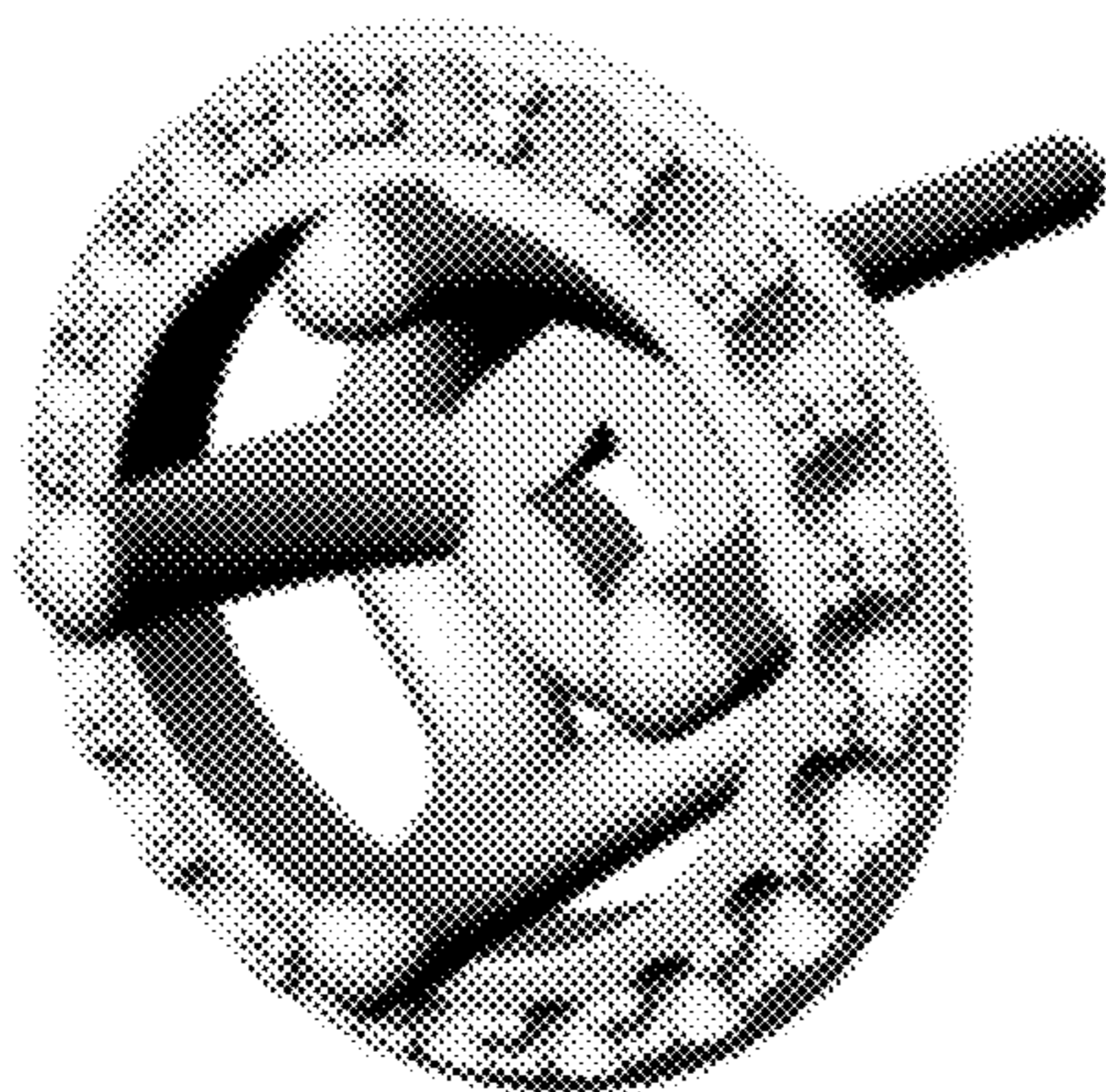

FIG. 1

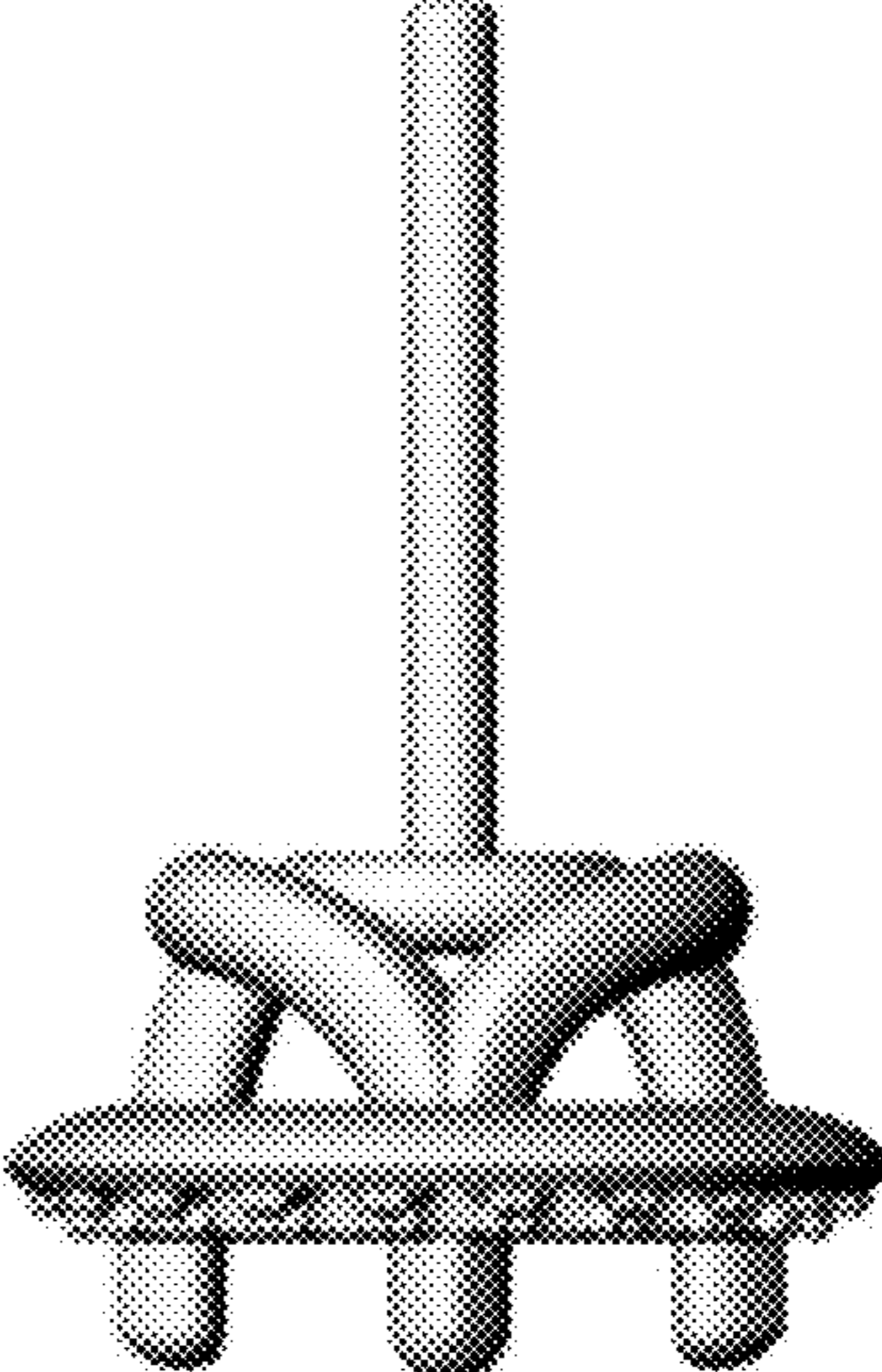

FIG. 2

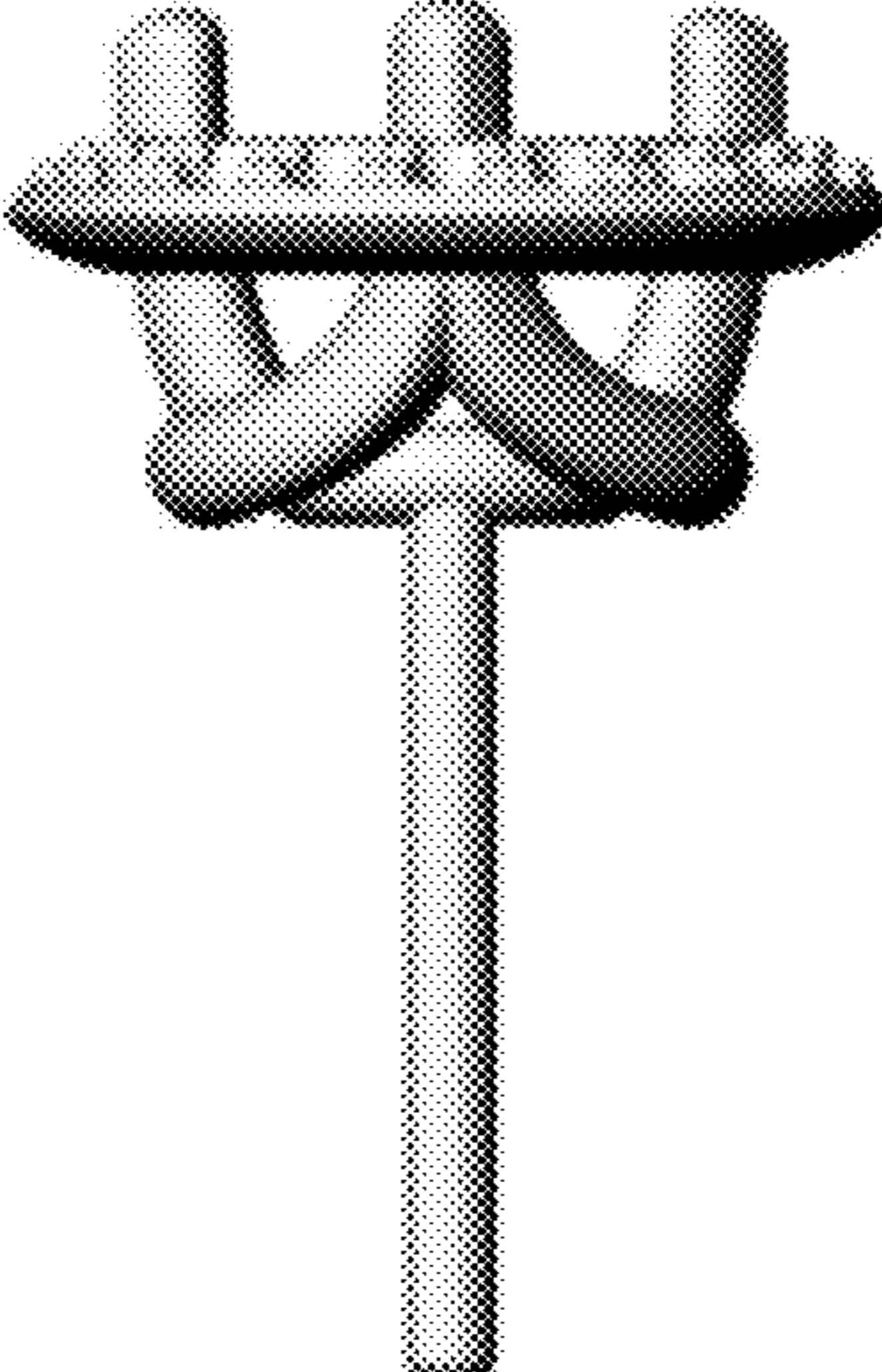

FIG. 3

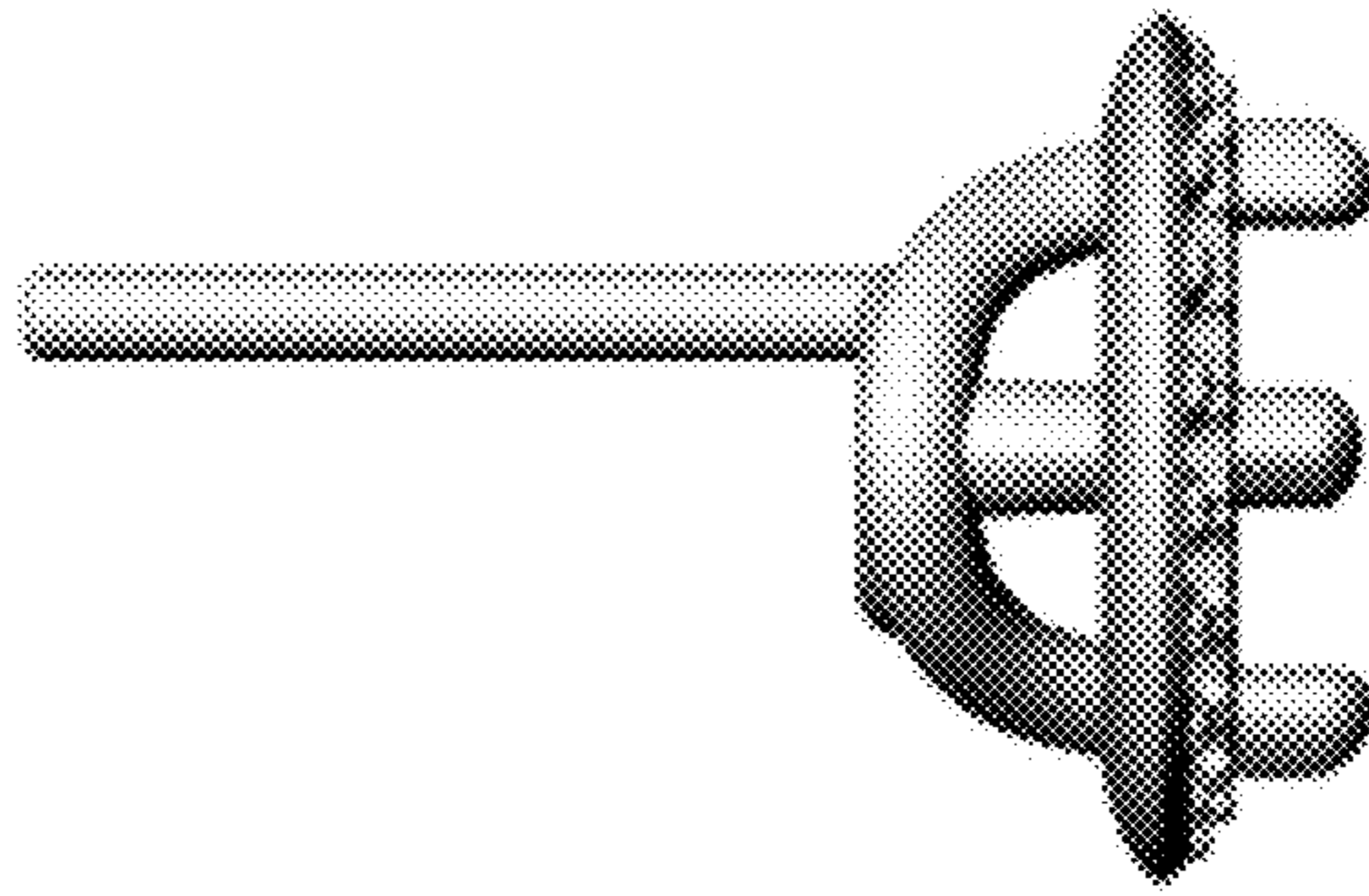

FIG. 4

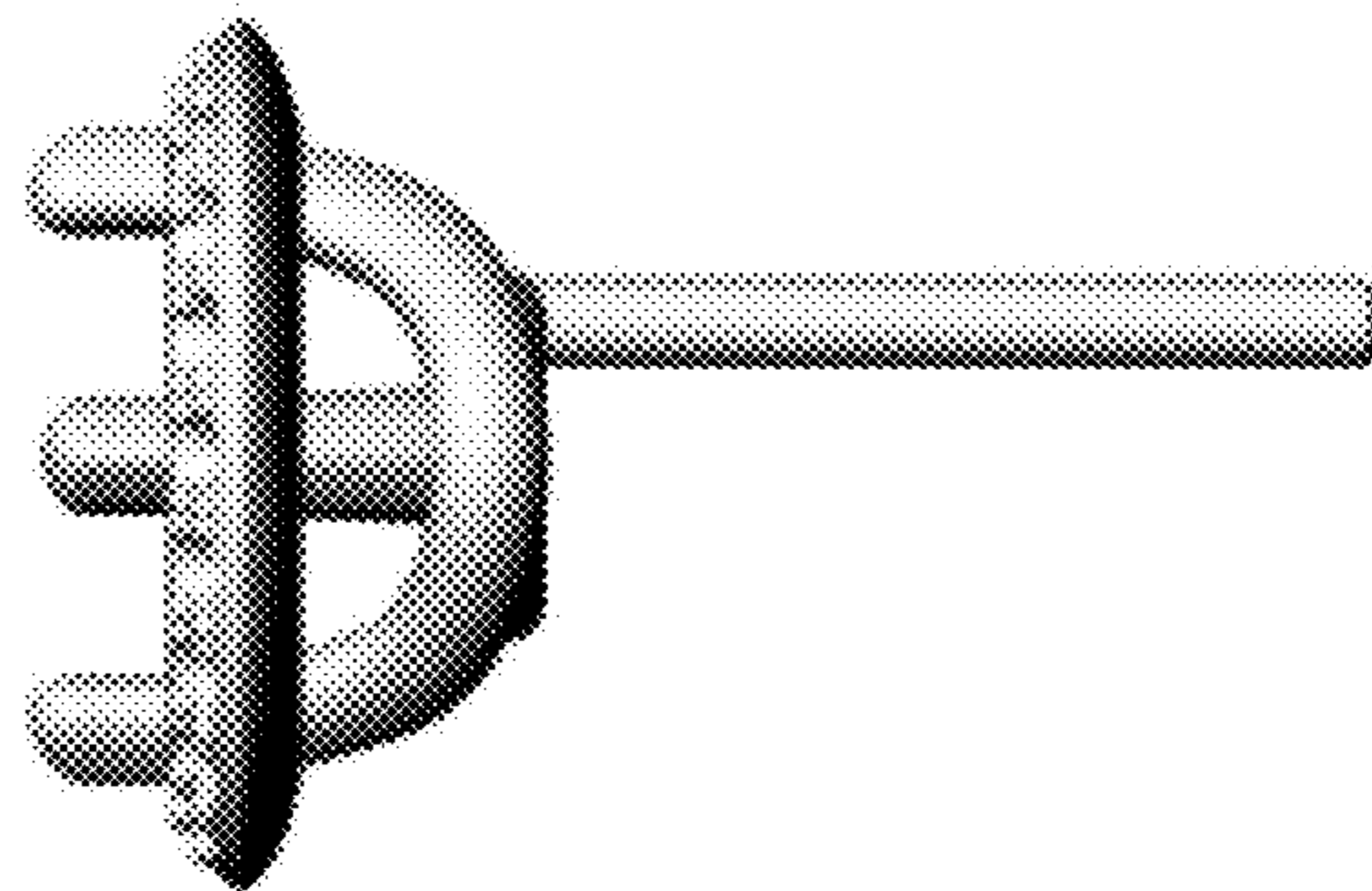

FIG. 5

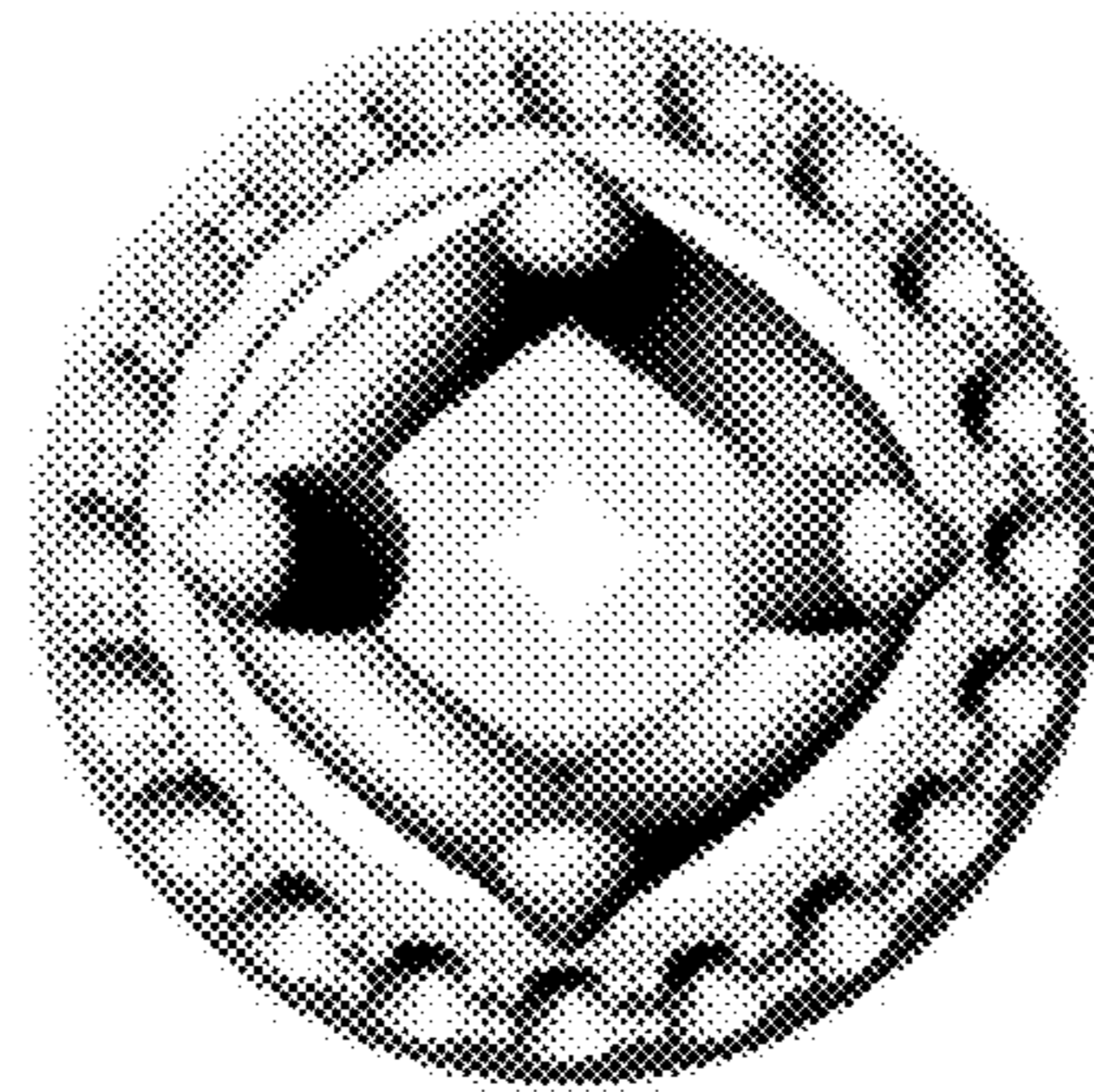

FIG. 6

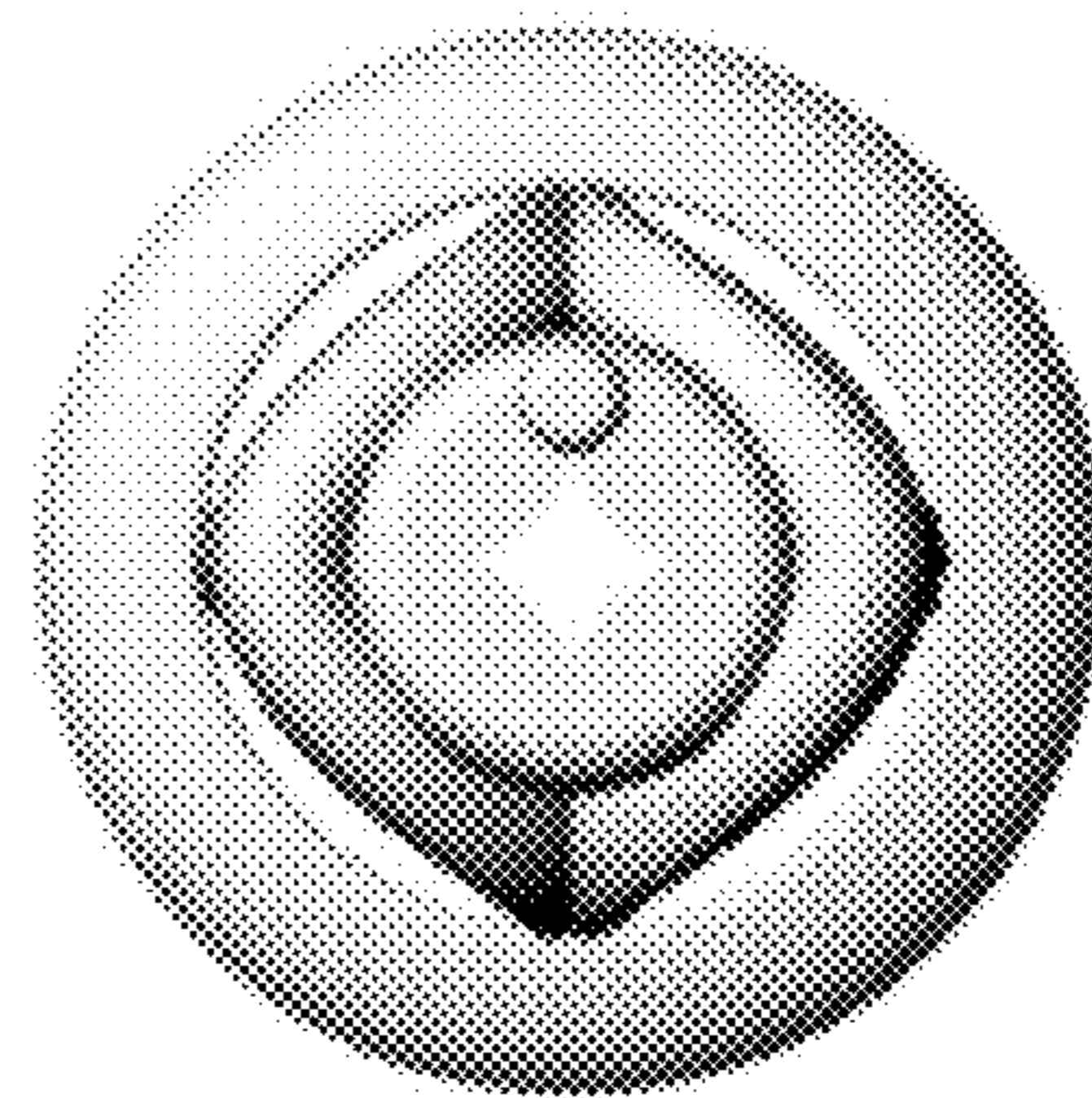

FIG. 7

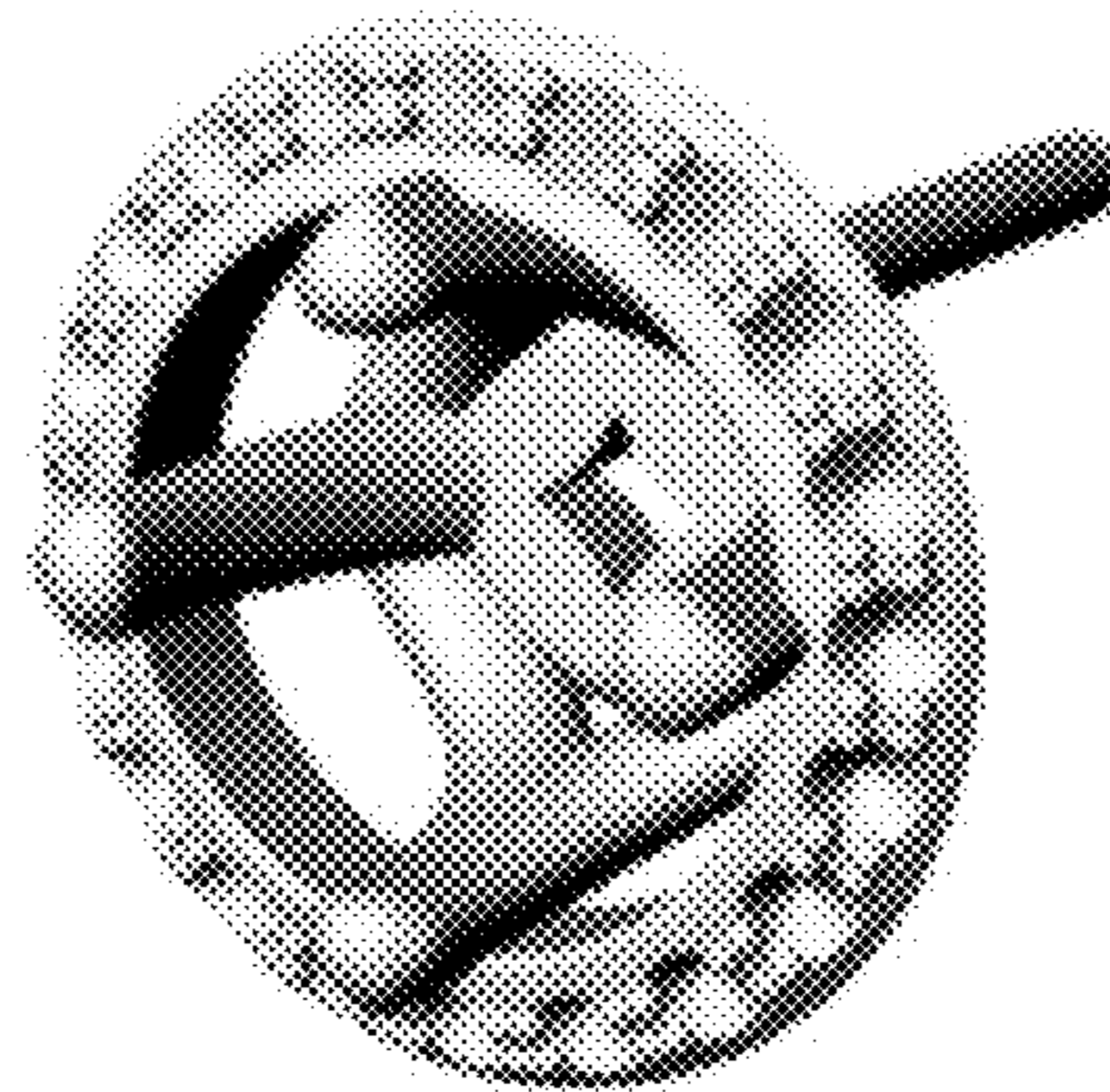

FIG. 8

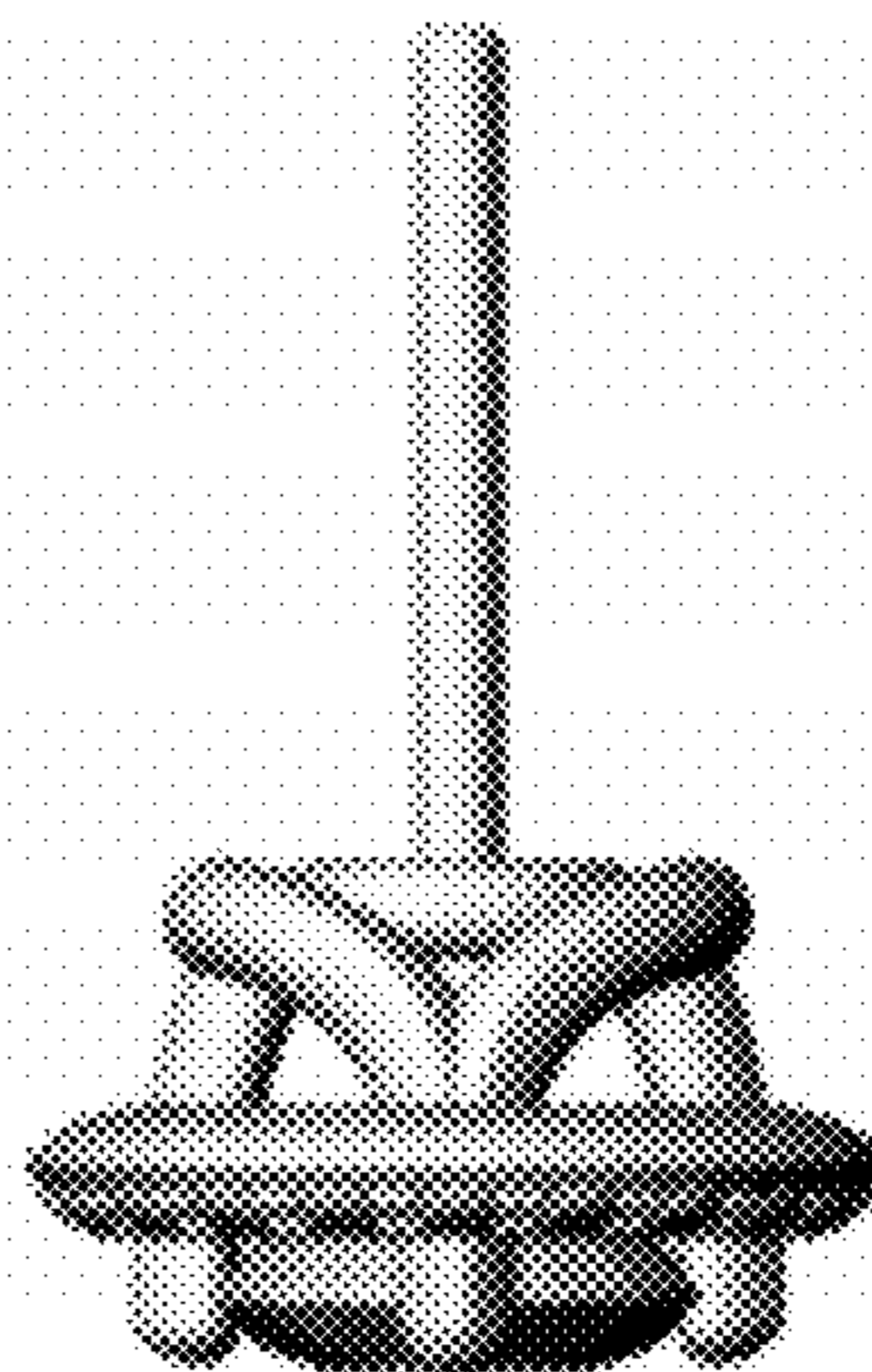

FIG. 9

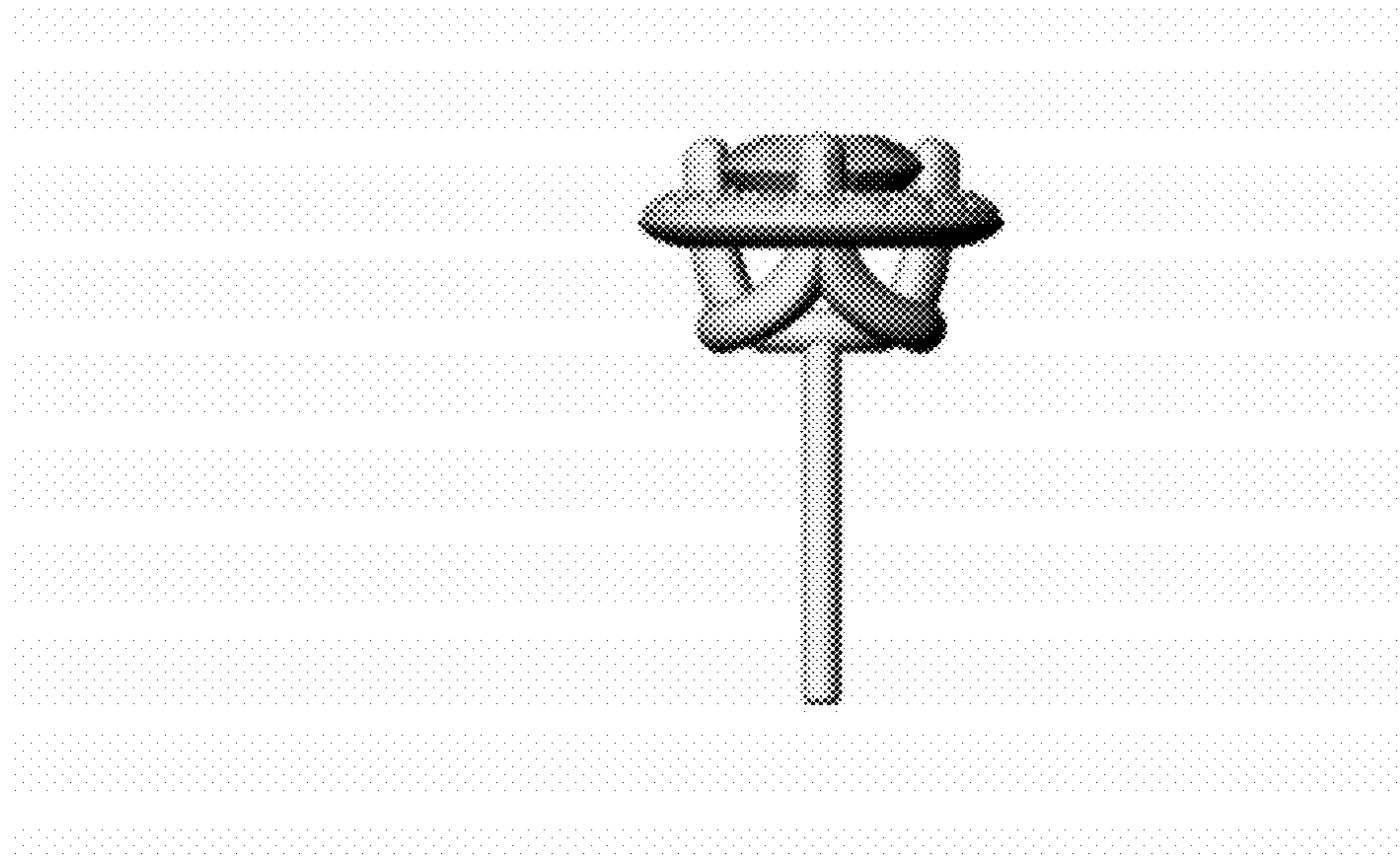

FIG. 10

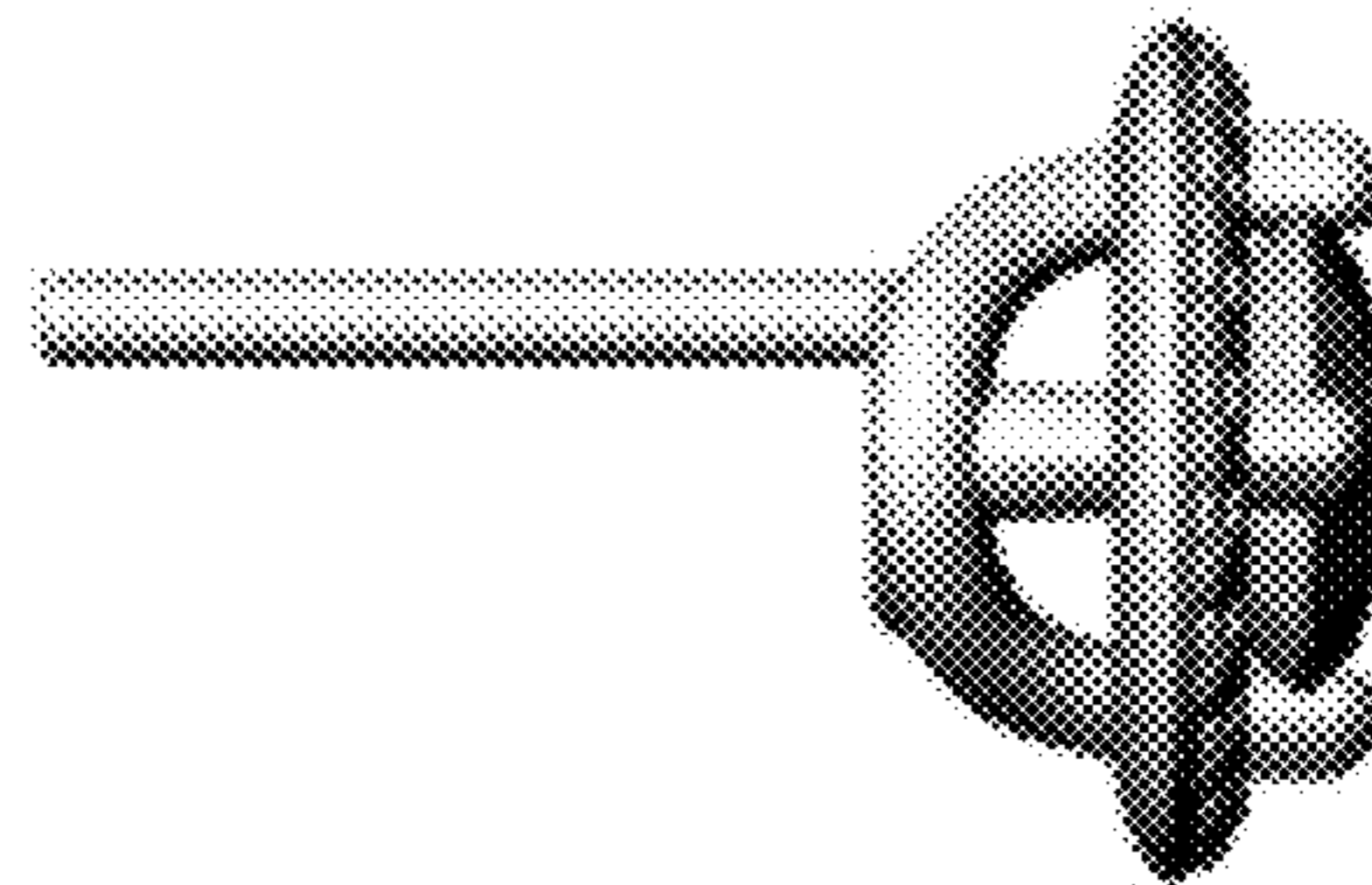

FIG. 11

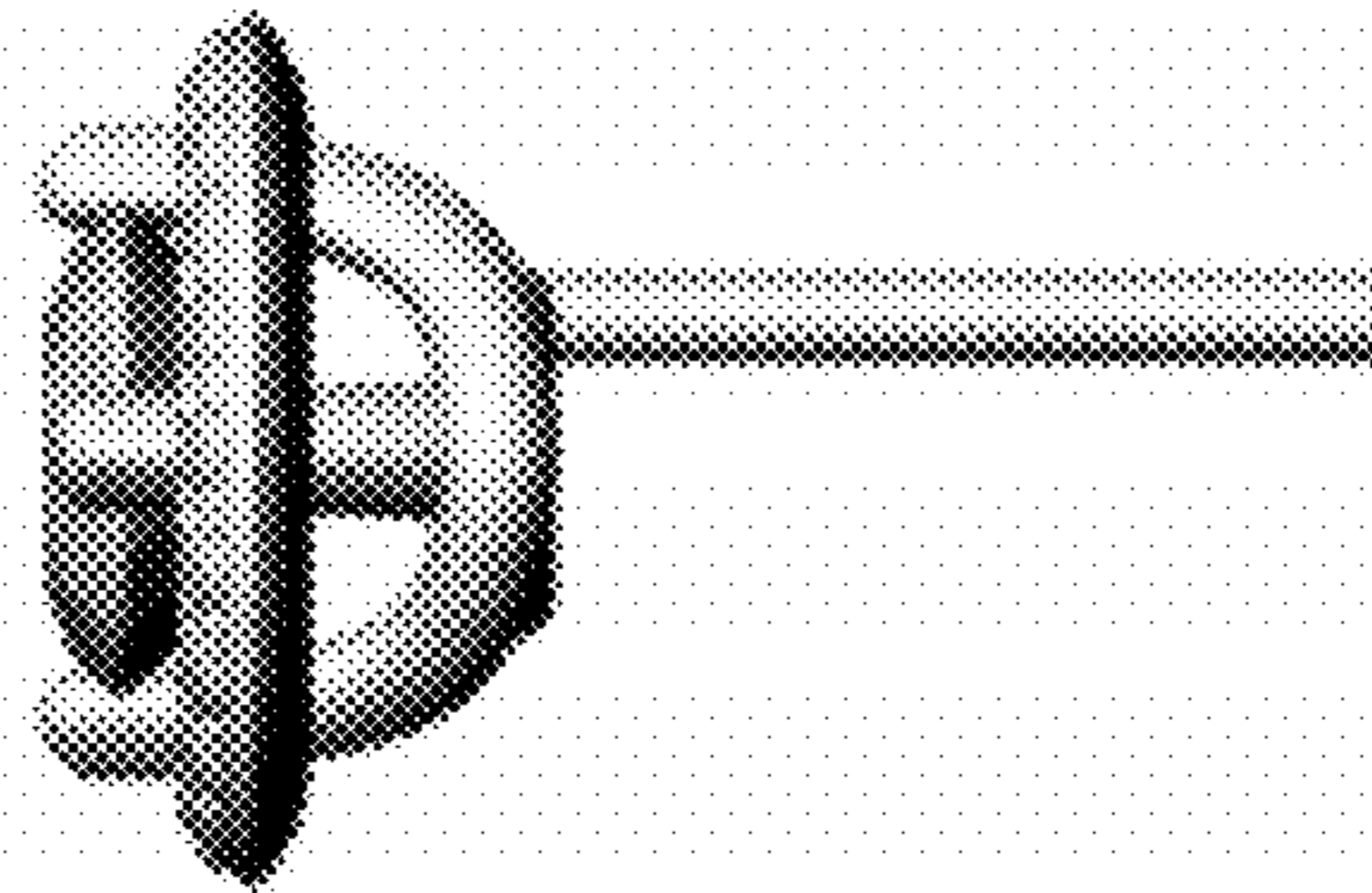

FIG. 12

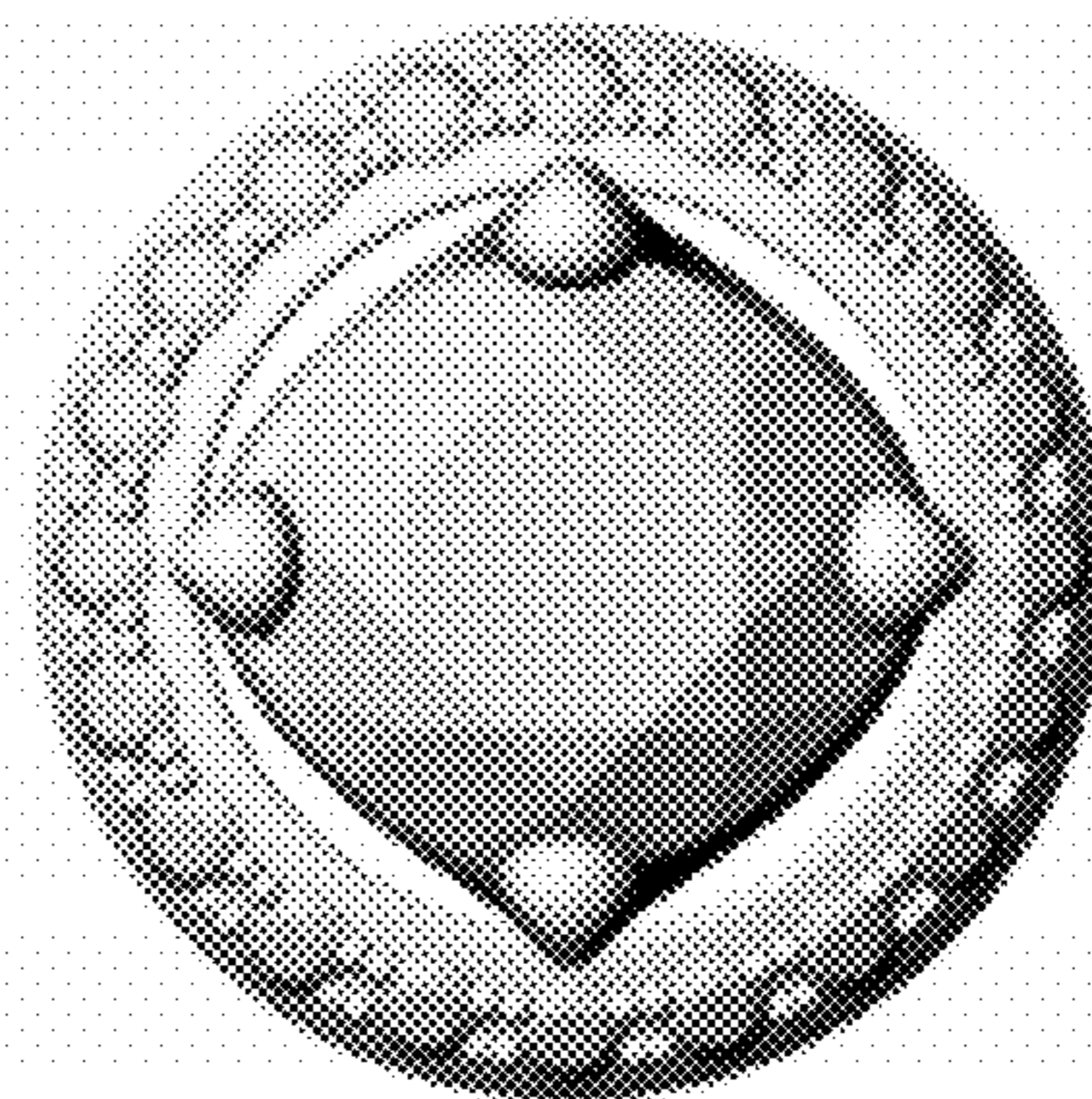

FIG. 13

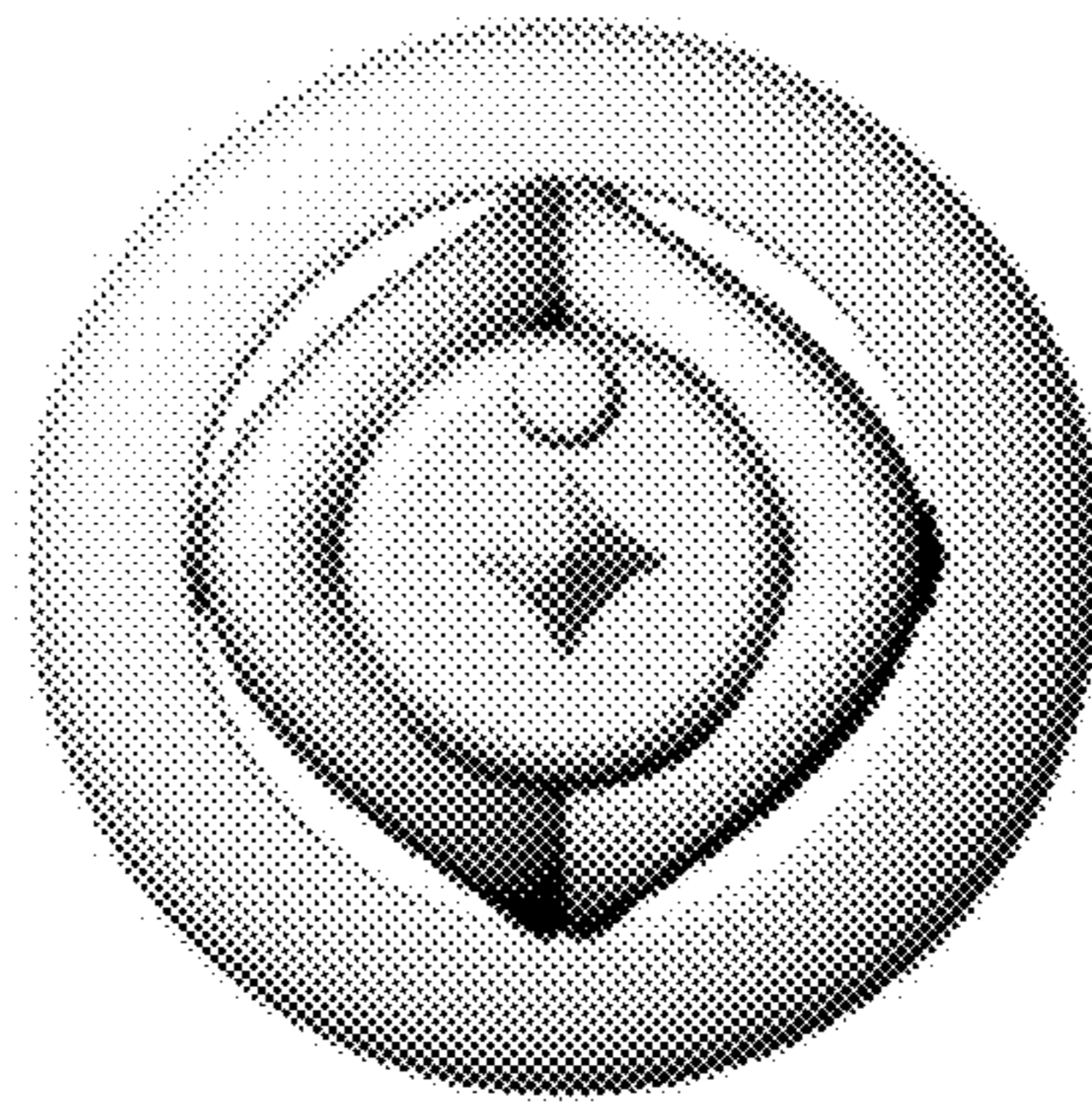

FIG. 14

