



US00D676348S

(12) **United States Design Patent**  
**Papadimitriou**

(10) **Patent No.:** **US D676,348 S**

(45) **Date of Patent:** **\*\* Feb. 19, 2013**

(54) **RING**

(75) Inventor: **Costantino Papadimitriou**, Milan (IT)

(73) Assignee: **De Beers Centenary AG**, Lucerne (CH)

(\*\*) Term: **14 Years**

(21) Appl. No.: **29/420,742**

(22) Filed: **May 11, 2012**

(51) **LOC (9) Cl.** ..... **11-01**

(52) **U.S. Cl.** ..... **D11/34**

(58) **Field of Classification Search** ..... D11/1,  
D11/3, 26-39; 63/26-28, 12-14, 3, 3.1,  
63/3.2, 15, 15.1-15.4, 15.45, 15.5, 15.6,  
63/15.65, 15.7

See application file for complete search history.

(56) **References Cited**

**U.S. PATENT DOCUMENTS**

D386,438 S	11/1997	Itzkowitz	
D415,977 S *	11/1999	Itzkowitz	D11/34
D421,404 S *	3/2000	Canale	D11/26
D454,315 S	3/2002	Ambar	
D506,405 S	6/2005	Fortgang	
D508,866 S *	8/2005	Shin	D11/34
D525,556 S *	7/2006	Sandberg	D11/34
D602,807 S	10/2009	Colombani et al.	
D614,066 S *	4/2010	Vagal	D11/34
D614,067 S *	4/2010	Vagal	D11/34
D634,667 S	3/2011	Papadimitriou	
D636,694 S *	4/2011	Papadimitriou	D11/34
D636,695 S *	4/2011	Papadimitriou	D11/34
D637,101 S *	5/2011	Papadimitriou	D11/34
D637,102 S *	5/2011	Papadimitriou	D11/35
D660,742 S *	5/2012	Papadimitriou	D11/34
D661,218 S *	6/2012	Papadimitriou	D11/34

**OTHER PUBLICATIONS**

Diamond Ring, issued Jul. 1, 2009, owned by Jesper Revsbaek Veiling of Maidstone, Kent.

Jewellery, issued Aug. 5, 2011, owned by WB The Creative Jewellery Group Limited of Birmingham, West Midlands.

\* cited by examiner

*Primary Examiner* — Cathron Brooks

*Assistant Examiner* — Melanie Pellegrini

(74) *Attorney, Agent, or Firm* — SNR Denton US LLP; Brian R. McGinley

(57) **CLAIM**

The ornamental design for a ring, as shown and described.

**DESCRIPTION**

FIG. 1 is a top view of a ring illustrating the new design; FIG. 2 is a bottom view of the ring illustrated in FIG. 1; FIG. 3 is a left side elevational view of the ring illustrated in FIG. 1; FIG. 4 is a right side elevational view of the ring illustrated in FIG. 1; FIG. 5 is a front view of the ring shown in FIG. 1; FIG. 6 is a rear view of the ring illustrated in FIG. 1; FIG. 7 is a perspective view of the ring illustrated in FIG. 1; FIG. 8 is a top view of a second embodiment of the ring; FIG. 9 is a bottom view of the ring illustrated in FIG. 8; FIG. 10 is a left side elevational view of the ring illustrated in FIG. 8; FIG. 11 is a right side elevational view of the ring illustrated in FIG. 8; FIG. 12 is a front view of the ring shown in FIG. 8; FIG. 13 is a rear view of the ring illustrated in FIG. 8; FIG. 14 is a perspective view of the ring illustrated in FIG. 8; FIG. 15 is a top view of a third embodiment of the ring; FIG. 16 is a bottom view of the ring illustrated in FIG. 15; FIG. 17 is a left side elevational view of the ring illustrated in FIG. 15; FIG. 18 is a right side elevational view of the ring illustrated in FIG. 15; FIG. 19 is a front view of the ring shown in FIG. 15; FIG. 20 is a rear view of the ring illustrated in FIG. 15; FIG. 21 is a perspective view of the ring illustrated in FIG. 15; FIG. 22 is a top view of a fourth embodiment of the ring; FIG. 23 is a bottom view of the ring illustrated in FIG. 22; FIG. 24 is a left side elevational view of the ring illustrated in FIG. 22; FIG. 25 is a right side elevational view of the ring illustrated in FIG. 22; FIG. 26 is a front view of the ring shown in FIG. 22; FIG. 27 is a rear view of the ring illustrated in FIG. 22; and, FIG. 28 is a perspective view of the ring illustrated in FIG. 22.

**1 Claim, 14 Drawing Sheets**

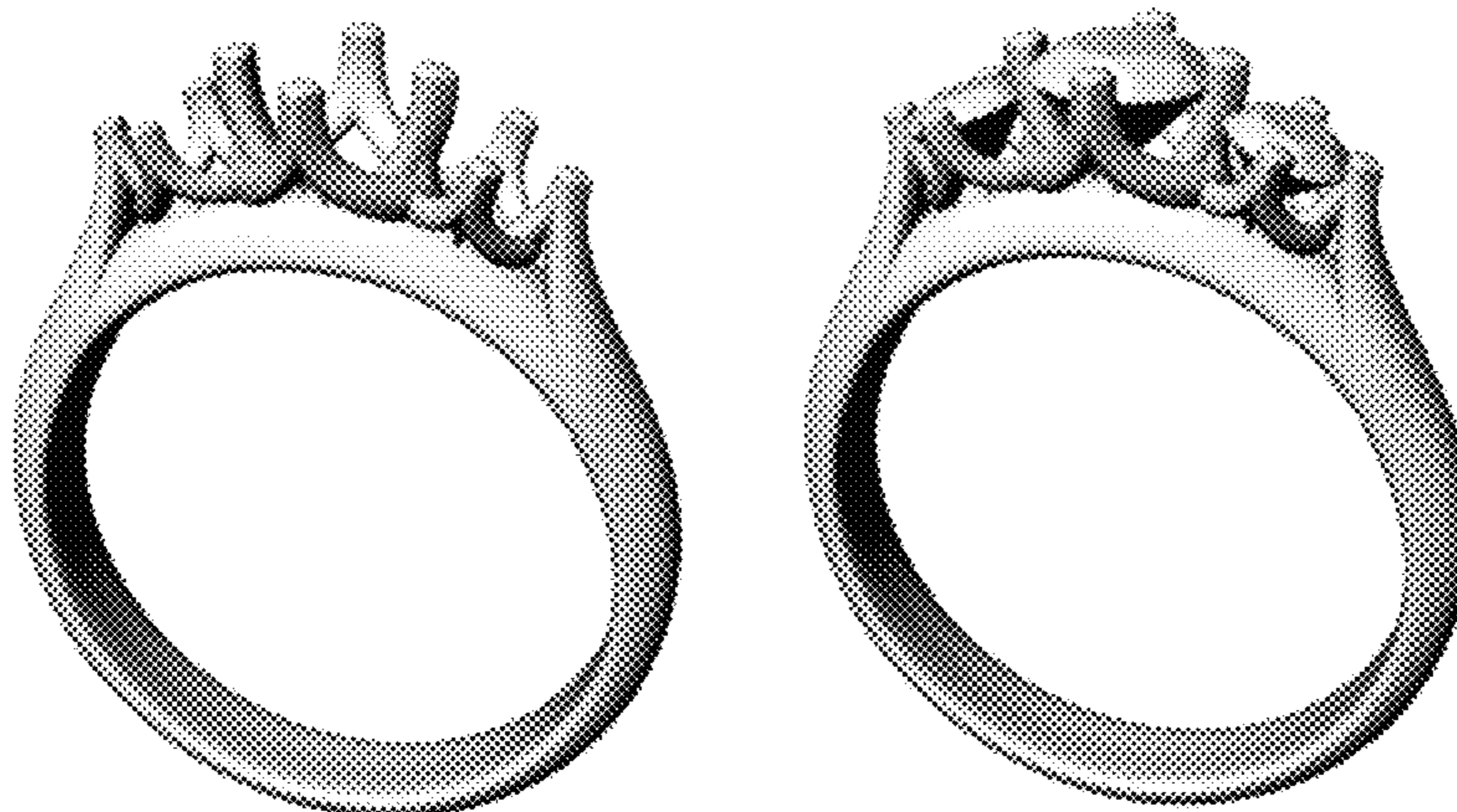

FIG. 1

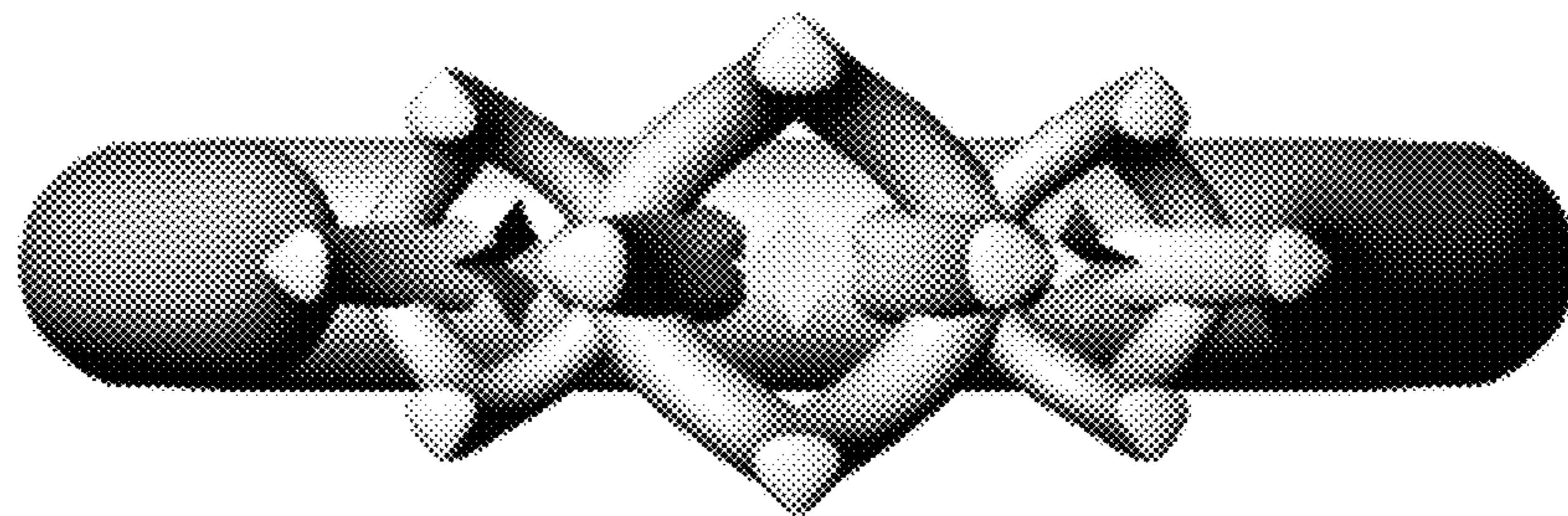

FIG. 2

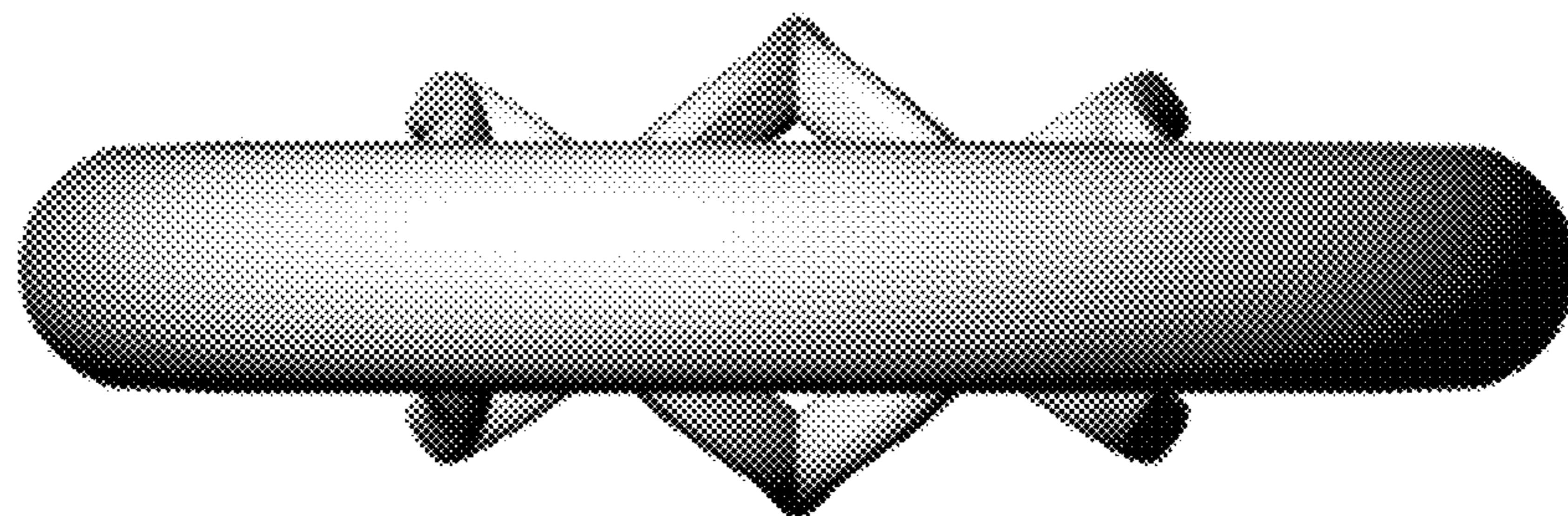

FIG. 3

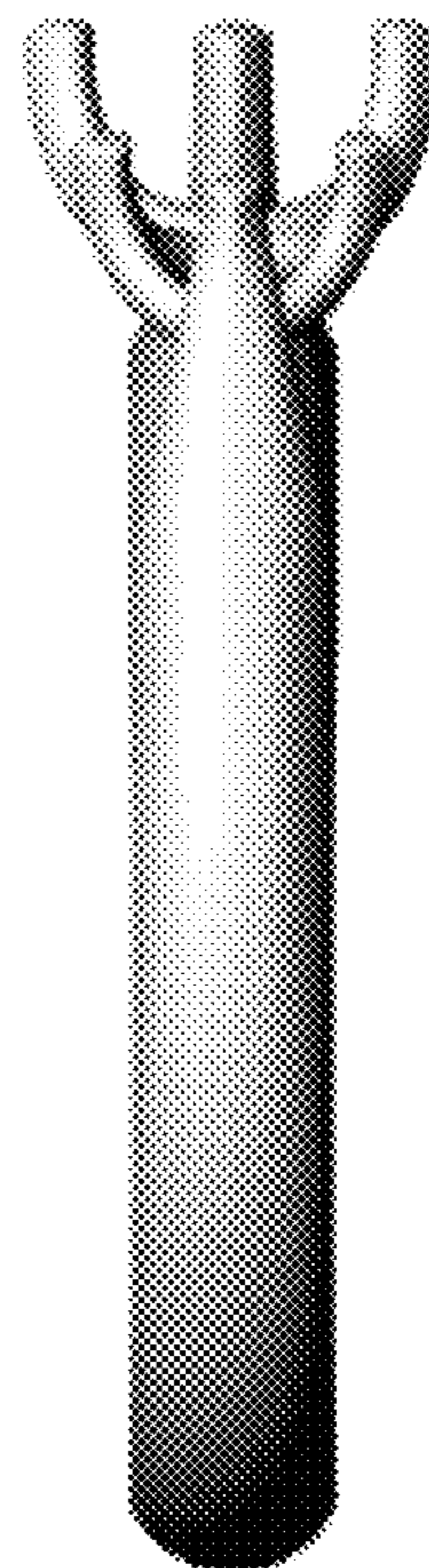

FIG. 4

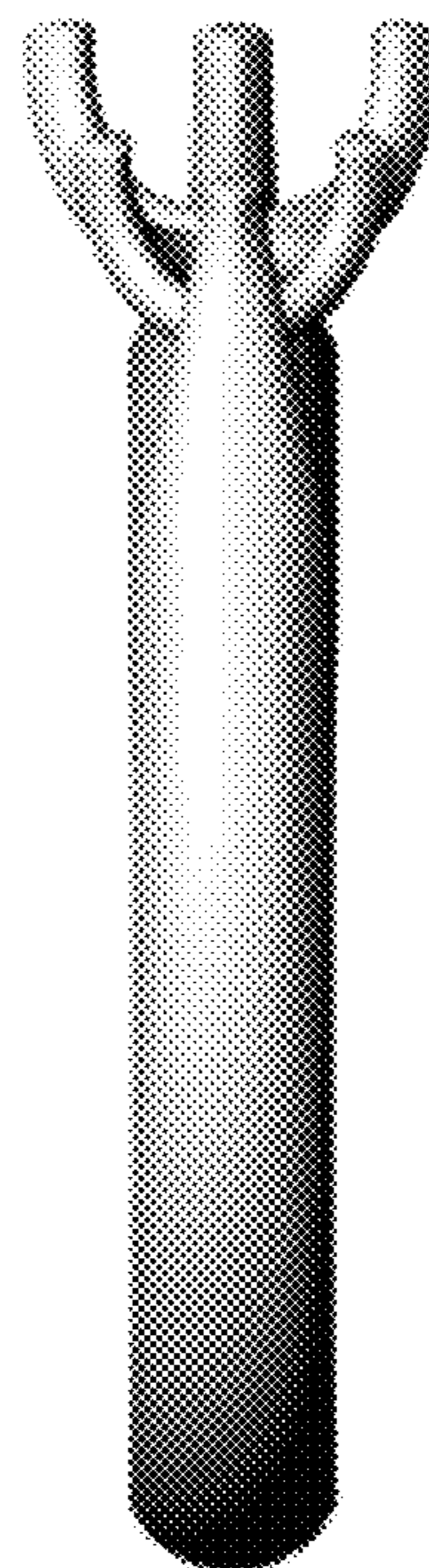

FIG. 5

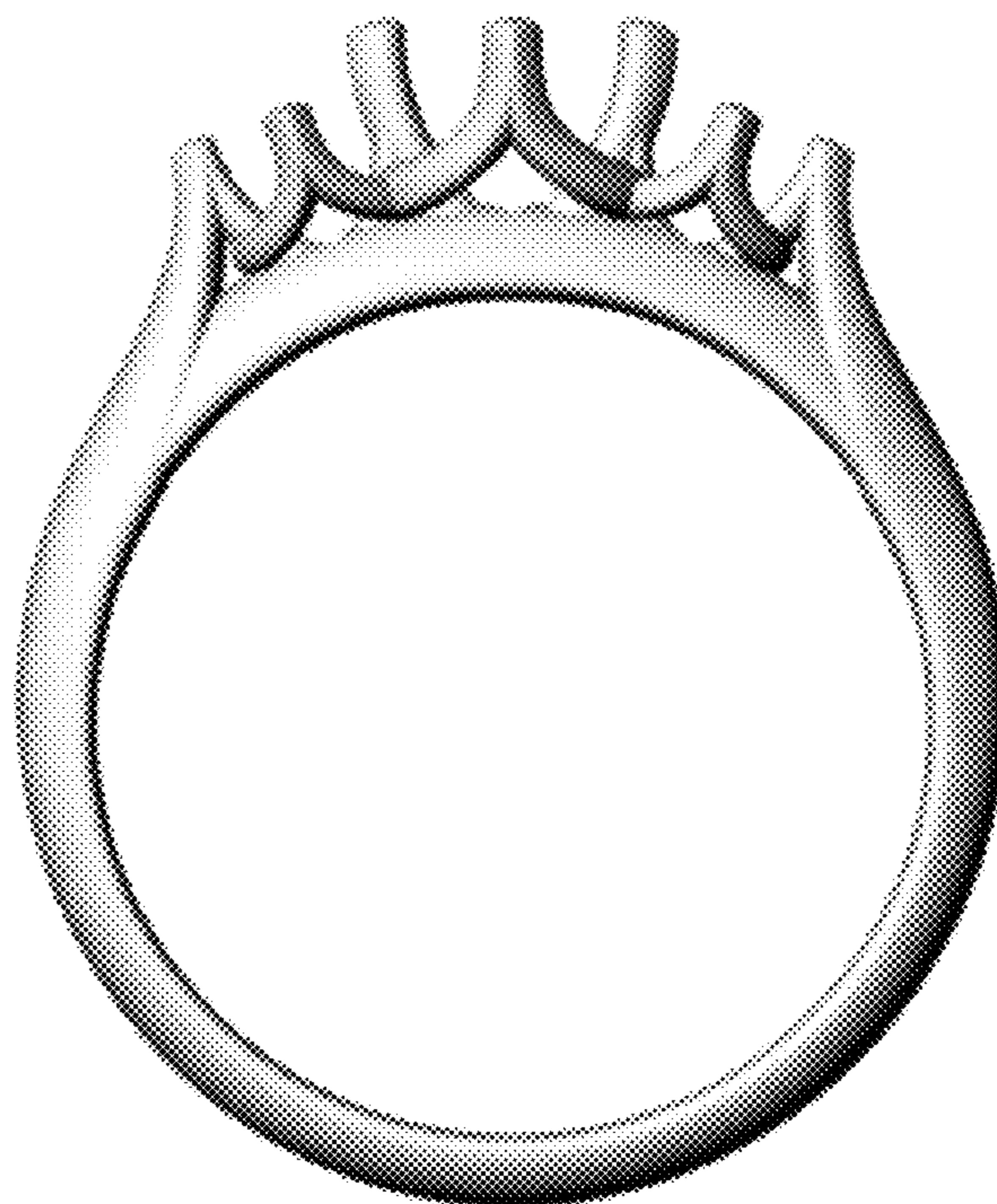

FIG. 6

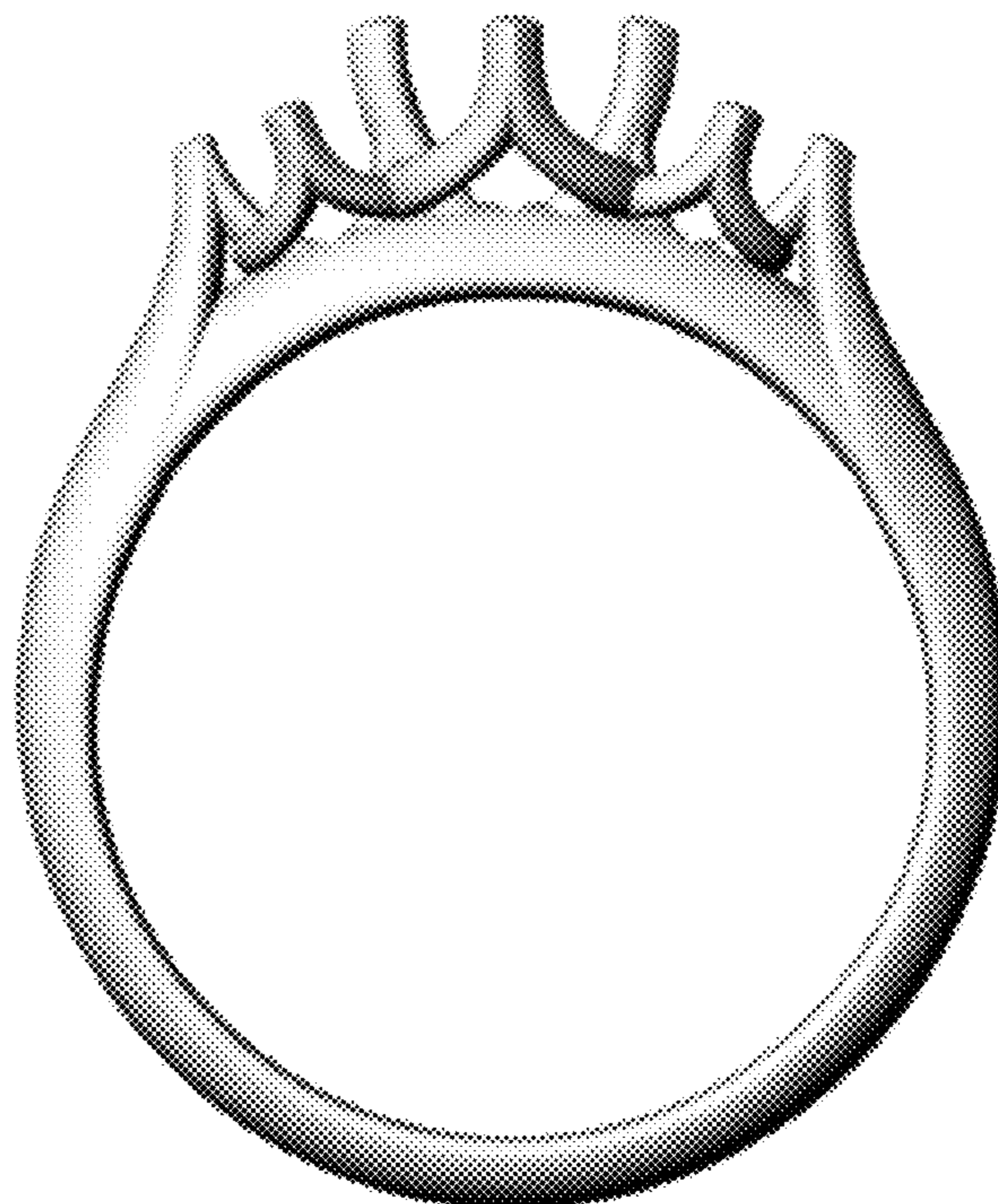

FIG. 7

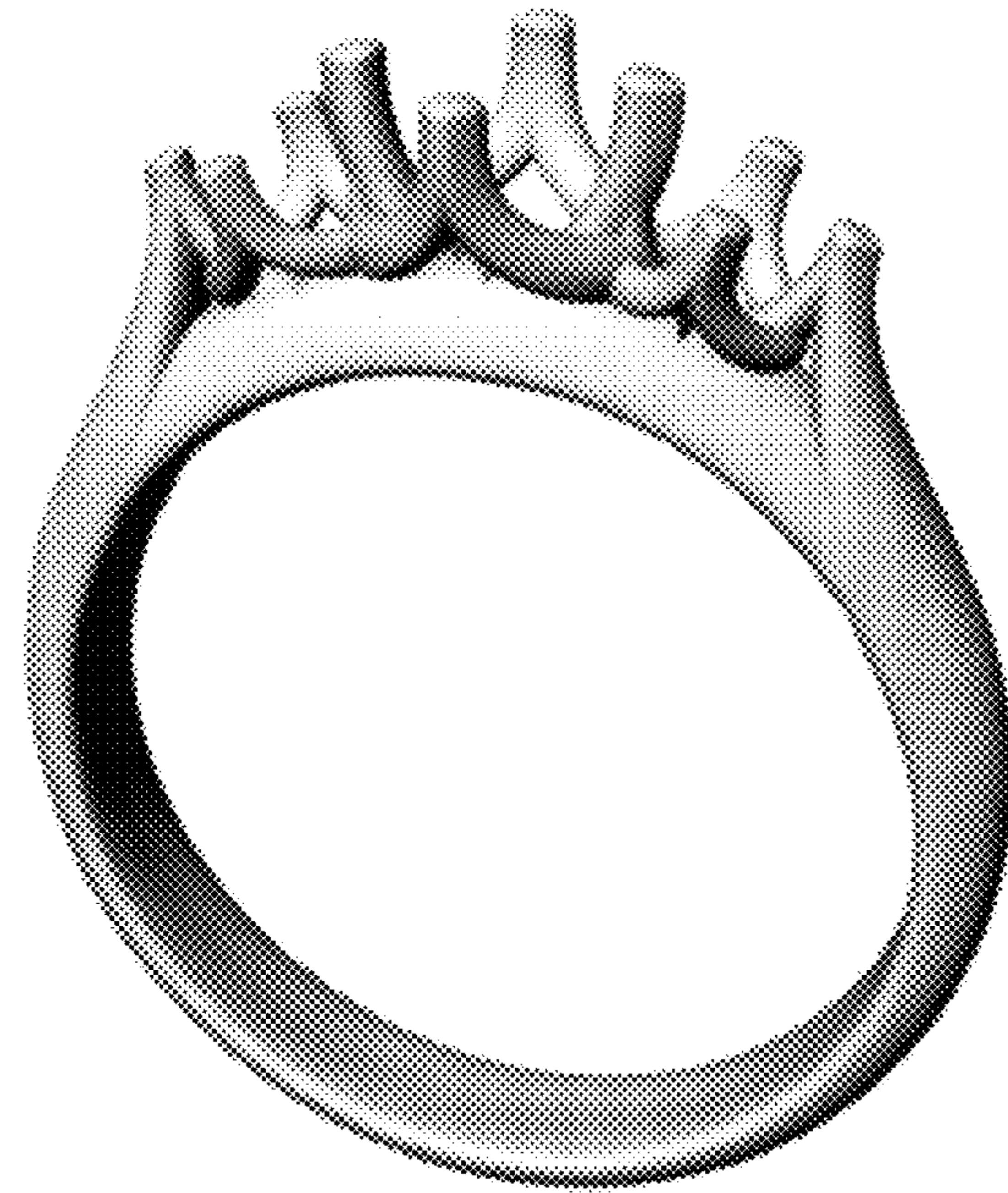

FIG. 8

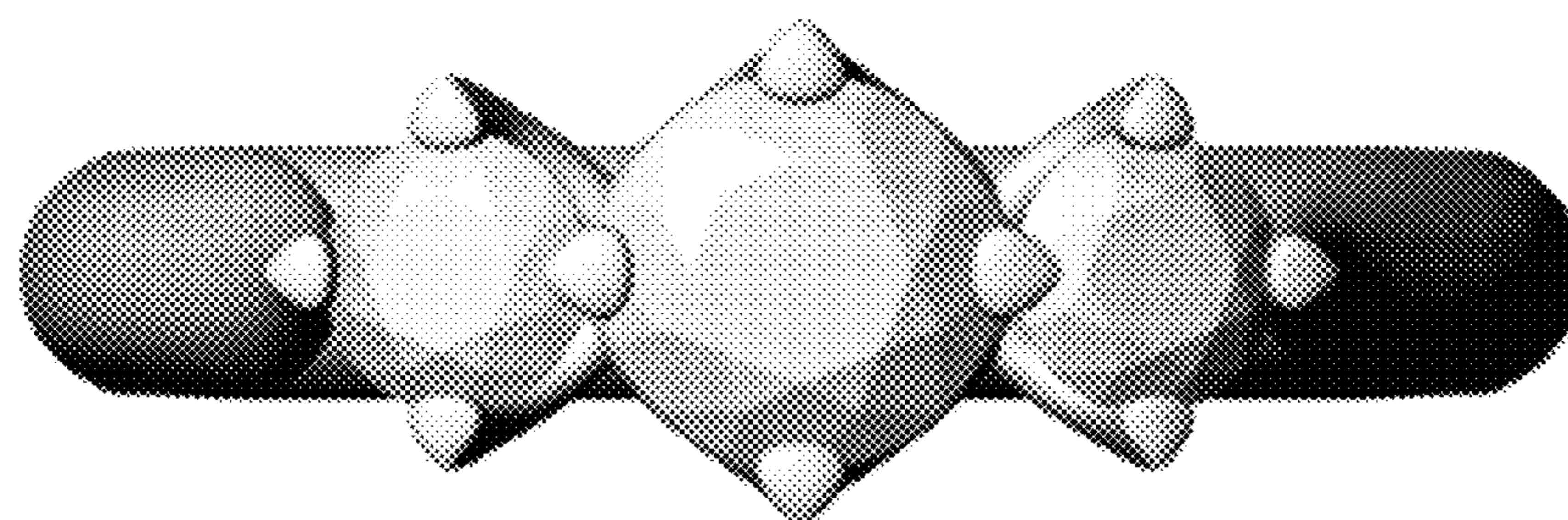

FIG. 9

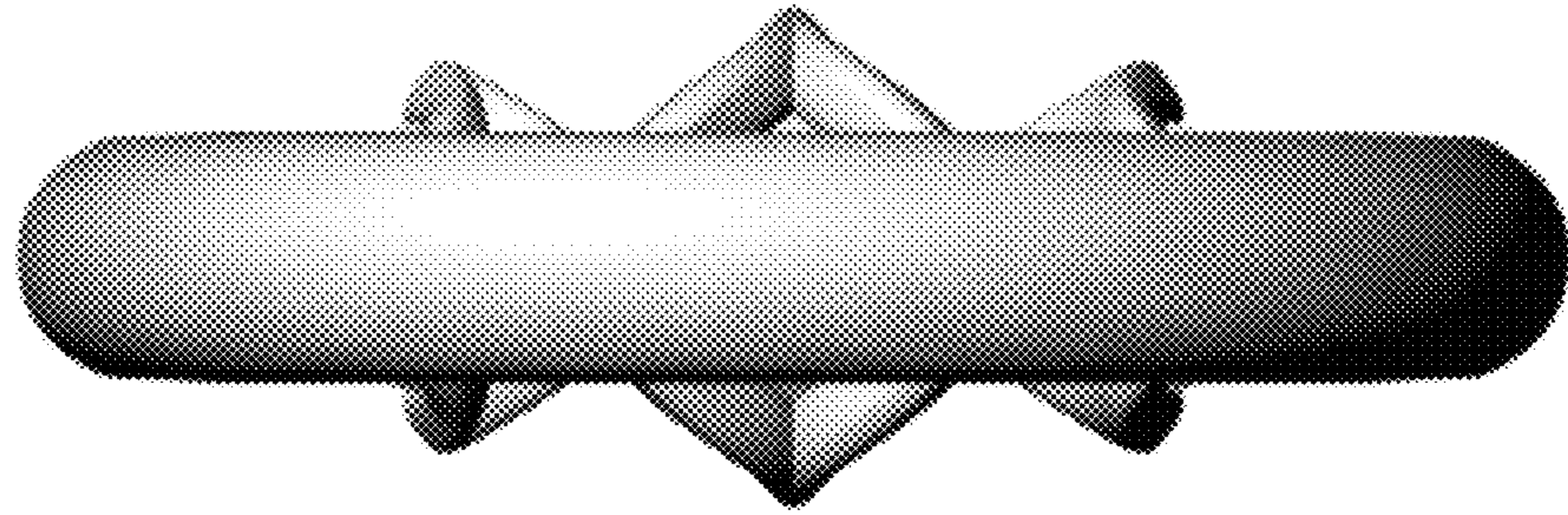

FIG. 10

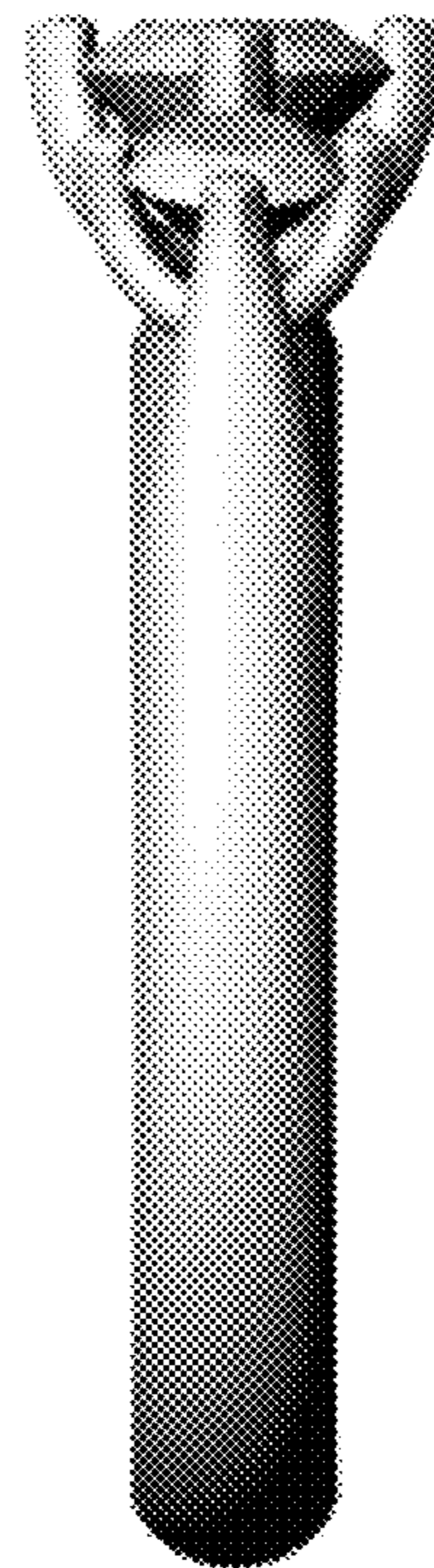

FIG. 11

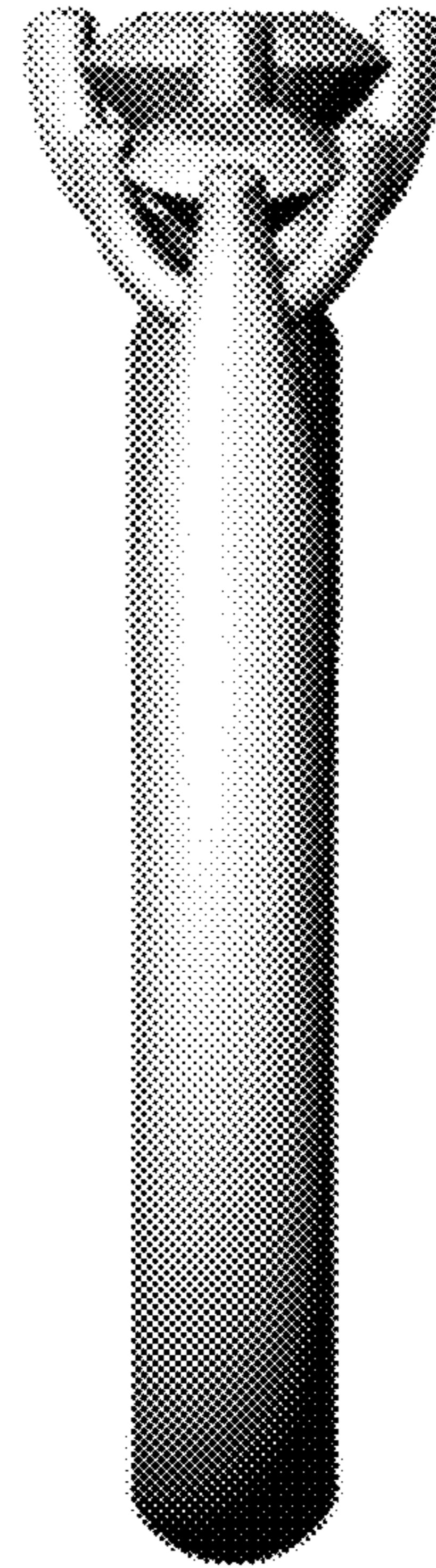

FIG. 12



FIG. 13



FIG. 14

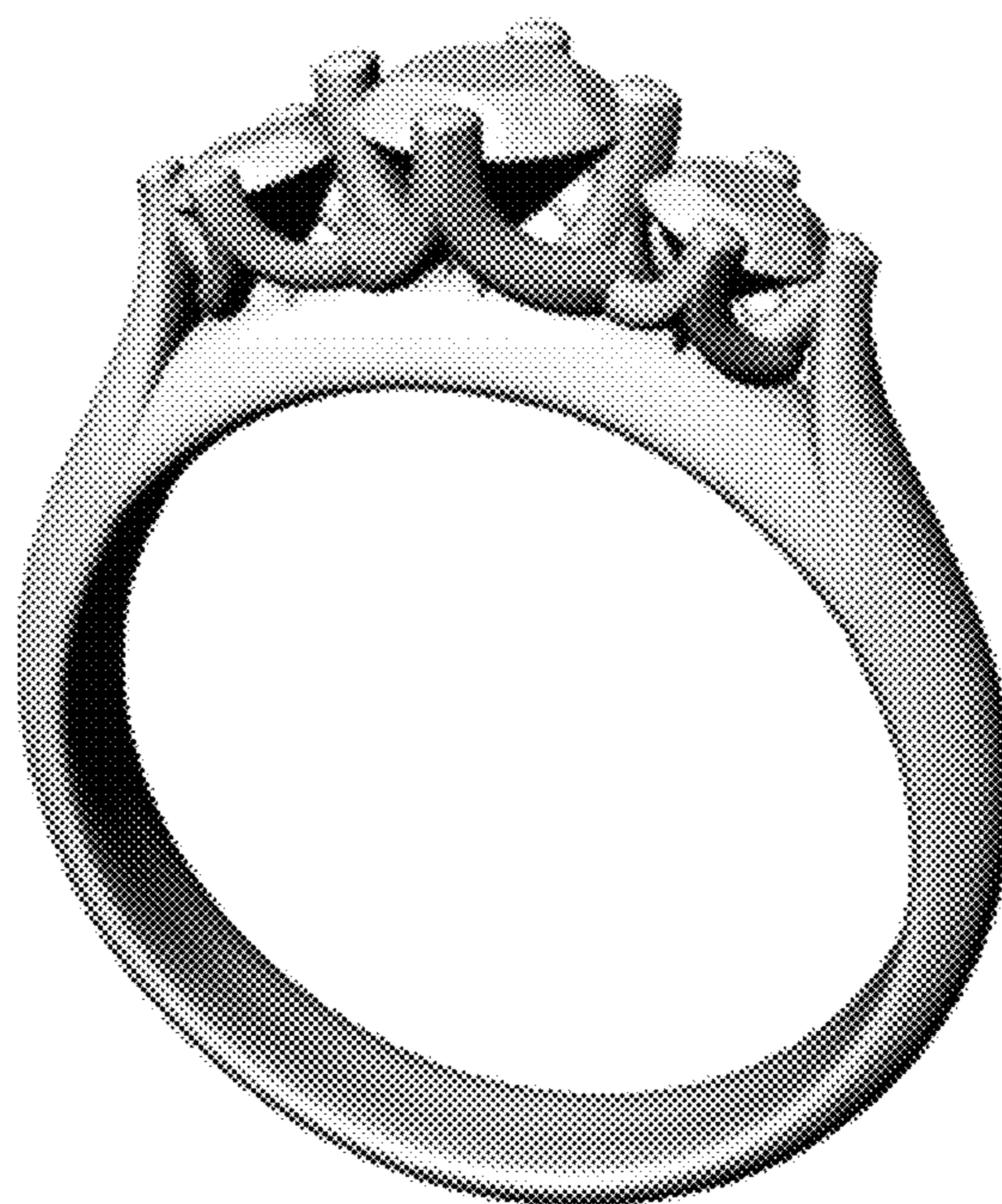



FIG. 15

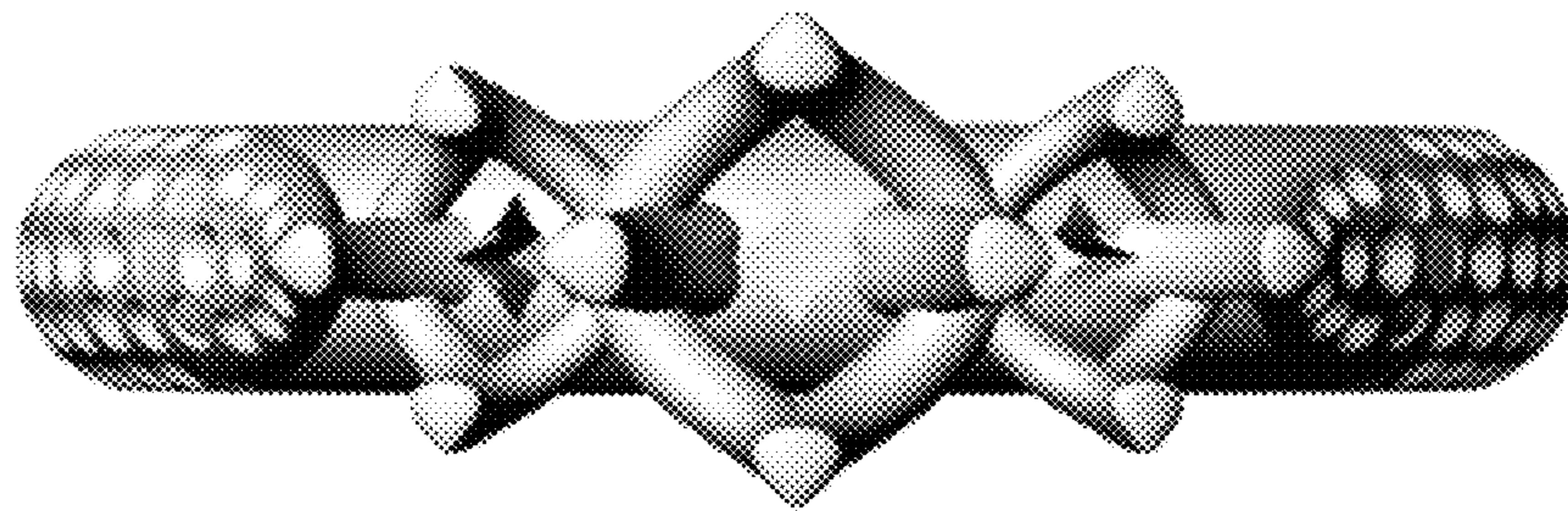

FIG. 16

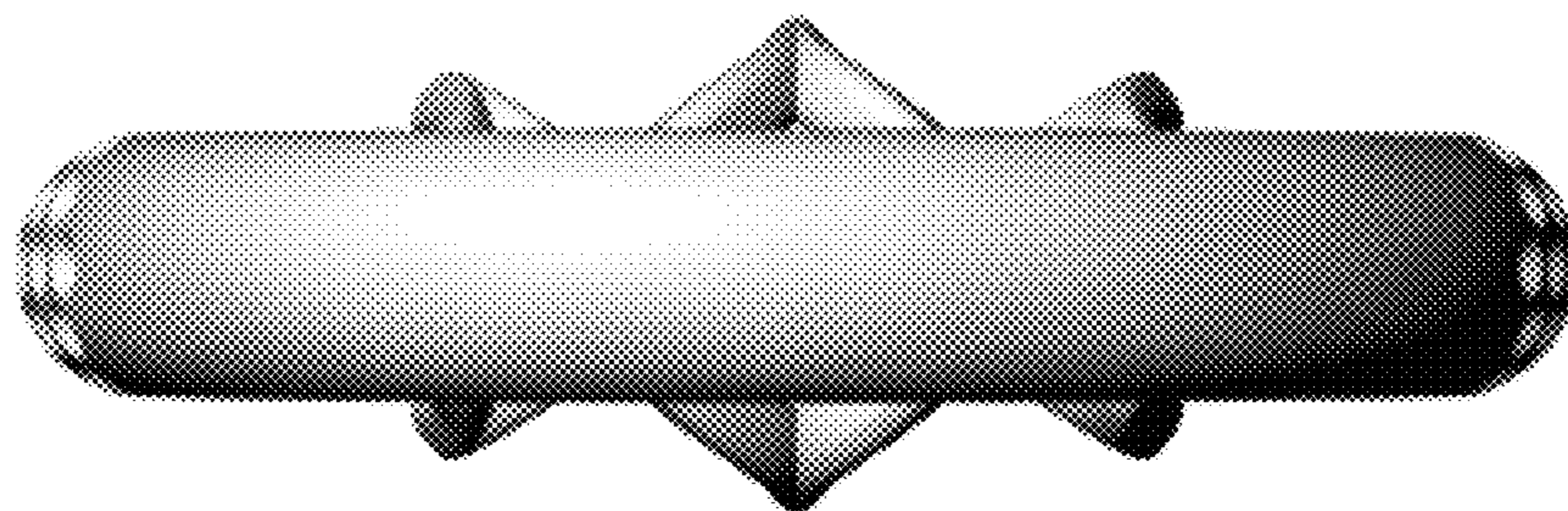

FIG. 17

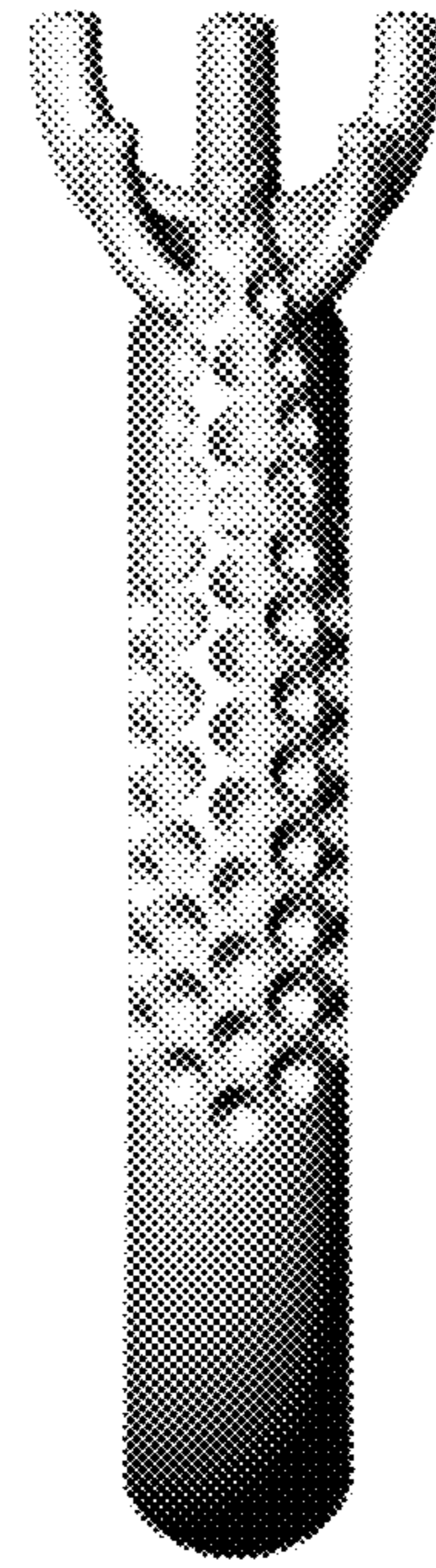

FIG. 18

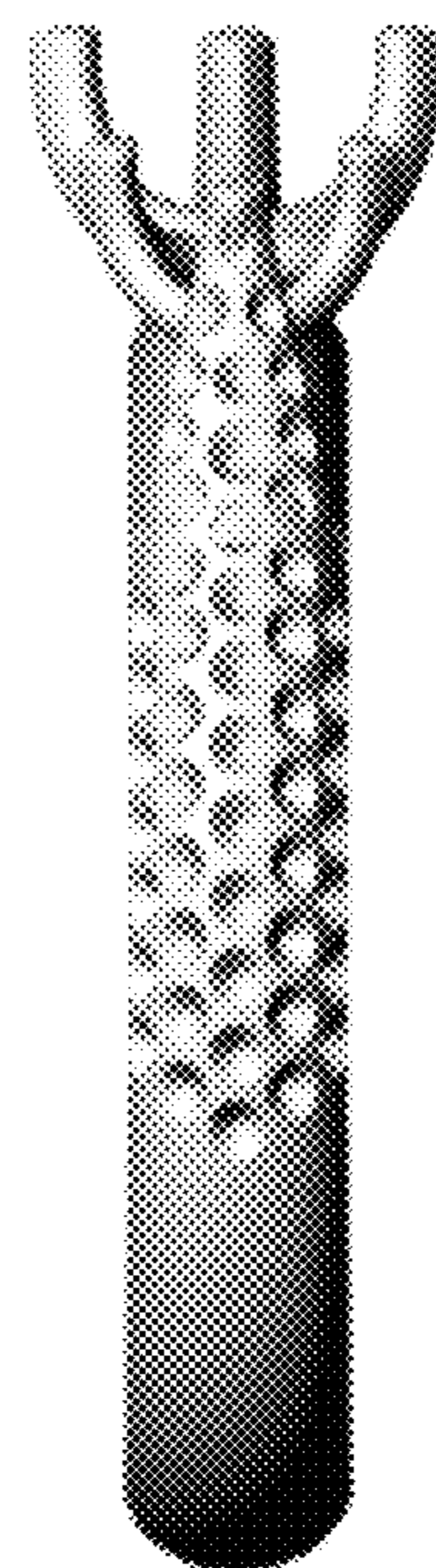

FIG. 19

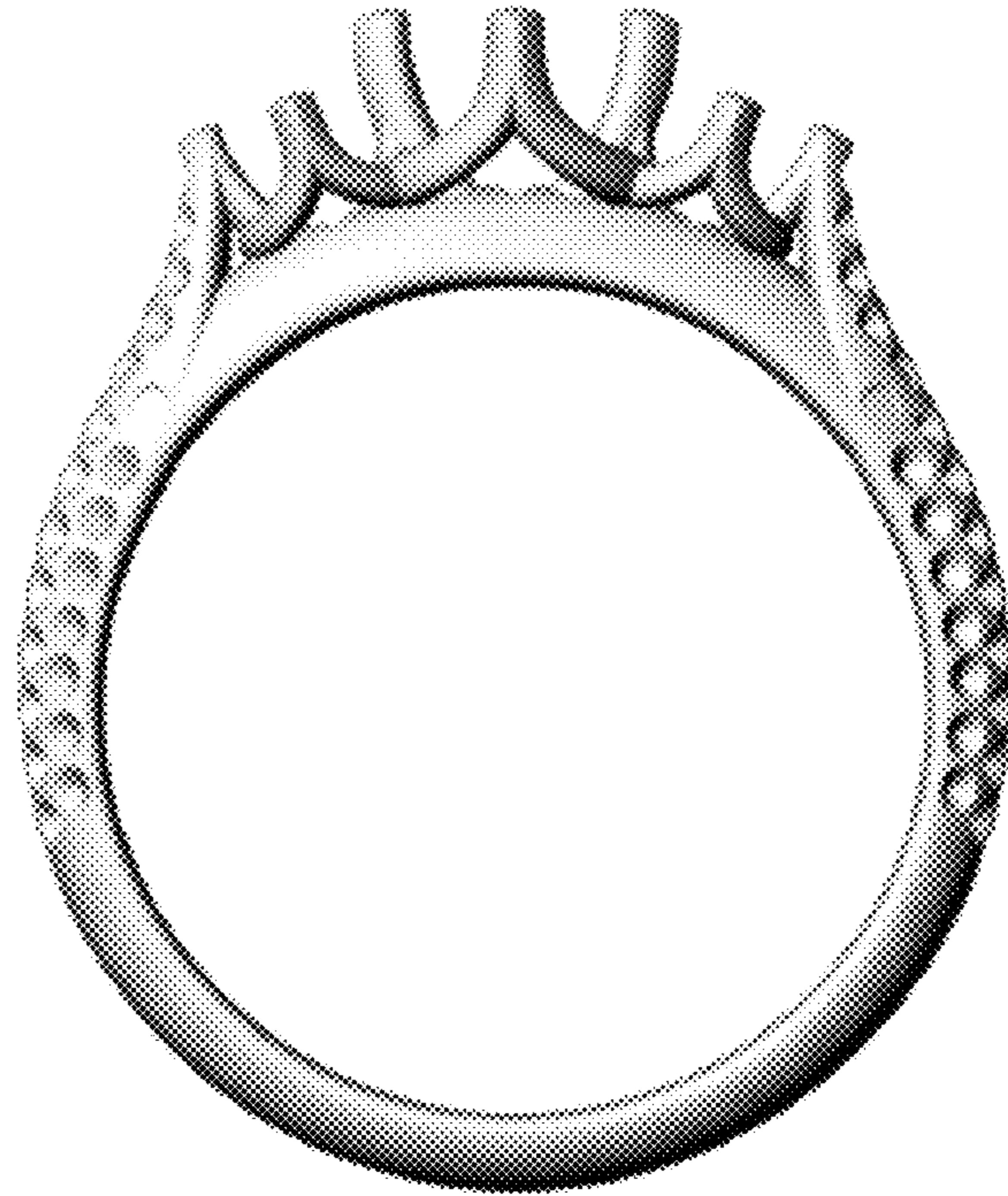

FIG. 20

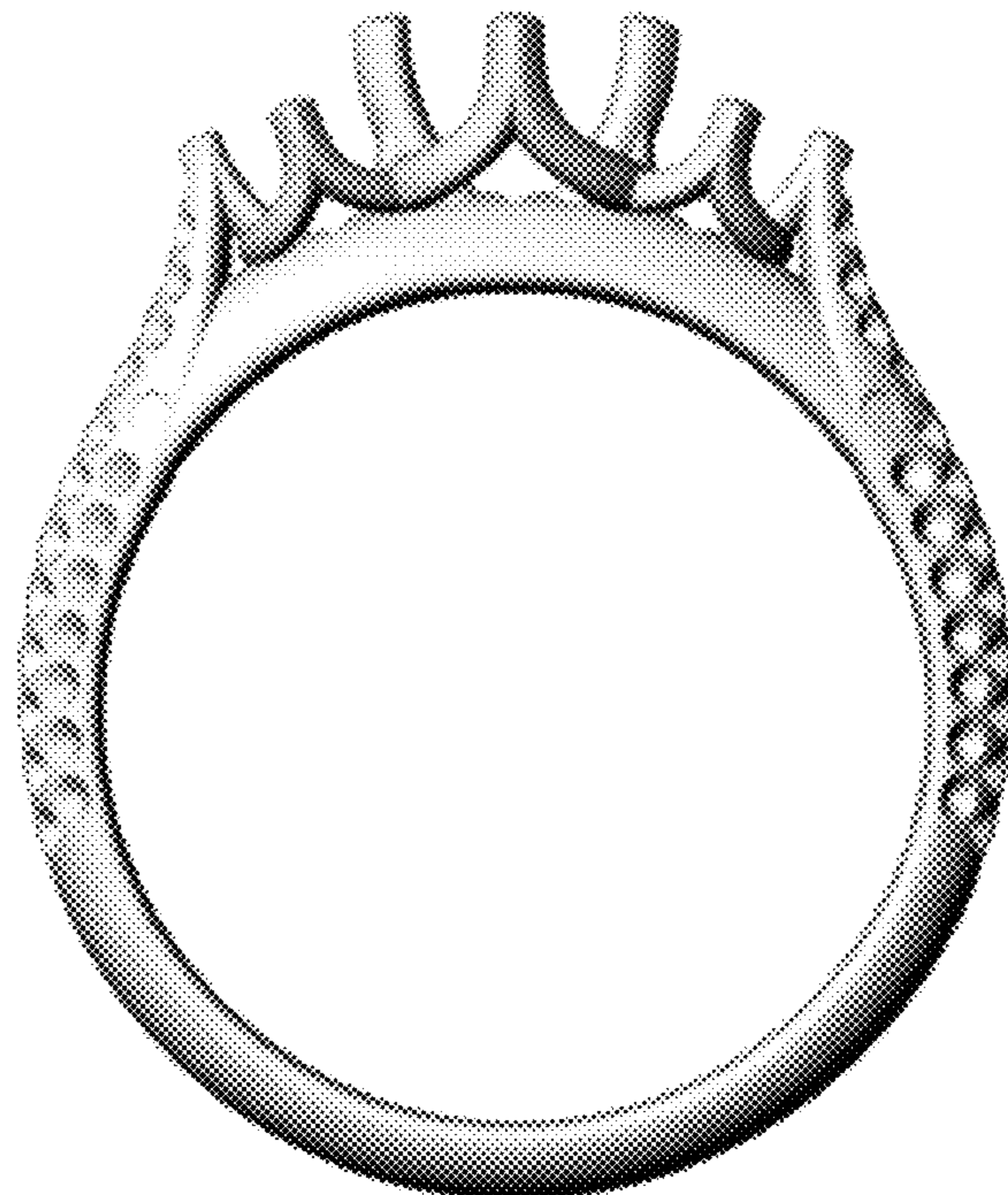

FIG. 21

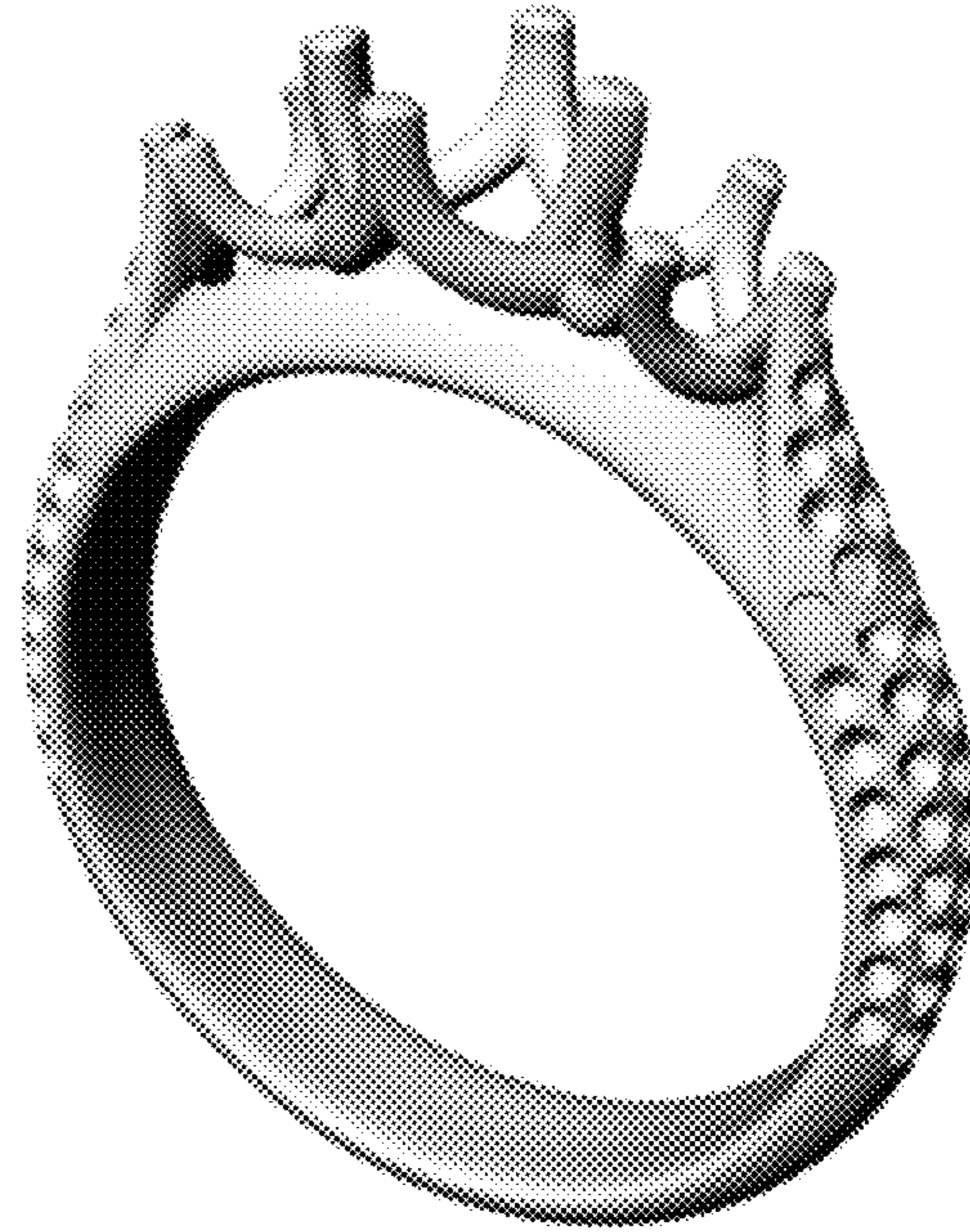

FIG. 22

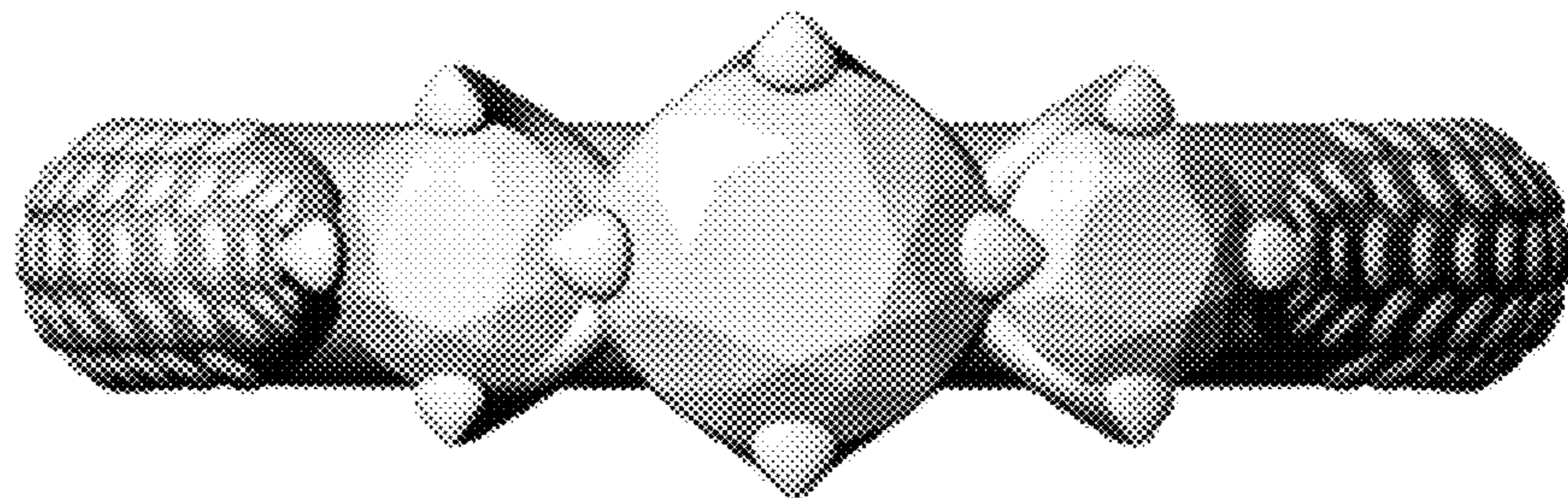

FIG. 23

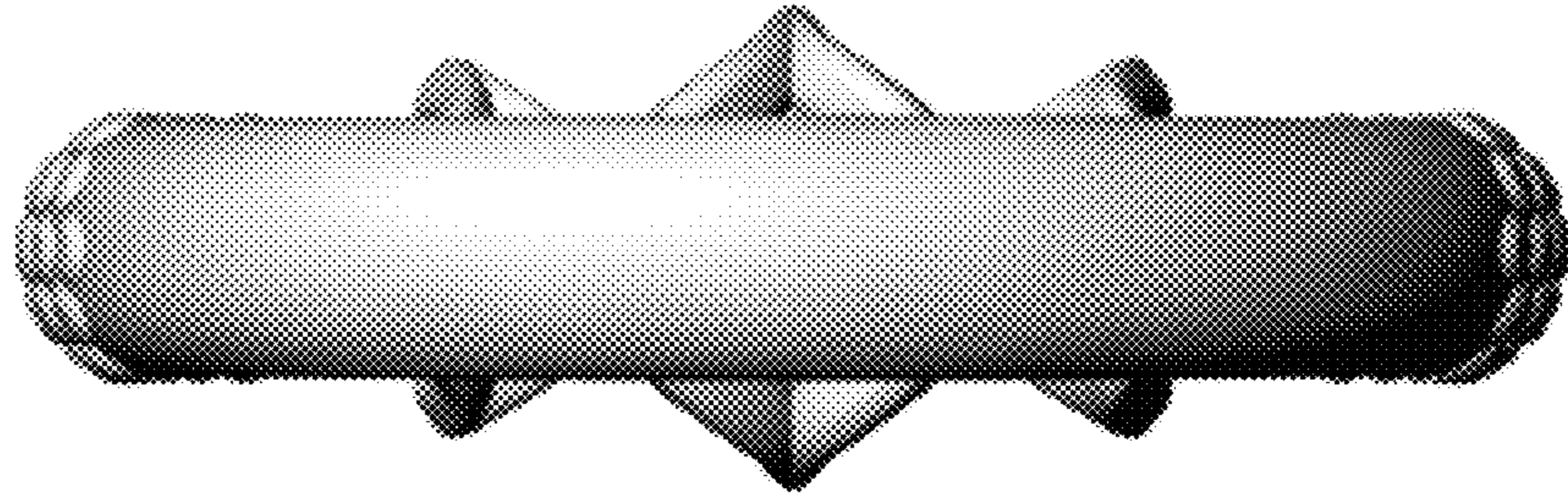

FIG. 24

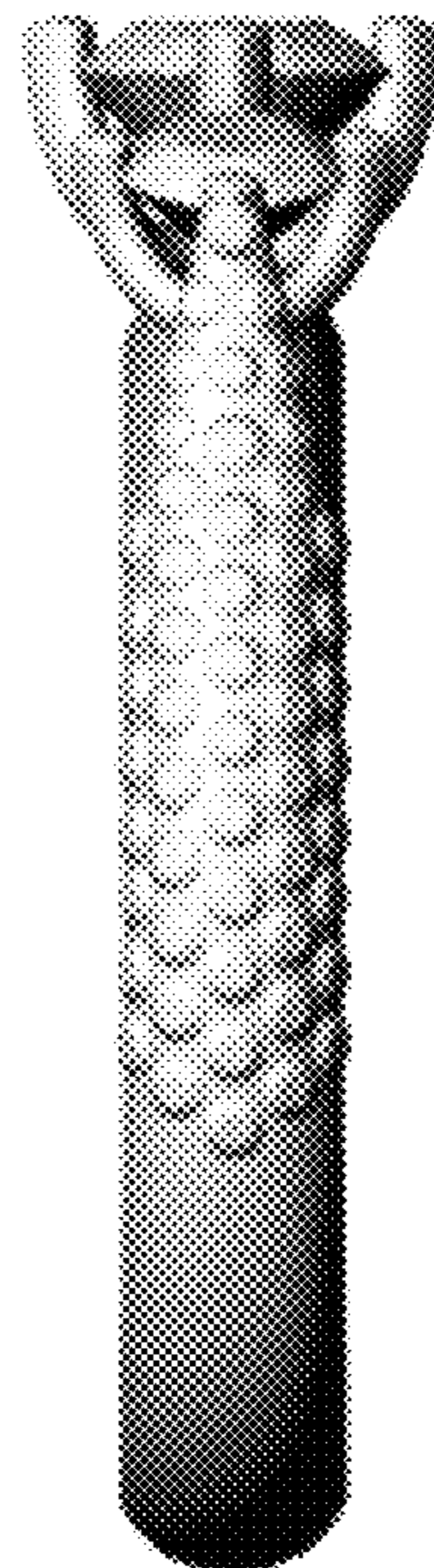

FIG. 25

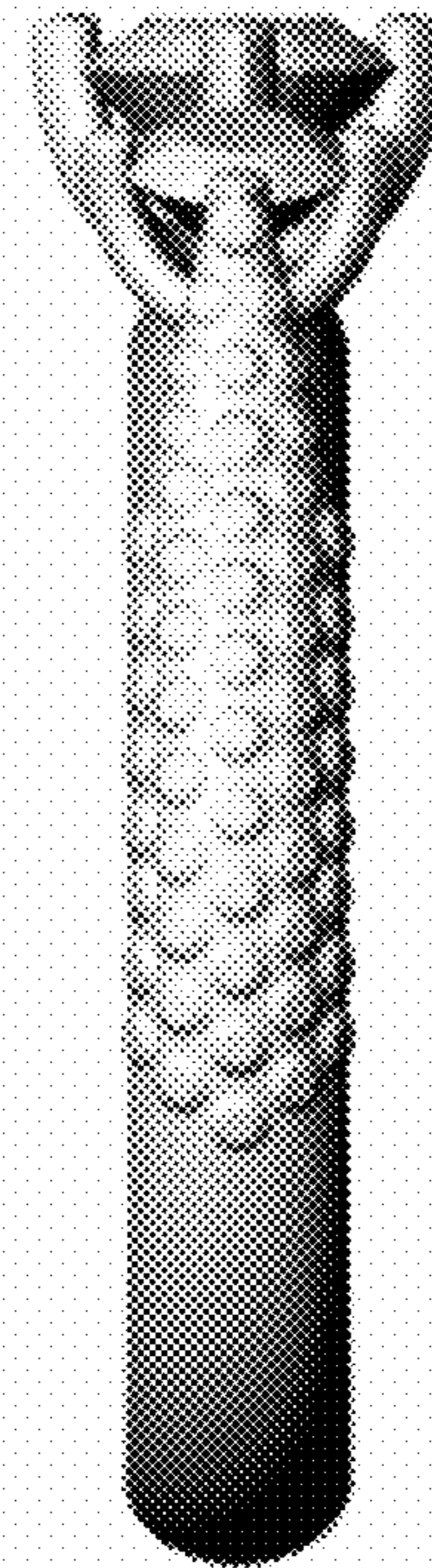

FIG. 26

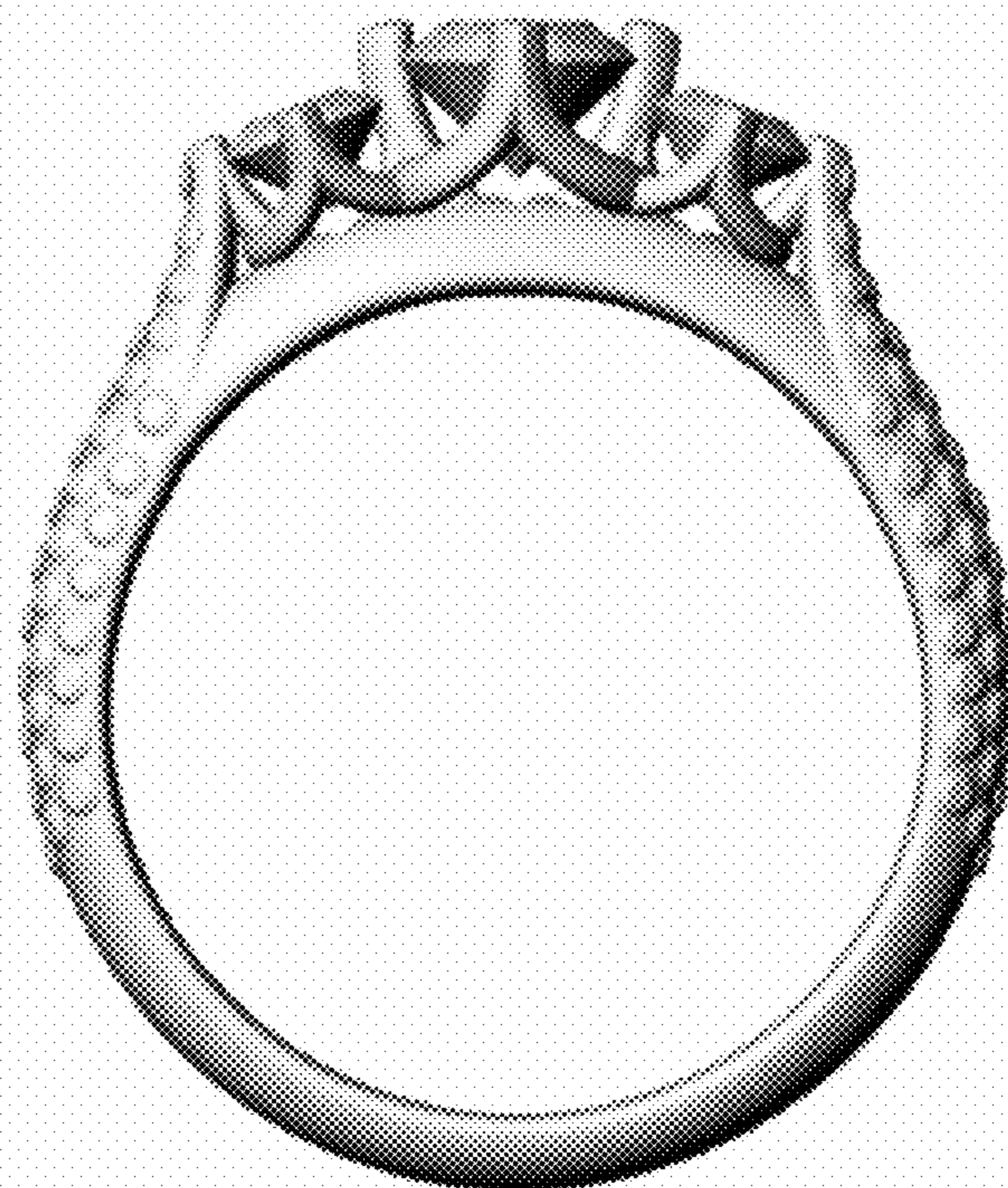

FIG. 27

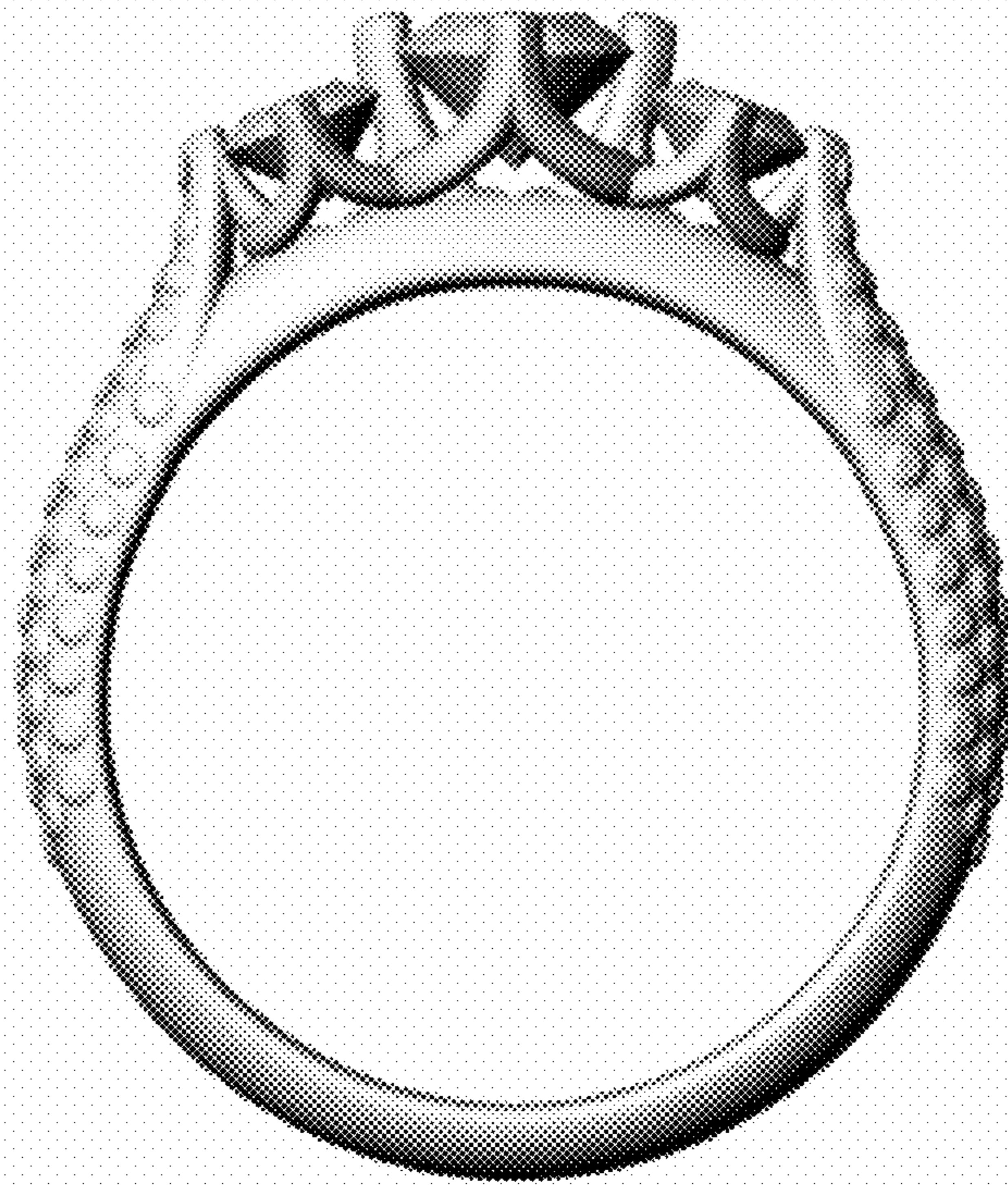

FIG. 28

