



US00D676347S

(12) **United States Design Patent**
Klein

(10) **Patent No.:** **US D676,347 S**

(45) **Date of Patent:** **** Feb. 19, 2013**

(54) **TRAFFIC CONE INSERT**

(76) Inventor: **Erik D. Klein**, Uniontown, OH (US)

(**) Term: **14 Years**

(21) Appl. No.: **29/429,504**

(22) Filed: **Aug. 13, 2012**
Related U.S. Application Data

(62) Division of application No. 29/387,374, filed on Mar. 11, 2011, now Pat. No. Des. 667,747.

(51) **LOC (9) Cl.** **10-05**

(52) **U.S. Cl.** **D10/121**

(58) **Field of Classification Search** D10/109.1,
D10/113.1, 113.2; 116/63 C, 63 P, 28 R,
116/209; 256/19; 362/152; 404/6; D21/814;
D26/28, 69

See application file for complete search history.

(56) **References Cited**

U.S. PATENT DOCUMENTS

D621,289 S * 8/2010 Cortez et al. D10/113.2
2011/0220010 A1* 9/2011 Klein et al. 116/63 C

* cited by examiner

Primary Examiner — George D Kirschbaum

(74) *Attorney, Agent, or Firm* — Zollinger & Burleson Ltd.

(57) **CLAIM**

The ornamental design for a traffic cone insert, as shown and described.

DESCRIPTION

FIG. 1 is a perspective view of a traffic cone insert with one of its heads disposed in a traffic cone to show an example of how the traffic cone insert is used.

FIG. 2 is a rear perspective view of the traffic cone insert.

FIG. 3 is a left side view thereof.

FIG. 4 is a rear elevation view.

FIG. 5 is a front elevation view.

FIG. 6 is a top plan view thereof; and,

FIG. 7 is a bottom plan view thereof.

The broken lines shown in the drawings are for environmental purposes only and form no part of the claimed design.

1 Claim, 3 Drawing Sheets

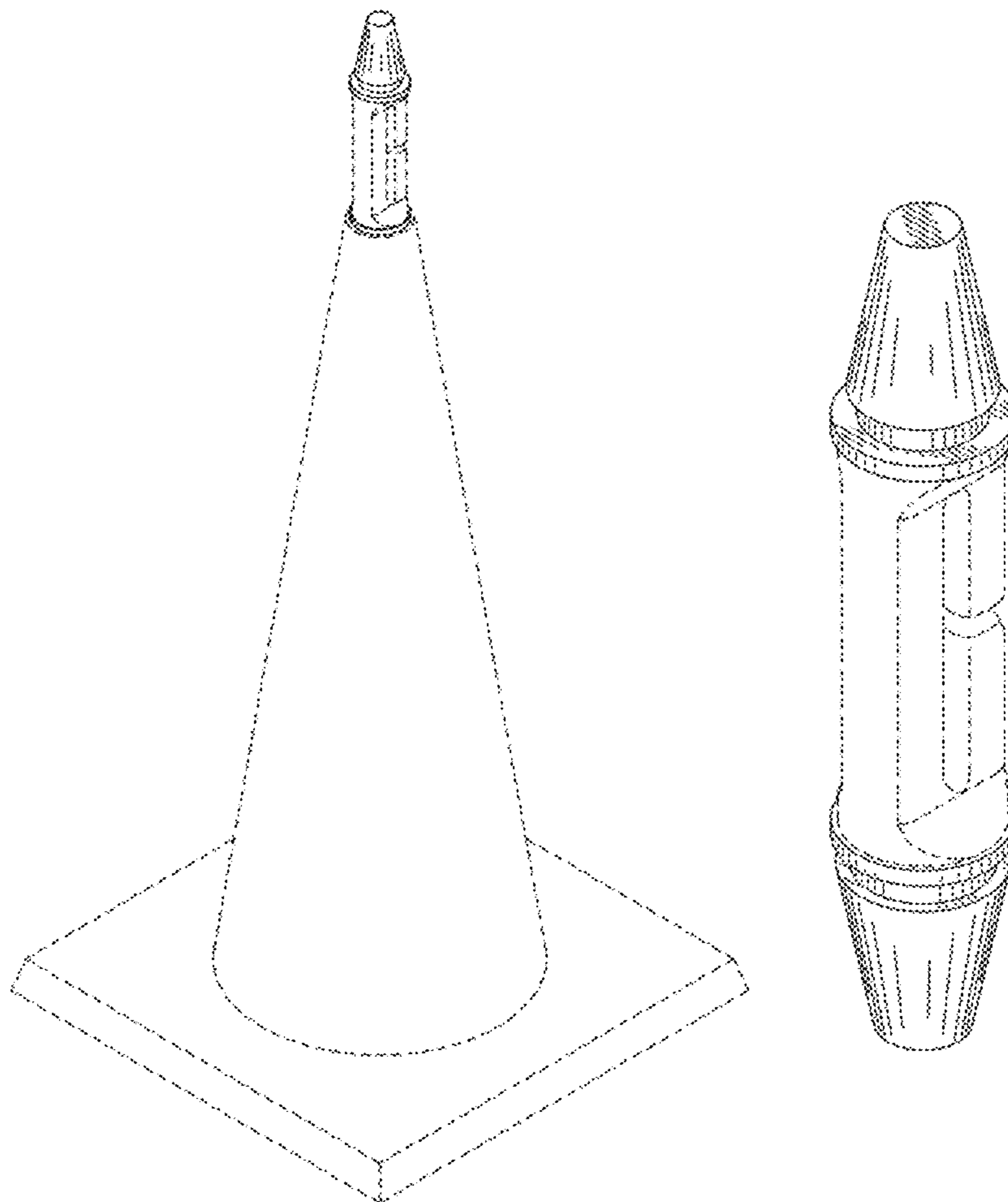

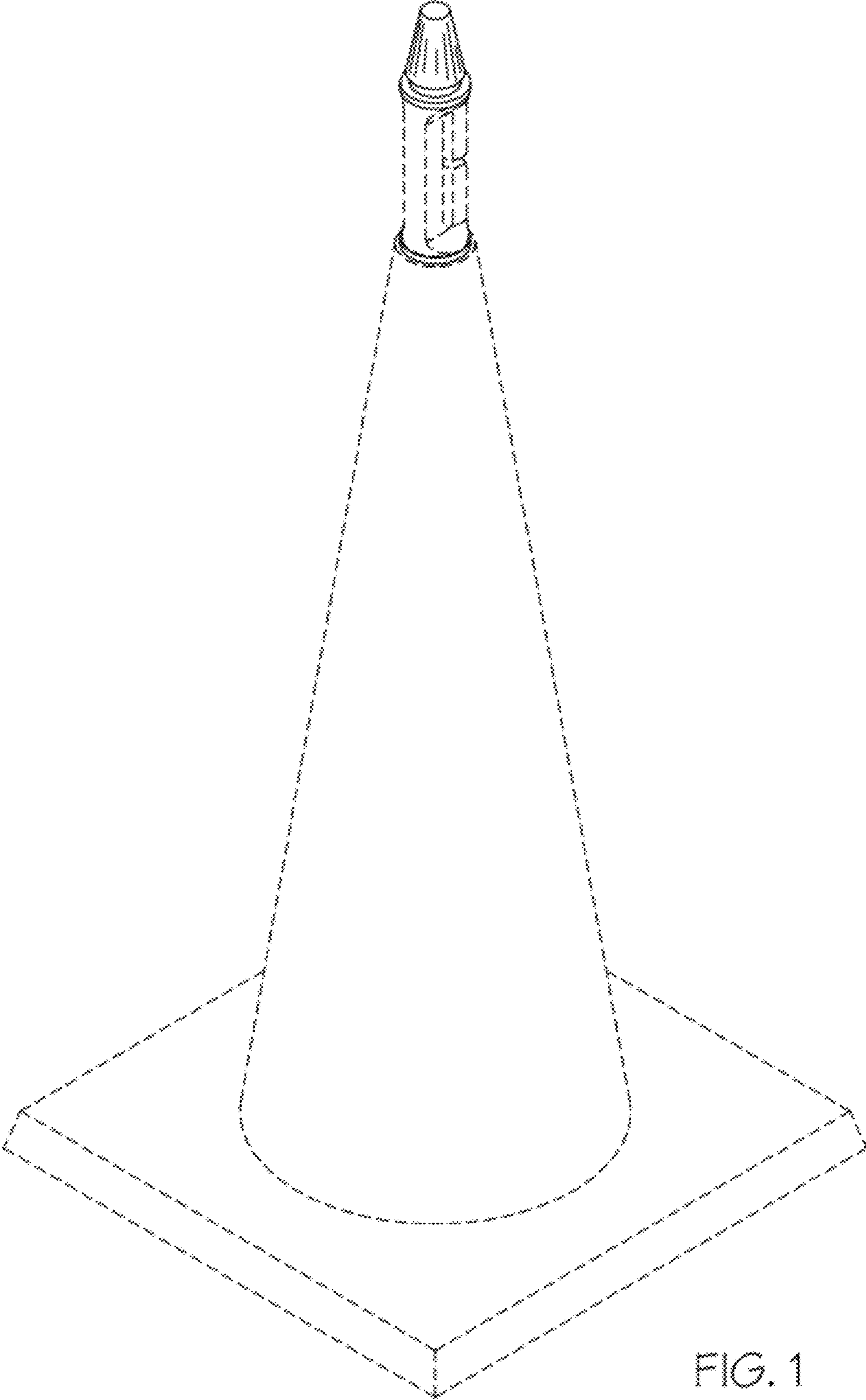

FIG. 1

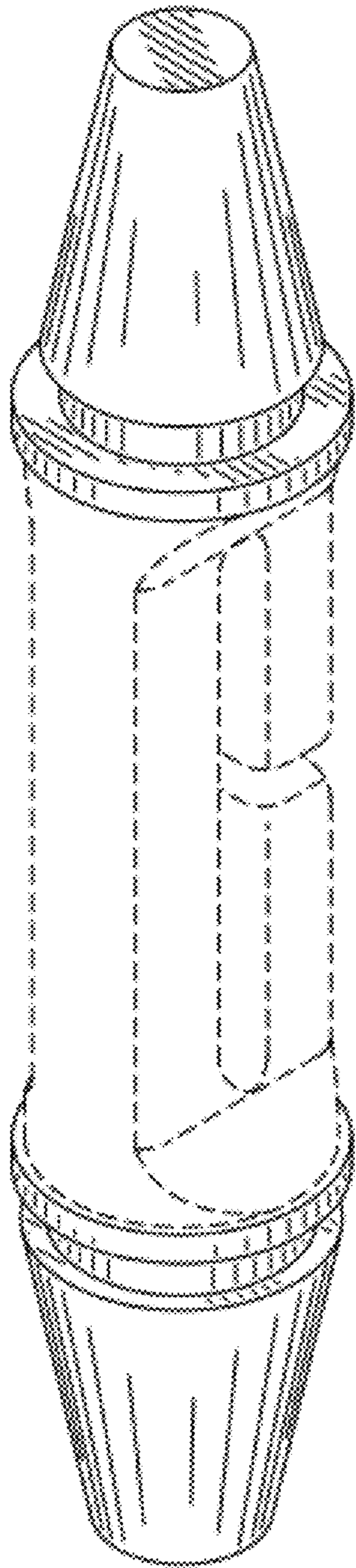

FIG. 2

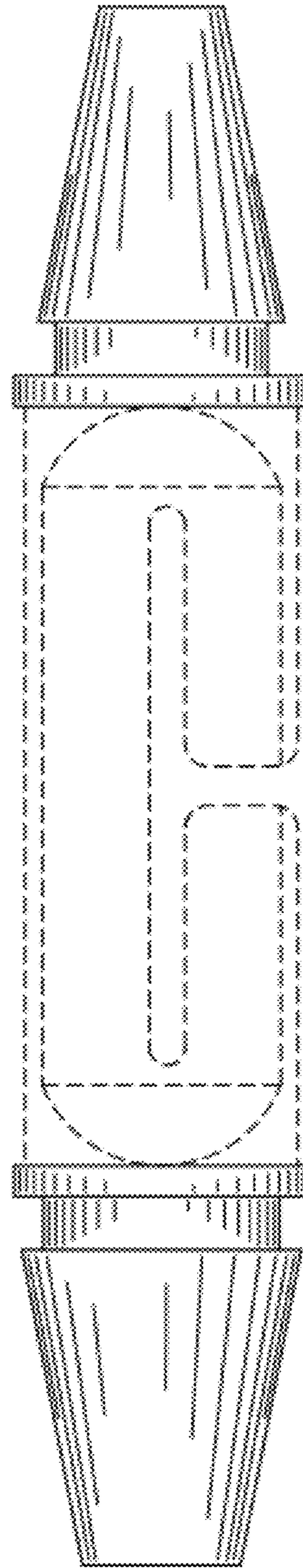

FIG. 3

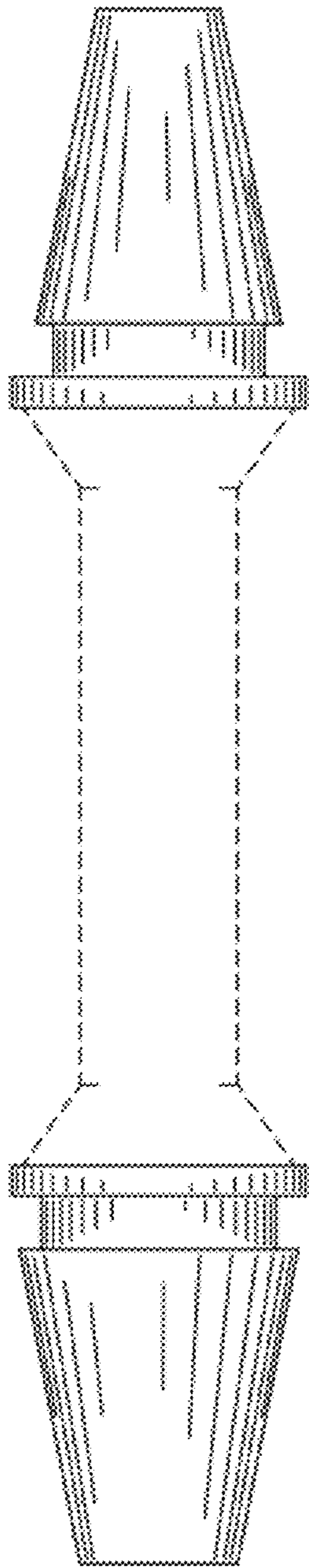

FIG. 4

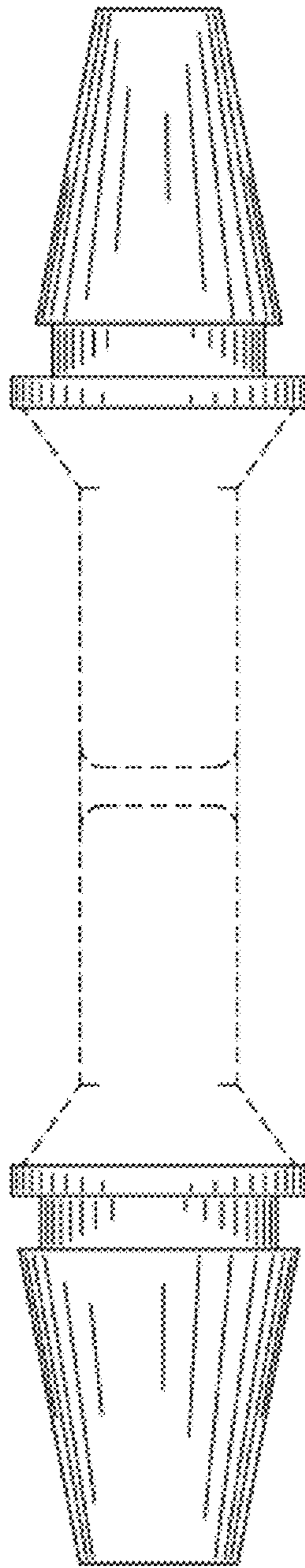

FIG. 5

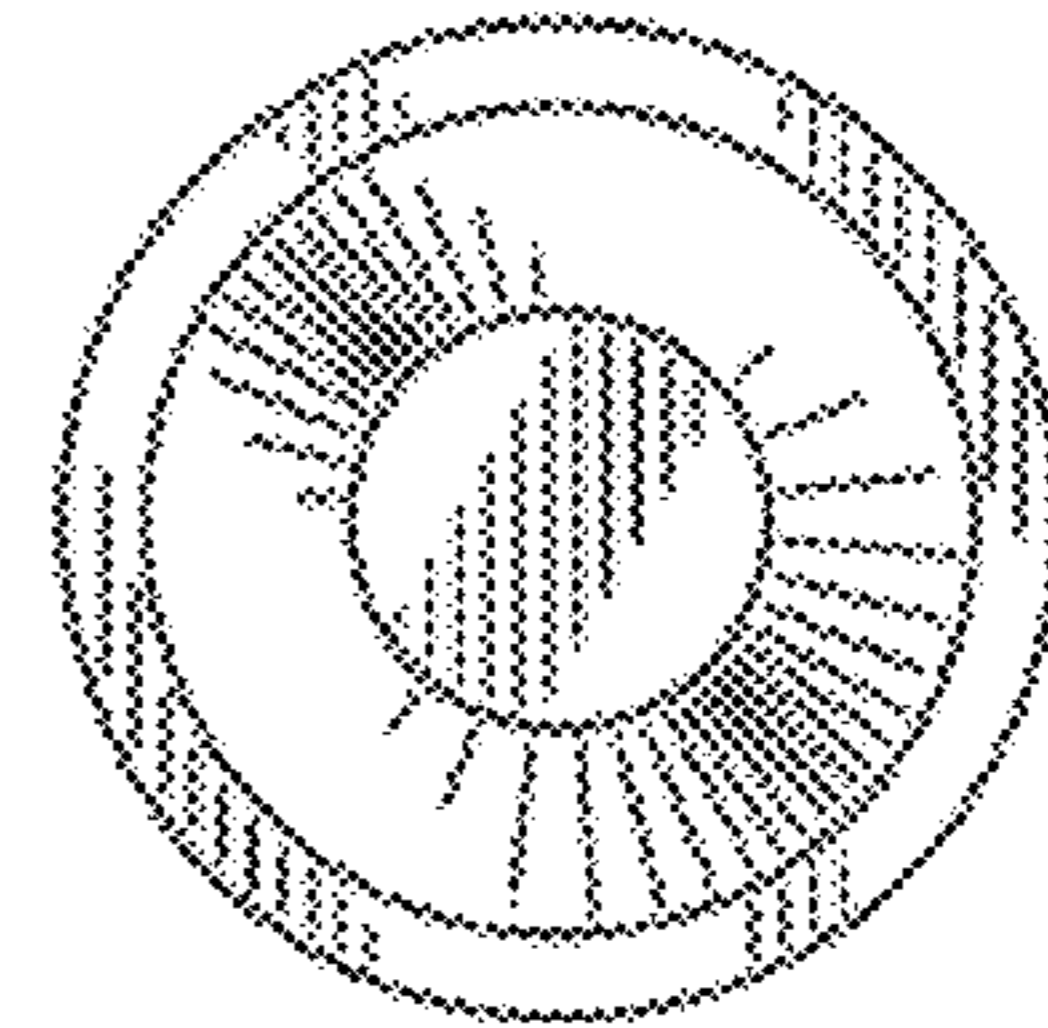

FIG. 6

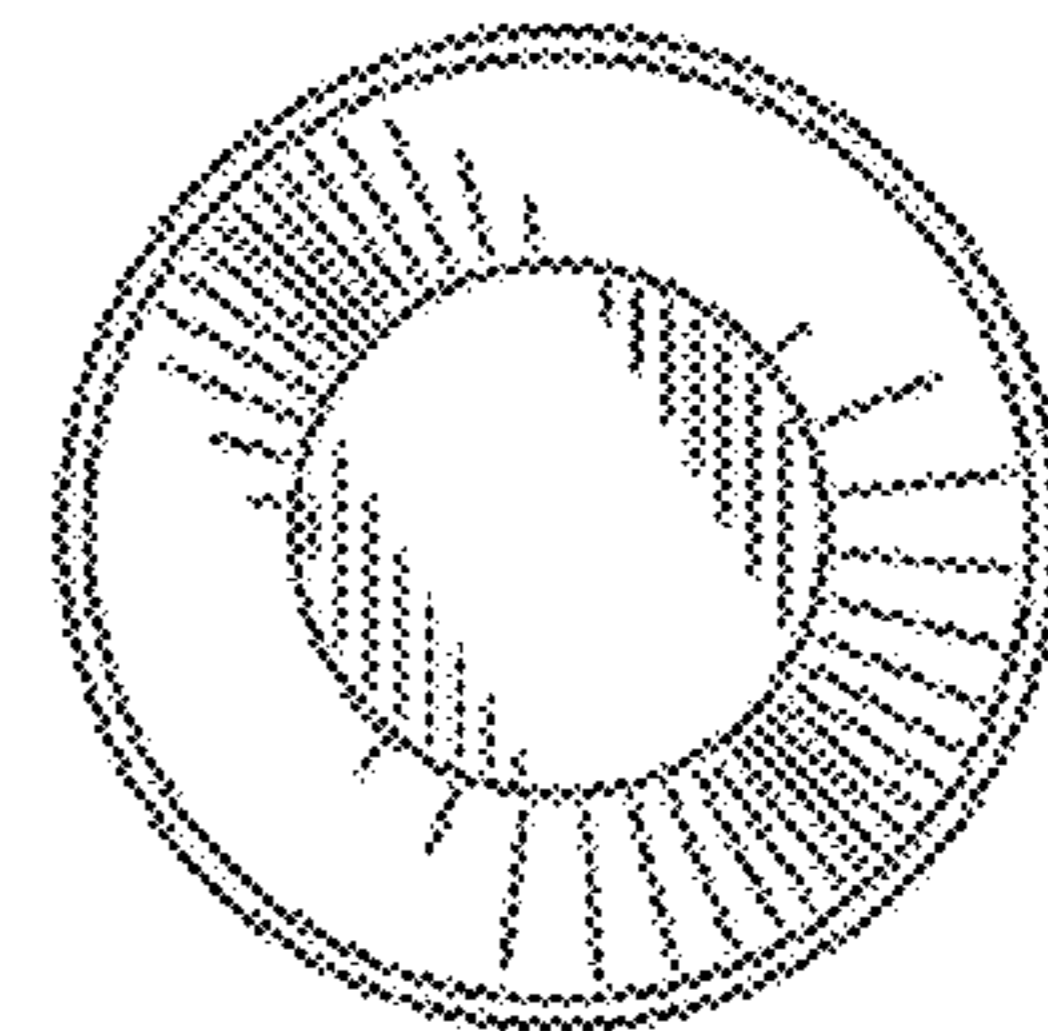

FIG. 7