



US00D676345S

(12) **United States Design Patent**
Sterling et al.

(10) **Patent No.:** **US D676,345 S**

(45) **Date of Patent:** **** Feb. 19, 2013**

(54) **RADAR DETECTOR WITH FOLD-OUT DISPLAY**

(75) Inventors: **Jeffrey A. Sterling**, Lombard, IL (US);
Philip E. Thistlethwaite, Arlington Heights, IL (US); **Hiroshi Kainuma**, Arlington Heights, IL (US); **Byunghyuk Han**, Yongin-si (KR); **Hojae Jang**, Incheon (KR); **Dongmin Han**, Gunpo-si (KR)

(73) Assignee: **Cobra Electronics Corporation**, Chicago, IL (US)

(**) Term: **14 Years**

(21) Appl. No.: **29/404,661**

(22) Filed: **Oct. 24, 2011**

(51) **LOC (9) Cl.** **10-05**

(52) **U.S. Cl.** **D10/104.1**

(58) **Field of Classification Search** D10/104.1,
D10/104.2, 46; 340/20

See application file for complete search history.

(56) **References Cited**

U.S. PATENT DOCUMENTS

D450,007 S * 11/2001 Volanski et al. D10/104.1

D468,224 S * 1/2003 Kainuma et al. D10/104.1

* cited by examiner

Primary Examiner — George D Kirschbaum

(74) *Attorney, Agent, or Firm* — Hitchcock Evert LLP

(57) **CLAIM**

The ornamental design for a radar detector with fold-out display, as shown and described.

DESCRIPTION

FIG. 1 is a perspective view of a radar detector with fold-out display in a closed position; FIG. 2 is a front view thereof; FIG. 3 is a back view thereof; FIG. 4 is a right side view thereof; FIG. 5 is a left side view thereof; FIG. 6 is a top view thereof; and FIG. 7 is a bottom view thereof; FIG. 8 is a perspective view of a radar detector with fold-out display in an open position; FIG. 9 is a front view thereof; FIG. 10 is a back view thereof; FIG. 11 is a left side view thereof; FIG. 12 is a right side view thereof; FIG. 13 is a top view thereof; and, FIG. 14 is a bottom view thereof.

The broken lines are for illustrative purposes only and form no part of the claimed design.

1 Claim, 12 Drawing Sheets

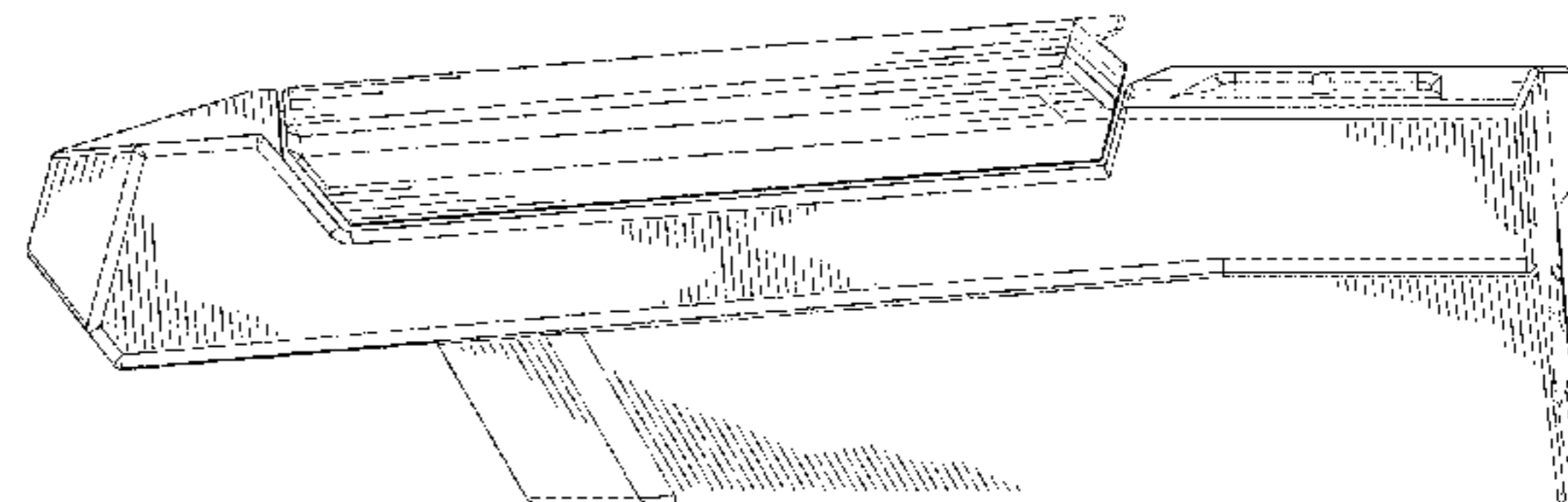
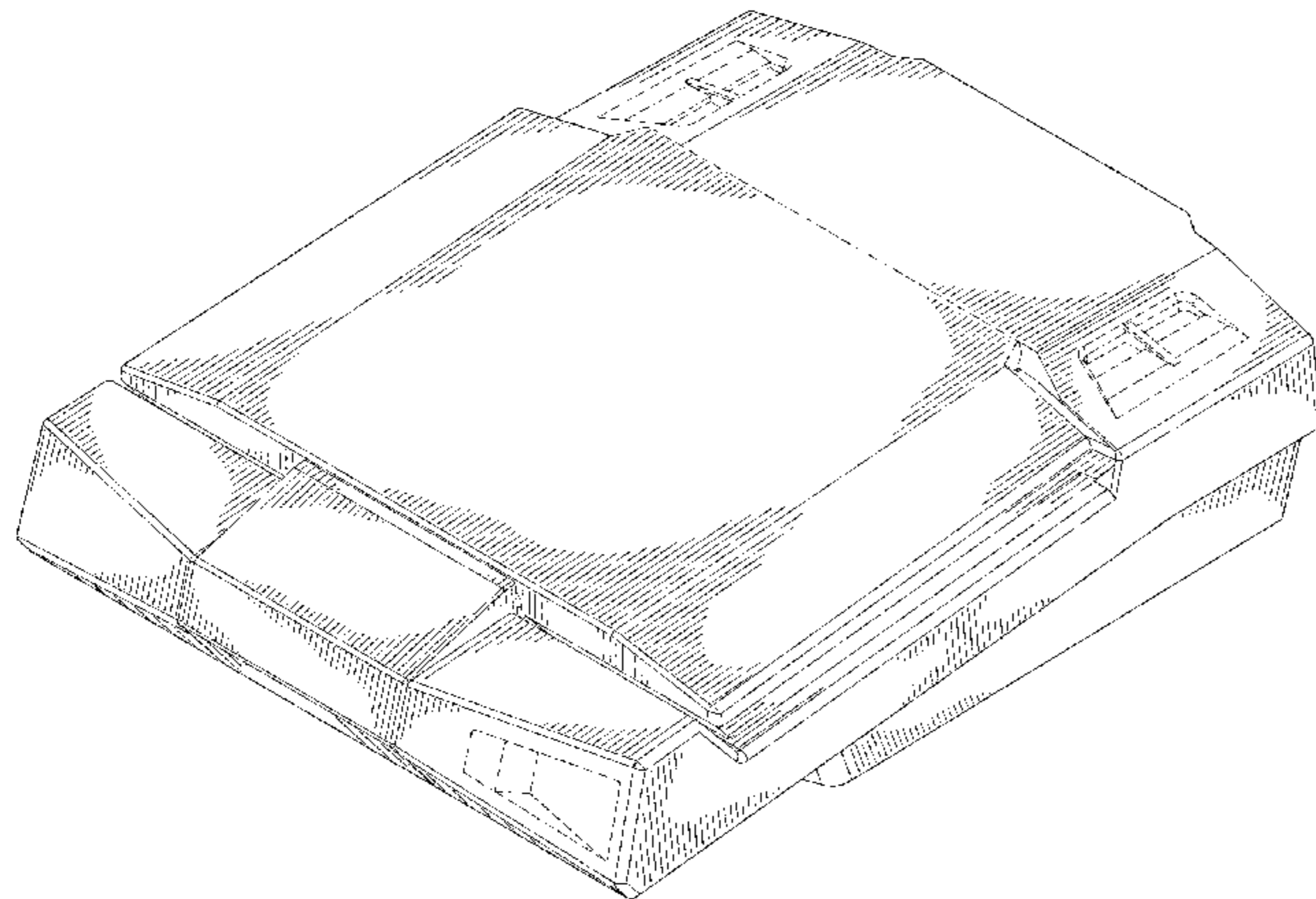

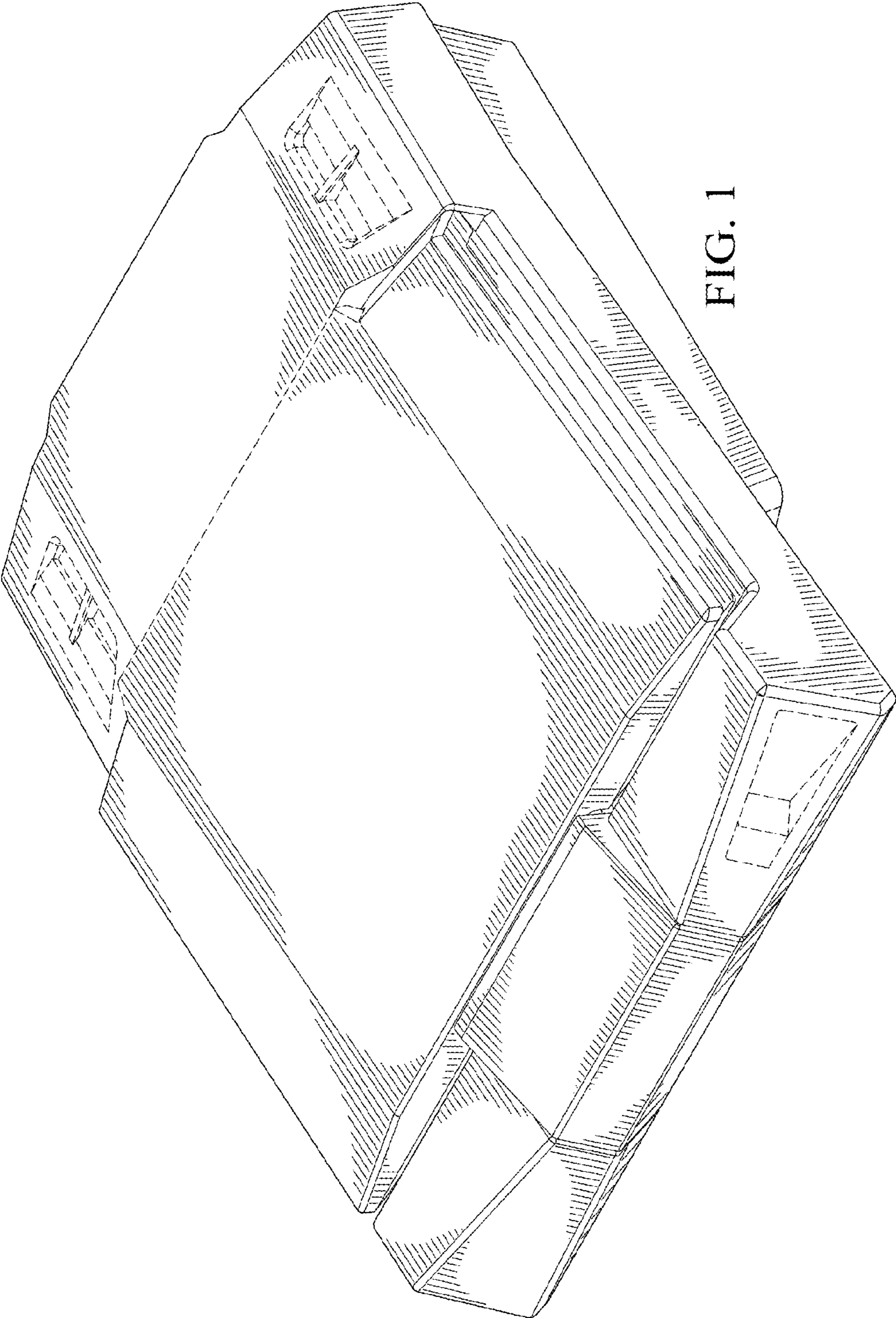

FIG. 1

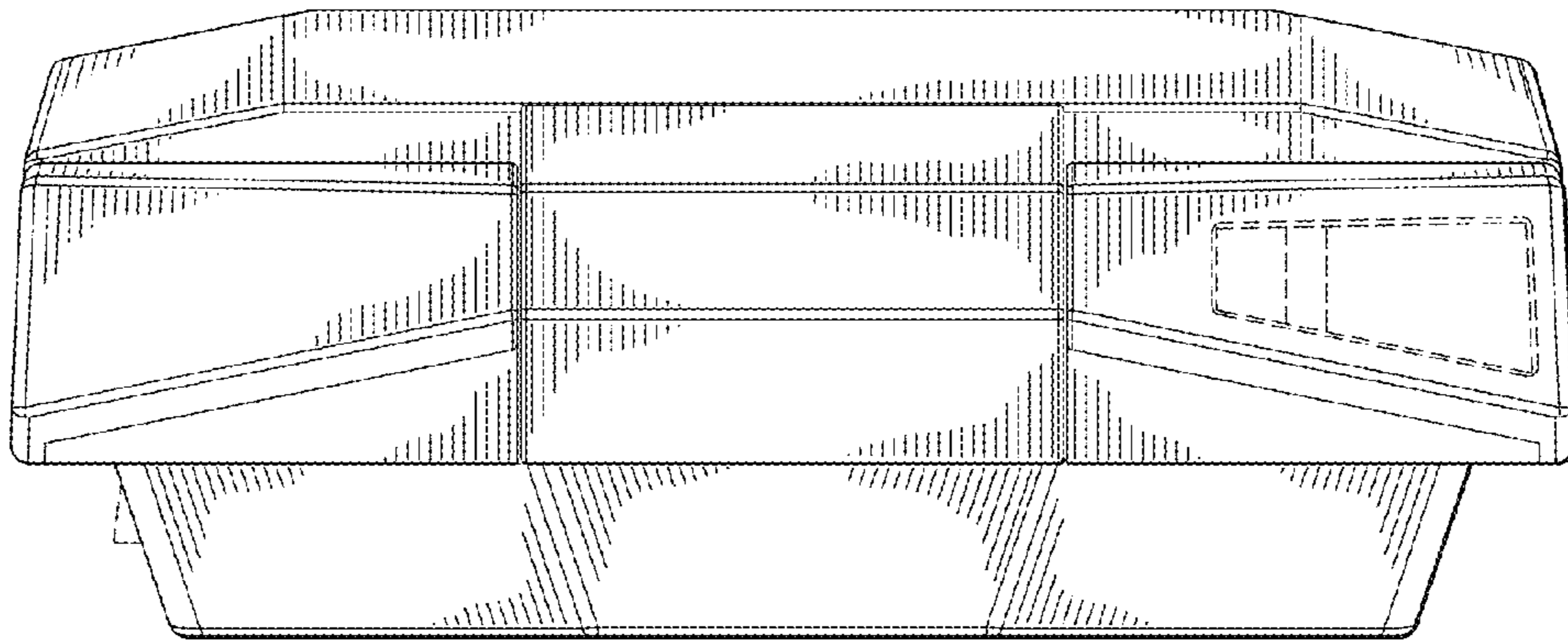

FIG. 2

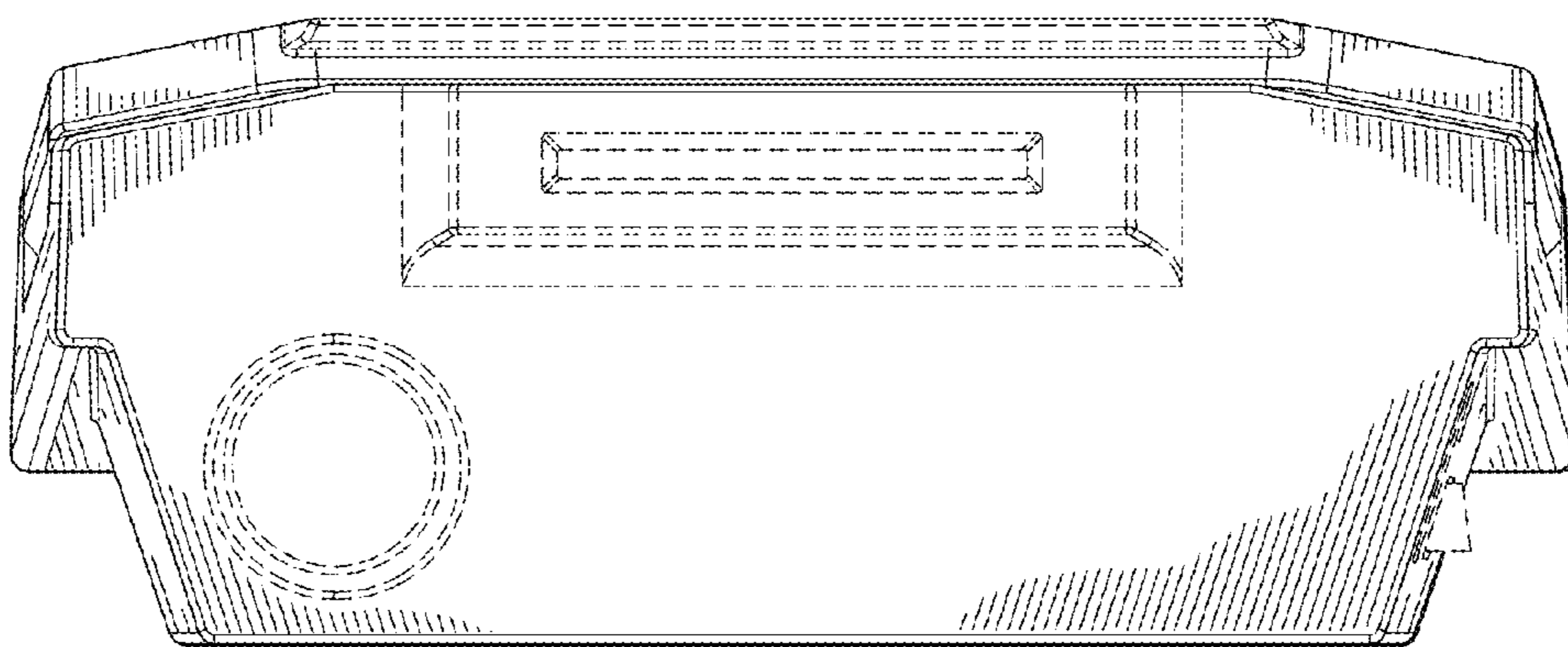

FIG. 3

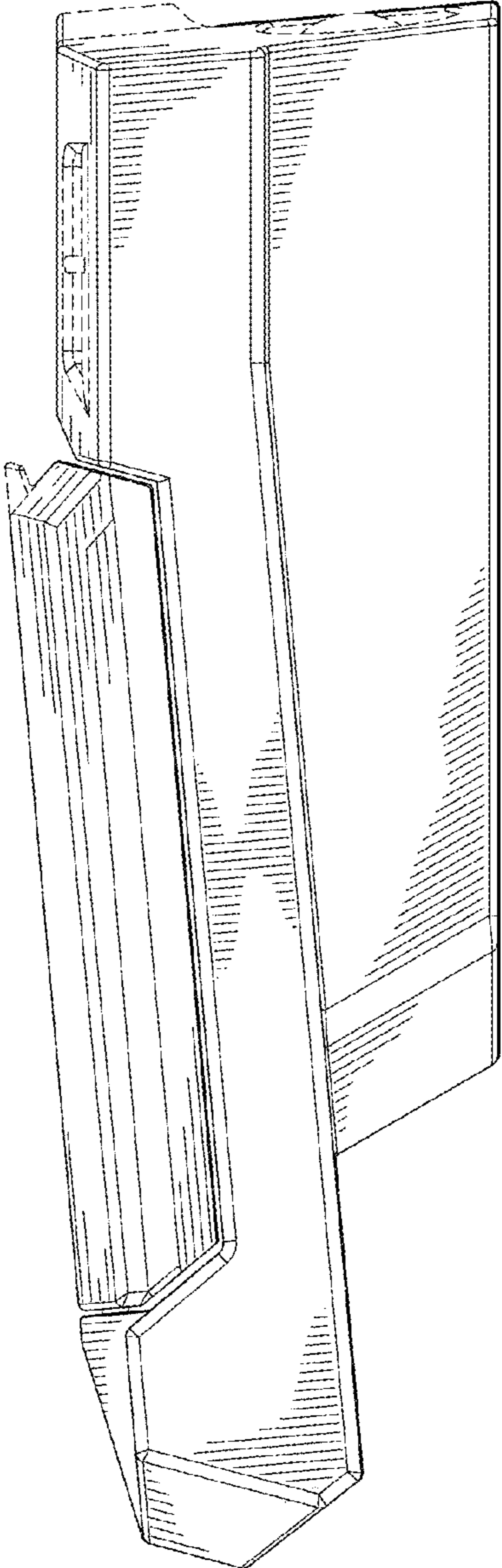

FIG. 4

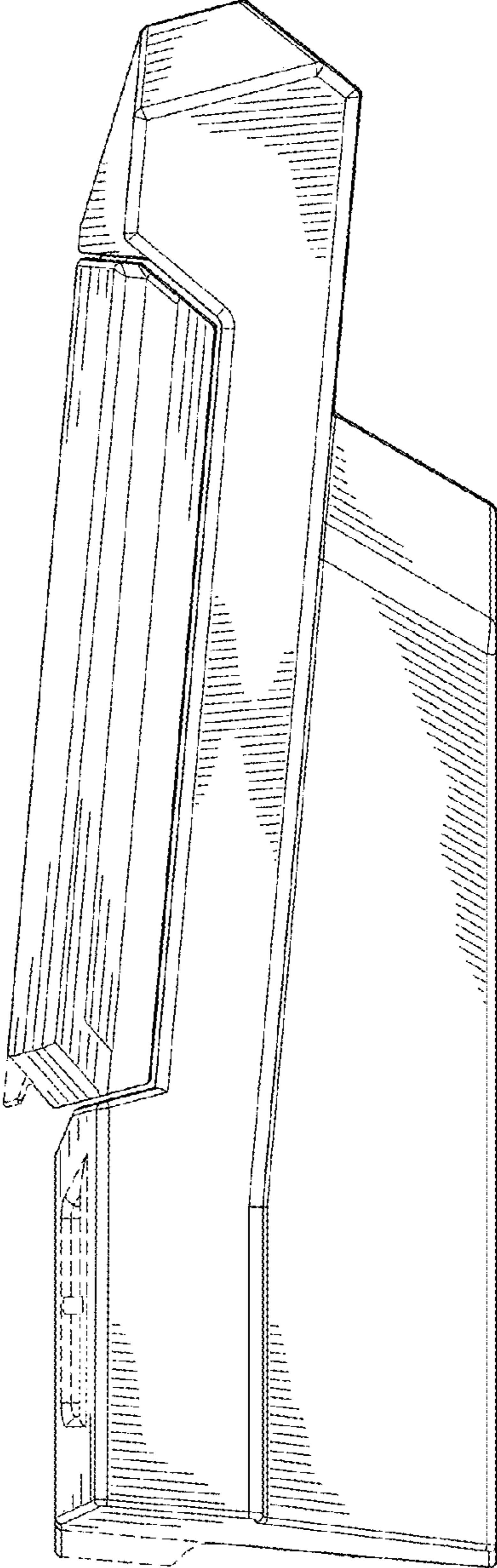

FIG. 5

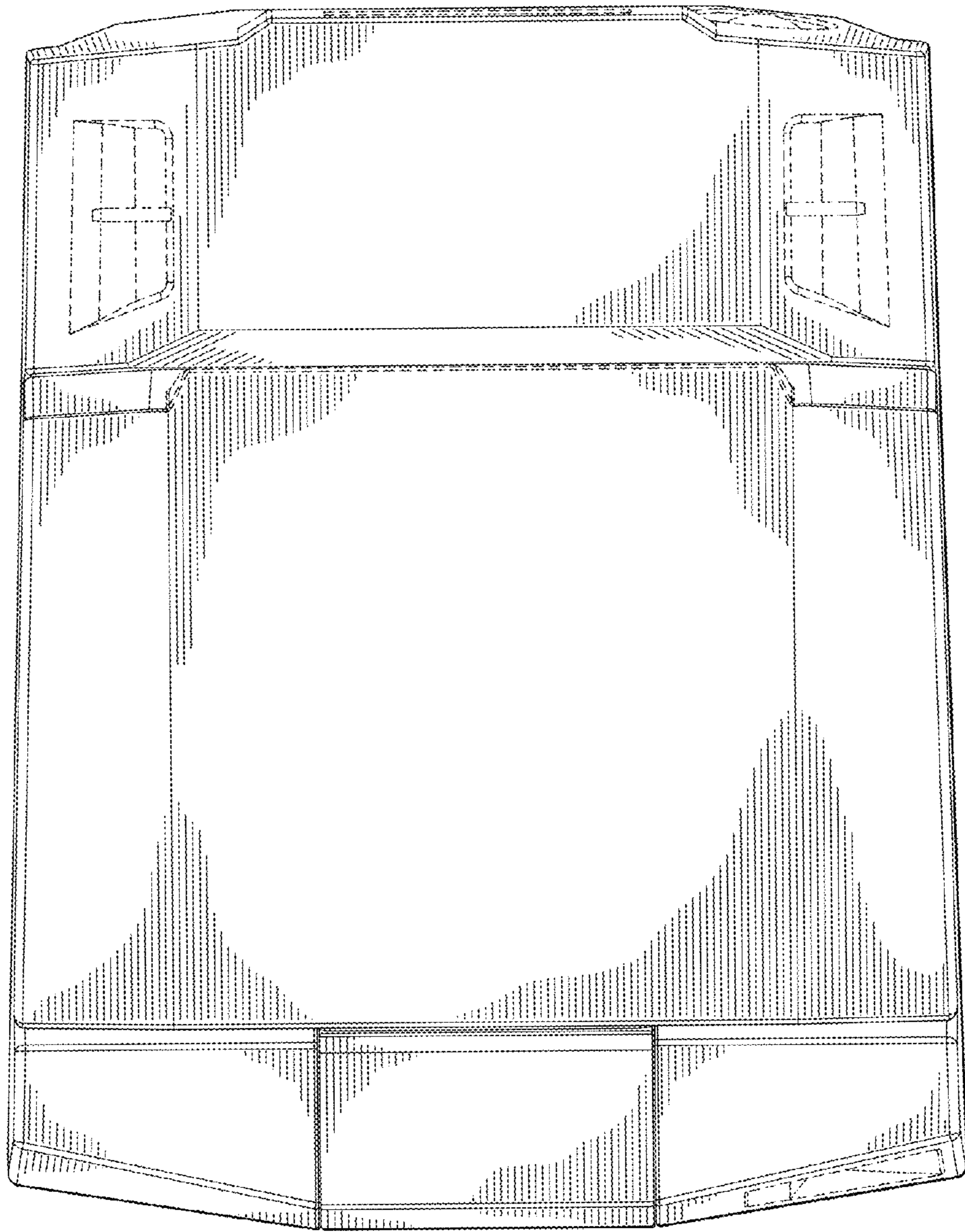

FIG. 6

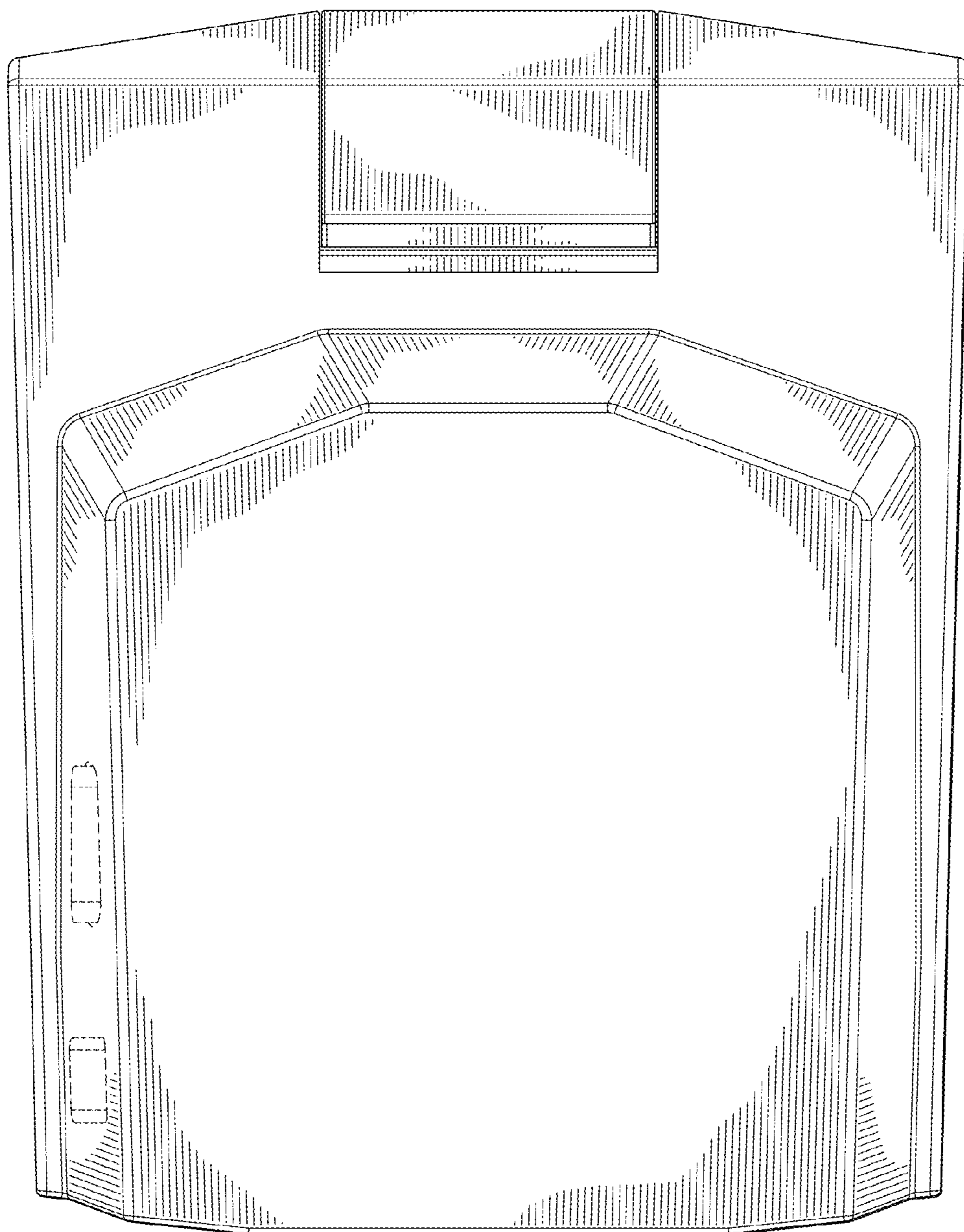

FIG. 7

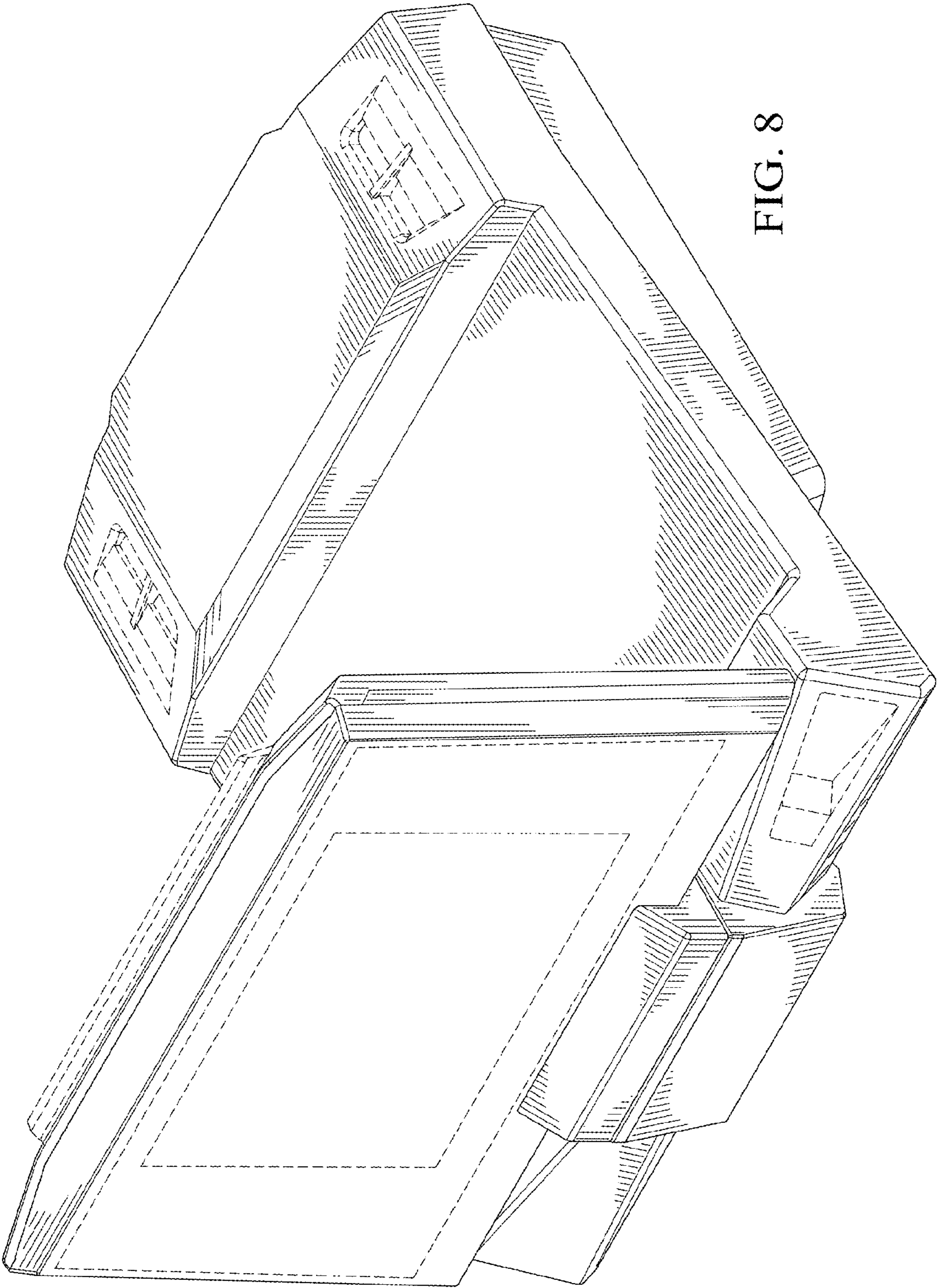

FIG. 8

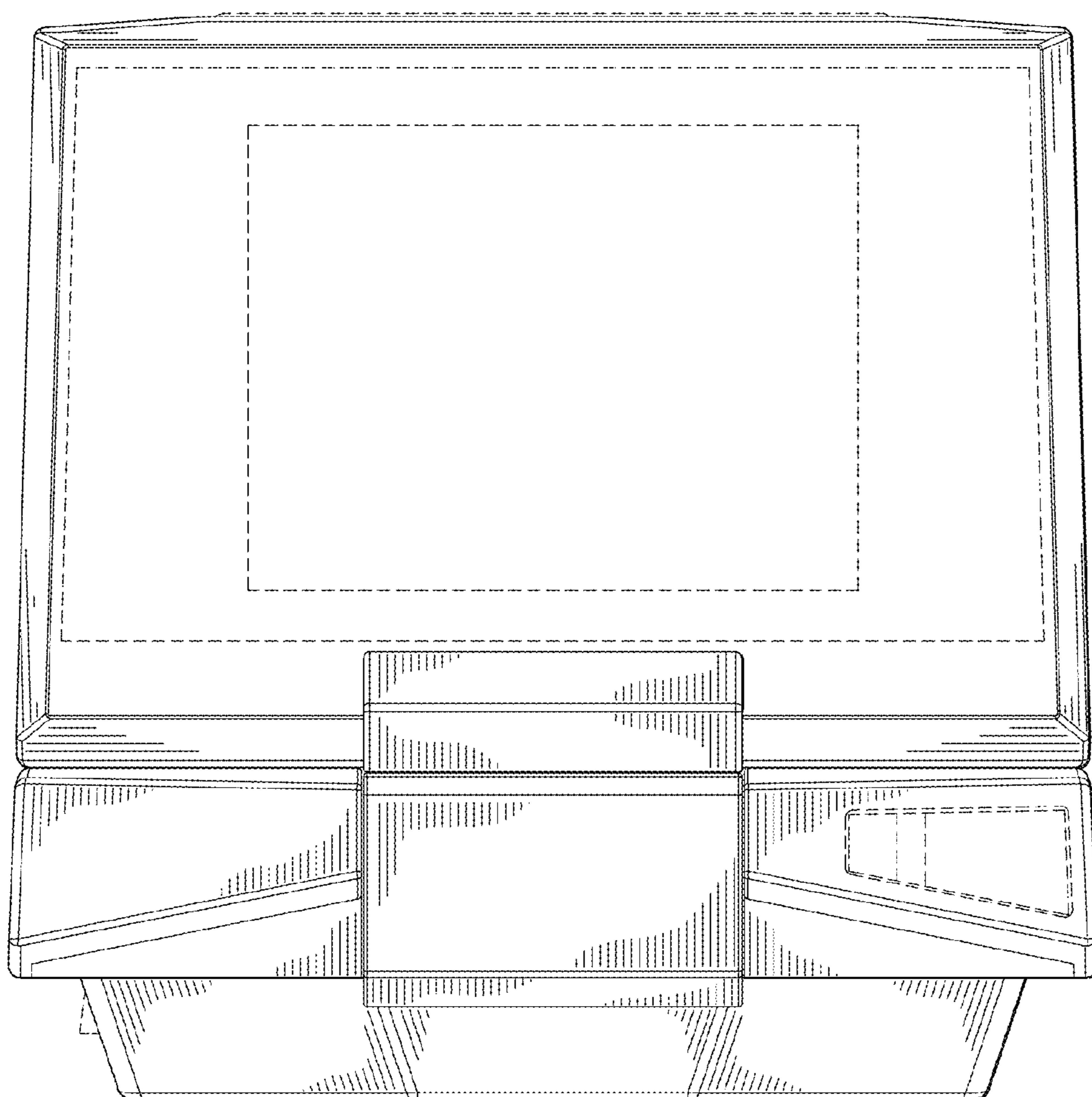

FIG. 9

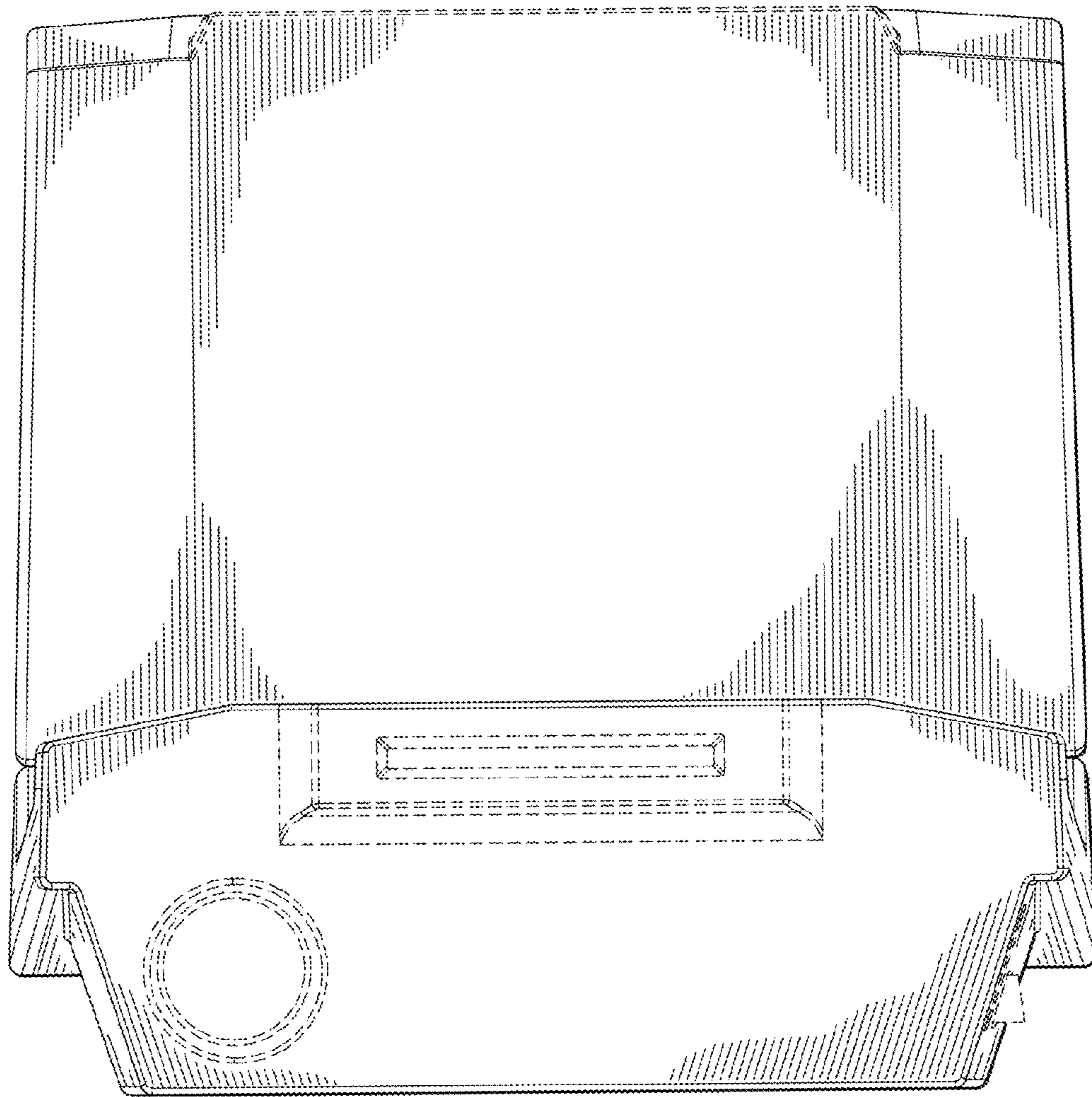

FIG. 10



FIG. 11

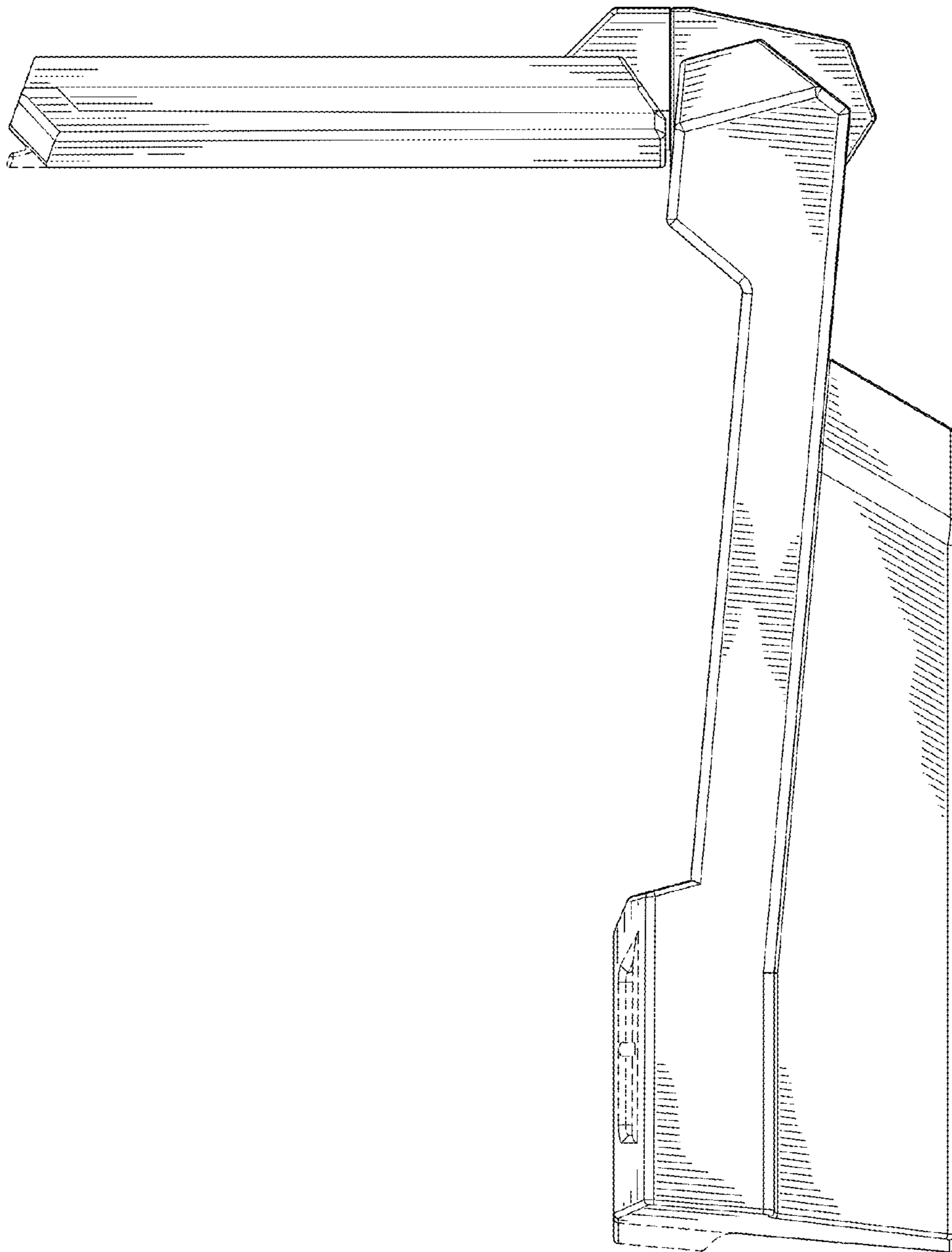

FIG. 12

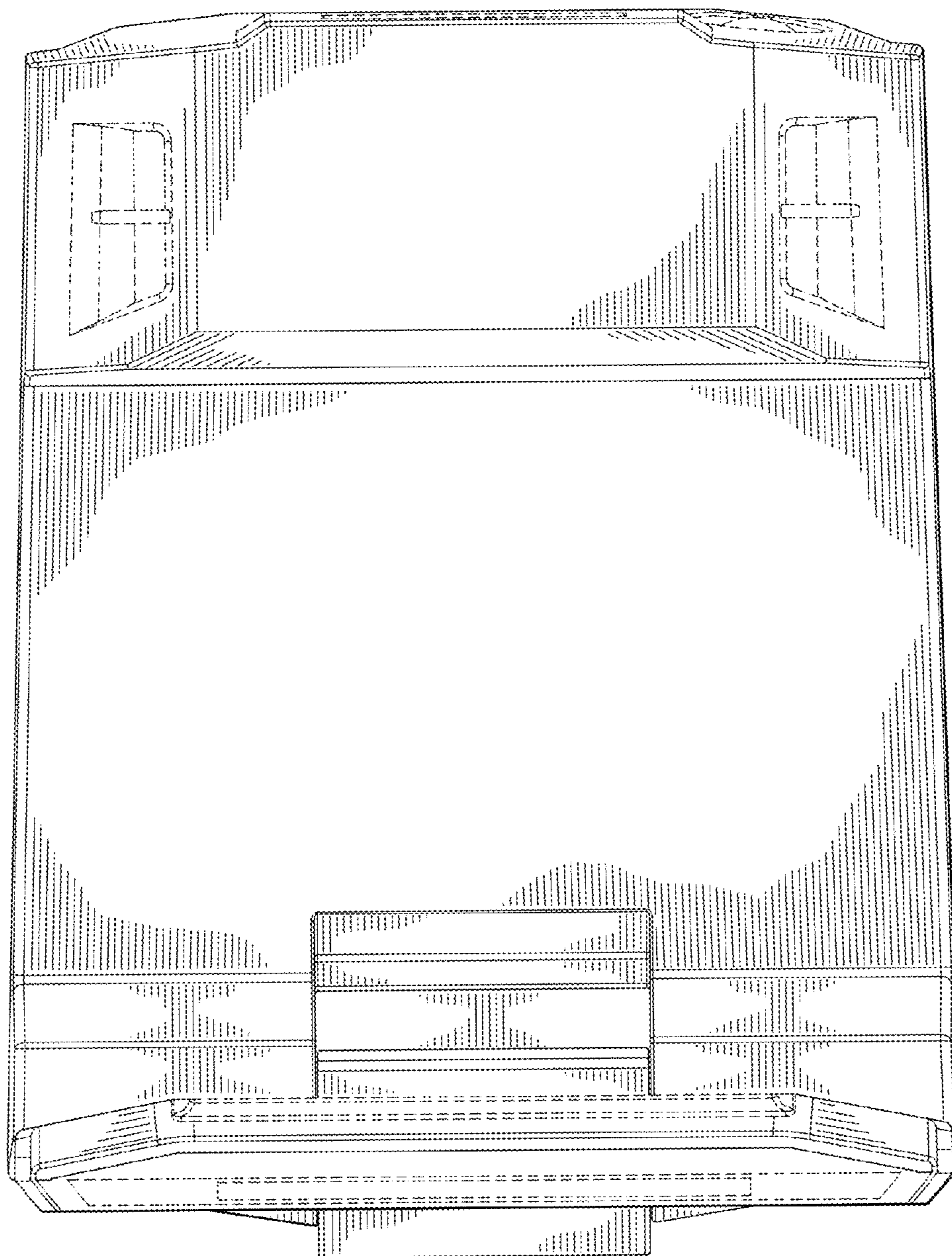

FIG. 13

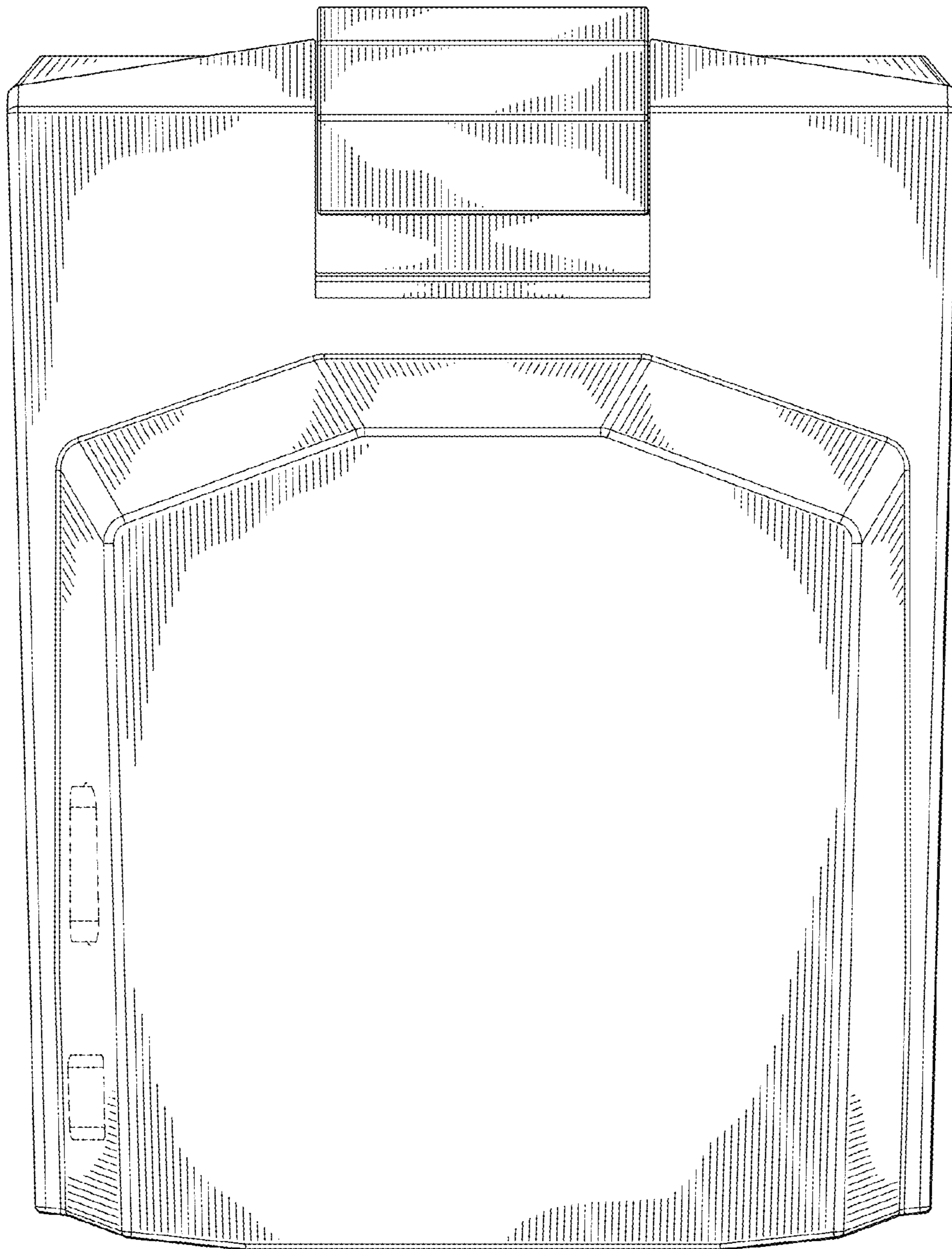

FIG. 14