



US00D676317S

(12) **United States Design Patent**
De Klerk

(10) **Patent No.:** **US D676,317 S**

(45) **Date of Patent:** **** Feb. 19, 2013**

(54) **REMOVABLE HYGIENIC SEAL FOR A BEVERAGE CONTAINER**

(74) *Attorney, Agent, or Firm* — Schwegman, Lundberg & Woessner, P.A.

(76) Inventor: **Francois Stefanus De Klerk**, Frankfort (ZA)

(57) **CLAIM**
The ornamental design for a removable hygienic seal for a beverage container, as shown and described.

(**) Term: **14 Years**

(21) Appl. No.: **29/409,293**

DESCRIPTION

(22) Filed: **Dec. 21, 2011**

(30) **Foreign Application Priority Data**

Oct. 20, 2011 (ZA) F2011/01671

(51) **LOC (9) Cl.** **09-07**

(52) **U.S. Cl.** **D9/435**

(58) **Field of Classification Search** D9/431,
D9/432, 434, 435, 438, 454, 455, 456, 457,
D9/499, 701, 702, 707; 229/123.1; 220/259.2,
220/259.3, 259.4, 265, 359.1, 359.3; 215/232;
206/530

See application file for complete search history.

FIG. 1 is a perspective view from above of a removable hygienic seal for a beverage container, showing the new design.

FIG. 2 is a perspective view from below of a removable hygienic seal for a beverage container, showing the new design.

FIG. 3 is a top view of the removable hygienic seal for a beverage container.

FIG. 4 is a bottom view of the removable hygienic seal for a beverage container.

FIG. 5 is a back outside view of the removable hygienic seal for a beverage container.

FIG. 6 is a front inside view of the removable hygienic seal for a beverage container.

FIG. 7 is a cross-sectional side view along the line of FIG. 6 of the removable hygienic seal for a beverage container.

FIG. 8 is a perspective view with seal in place on a beverage can of the removable hygienic seal for a beverage container; and,

FIG. 9 is a perspective view with the seal partially removed from a beverage can of the removable hygienic seal for a beverage container.

The broken lines depict environmental subject matter only and form no part of the claimed design.

(56) **References Cited**

U.S. PATENT DOCUMENTS

D651,898 S *	1/2012	Hess	D9/435
D651,899 S *	1/2012	Frias	D9/435
D652,297 S *	1/2012	Dunwoody	D9/435
D666,488 S *	9/2012	Frias	D9/435

* cited by examiner

Primary Examiner — Susan Bennett Hattan

Assistant Examiner — Barbara B Lohr

1 Claim, 6 Drawing Sheets

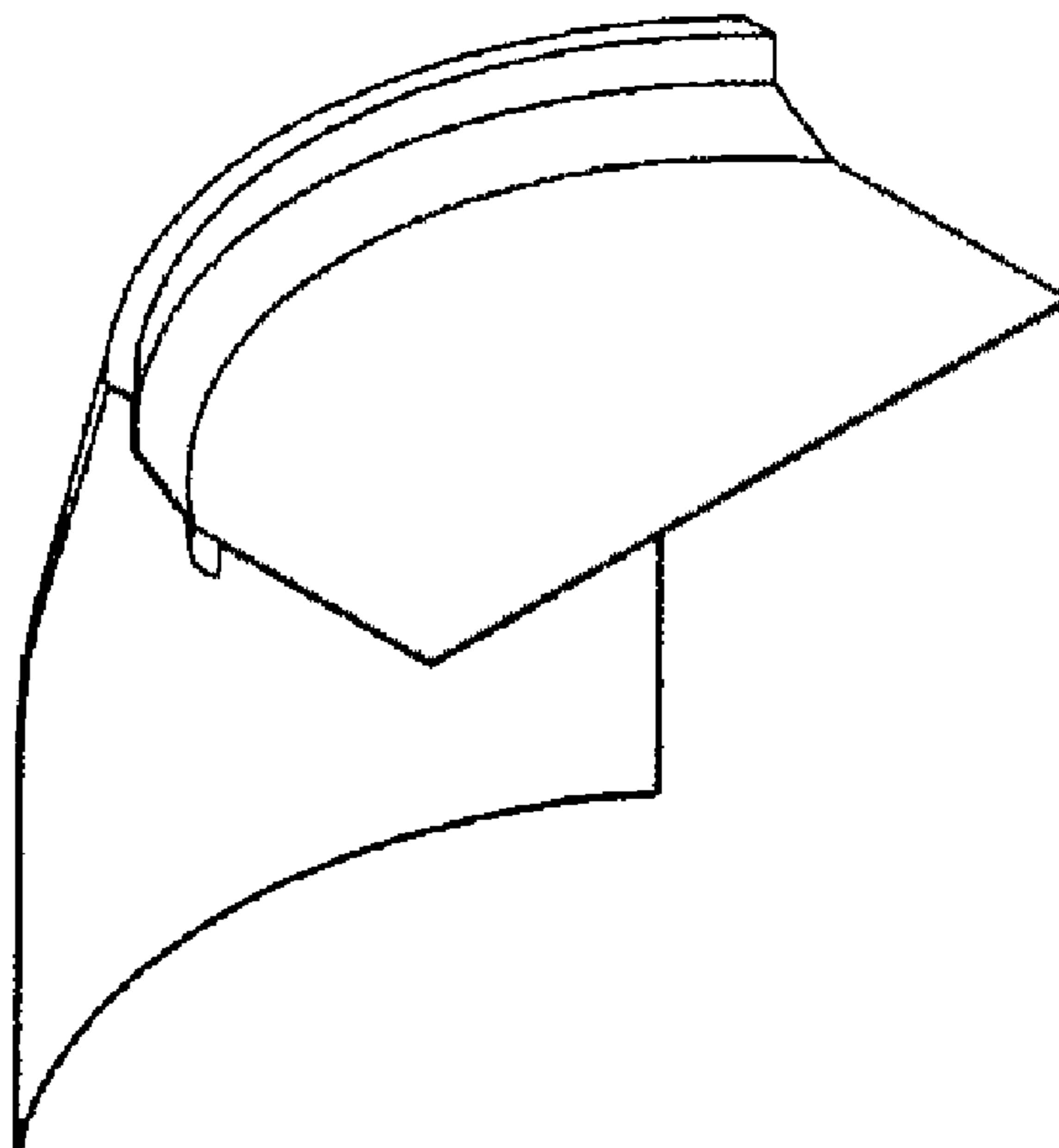

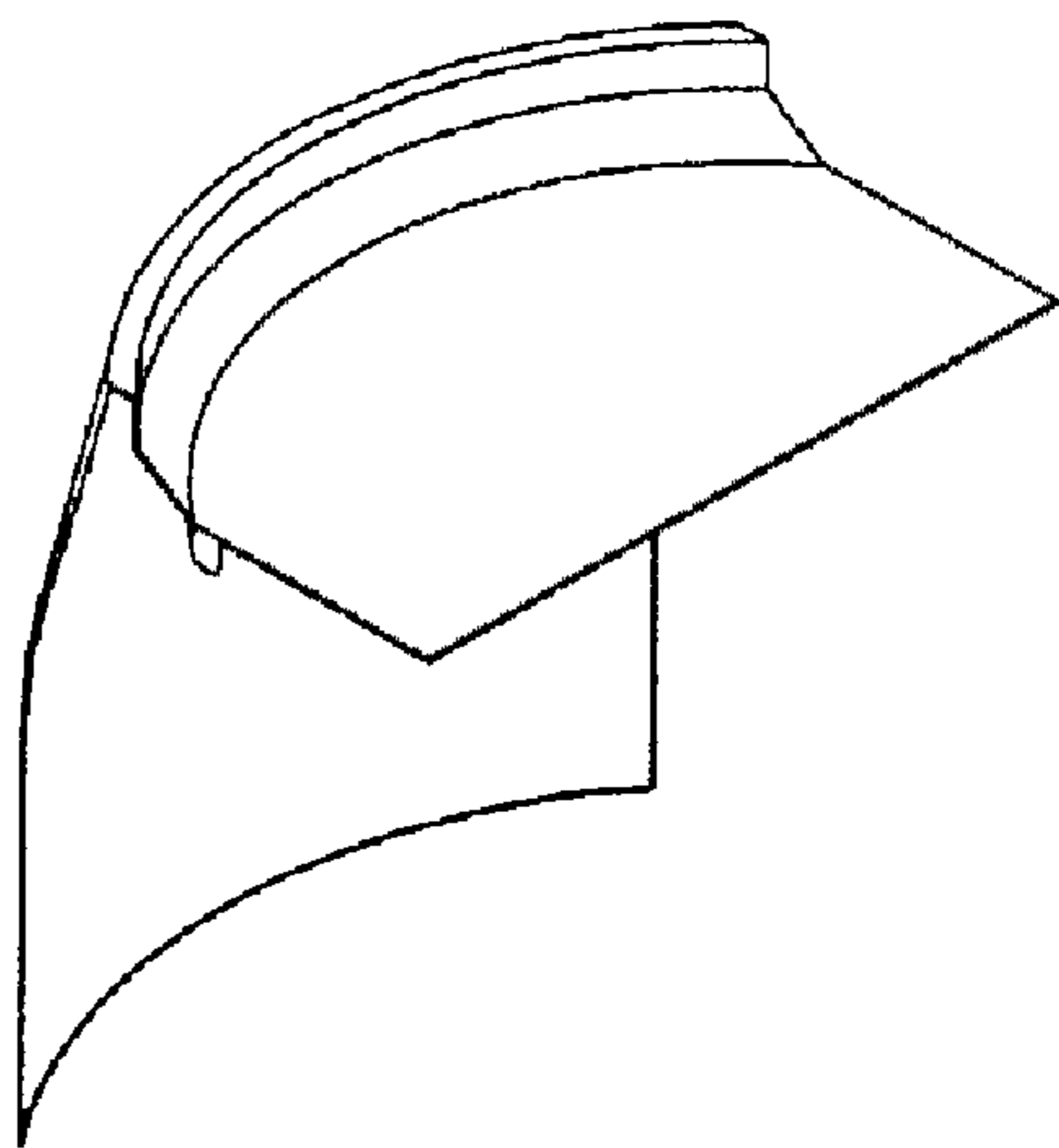

FIG. 1

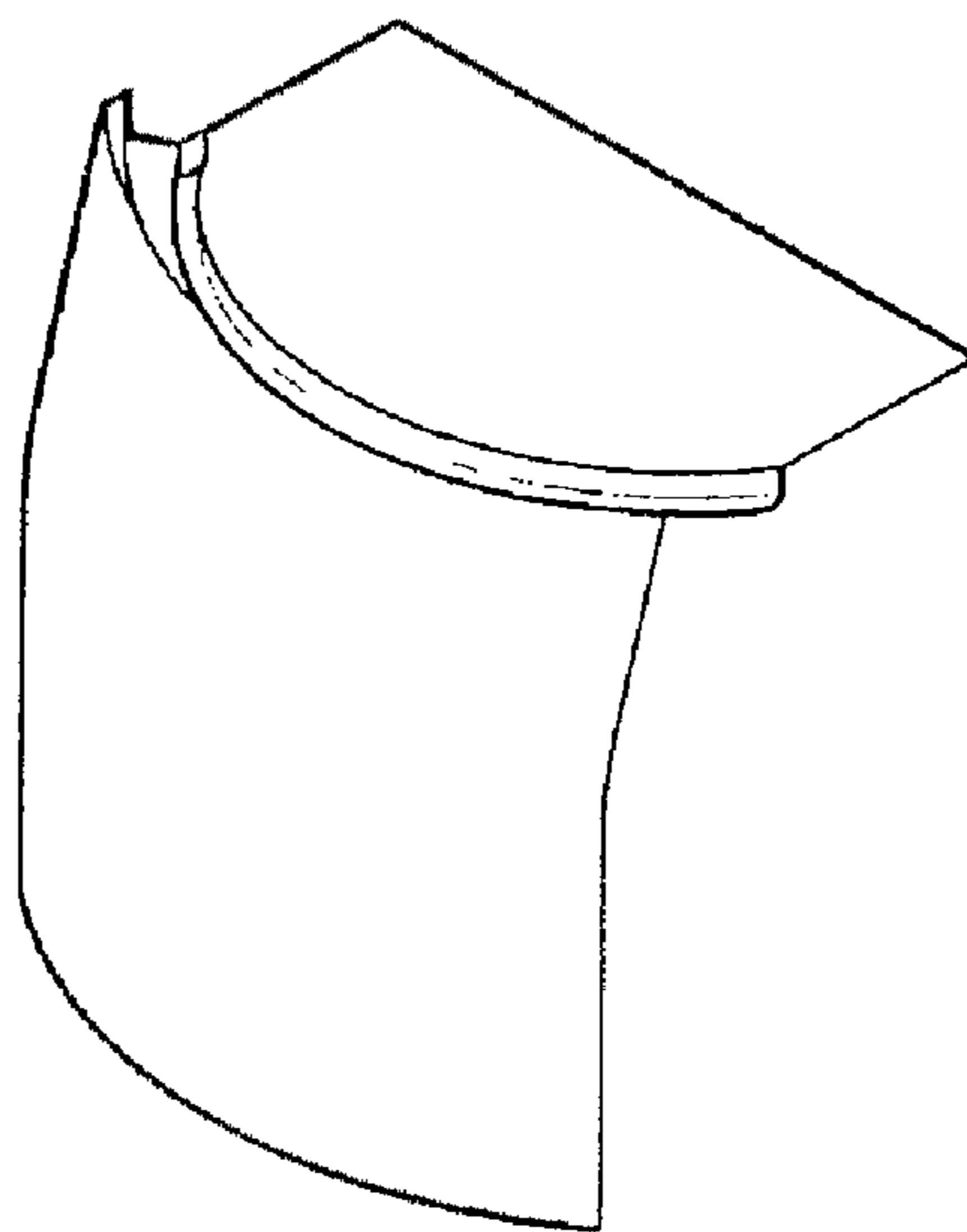

FIG. 2

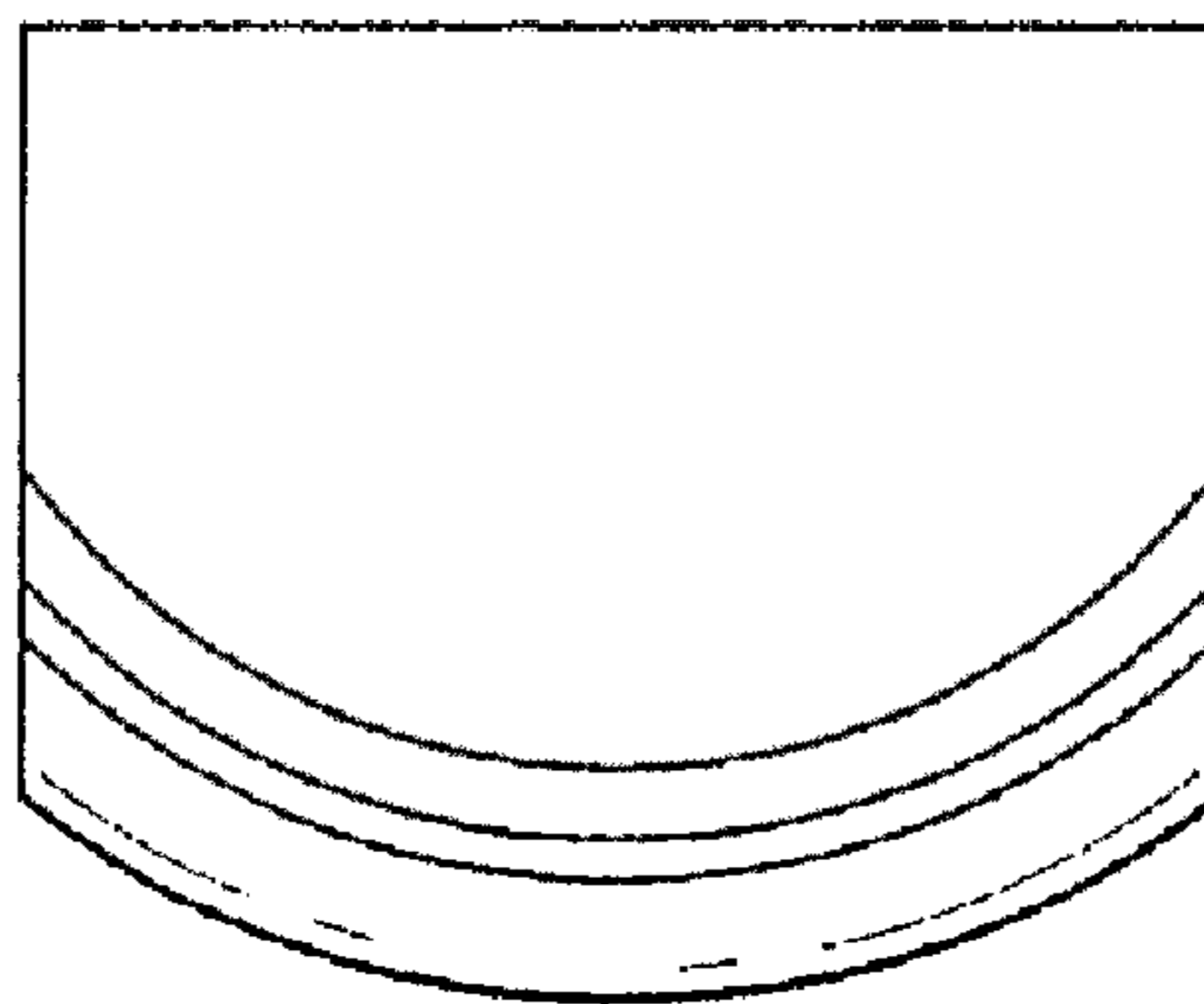

FIG. 3

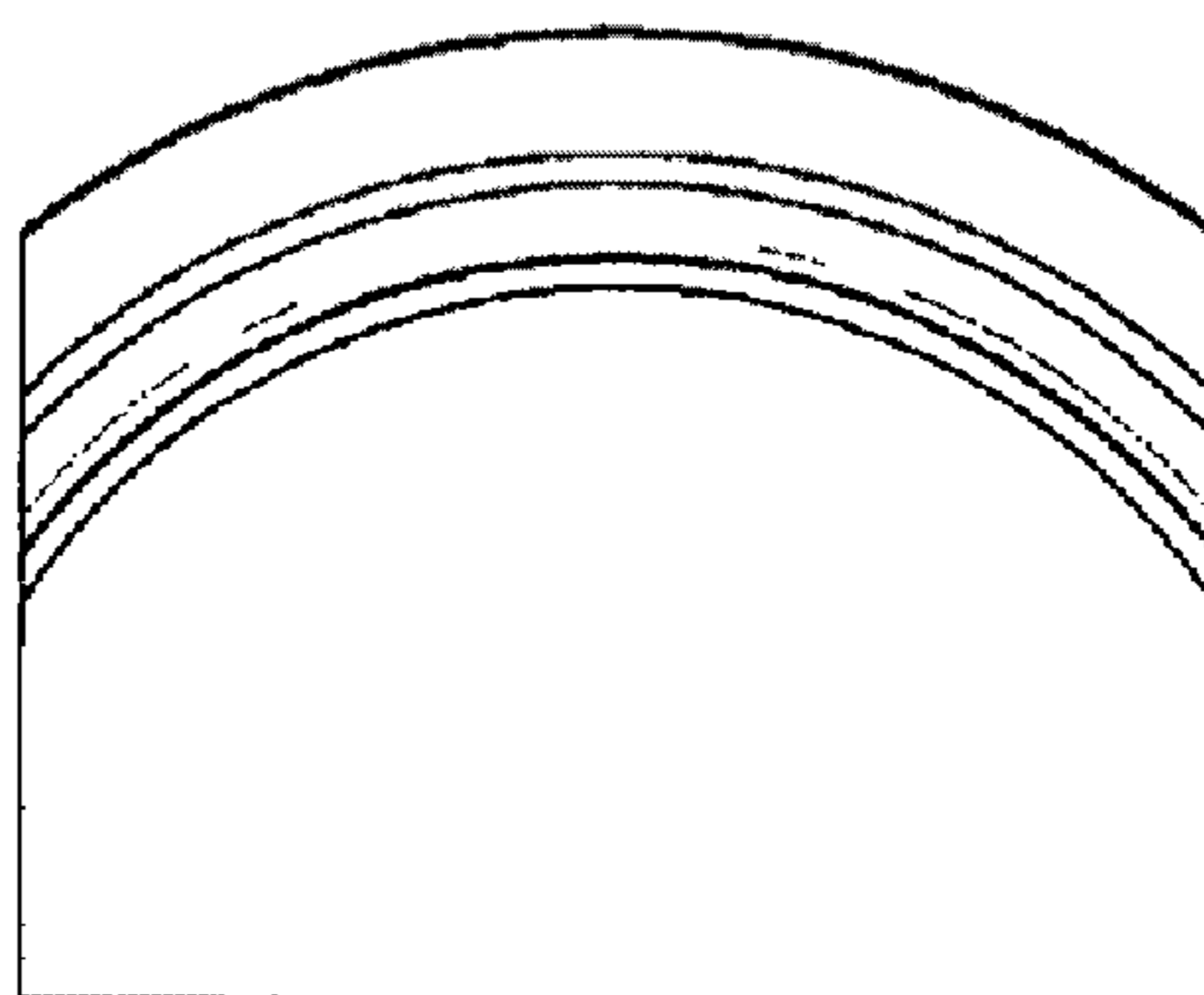

FIG. 4

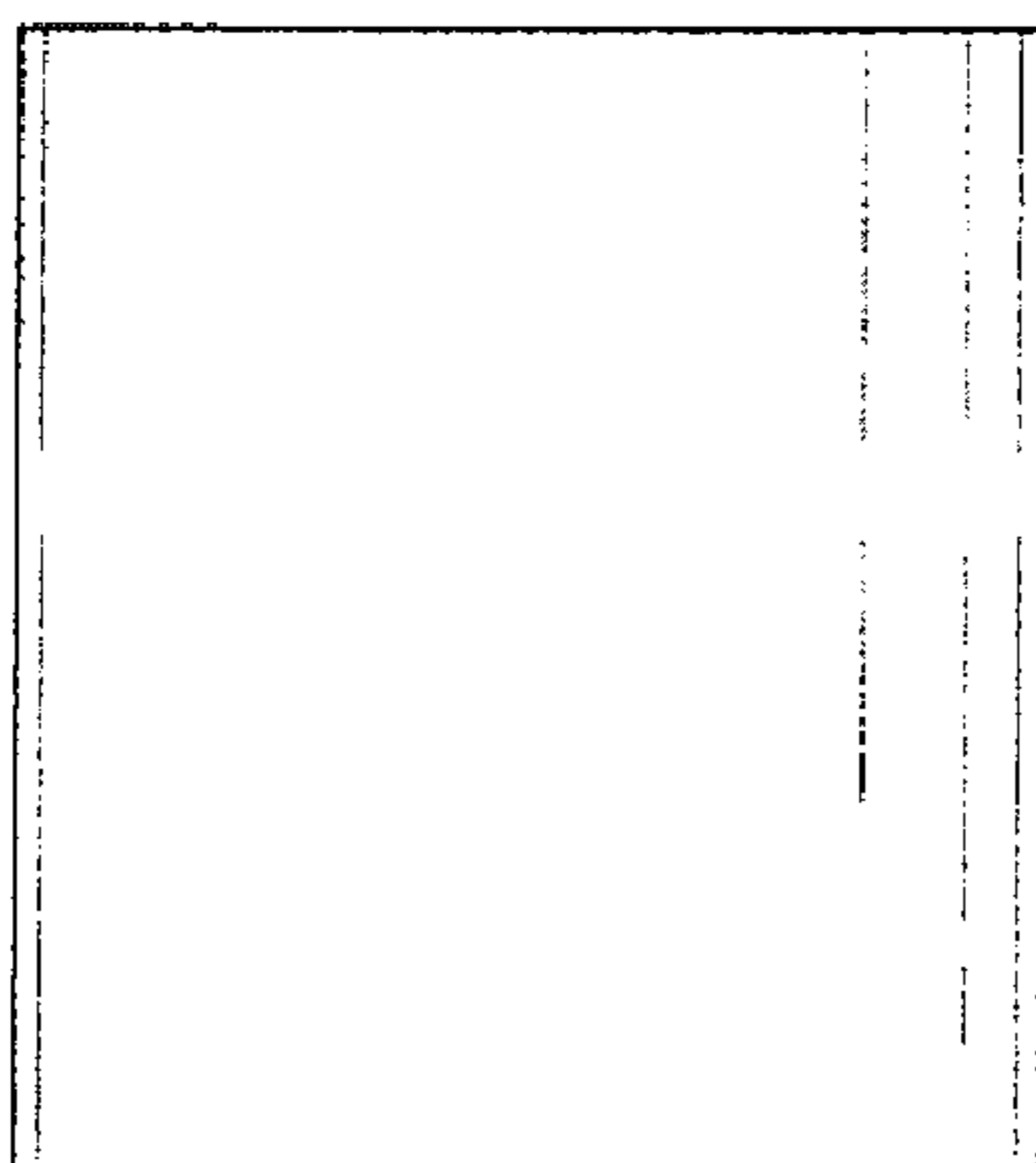

FIG. 5

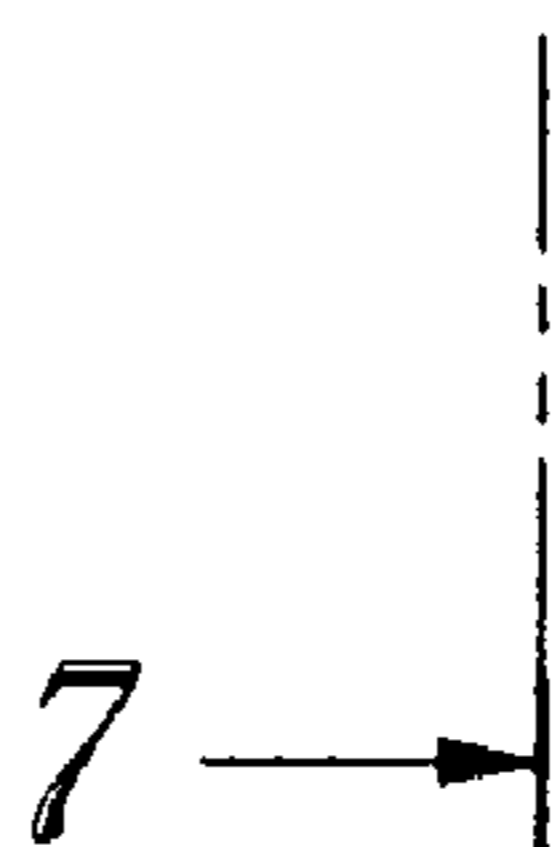
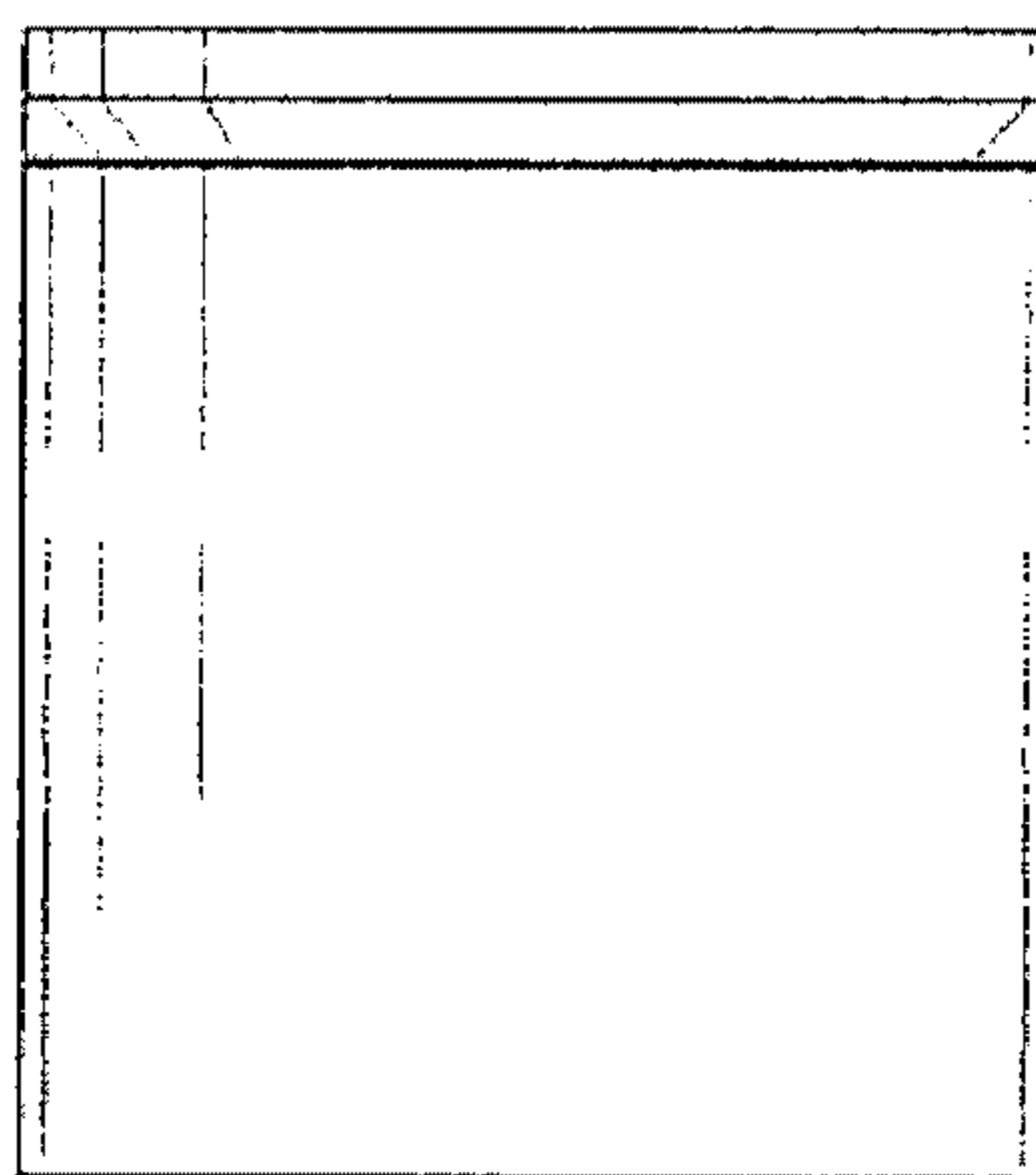

FIG. 6

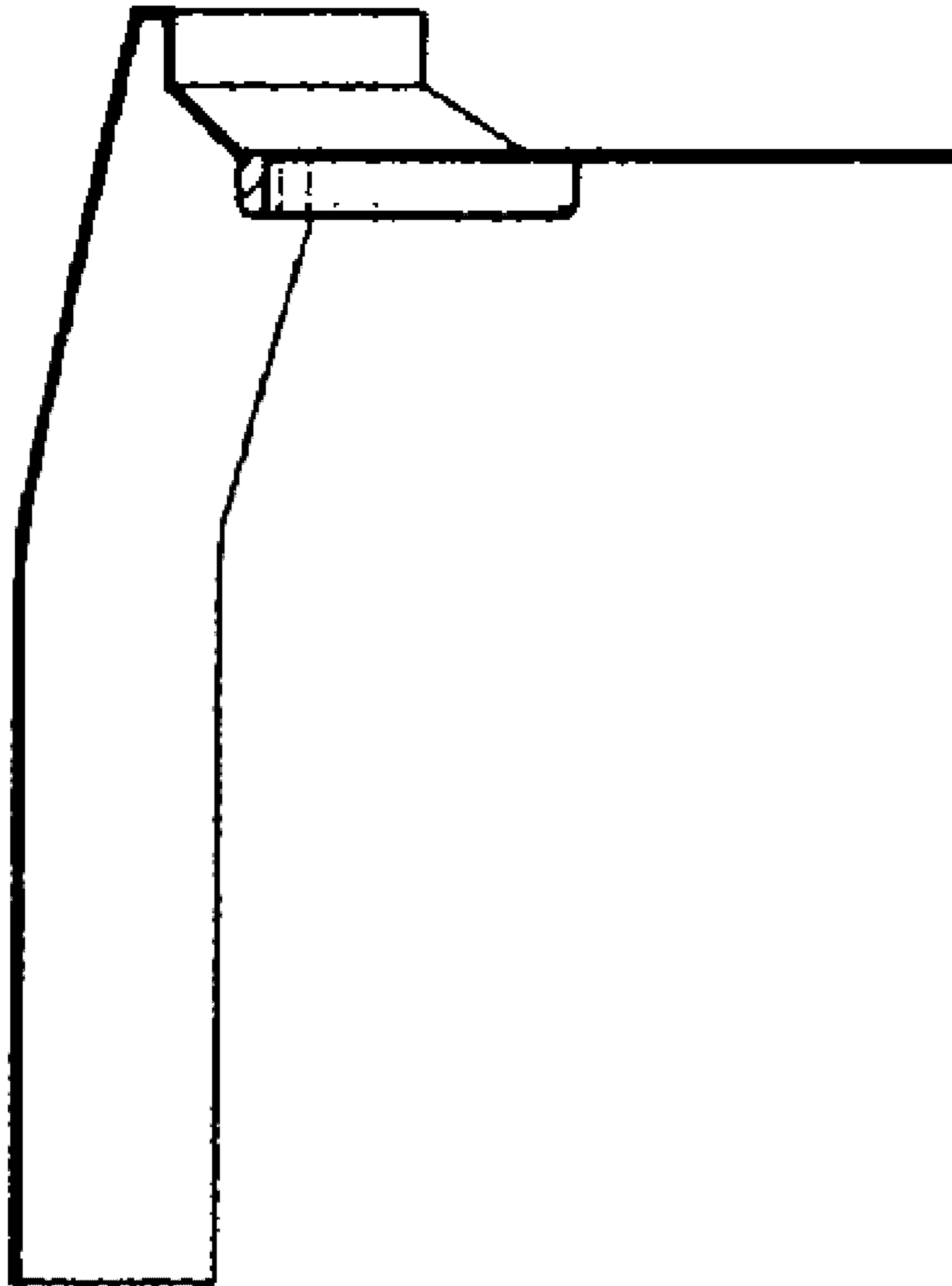

FIG. 7

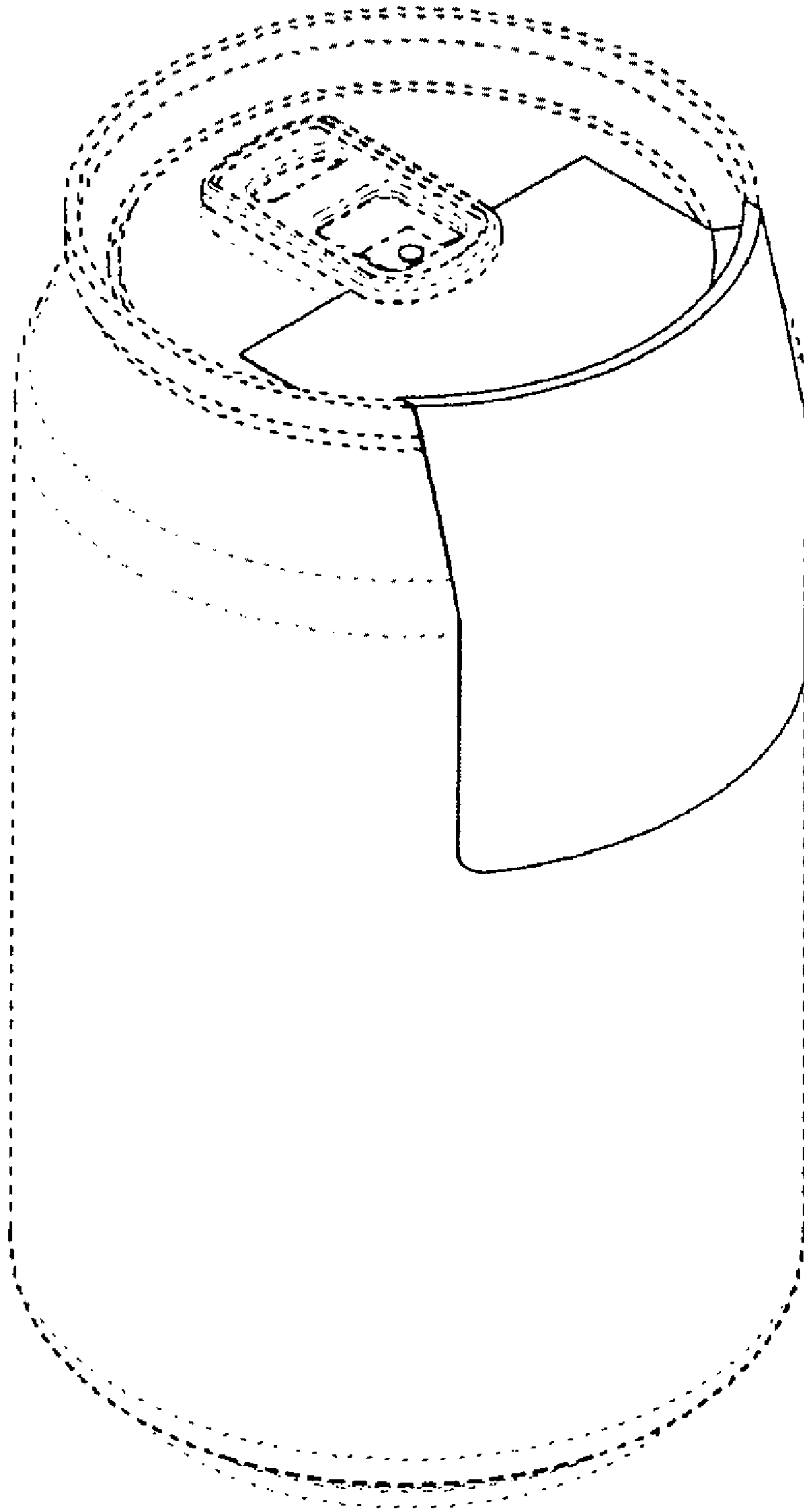

FIG. 8

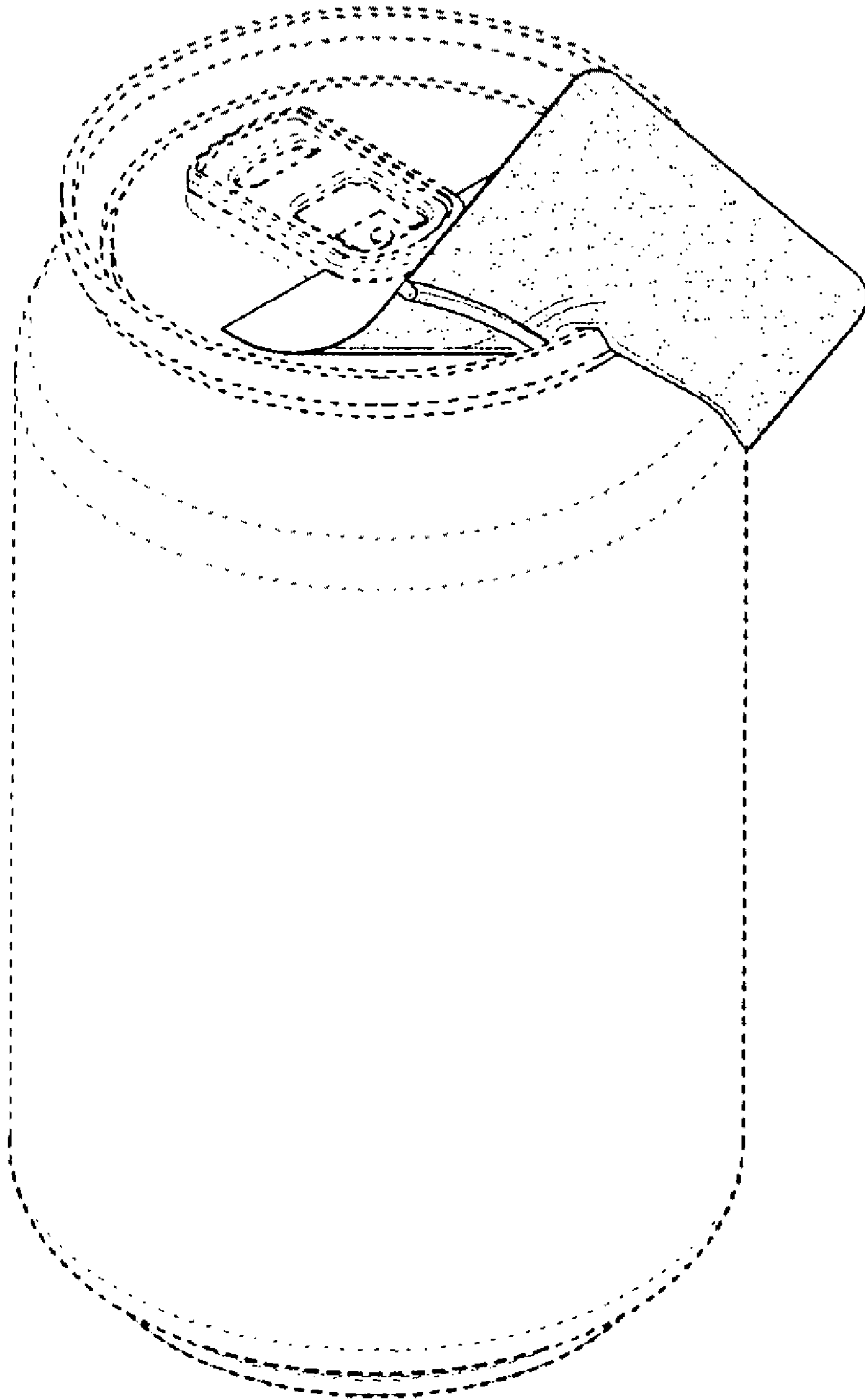

FIG. 9

UNITED STATES PATENT AND TRADEMARK OFFICE
CERTIFICATE OF CORRECTION

PATENT NO. : D676,317 S
APPLICATION NO. : 29/409293
DATED : February 19, 2013
INVENTOR(S) : Francois Stefanus De Klerk

Page 1 of 1

It is certified that error appears in the above-identified patent and that said Letters Patent is hereby corrected as shown below:

On the Title Page

In column 2, line 18, delete “container;” and insert --container.--, therefor

In column 2, line 19, after “container;”, delete “and;”, therefor

Signed and Sealed this
Third Day of September, 2013



Teresa Stanek Rea
Acting Director of the United States Patent and Trademark Office