



US00D676239S

(12) **United States Design Patent**  
**Benoit et al.**

(10) **Patent No.:** **US D676,239 S**  
(45) **Date of Patent:** **\*\* Feb. 19, 2013**

(54) **CONTAINER**

(75) Inventors: **Erica Yvette Benoit**, Marietta, GA (US);  
**Eddy Benoit, Jr.**, Marietta, GA (US);  
**David Scott Rowley**, Powder Springs,  
GA (US); **Zachary Adam Griggs**,  
Atlanta, GA (US)

(73) Assignee: **Fflox, Inc.**, Atlanta, GA (US)

(\*\*) Term: **14 Years**

(21) Appl. No.: **29/413,348**

(22) Filed: **Feb. 14, 2012**

(51) **LOC (9) Cl.** ..... **03-01**

(52) **U.S. Cl.** ..... **D3/294**

(58) **Field of Classification Search** ..... D3/293-295,  
D3/273, 302, 905, 276, 283, 201; 206/349,  
206/372; D7/629; D30/133; D9/420; 220/523,  
220/4.21, 4.22

See application file for complete search history.

(56) **References Cited**

U.S. PATENT DOCUMENTS

D235,622 S \* 7/1975 Herring ..... D3/295  
D252,115 S \* 6/1979 Herring ..... D3/295

D592,398 S \* 5/2009 Roesler ..... D3/294  
D592,399 S \* 5/2009 Sage ..... D3/295  
D636,182 S \* 4/2011 Yang ..... D3/294  
D636,598 S \* 4/2011 Tseng et al. .... D3/294  
D661,897 S \* 6/2012 Kohler et al. .... D3/294  
8,220,625 B2 \* 7/2012 Michaels et al. .... 206/233

\* cited by examiner

*Primary Examiner* — Sheryl Lane

(74) *Attorney, Agent, or Firm* — DLA Piper LLP US

(57) **CLAIM**

We claim an ornamental design for a container, as shown and described herein.

**DESCRIPTION**

FIG. 1 is an open perspective view of the container.  
FIG. 2 is a front view thereof;  
FIG. 3 is a back view thereof;  
FIG. 4 is a right side view thereof;  
FIG. 5 is a left side view thereof;  
FIG. 6 is a top view thereof; and,  
FIG. 7 is a bottom view thereof.

Note that any broken line illustration of environmental structure in the drawing is not part of the design sought to be patented.

**1 Claim, 4 Drawing Sheets**

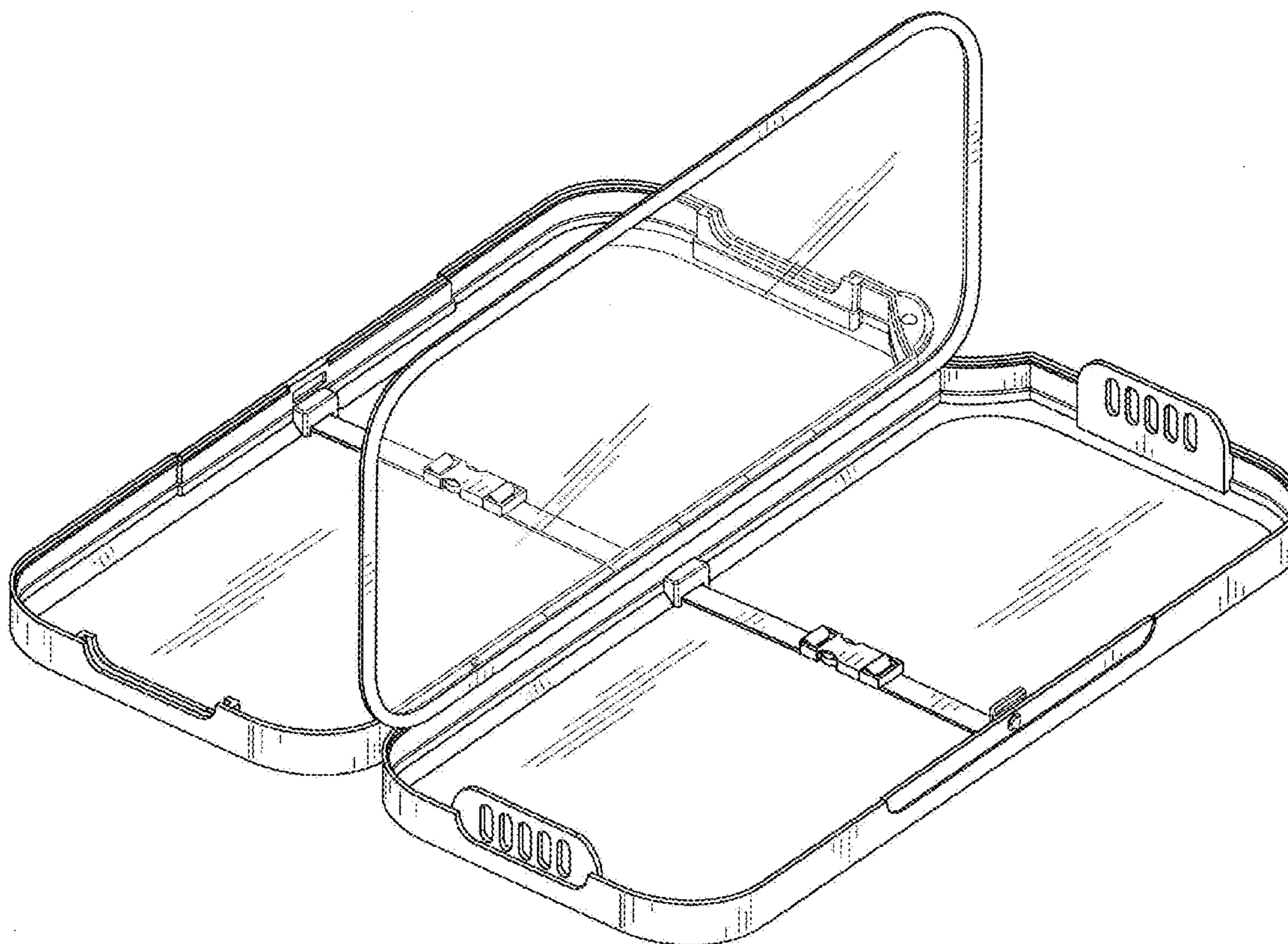

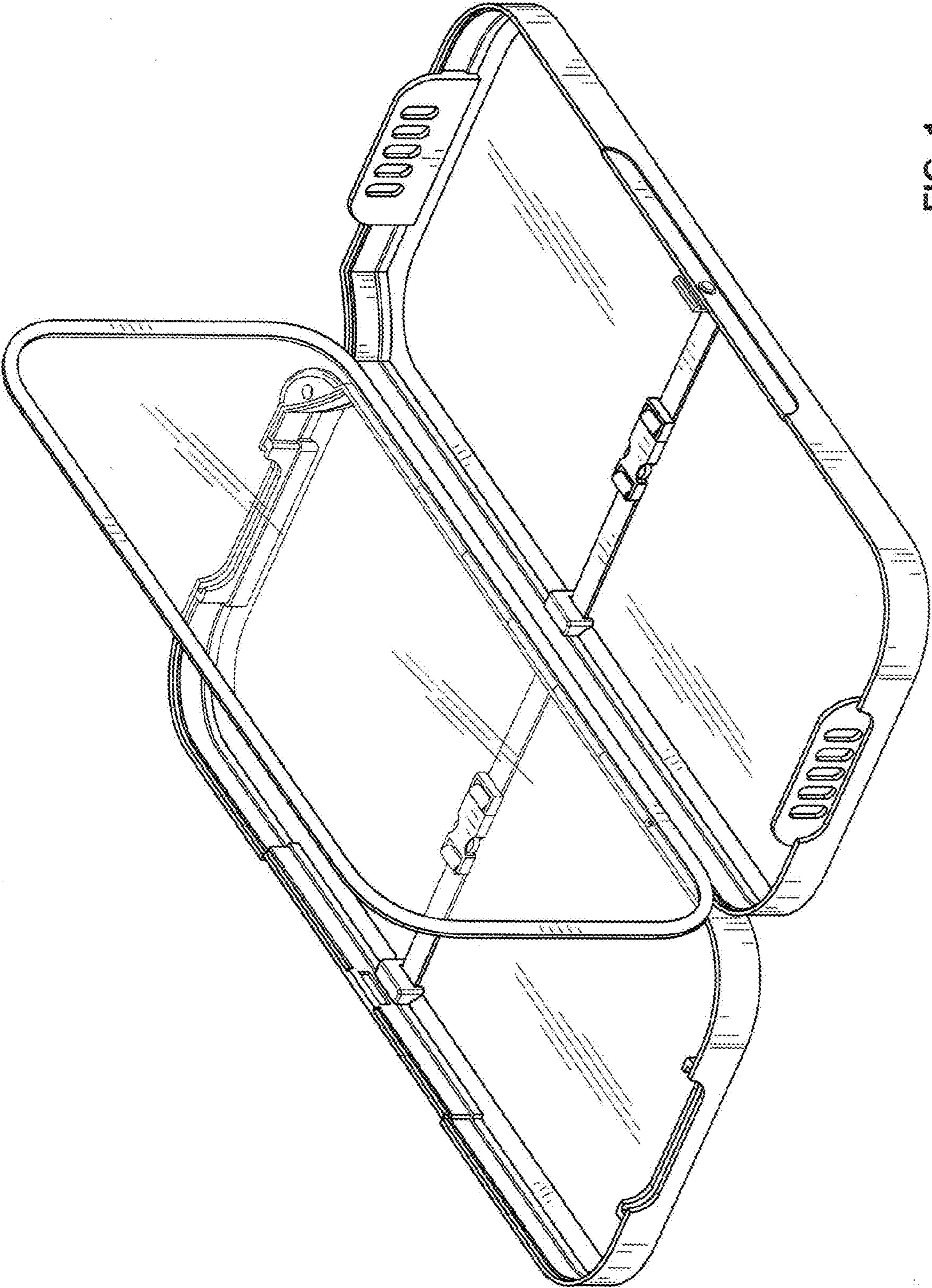

FIG. 1

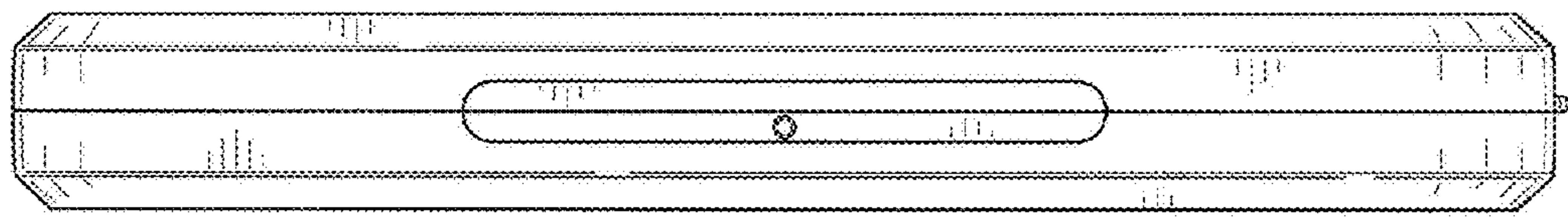

FIG. 2

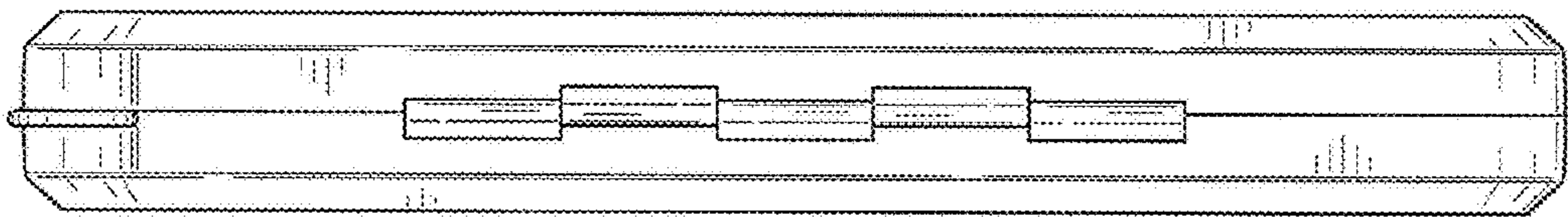

FIG. 3

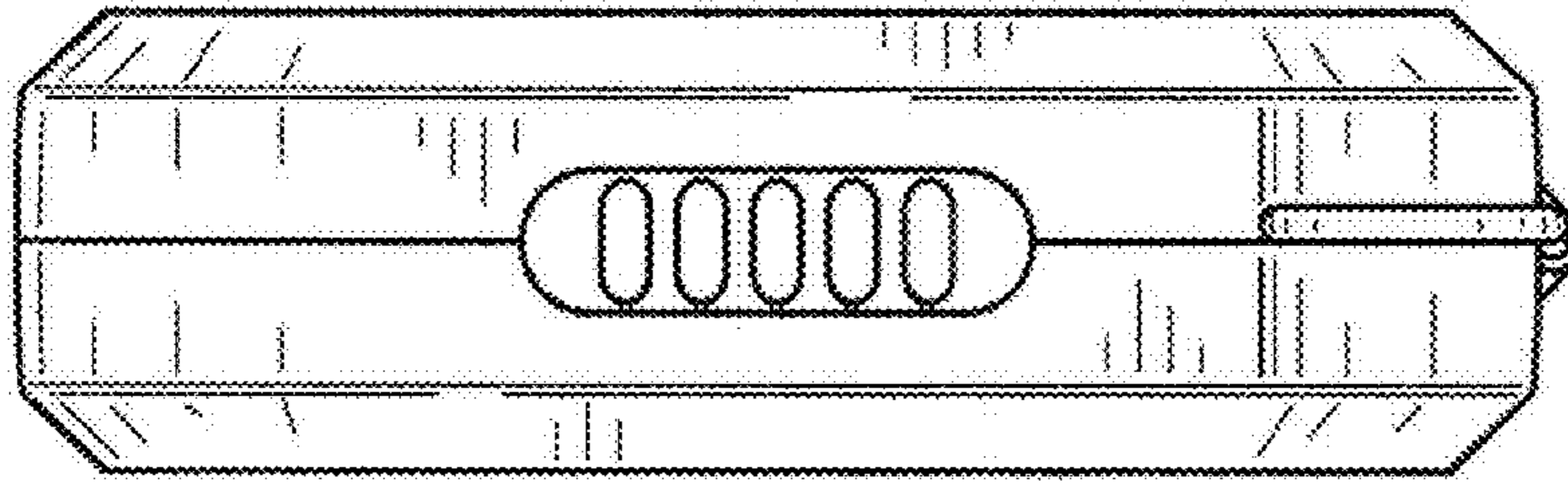

FIG. 4

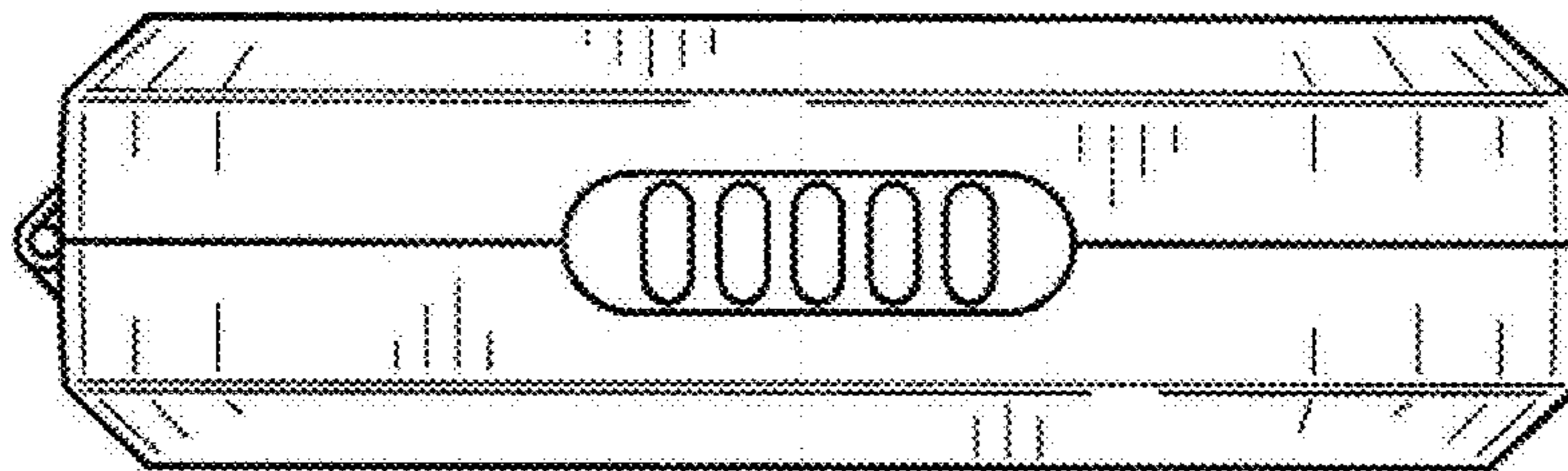

FIG. 5

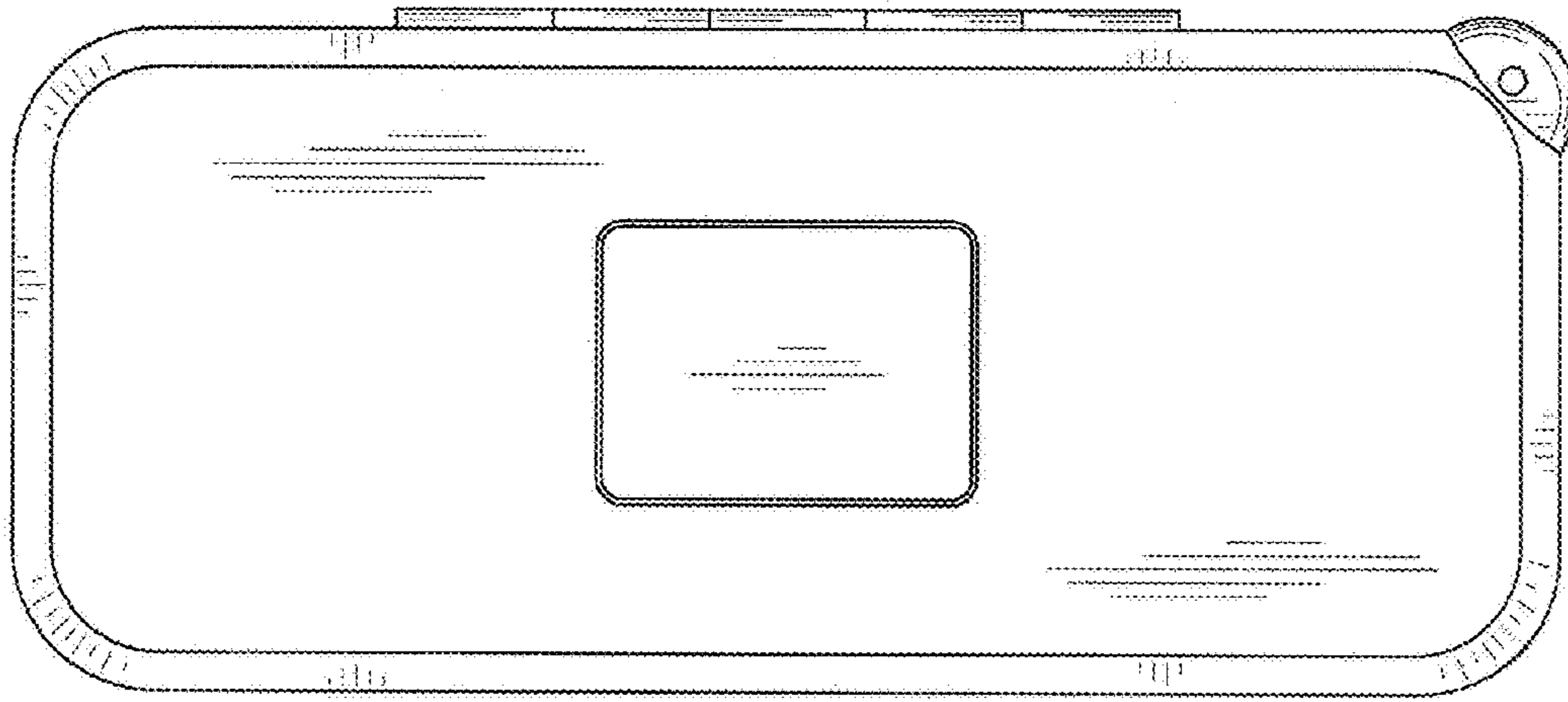

FIG. 6

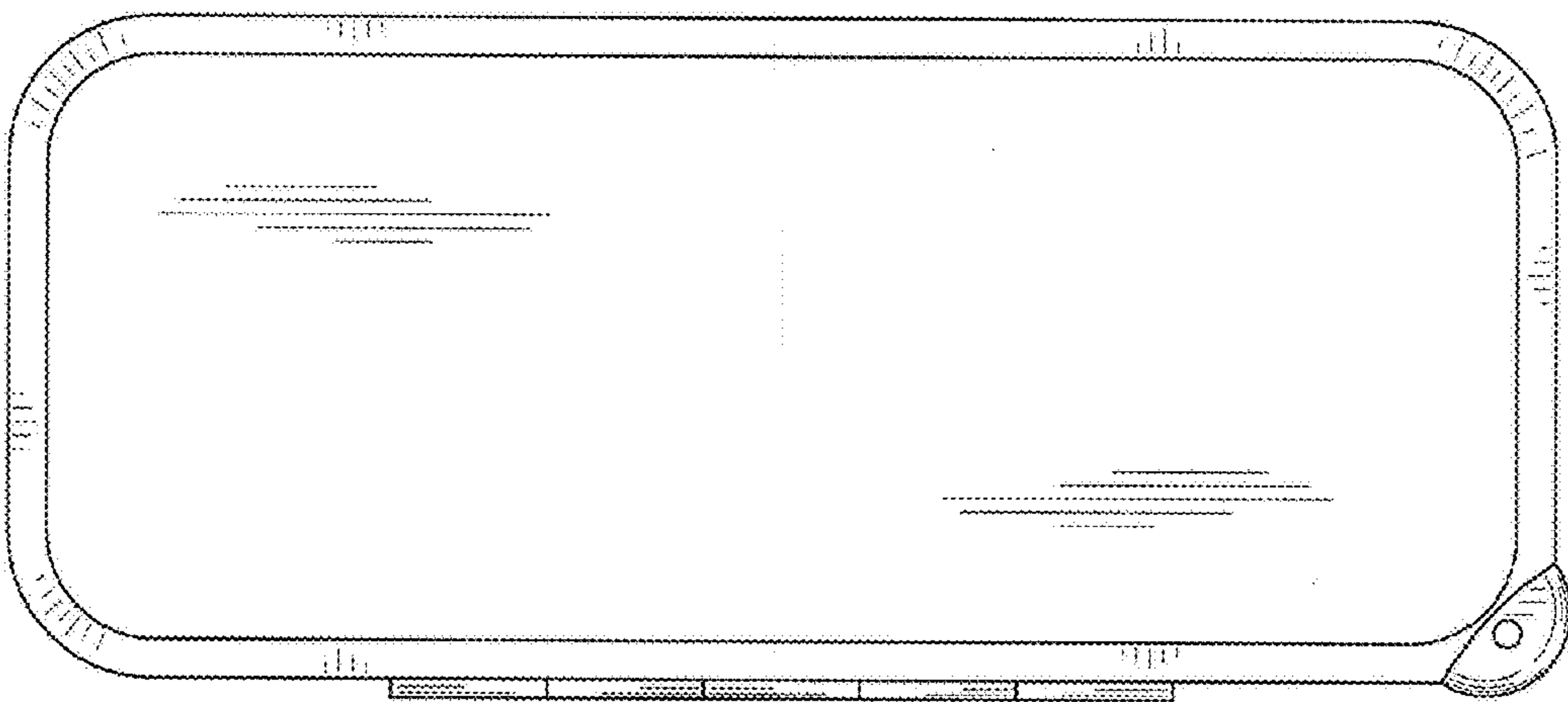

FIG. 7