



US00D676215S

(12) **United States Design Patent**
DeJong et al.

(10) **Patent No.:** **US D676,215 S**
(45) **Date of Patent:** **** Feb. 12, 2013**

(54) **ITEM SORTING DEVICE**

(76) Inventors: **Steve Eugene DeJong**, Maple Grove, MN (US); **Dennis DeJong**, Maple Grove, MN (US); **Chad Culbertson**, Zimmerman, MN (US)

(**) Term: **14 Years**

(21) Appl. No.: **29/417,730**

(22) Filed: **Apr. 7, 2012**

(51) **LOC (9) Cl.** **99-00**

(52) **U.S. Cl.** **D99/34**

(58) **Field of Classification Search** D99/28, D99/34, 35, 36, 37, 43, 99; D18/3.1, 3.2, D18/3.3, 12.1; 206/0.8, 0.81, 0.815, 0.83, 206/0.84; 53/212, 213; 232/1 D, 5, 4 R; 453/3, 6, 7, 8, 10, 11, 12, 58, 59, 60, 61, 453/62, 63

See application file for complete search history.

(56) **References Cited**

U.S. PATENT DOCUMENTS

D812,327	2/1906	Cranner	
1,457,261 A *	5/1923	Mathewes	53/254
D159,425 S	7/1950	Leese	
3,085,378 A *	4/1963	Howard	53/254
3,338,250 A *	8/1967	Mehelich	453/9
3,367,346 A	2/1968	Gdanski	
3,410,385 A *	11/1968	Freet et al.	194/232
D226,119 S	1/1973	Andamasaris	
D241,866 S	10/1976	Miyazaki	
4,153,197 A *	5/1979	Hall	232/5
D285,139 S	8/1986	Miles	
D289,218 S	4/1987	Divnick	
D296,029 S	5/1988	Knox	
4,871,055 A	10/1989	Poythress et al.	
5,277,651 A	1/1994	Rasmussen et al.	
D347,929 S *	6/1994	Perkitny	D99/34
5,474,496 A *	12/1995	Perkitny	453/9

D378,464 S *	3/1997	Perkitny	D99/34
D390,684 S	2/1998	Yeh	
D393,530 S *	4/1998	Perkitny	D99/34
5,827,117 A *	10/1998	Naas	453/9
D424,780 S	5/2000	Swaine	
D425,684 S *	5/2000	Henry	D99/34
6,099,401 A *	8/2000	Perkitny	453/9
D443,126 S	5/2001	Reviea et al.	
D443,292 S	6/2001	Nottingham et al.	
D445,990 S *	7/2001	Knox et al.	D99/34
D446,380 S	8/2001	Knox, Jr.	
D453,407 S *	2/2002	Lim	D99/34
D460,102 S *	7/2002	Perkitny	D18/3.1
D477,452 S	7/2003	Chia	
D481,519 S *	10/2003	Lee	D99/34
D519,259 S *	4/2006	Lee et al.	D99/34
D634,095 S *	3/2011	Messner	D99/34
D648,095 S *	11/2011	Fernandez et al.	D99/34
2004/0094434 A1 *	5/2004	Ahmed	206/83

* cited by examiner

Primary Examiner — Elizabeth J Oswecki

(74) *Attorney, Agent, or Firm* — QuickPatents; Kevin Prince

(57) **CLAIM**

We claim the ornamental design for an item sorting device, as shown and described.

DESCRIPTION

FIG. 1 is a perspective view of an item sorting device, showing our new design;
FIG. 2 is a front elevational view thereof;
FIG. 3 is a right-side elevational view thereof;
FIG. 4 is a rear elevational view thereof;
FIG. 5 is a left-side elevational view thereof;
FIG. 6 is a top plan view thereof; and,
FIG. 7 is a bottom plan view thereof.
The broken lines showing a logo in FIGS. 3-5 and fasteners in FIGS. 1, 2 and 7 depict environmental matter and form no part of the claimed design.

1 Claim, 3 Drawing Sheets

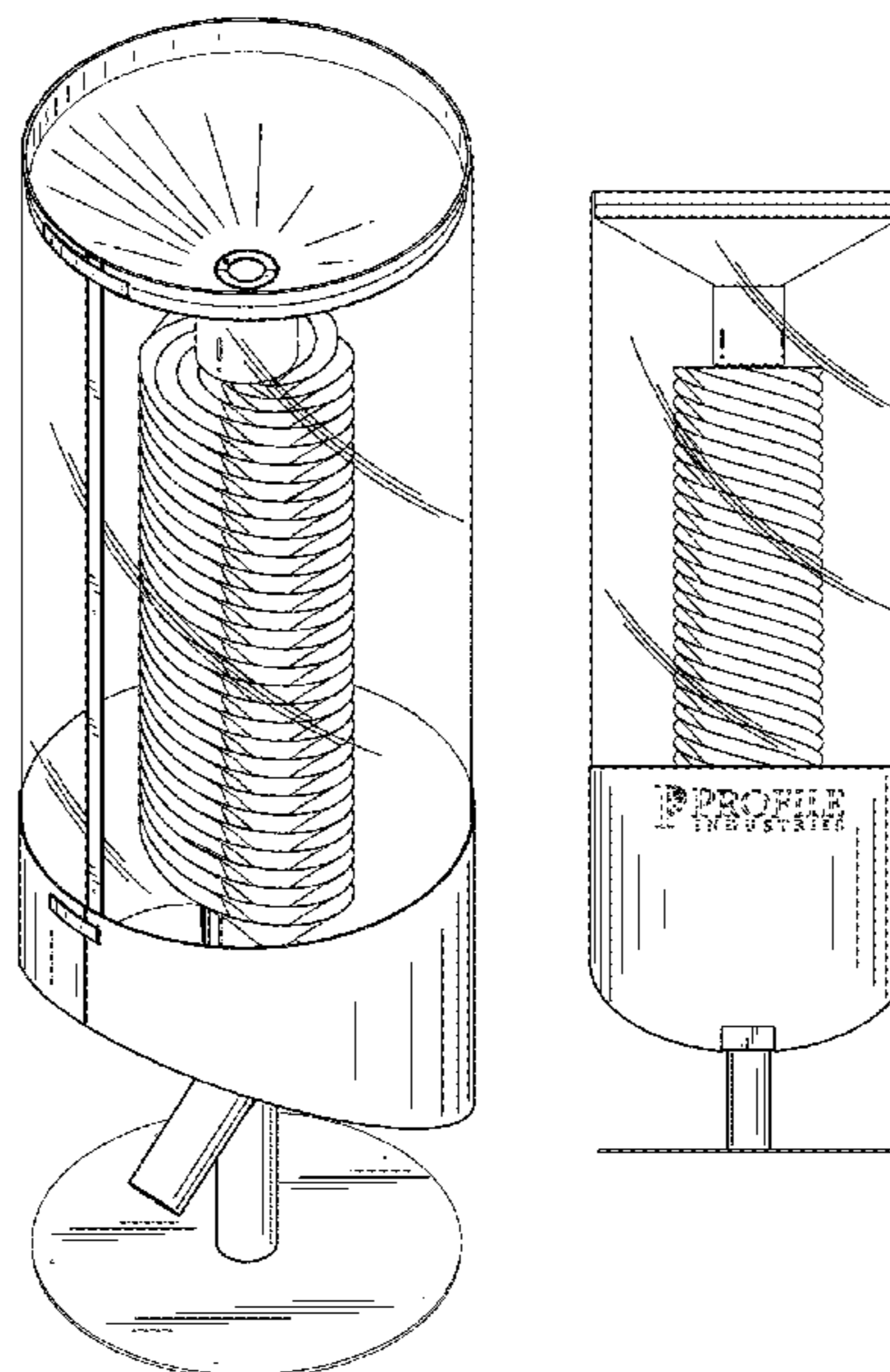

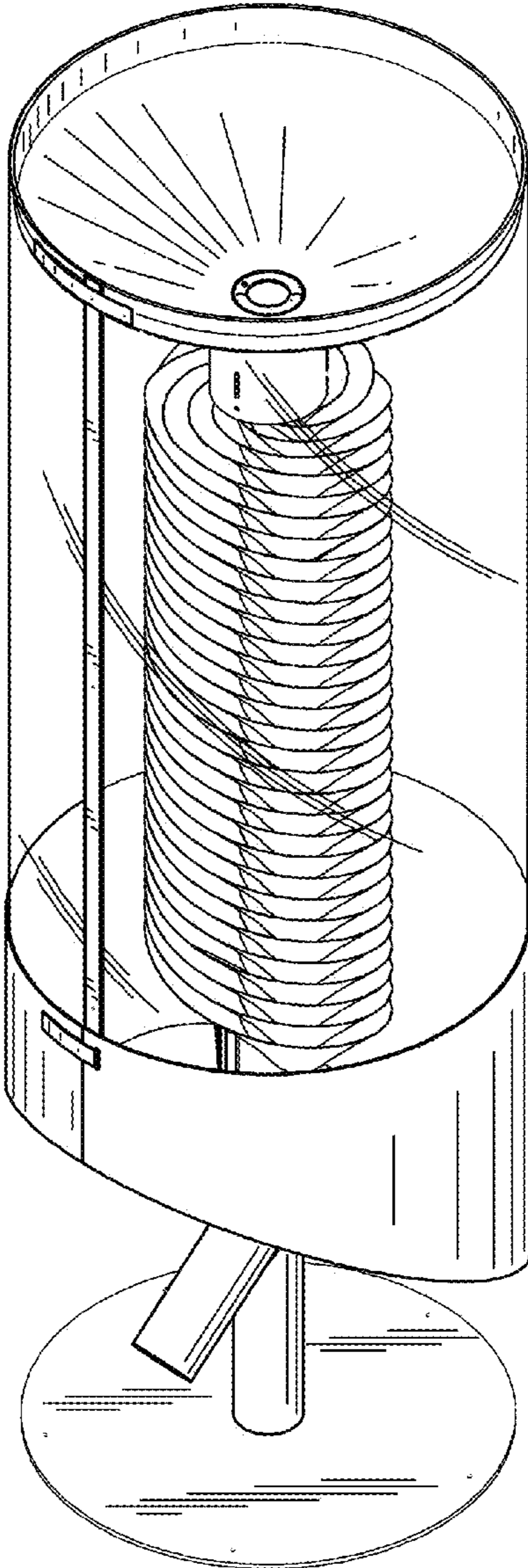

FIG. 1

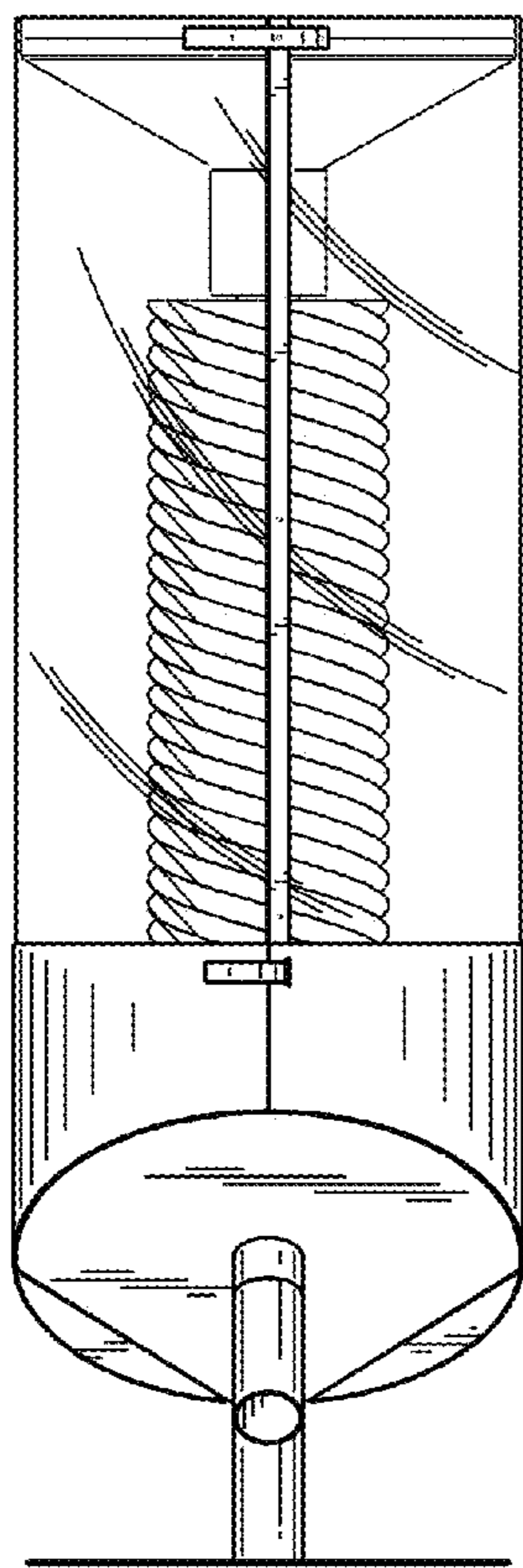

FIG. 2

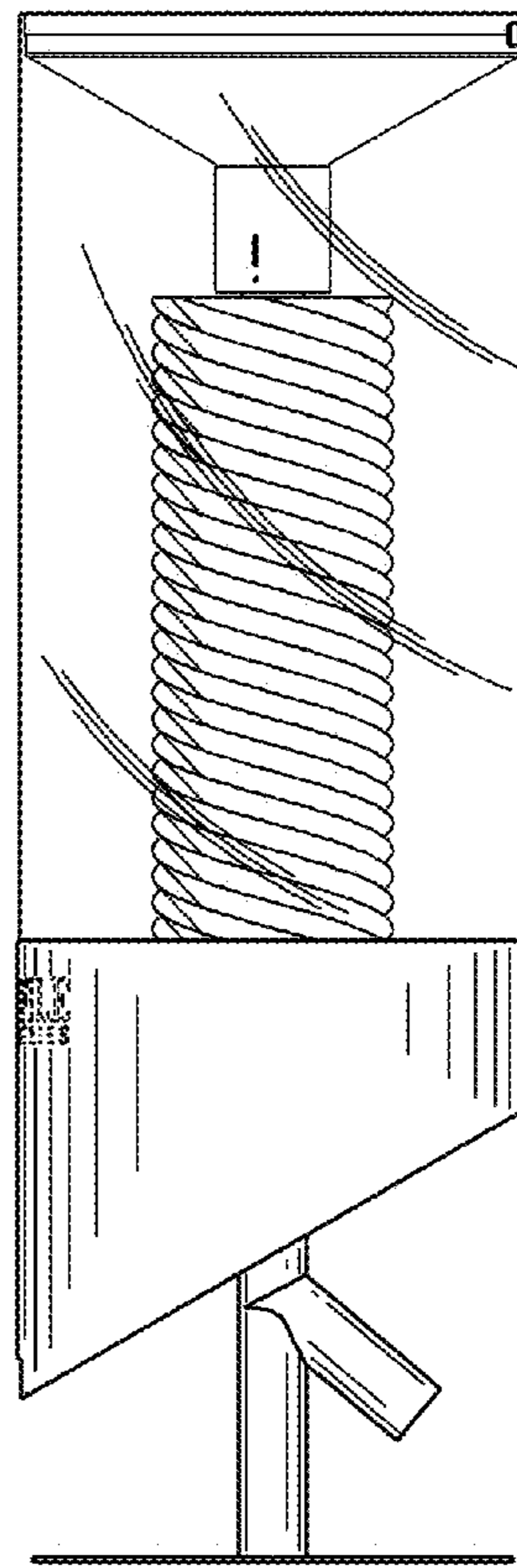

FIG. 3

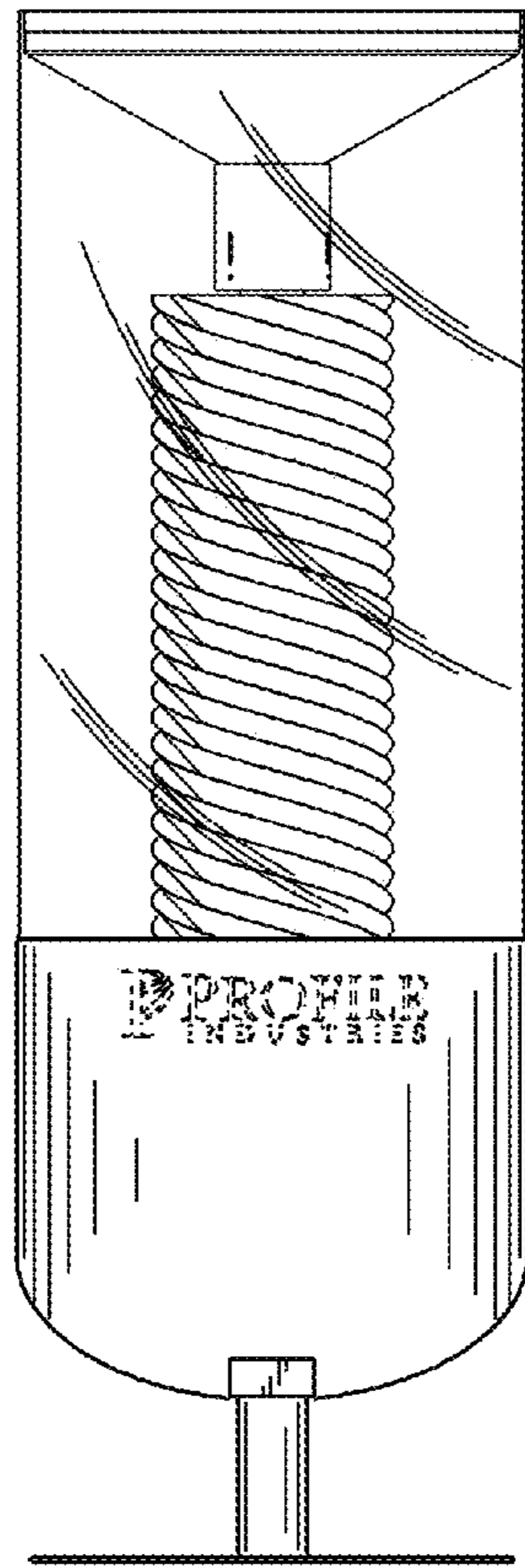

FIG. 4

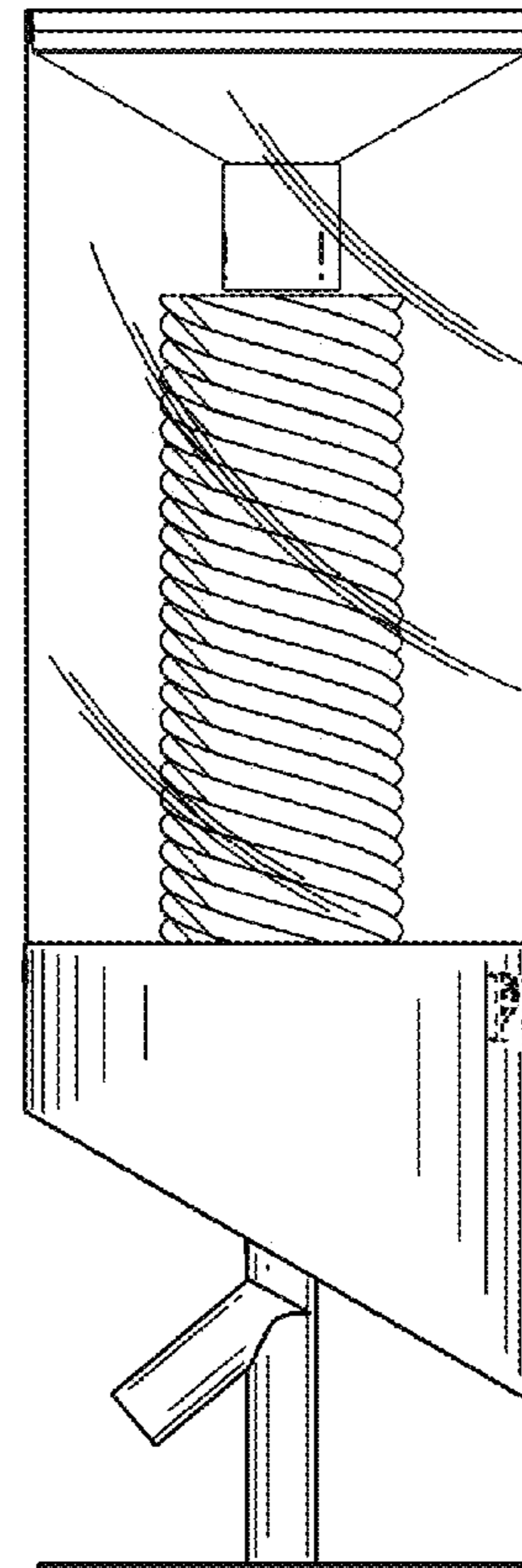

FIG. 5

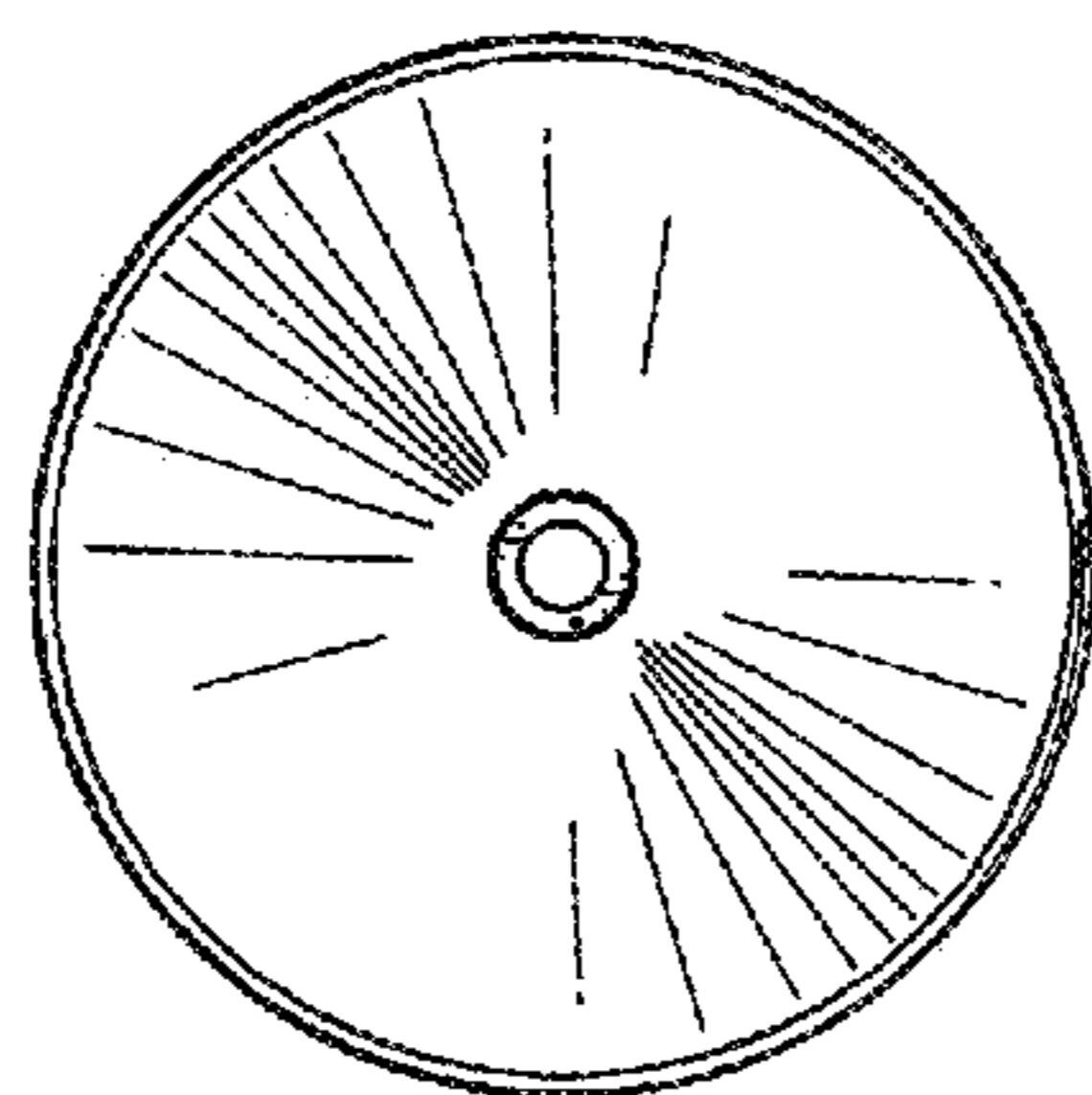

FIG. 6

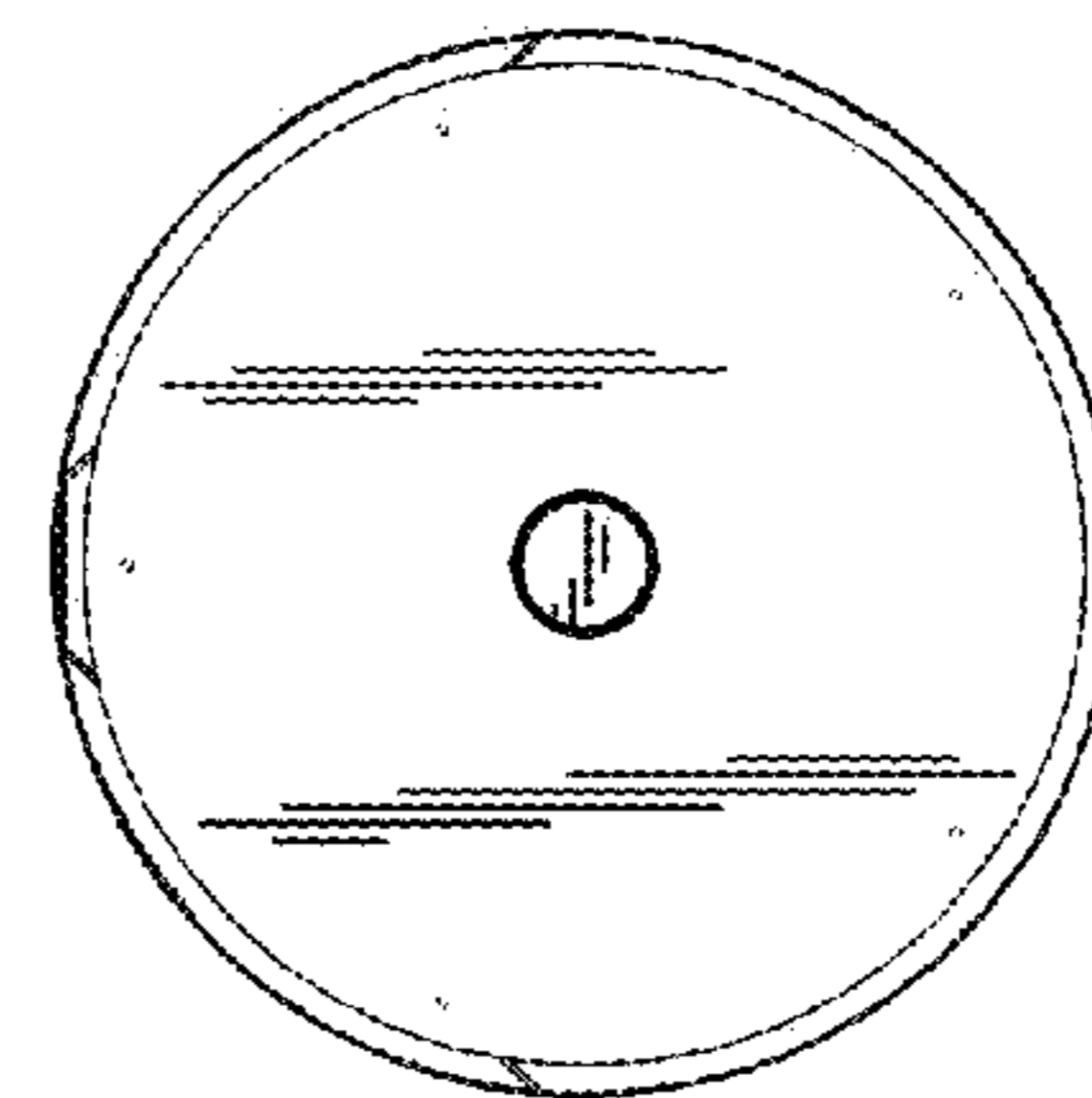

FIG. 7