



US00D676115S

(12) **United States Design Patent**
Lord

(10) **Patent No.:** **US D676,115 S**
(45) **Date of Patent:** **** Feb. 12, 2013**

(54) **FAUCET HANDLE**

(75) Inventor: **Judd Lord**, Fishers, IN (US)

(73) Assignee: **Masco Corporation of Indiana**,
Indianapolis, IN (US)

(**) Term: **14 Years**

(21) Appl. No.: **29/417,958**

(22) Filed: **Apr. 11, 2012**

(51) **LOC (9) Cl.** **23-01**

(52) **U.S. Cl.** **D23/252**

(58) **Field of Classification Search** D23/238-243,
D23/250, 252, 254, 249, 245; 4/675-678;
137/801

See application file for complete search history.

(56) **References Cited**

U.S. PATENT DOCUMENTS

D541,906 S * 5/2007 Qing D23/238
D579,521 S * 10/2008 Kulig D23/238
D602,574 S * 10/2009 Downey D23/252

D664,242 S * 7/2012 Gao et al. D23/252

* cited by examiner

Primary Examiner — Robert Delehanty

(74) *Attorney, Agent, or Firm* — Edgar A. Zarins; Nirav D. Parikh; Lora J. Graentzdoerffer

(57) **CLAIM**

The ornamental design for a faucet handle, as shown and described.

DESCRIPTION

FIG. 1 is a perspective view of a faucet handle showing my new design;

FIG. 2 is a top plan view thereof;

FIG. 3 is a left side view thereof;

FIG. 4 is a right side view thereof;

FIG. 5 is a first end view thereof;

FIG. 6 is a second end view thereof; and,

FIG. 7 is a bottom view thereof.

The broken lines shown in the drawings are included for the purpose of illustrating a portion of the faucet handle that forms no part of the claimed design.

1 Claim, 1 Drawing Sheet

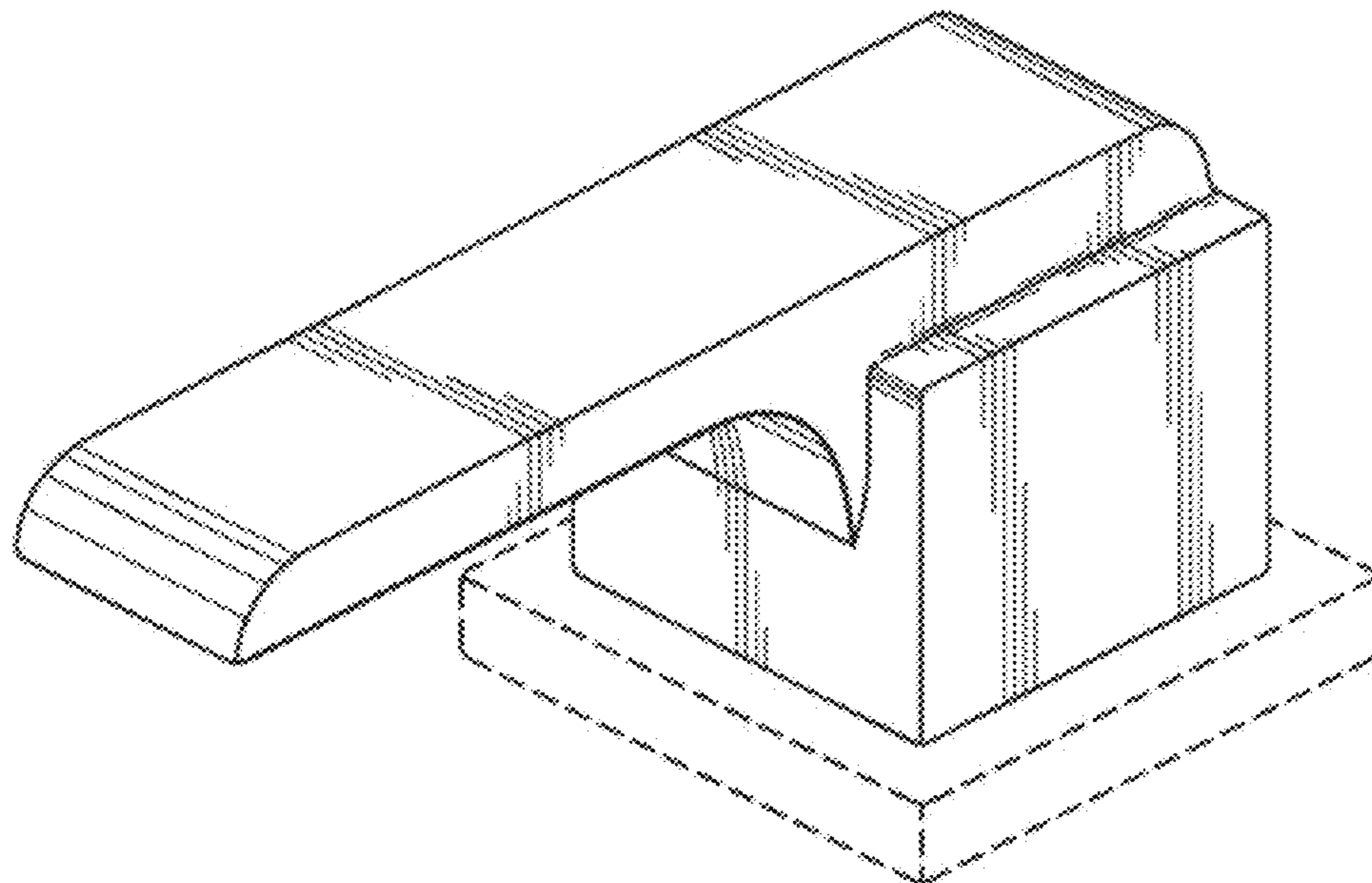

Fig-1

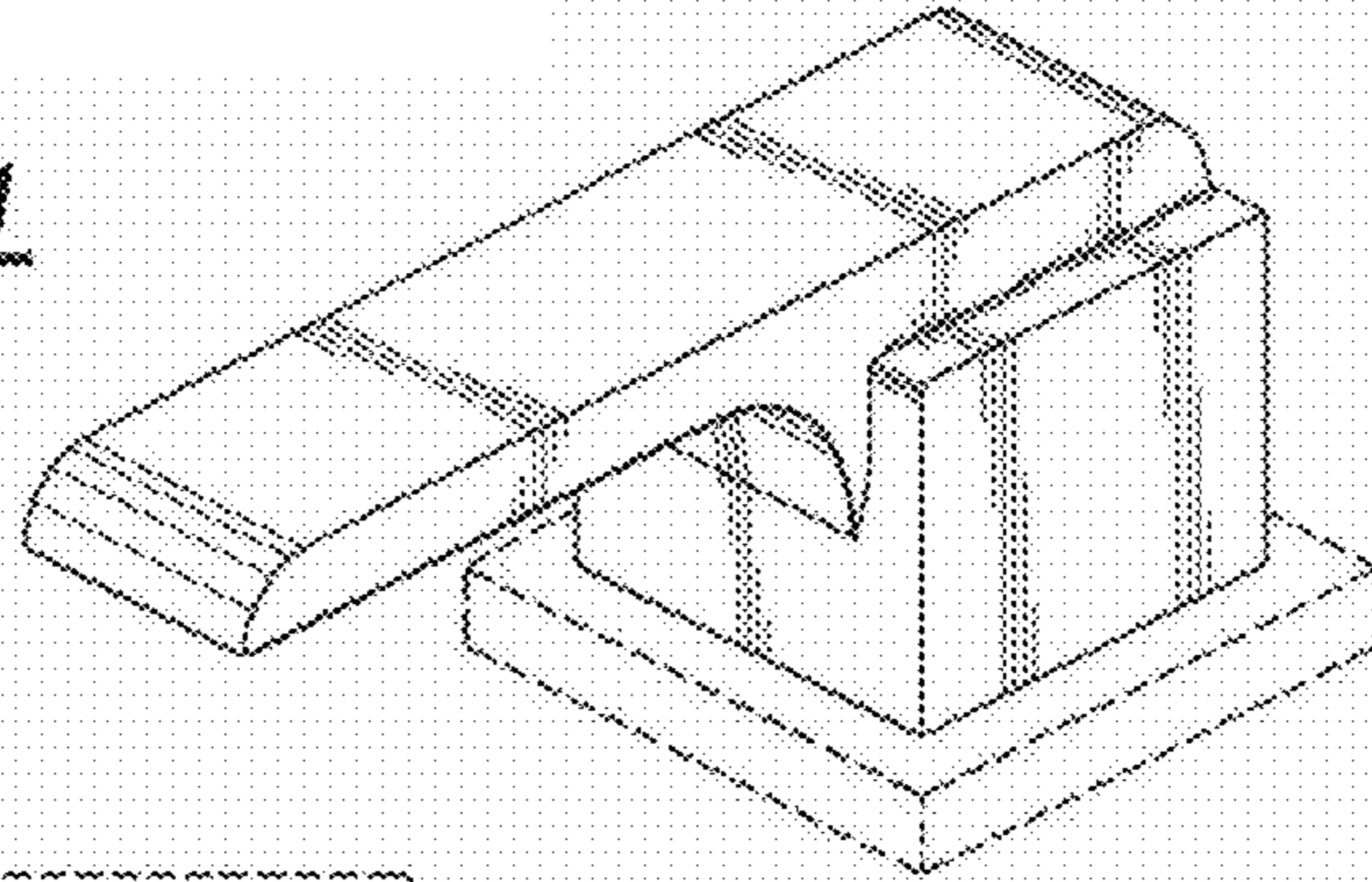

Fig-2

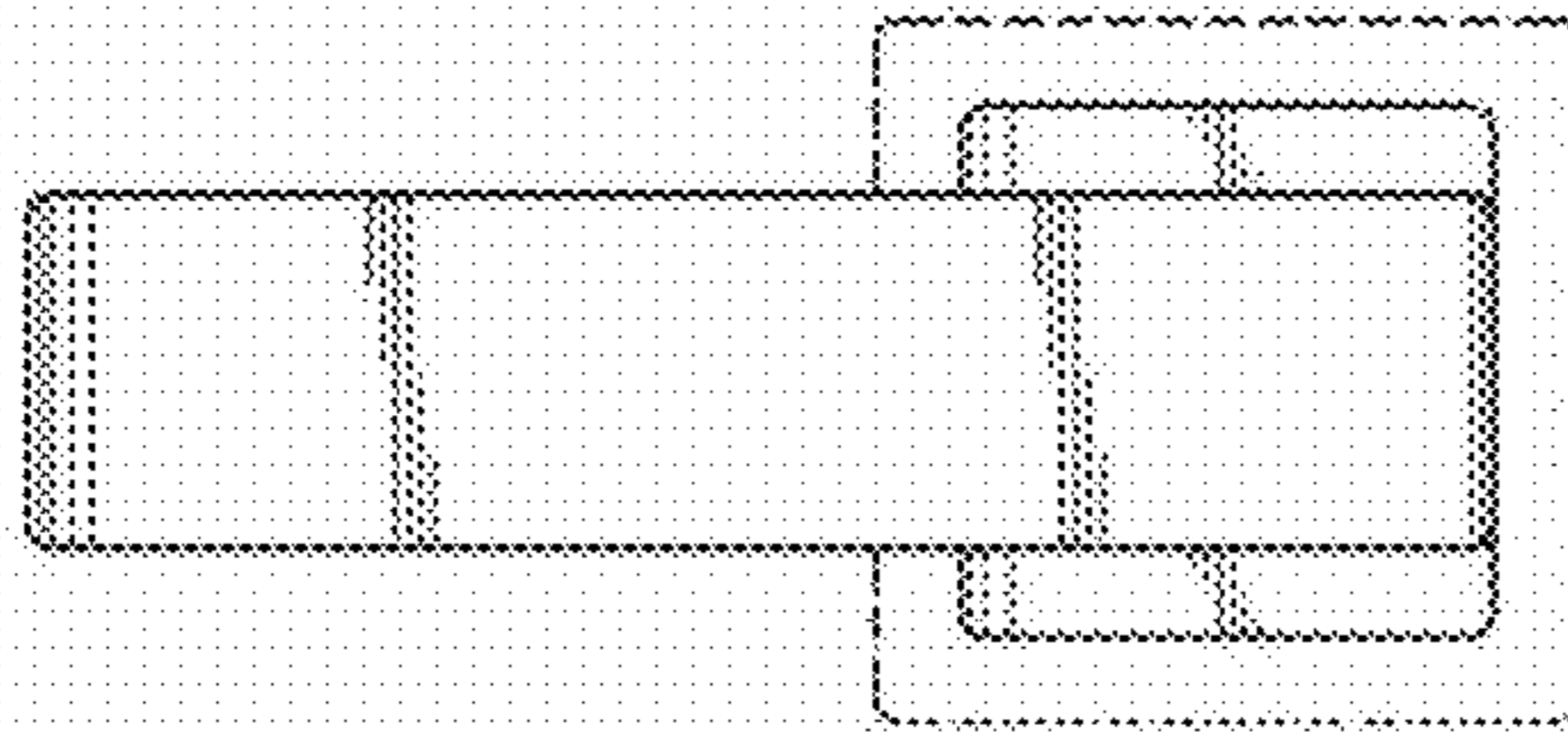

Fig-3

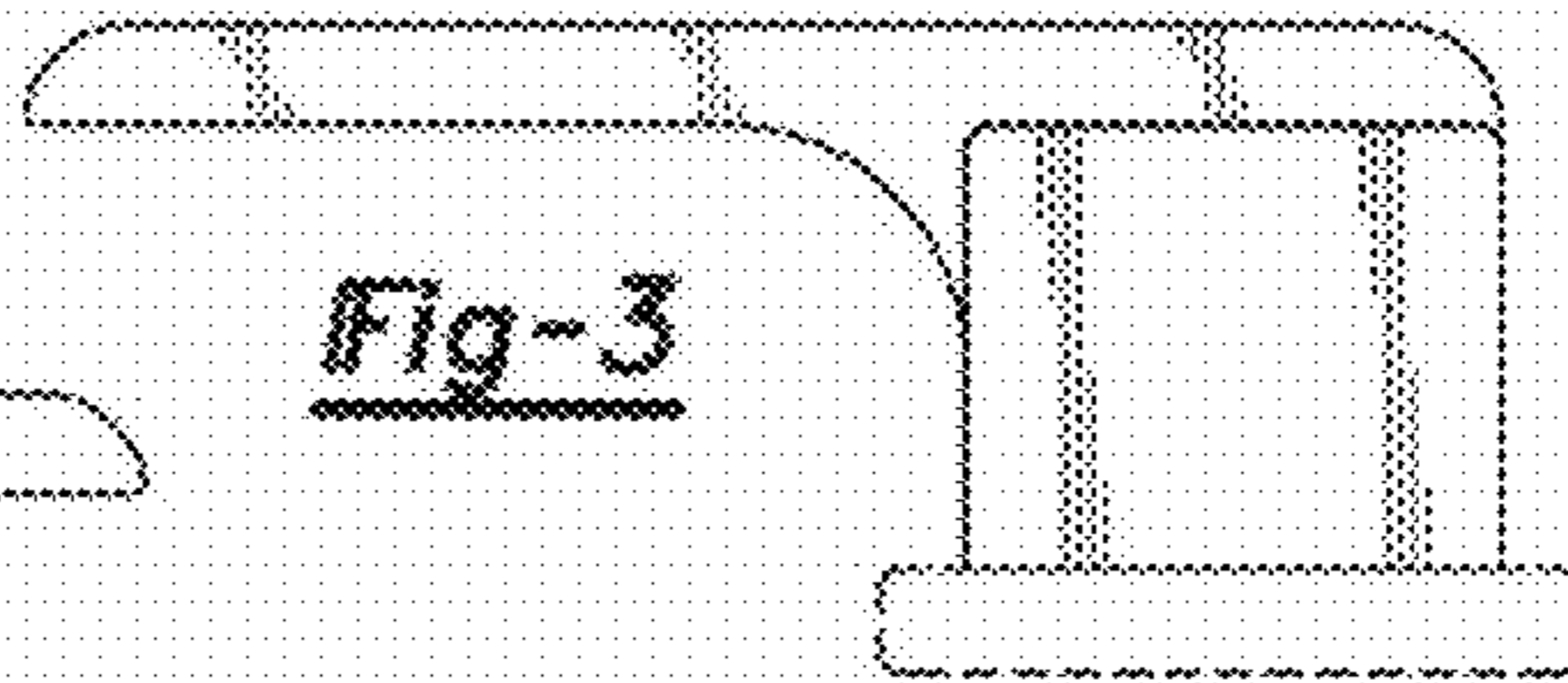

Fig-4

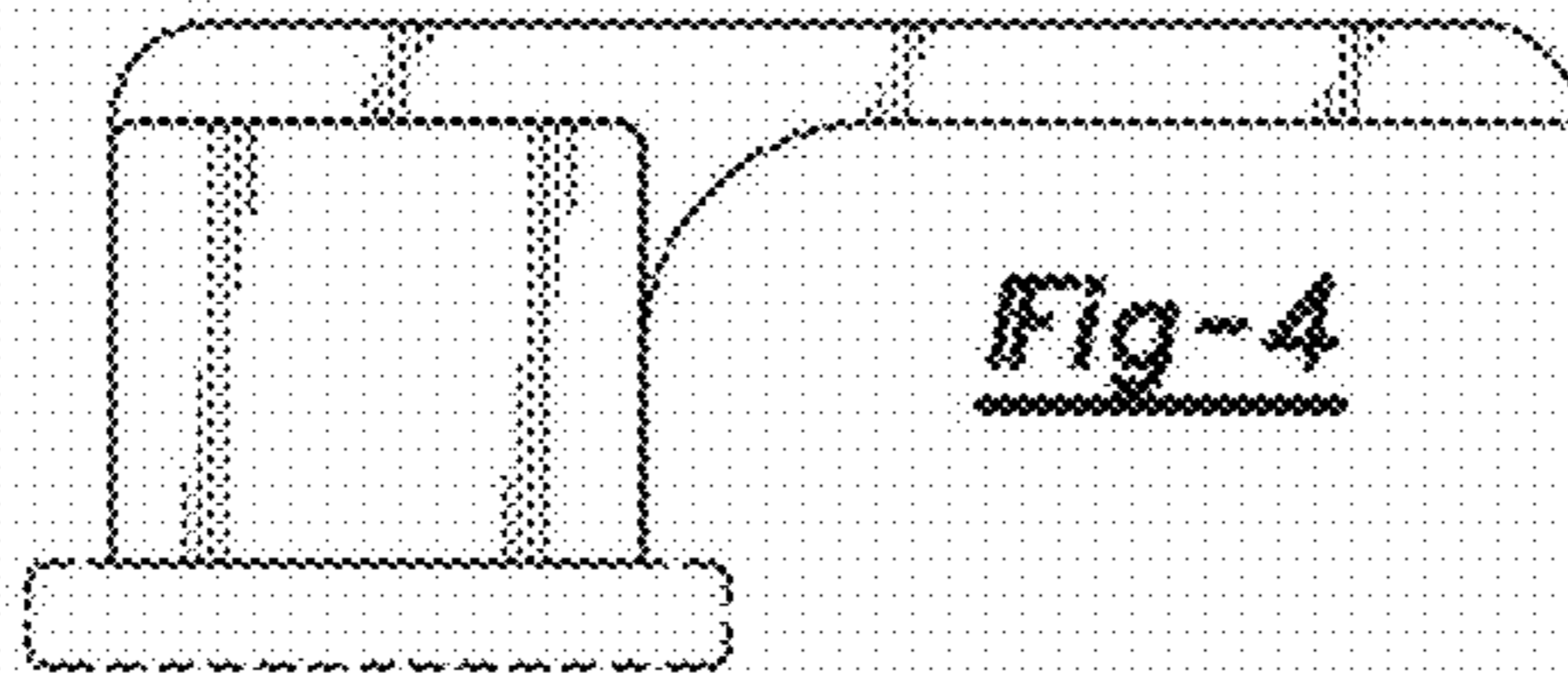

Fig-5

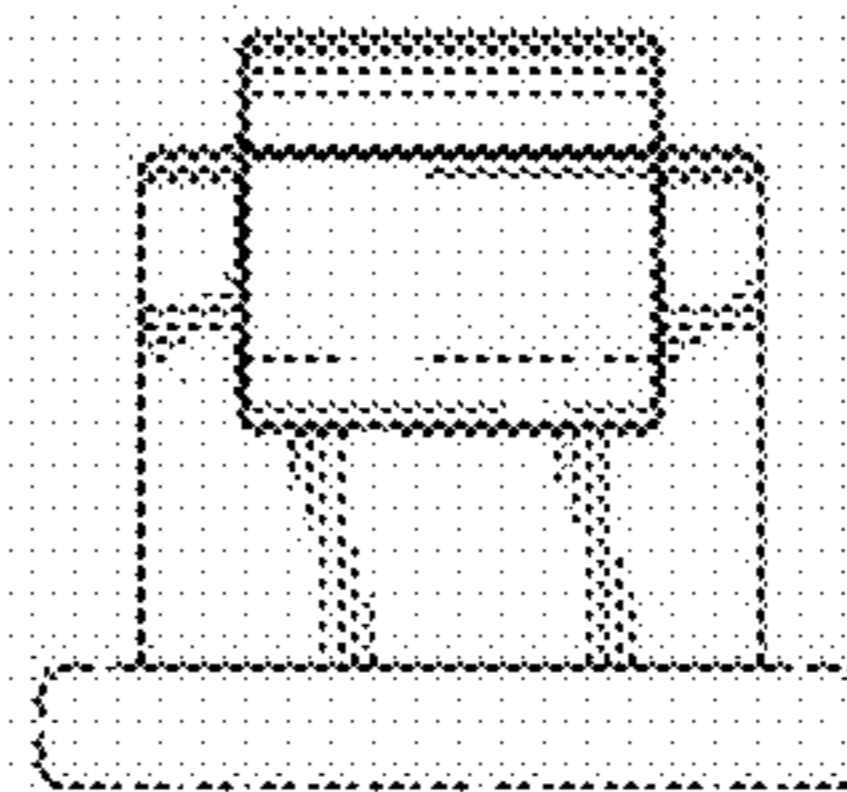

Fig-6

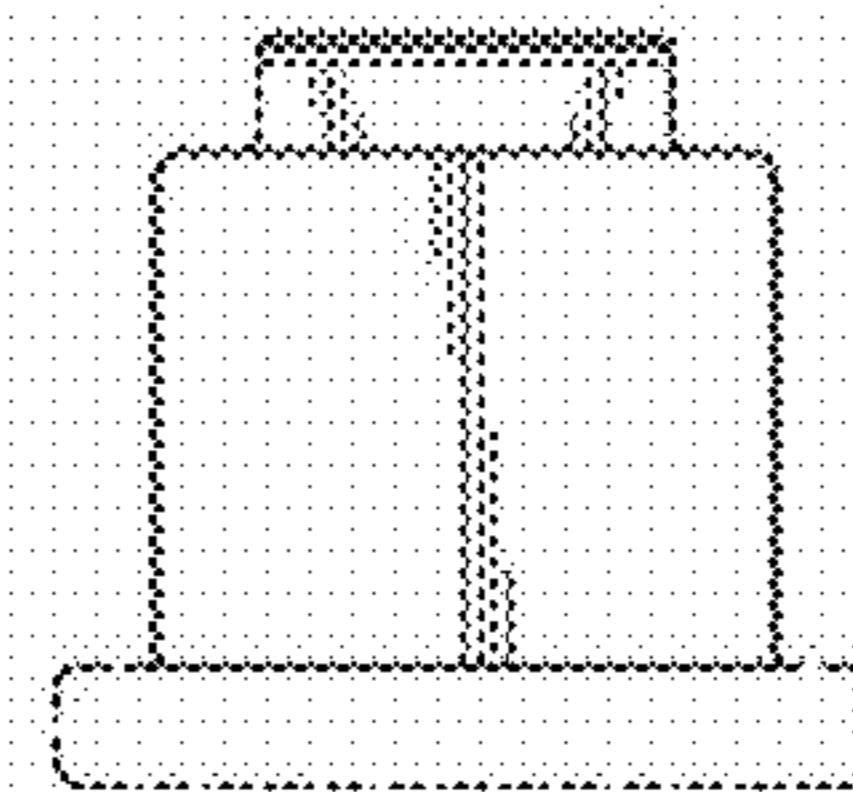

Fig-7

