



US00D675943S

(12) **United States Design Patent**  
**Chastaingt**

(10) **Patent No.:** **US D675,943 S**

(45) **Date of Patent:** **\*\* Feb. 12, 2013**

(54) **WATCH CASE**

(75) **Inventor:** **Arnaud Chastaingt, Paris (FR)**

(73) **Assignee:** **Cartier Creation Studio SA, Geneva (CH)**

(\*\*) **Term:** **14 Years**

(21) **Appl. No.:** **29/418,062**

(22) **Filed:** **Apr. 12, 2012**

(30) **Foreign Application Priority Data**

Oct. 13, 2011 (WO) ..... DM/077 626

(51) **LOC (9) Cl.** ..... **10-02**

(52) **U.S. Cl.** ..... **D10/34**

(58) **Field of Classification Search** ..... D10/30-39,  
D10/6, 7, 9, 123-126, 132; 368/276, 281,  
368/282, 283, 285, 223, 228, 229, 232; D11/31,  
D11/44, 48, 49, 52, 57, 81, 82, 84

See application file for complete search history.

(56) **References Cited**

**U.S. PATENT DOCUMENTS**

D7,772 S *	9/1874	Strasburger	.....	D10/36
D14,162 S *	8/1883	Diolot	.....	D10/124
325,433 A *	9/1885	Nivios	.....	63/28
393,248 A *	11/1888	Lewis	.....	368/285
D38,633 S *	6/1907	Arnold	.....	D11/84
D73,130 S *	7/1927	Hobe	.....	D11/224
D114,631 S *	5/1939	Bernstein	.....	D10/34
D133,477 S *	8/1942	Katz	.....	D11/41
D137,577 S *	4/1944	Bee	.....	D11/57
3,146,578 A *	9/1964	Etienne	.....	368/226
D210,993 S *	5/1968	Cohen	.....	D11/205
D296,991 S *	8/1988	Lauper	.....	D10/30

4,970,708 A *	11/1990	Gagnebin et al.	.....	368/300
D326,232 S *	5/1992	Kurebayashi	.....	D10/39
D328,866 S *	8/1992	Deleskiewicz	.....	D10/39
D347,795 S *	6/1994	Kuo	.....	D10/7
D351,361 S *	10/1994	Itoh	.....	D10/126
D351,565 S *	10/1994	Ito	.....	D10/126
D354,238 S *	1/1995	Bulgari	.....	D10/34
5,398,218 A *	3/1995	Munnier et al.	.....	368/282
D361,526 S *	8/1995	Yudovin	.....	D10/34
D368,433 S *	4/1996	Schulze	.....	D10/39
D371,745 S *	7/1996	Wunderman	.....	D10/32
D380,393 S *	7/1997	Molas	.....	D10/31
D390,128 S *	2/1998	Toribio	.....	D10/32
D418,426 S *	1/2000	Gruosi	.....	D10/7
6,891,778 B1 *	5/2005	Hohenstein et al.	.....	368/76
7,281,845 B2 *	10/2007	Hohenstein et al.	.....	368/281
D607,758 S *	1/2010	Hegi	.....	D10/39

\* cited by examiner

*Primary Examiner* — Lucy Lieberman

(74) *Attorney, Agent, or Firm* — Clifford W. Browning;  
Krieg DeVault LLP

(57) **CLAIM**

The ornamental design for a watch case, as shown and described.

**DESCRIPTION**

FIG. 1 is a top view of the watch case of the present invention. FIG. 2 is a bottom view of the watch case of FIG. 1. FIG. 3 is a back view of the watch case of FIG. 1. FIG. 4 is a front view of the watch case of FIG. 1. FIG. 5 is a right side view of the watch case of FIG. 1. FIG. 6 is a left side view of the watch case of FIG. 1; and, FIG. 7 is a top right side perspective view of the watch case of FIG. 1.

**1 Claim, 2 Drawing Sheets**

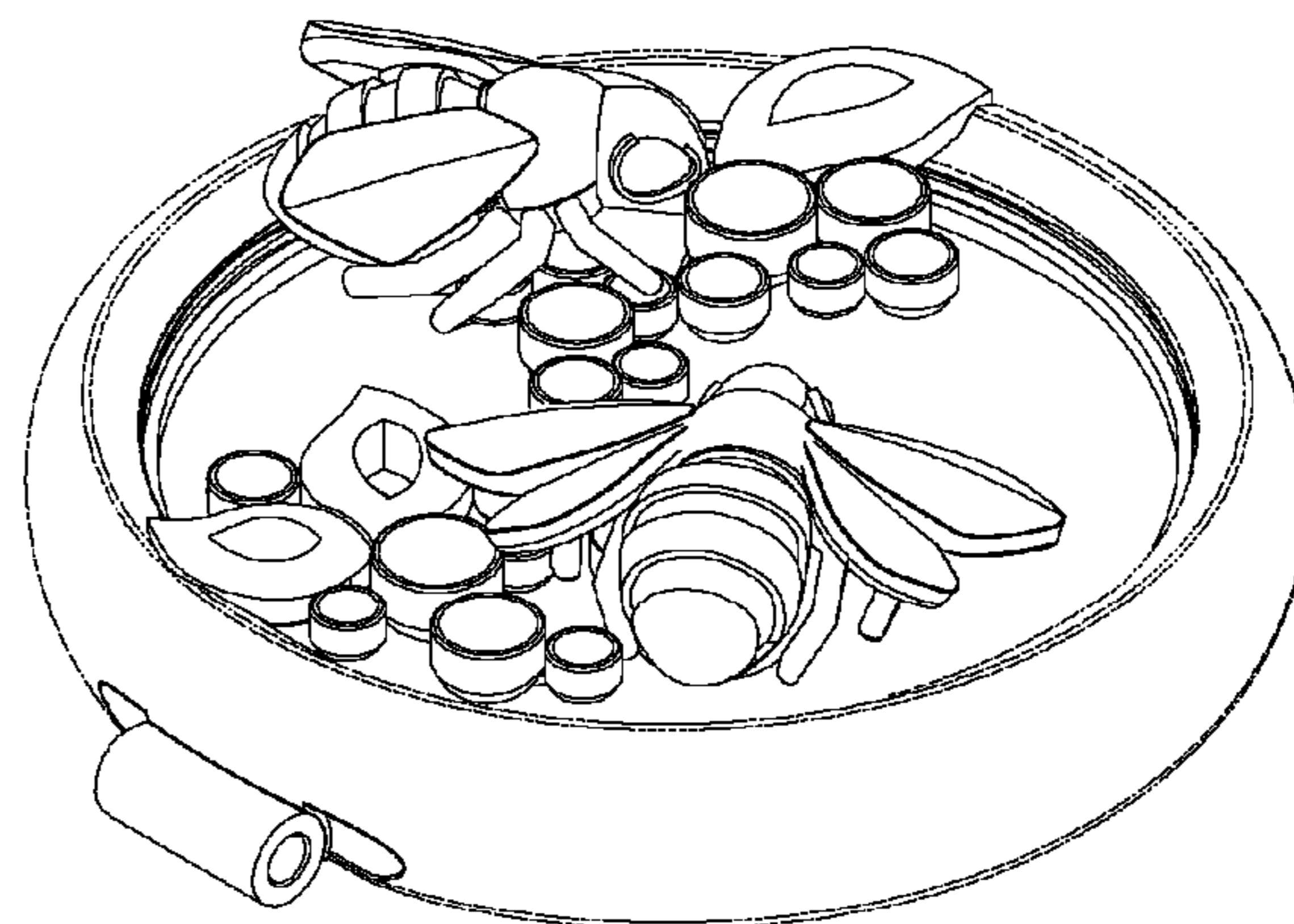



Fig. 1

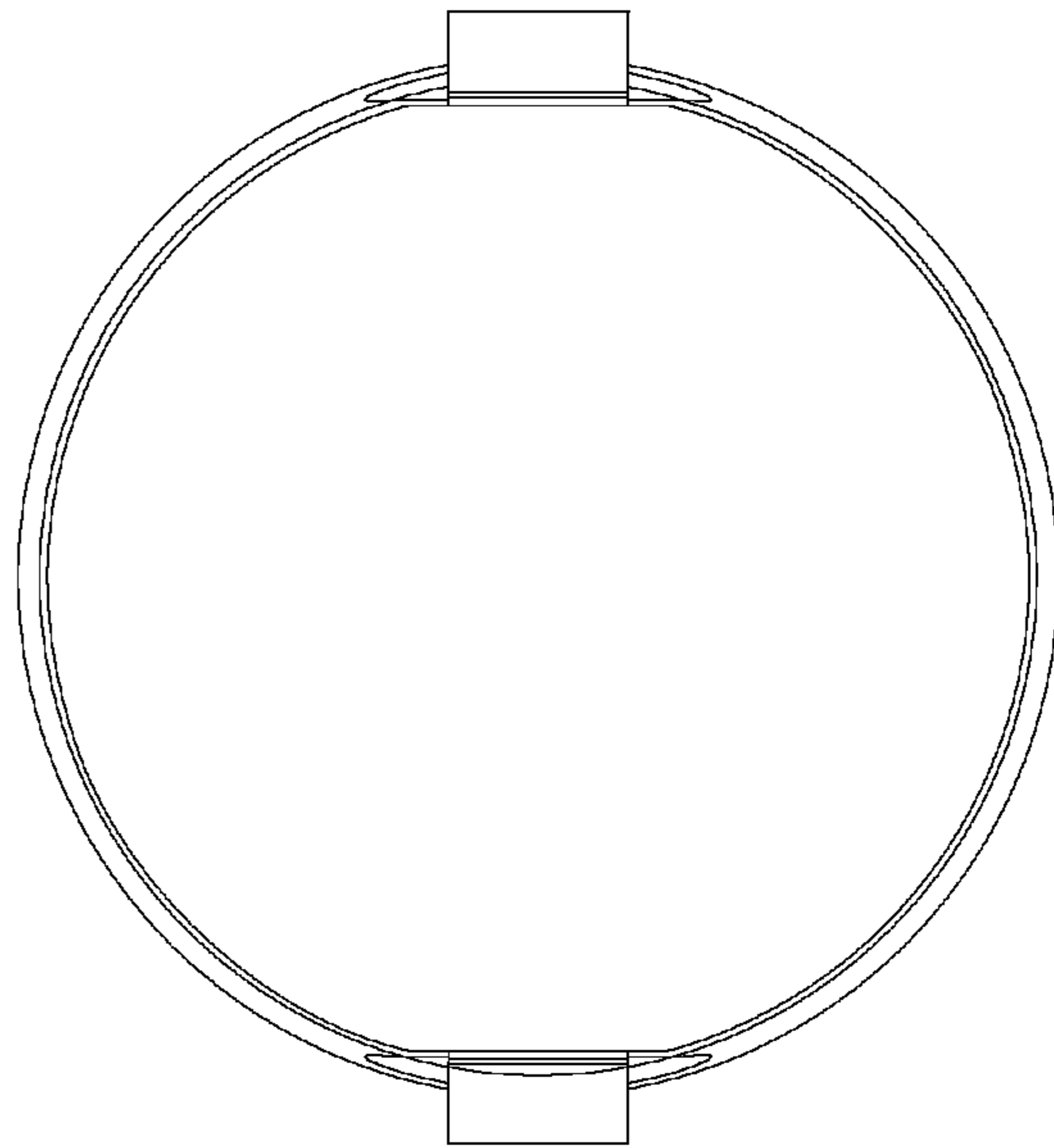

Fig. 2

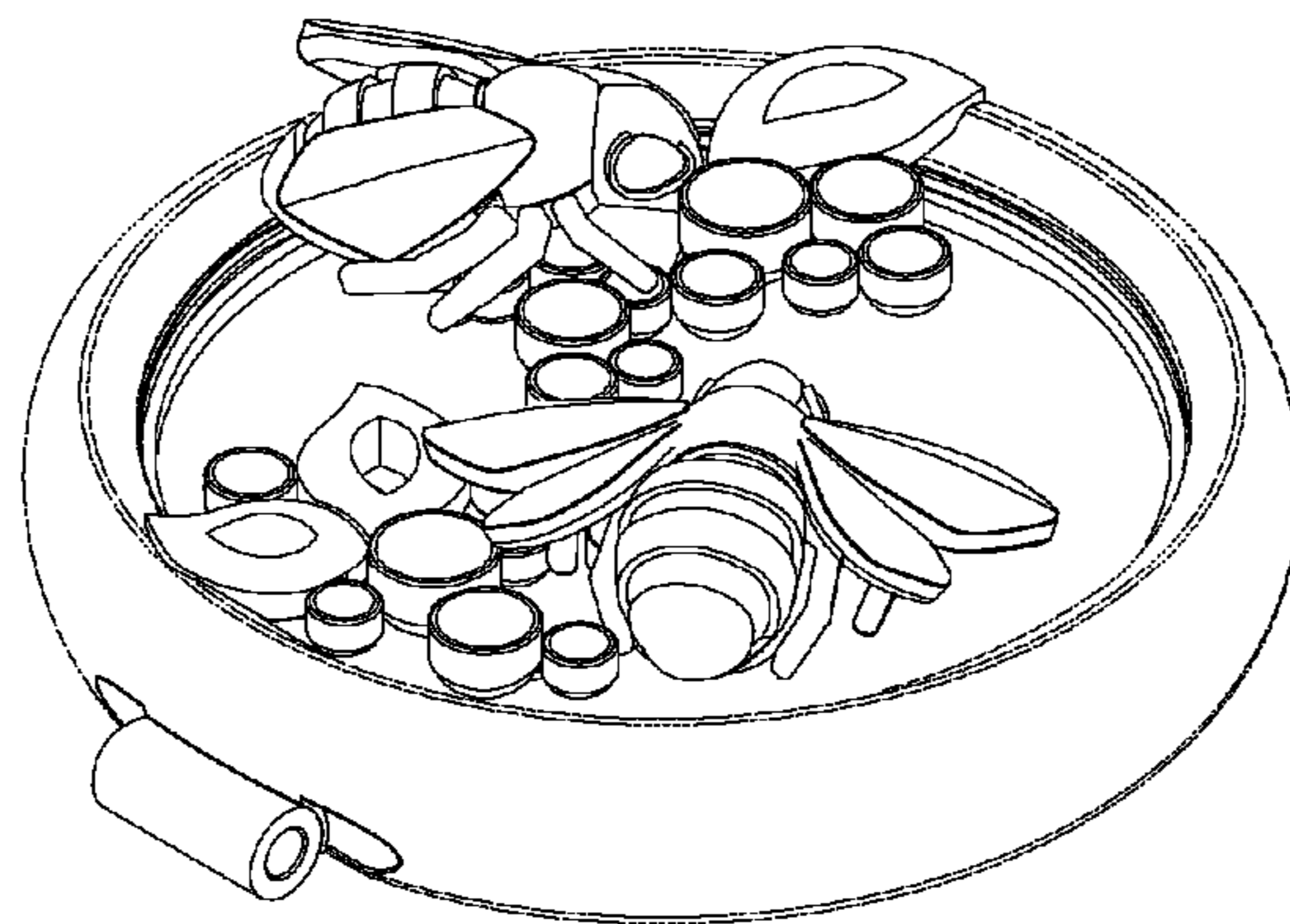

Fig. 7

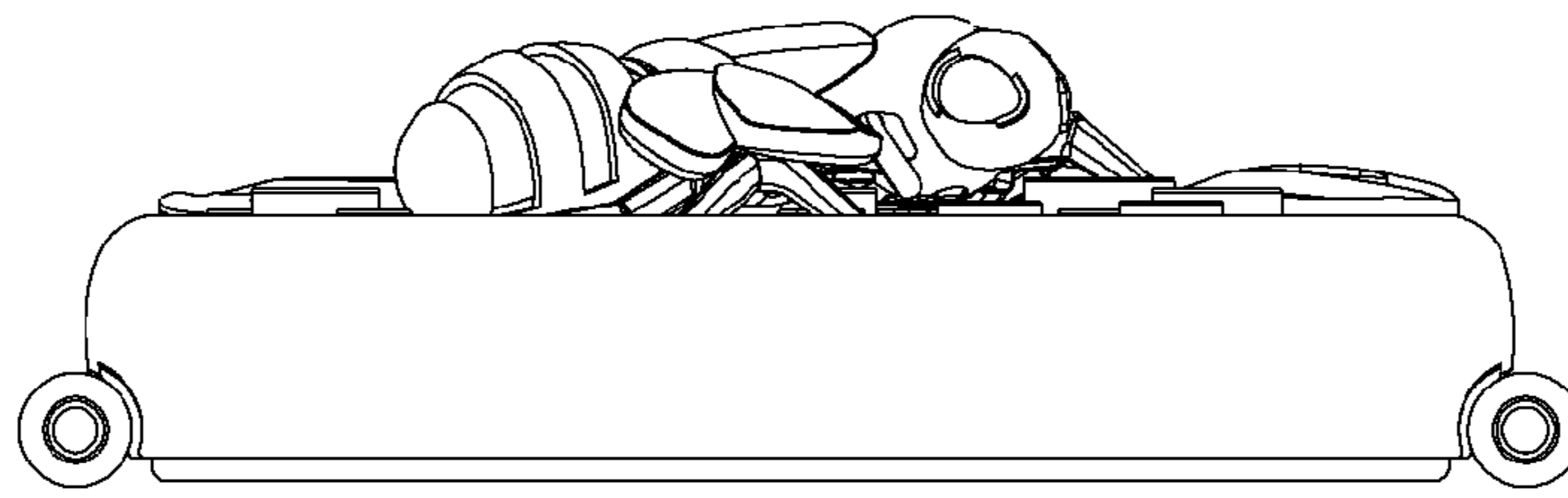

Fig. 5

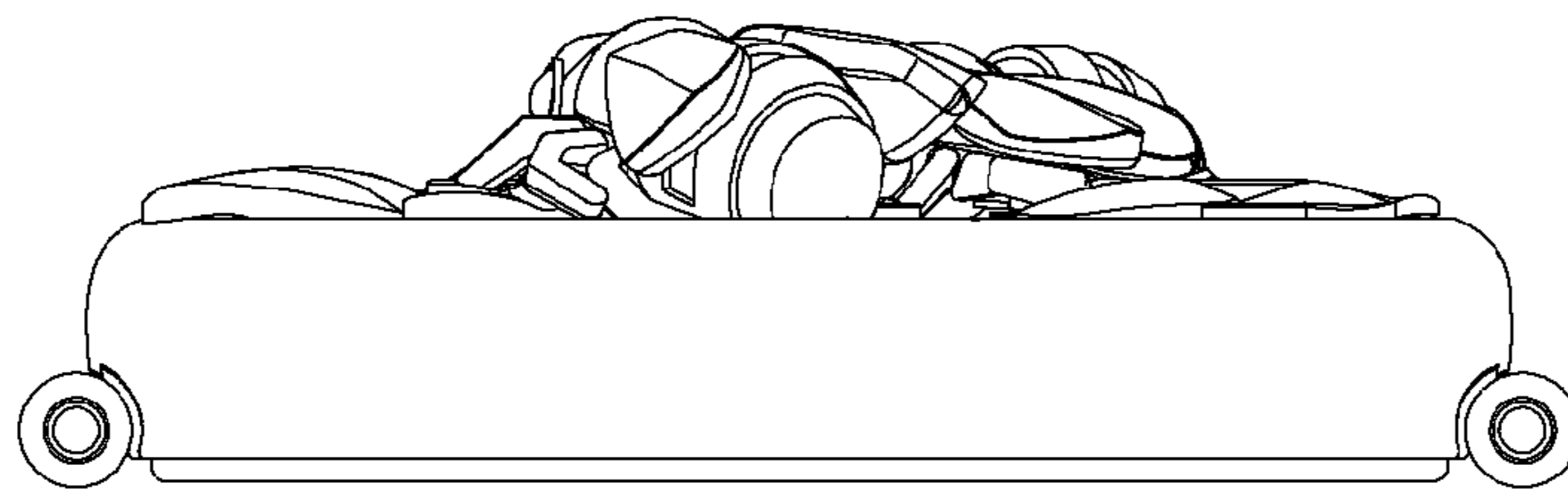

Fig. 6

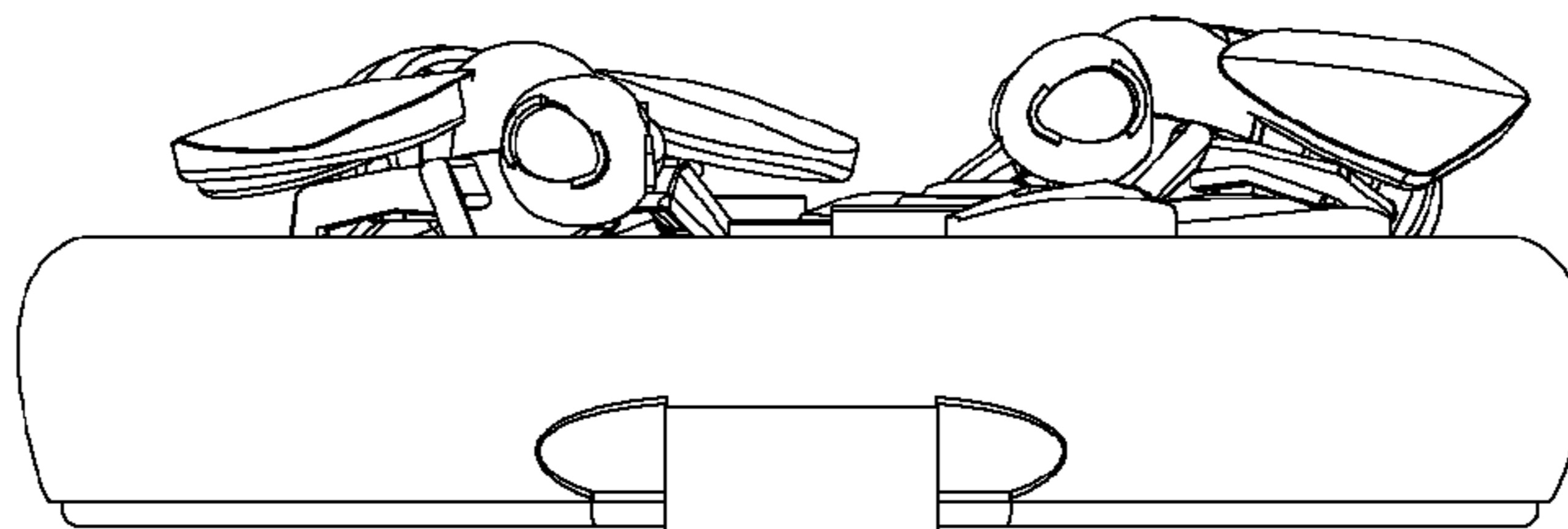

Fig. 3

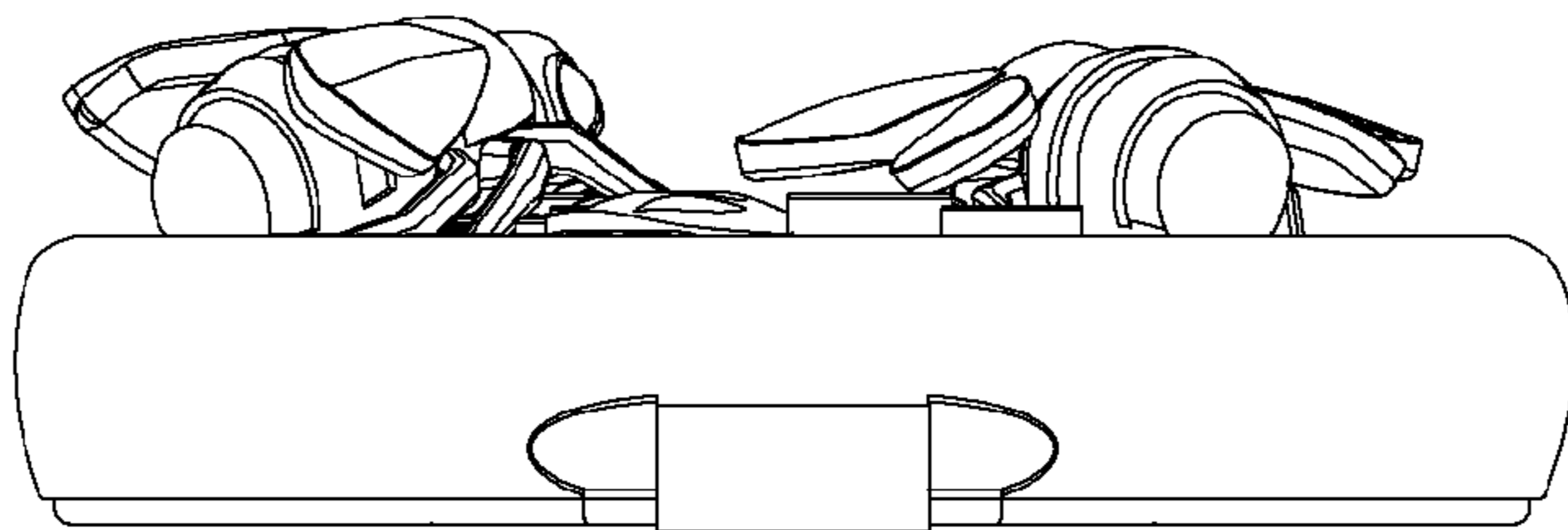

Fig. 4