



US00D675897S

(12) **United States Design Patent**
Wu

(10) **Patent No.:** **US D675,897 S**

(45) **Date of Patent:** **** Feb. 12, 2013**

(54) **DUAL HEAD UTILITY KNIFE**

(76) Inventor: **Yuewei Wu, Ninghai (CN)**

(**) Term: **14 Years**

(21) Appl. No.: **29/362,217**

(22) Filed: **May 21, 2010**

(51) **LOC (9) Cl.** **08-03**

(52) **U.S. Cl.** **D8/99**

(58) **Field of Classification Search** D8/95-99,
D8/105, 107; D22/118; 30/154-162, 329-331,
30/339

See application file for complete search history.

(56) **References Cited**

U.S. PATENT DOCUMENTS

D323,967 S *	2/1992	Talbot	D8/98
D336,028 S *	6/1993	Yoshimoto	D8/99
D371,949 S *	7/1996	Abucewicz et al.	D8/107
D458,106 S *	6/2002	Chong	D8/99
D459,189 S *	6/2002	Chong	D8/99
D460,908 S *	7/2002	Sun	D8/99
D476,214 S *	6/2003	Hsu	D8/99
D559,072 S *	1/2008	Fraga	D8/99

D565,381 S *	4/2008	Wu	D8/99
D573,436 S *	7/2008	Wu	D8/99
D582,746 S *	12/2008	Neiser	D8/98
2009/0235533 A1 *	9/2009	Huang	30/143

* cited by examiner

Primary Examiner — Philip S Hyder

Assistant Examiner — Roselynn Cody

(57) **CLAIM**

The ornamental design for the dual head utility knife, as shown and described.

DESCRIPTION

FIG. 1 is a front view of a dual head utility knife showing my new design;

FIG. 2 is a top view thereof;

FIG. 3 is a bottom view thereof;

FIG. 4 is a right side view thereof;

FIG. 5 is a left side view thereof;

FIG. 6 is a rear view thereof;

FIG. 7 is a perspective view thereof; and,

FIG. 8 is another perspective view thereof.

1 Claim, 4 Drawing Sheets

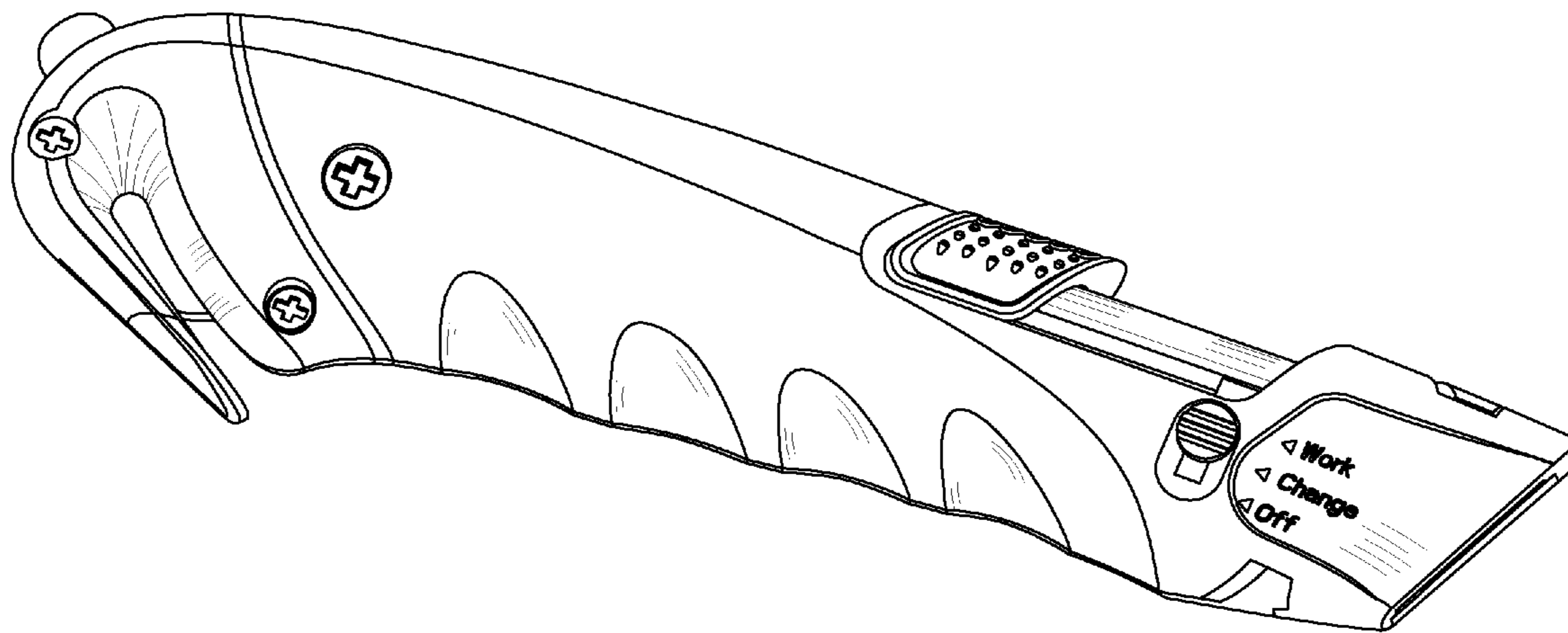

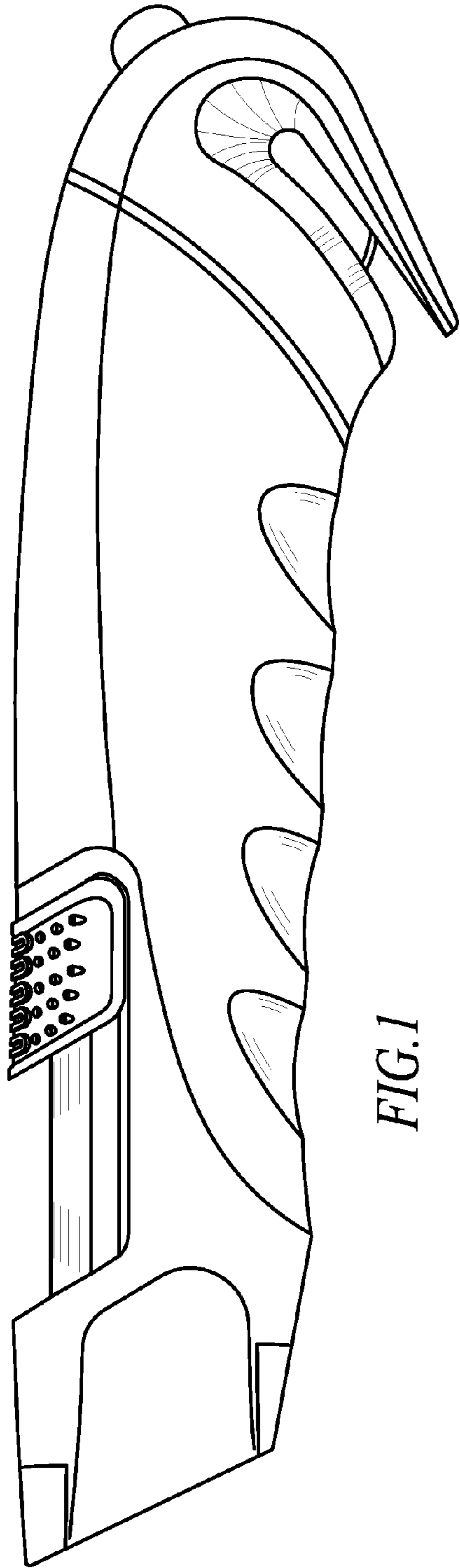

FIG. 1



FIG. 2

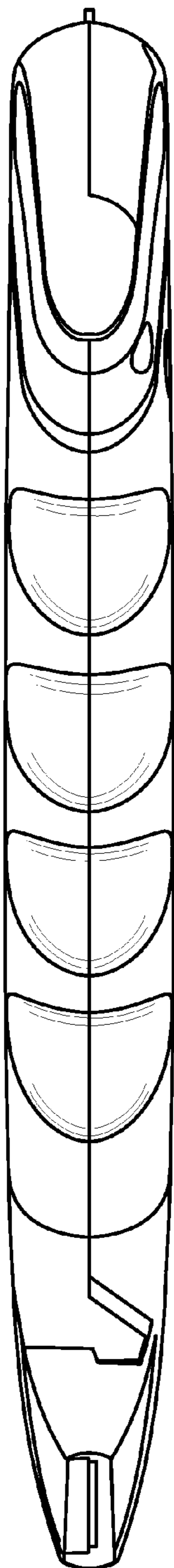

FIG. 3

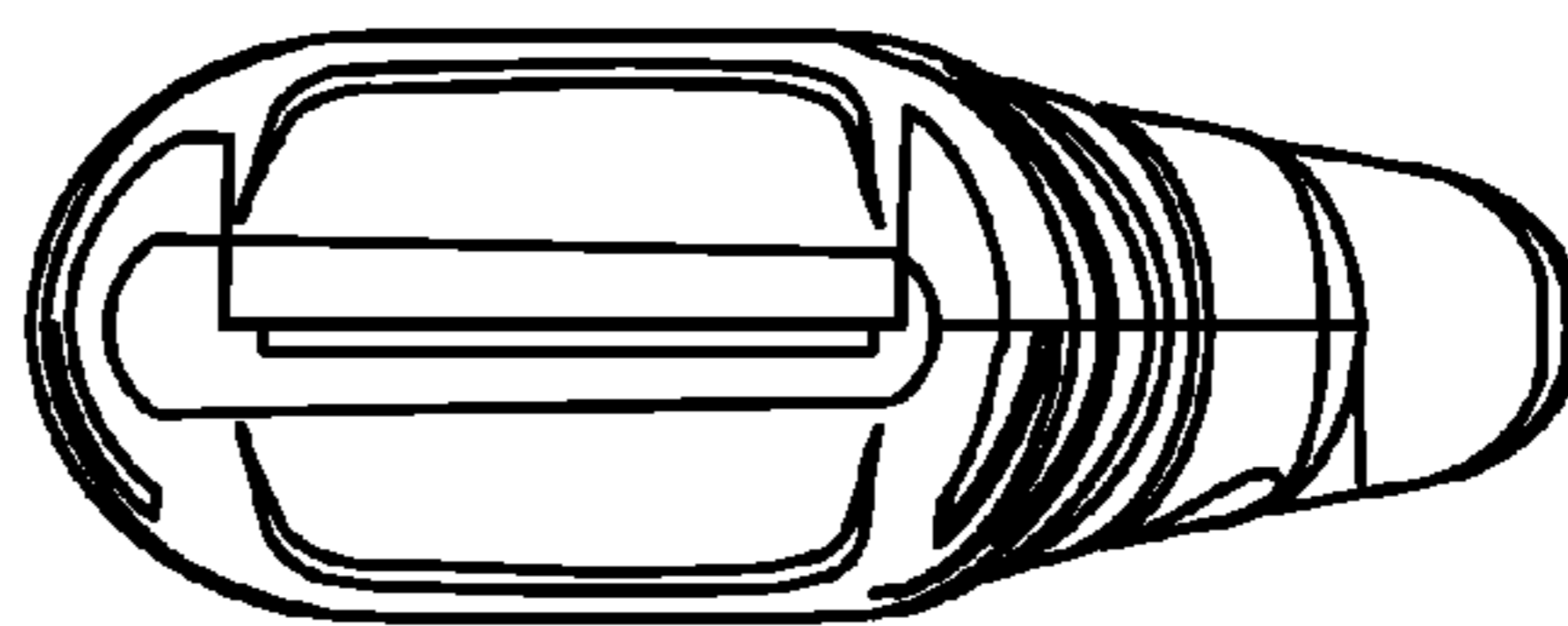

FIG. 5

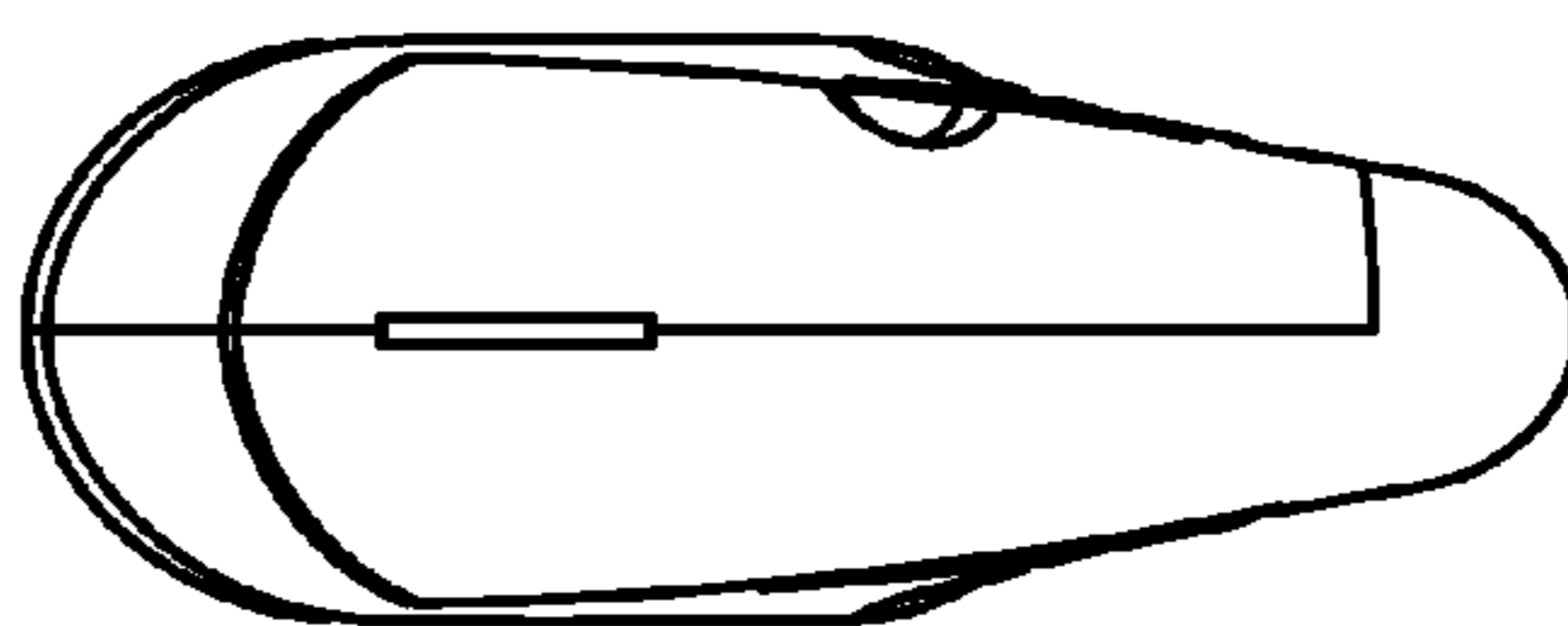

FIG. 4

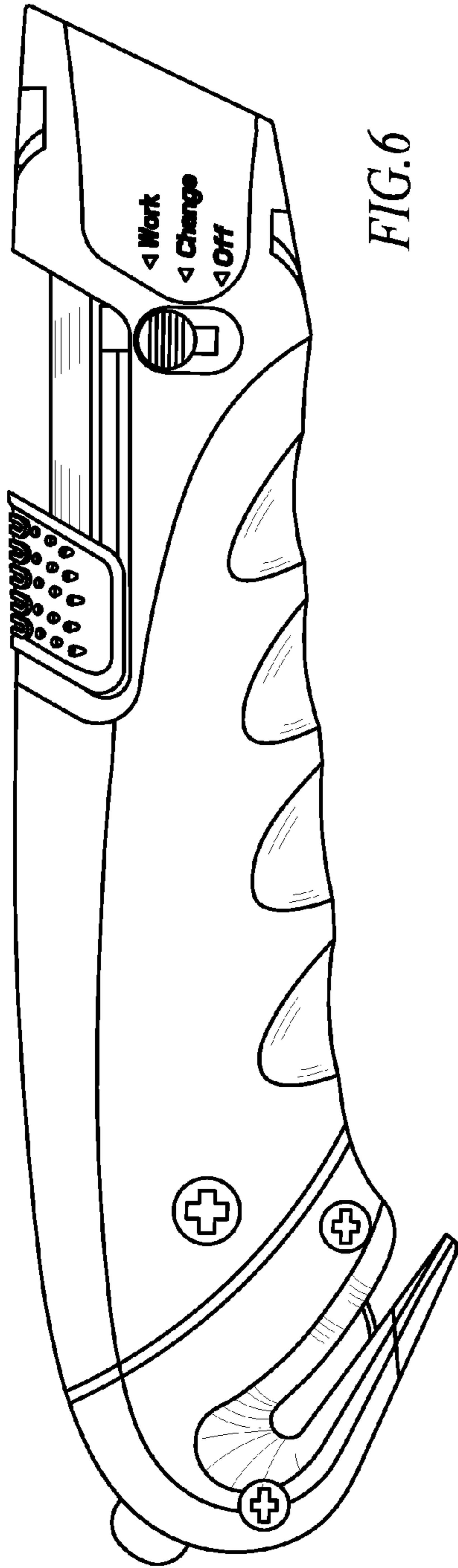

FIG. 6

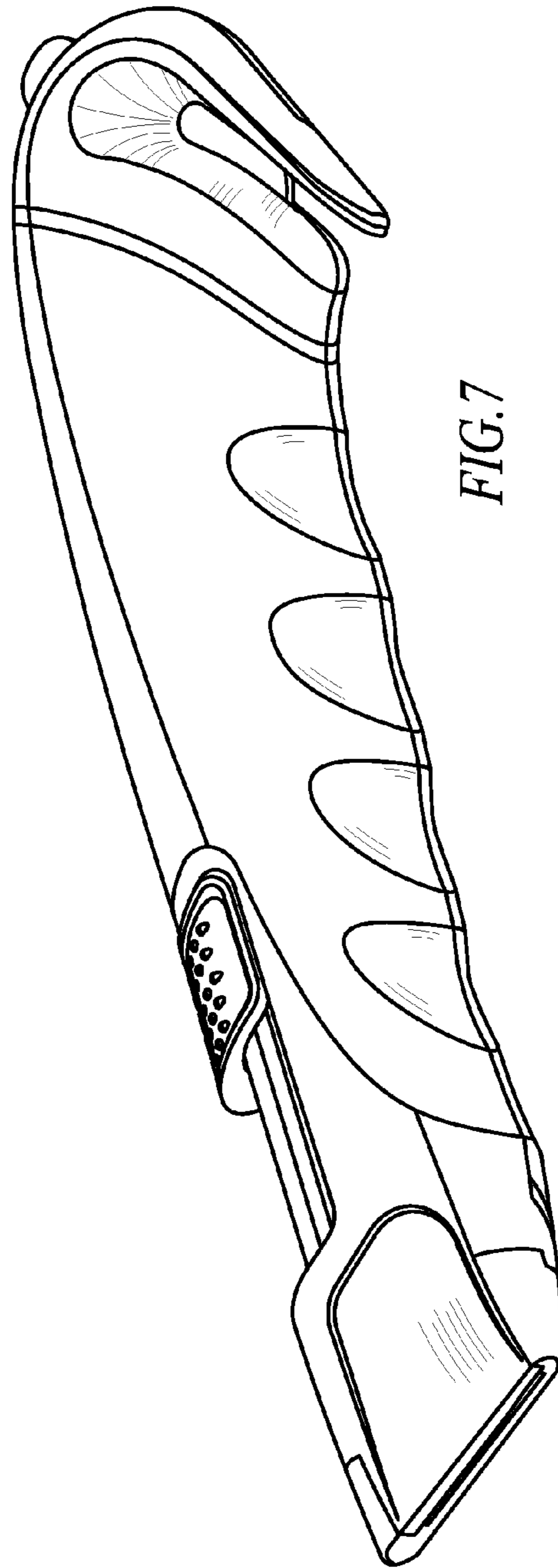

FIG. 7

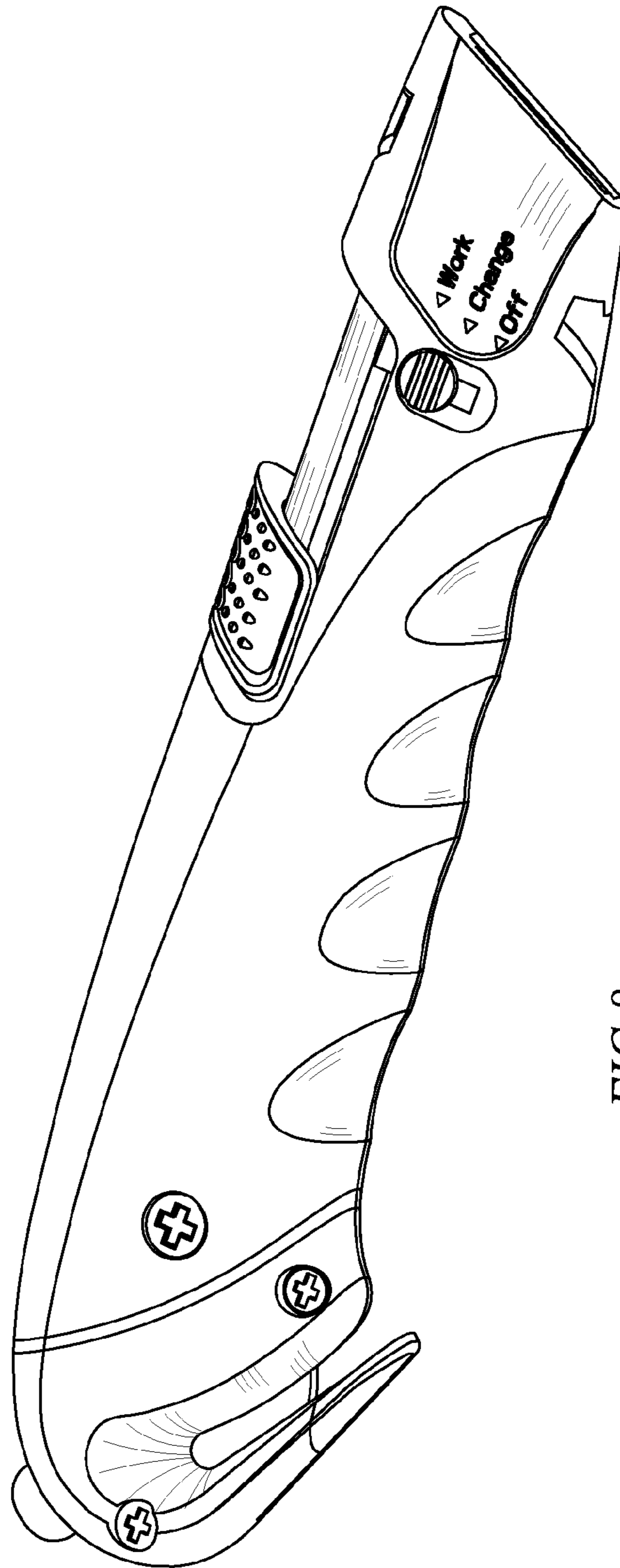

FIG.8