



US00D675826S

(12) **United States Design Patent**
Yun

(10) **Patent No.:** **US D675,826 S**

(45) **Date of Patent:** **** Feb. 12, 2013**

(54) **AUXILIARY POUCH**

(76) Inventor: **Yong-Hwa Yun**, Seoul (KR)

(**) Term: **14 Years**

(21) Appl. No.: **29/378,503**

(22) Filed: **Nov. 5, 2010**

(30) **Foreign Application Priority Data**

Sep. 16, 2010 (KR) 30-2010-0040881

(51) **LOC (9) Cl.** **03-01**

(52) **U.S. Cl.** **D3/318**

(58) **Field of Classification Search** D3/232,
D3/301, 216, 318; 150/100, 103-110, 113-114,
150/117-119; 224/153

See application file for complete search history.

(56) **References Cited**

U.S. PATENT DOCUMENTS

2,475,277 A * 7/1949 Budnik 150/118
D431,353 S * 10/2000 Mellin D3/203.1
D469,609 S * 2/2003 Hoffman D3/301
6,742,684 B2 * 6/2004 Oh 224/153
D516,306 S * 3/2006 Koenig et al. D3/233

D621,610 S * 8/2010 Parsley et al. D3/232
D625,915 S * 10/2010 Parsley et al. D3/232
D660,587 S * 5/2012 Descotis D3/237

* cited by examiner

Primary Examiner — Holly Baynham

(74) *Attorney, Agent, or Firm* — Flaster/Greenberg PC

(57) **CLAIM**

The ornamental design for an auxiliary pouch, as shown and described.

DESCRIPTION

FIG. 1 is a perspective view of a an auxiliary pouch;

FIG. 2 is a front view of the auxiliary pouch;

FIG. 3 is a rear view of the auxiliary pouch;

FIG. 4 is a left side view of the auxiliary pouch;

FIG. 5 is a right side view of the auxiliary pouch;

FIG. 6 is a plan view of the auxiliary pouch;

FIG. 7 is a bottom view of the auxiliary pouch; and,

FIG. 8 is a reduced scale, environmental view of the auxiliary pouch.

The objects represented by broken lines in FIG. 8 form no part of the claimed design and are included for the purpose of illustrating the environment in which the auxiliary pouch may be used.

1 Claim, 6 Drawing Sheets

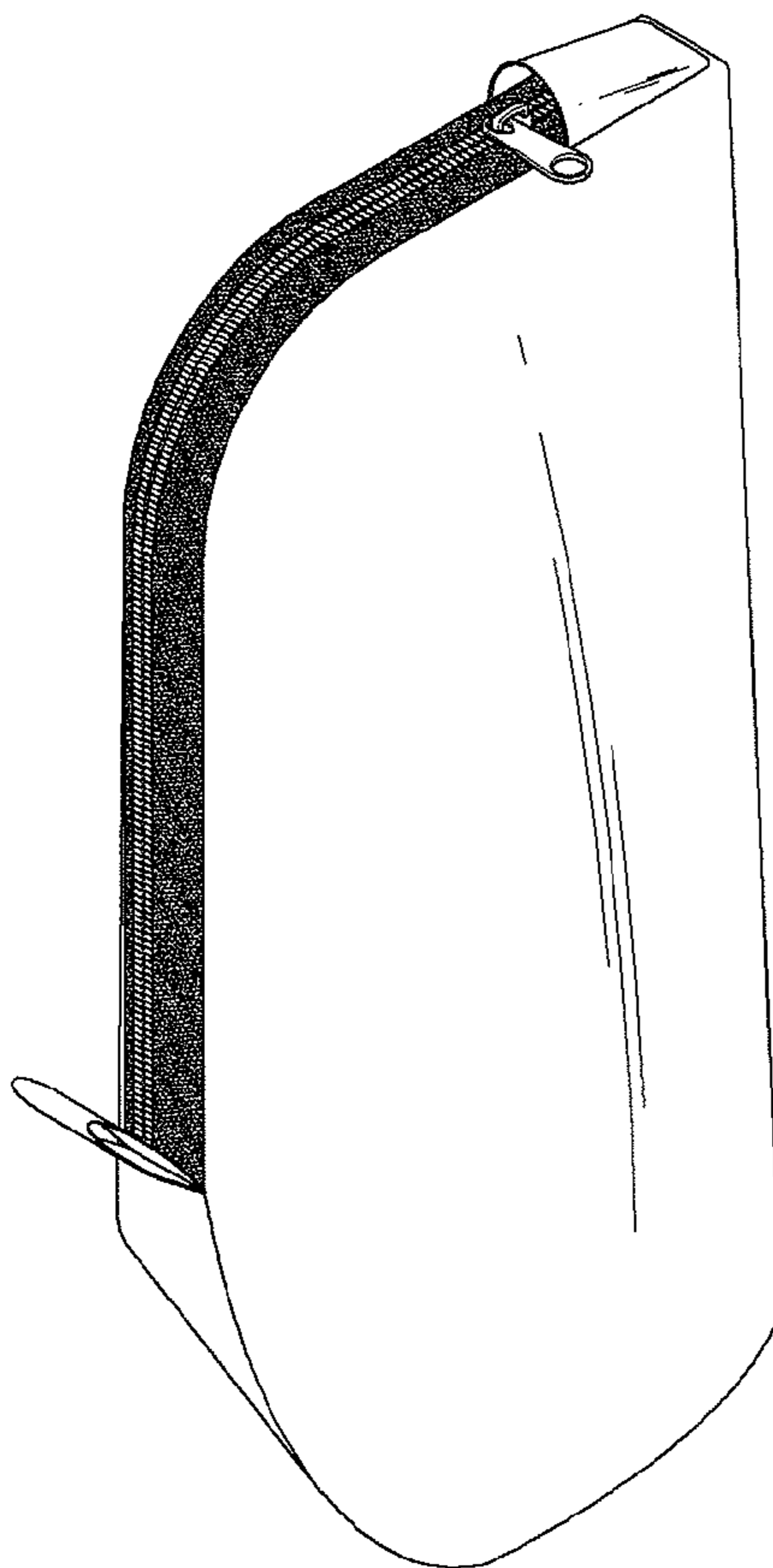

Fig. 1

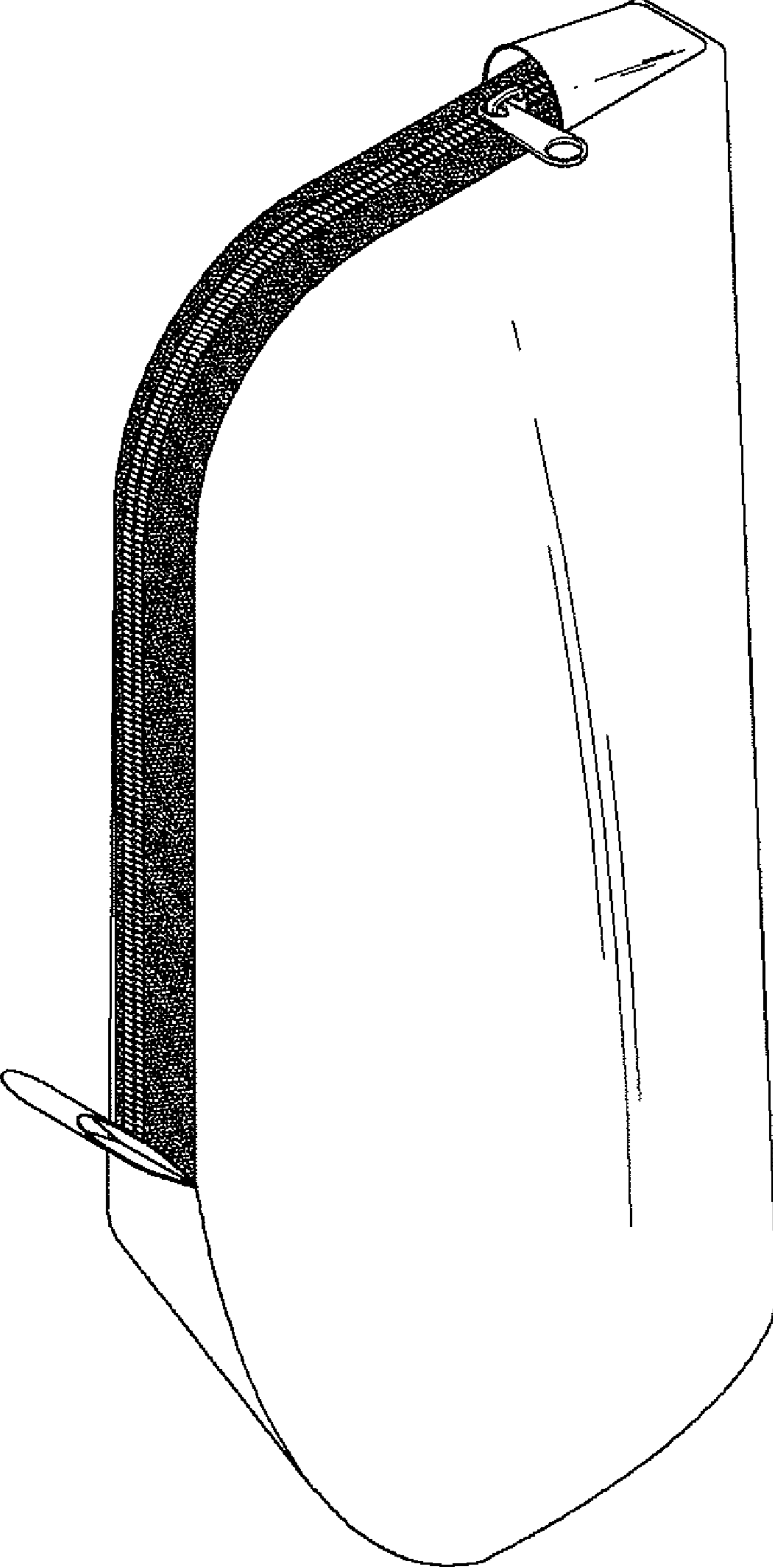

Fig. 2

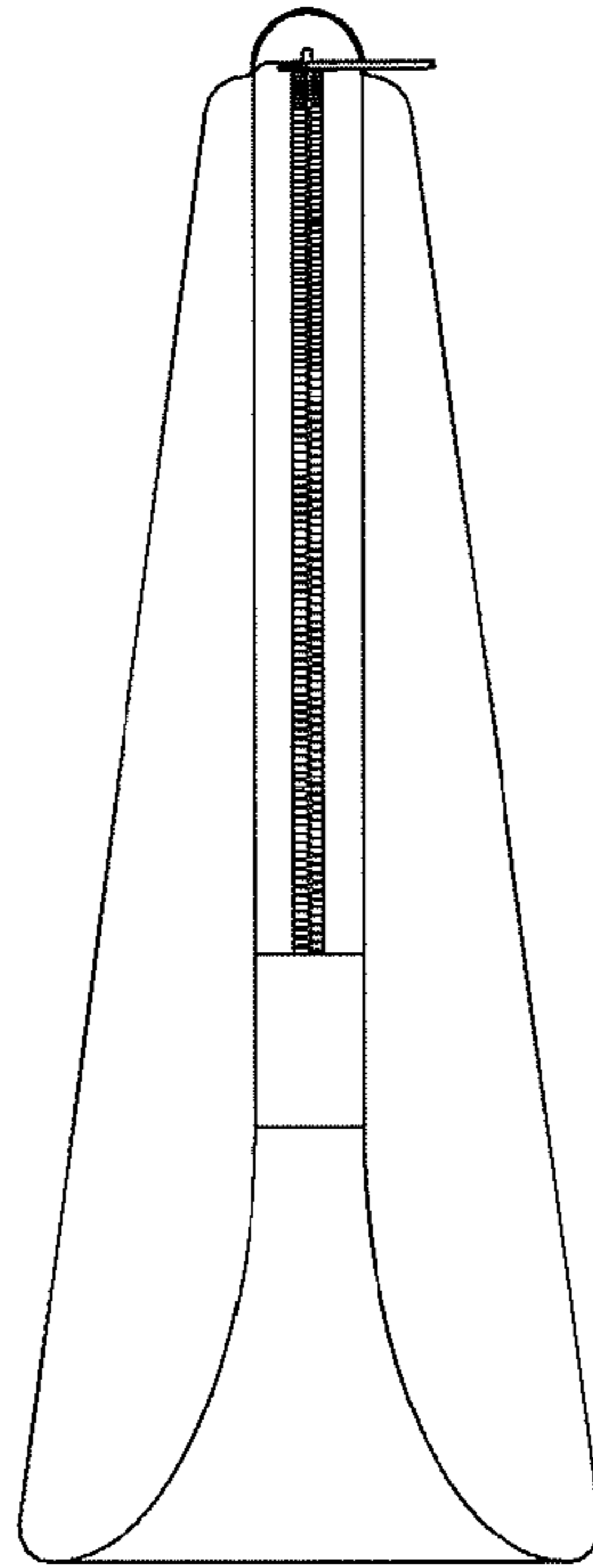

Fig. 3

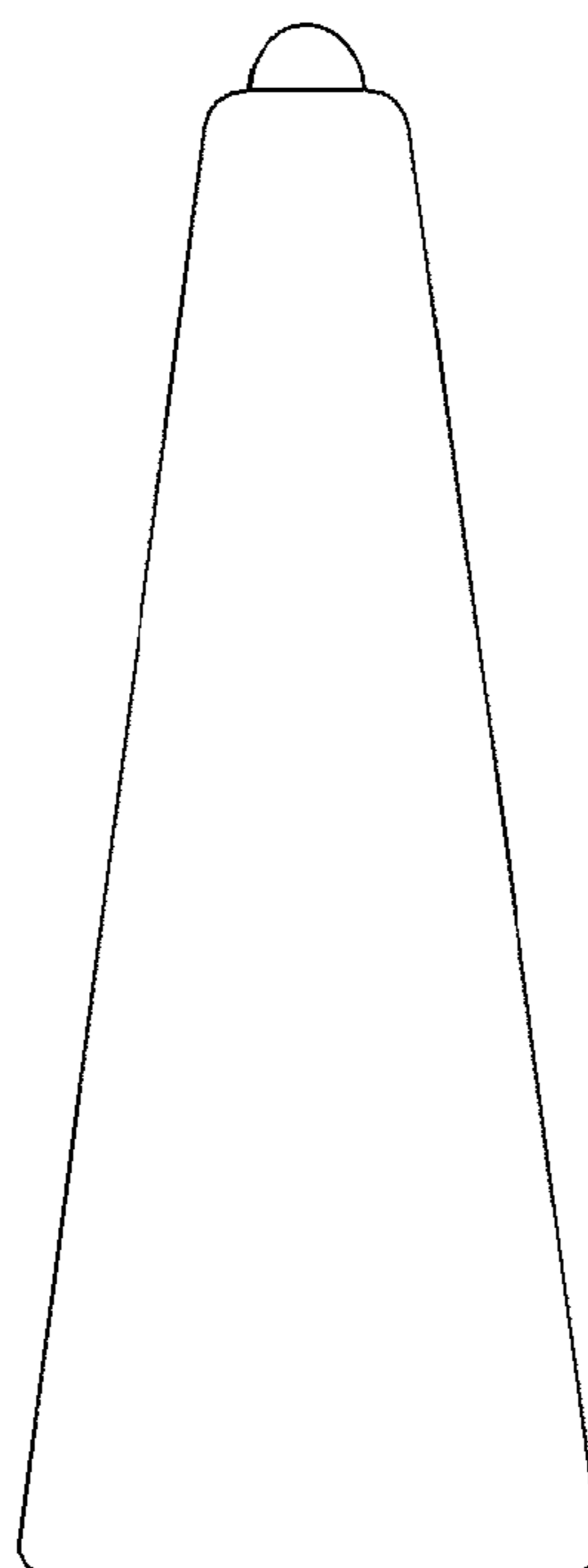

Fig. 4

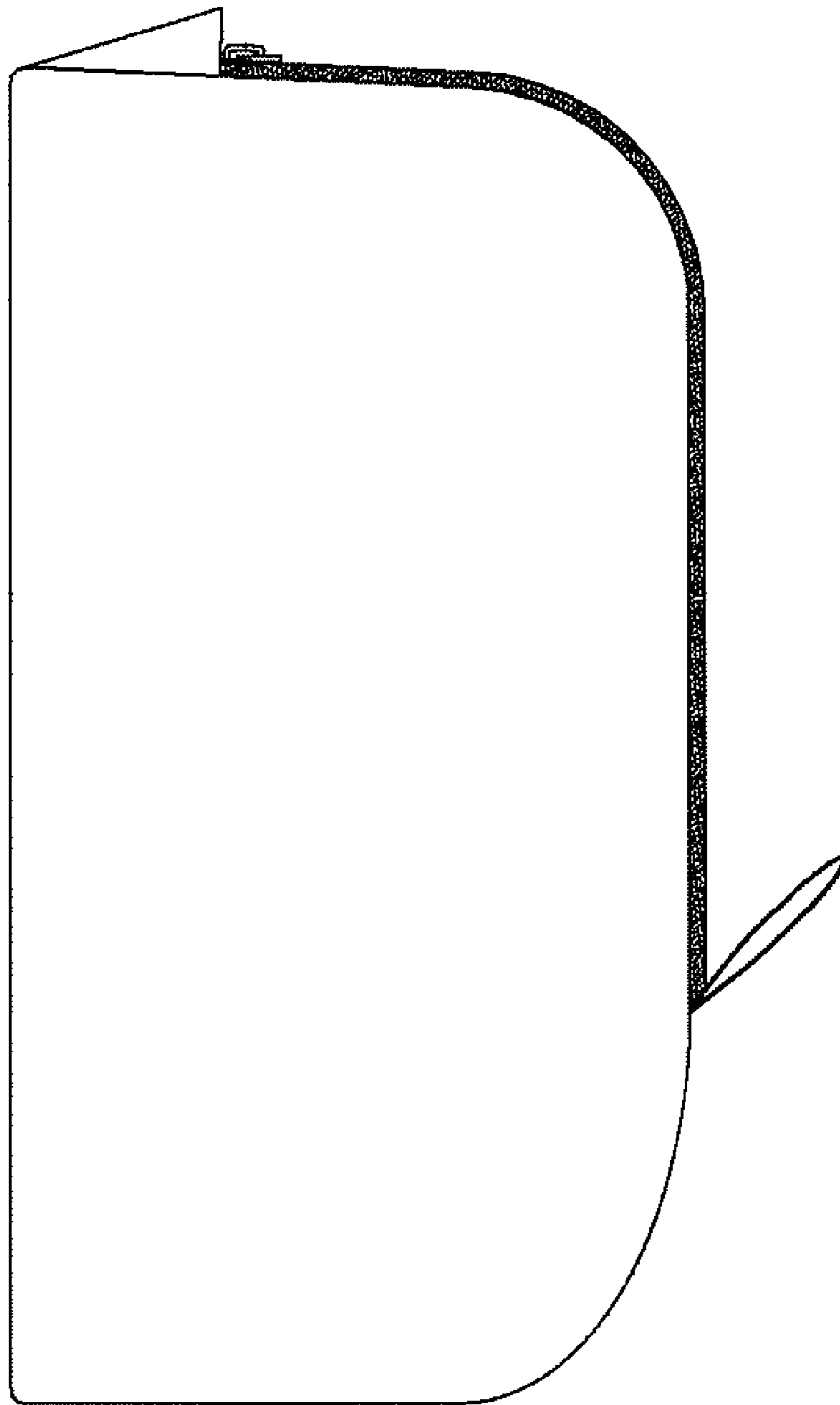

Fig. 5

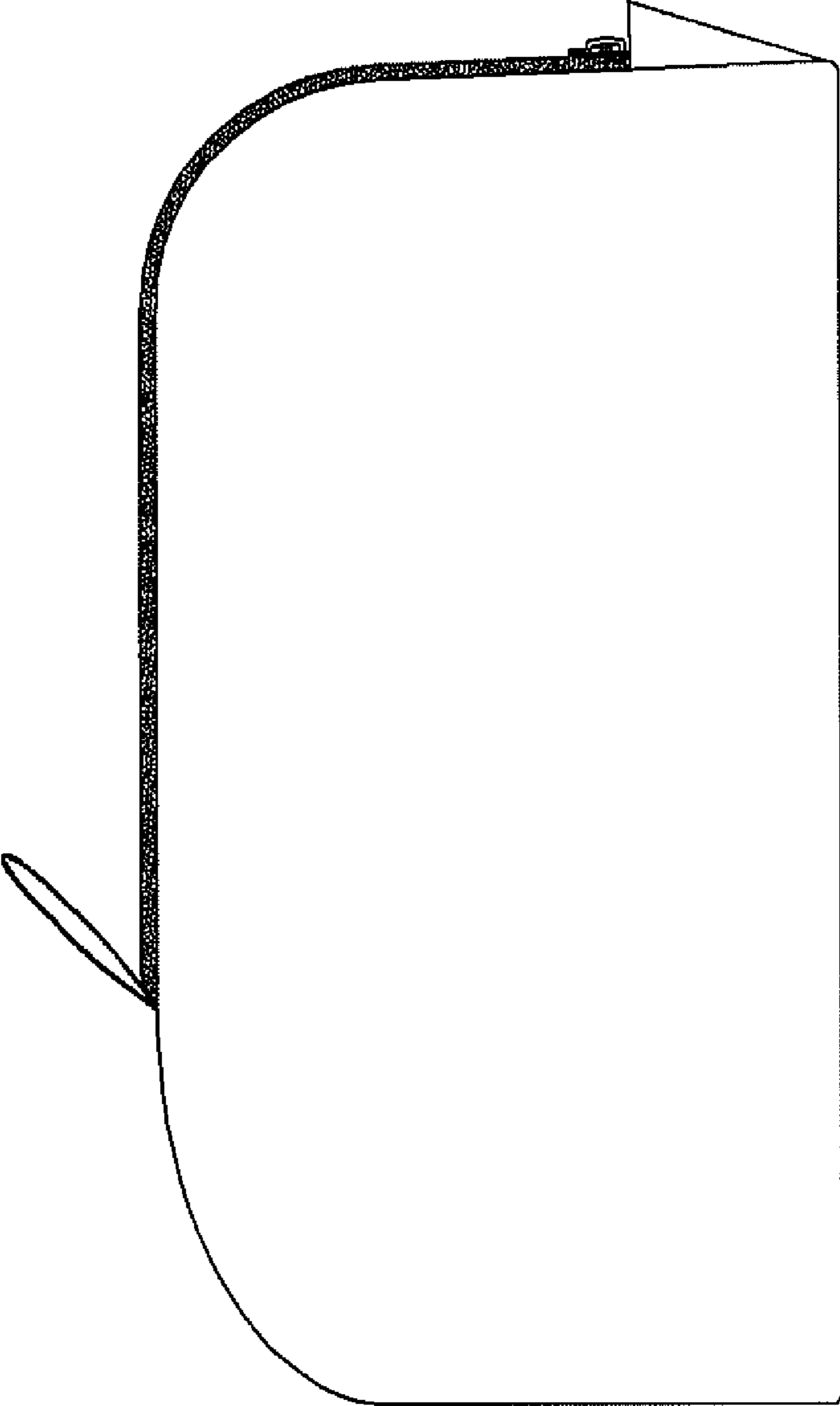

Fig. 6

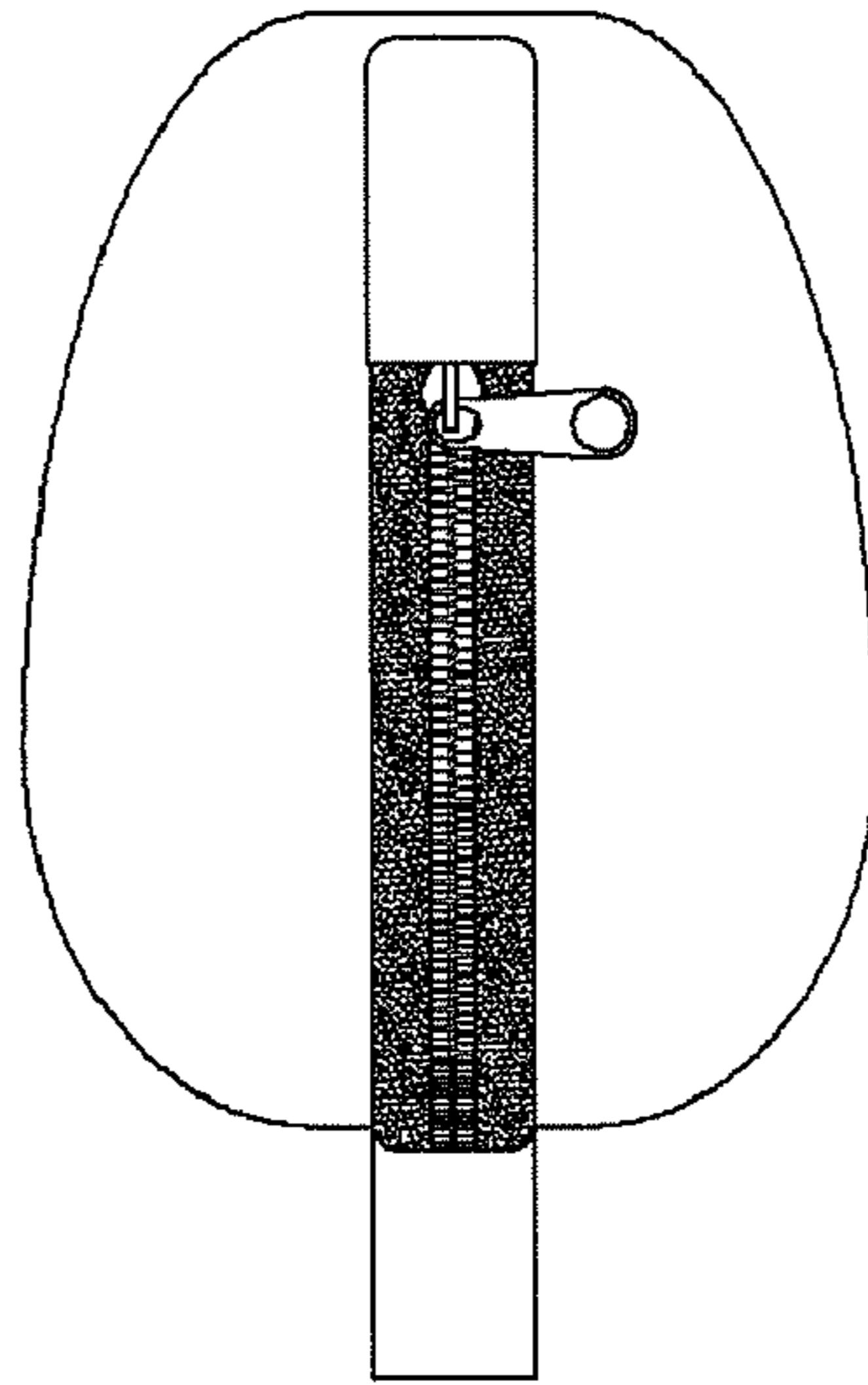

Fig. 7

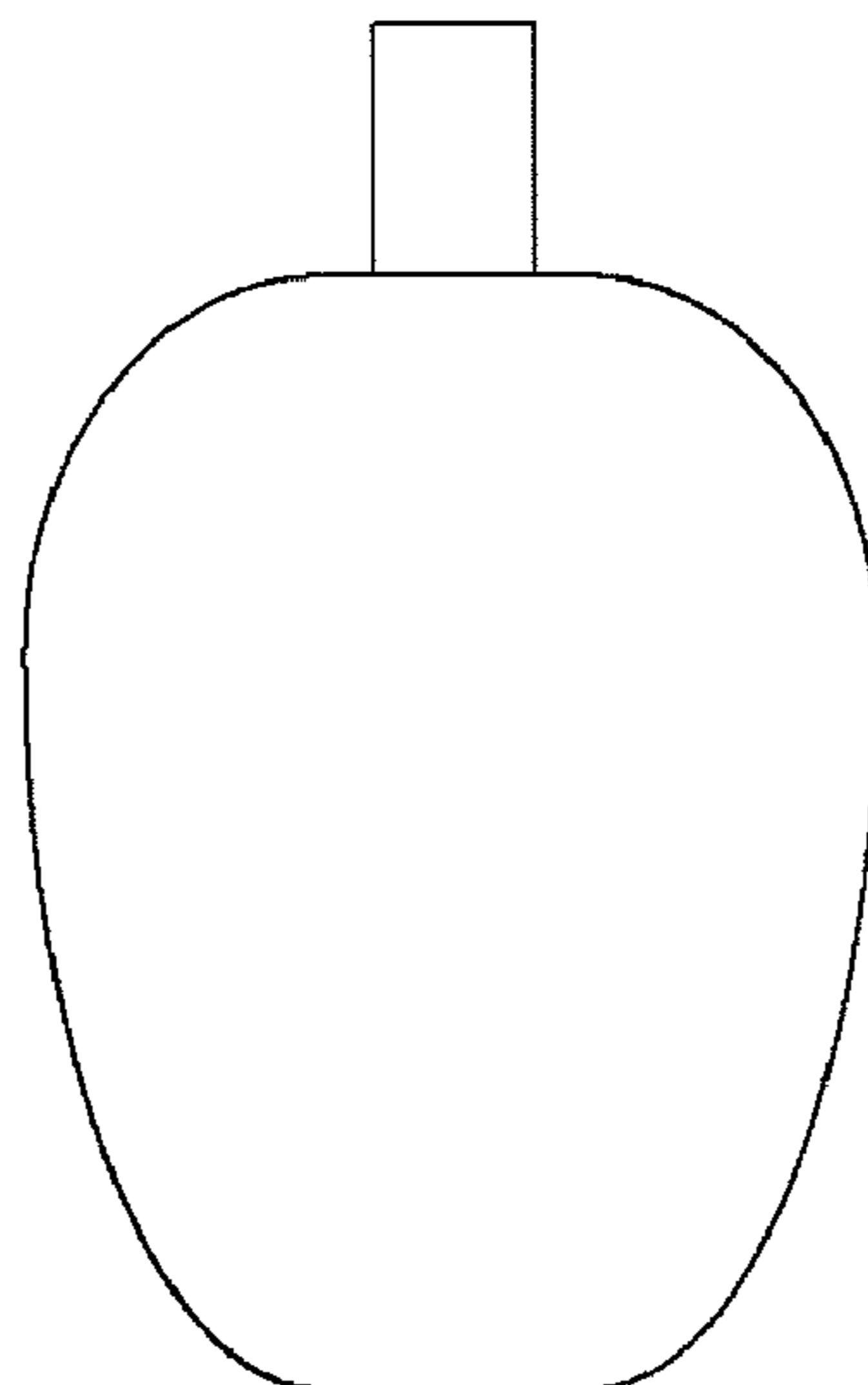

Fig. 8



the present design