



US00D675796S

(12) **United States Design Patent**
Benacquisto et al.

(10) **Patent No.:** **US D675,796 S**
(45) **Date of Patent:** **** Feb. 5, 2013**

(54) **DEEP CLEANER**

(75) Inventors: **Justin Benacquisto**, Caledonia, MI (US); **Dave Miller**, Zeeland, MI (US); **Jonathan Stanley**, East Grand Rapids, MI (US)

(73) Assignee: **BISSELL Homecare, Inc.**, Grand Rapids, MI (US)

(**) Term: **14 Years**

(21) Appl. No.: **29/415,299**

(22) Filed: **Mar. 9, 2012**

(51) **LOC (9) Cl.** **15-05**

(52) **U.S. Cl.** **D32/21**

(58) **Field of Classification Search** D32/18, D32/21, 23-24, 31; 15/319-321, 353, 347, 15/327.1-327.2, 327.4, 327.6-327.7, 329, 15/340.2; 55/DIG. 3, 375

See application file for complete search history.

(56) **References Cited**

U.S. PATENT DOCUMENTS

D219,752 S *	1/1971	Gantz et al.	D32/18
D325,453 S *	4/1992	Tsuge	D32/21
D352,146 S *	11/1994	Wulff	D32/24
D386,842 S *	11/1997	Hoshino et al.	D32/21
D418,643 S *	1/2000	Hoshino	D32/21
D435,322 S *	12/2000	DeBlasis et al.	D32/21
D462,488 S *	9/2002	Santiago et al.	D32/18
D467,693 S *	12/2002	Kitts	D32/21

D467,694 S *	12/2002	Kitts	D32/21
D496,764 S *	9/2004	Lopano	D32/21
D536,147 S *	1/2007	Medema et al.	D32/18
D537,216 S *	2/2007	Davis et al.	D32/18
D537,579 S *	2/2007	Zimmerle et al.	D32/21
D537,581 S *	2/2007	Zimmerle et al.	D32/21
D549,904 S *	8/2007	Eccardt et al.	D32/21
D564,154 S *	3/2008	Hollis et al.	D32/21
D577,164 S *	9/2008	Williams et al.	D32/21
D581,609 S *	11/2008	Conrad et al.	D32/21
D640,022 S *	6/2011	Paterson et al.	D32/21
D647,261 S *	10/2011	Schultz et al.	D32/21
D659,309 S *	5/2012	Benacquisto et al.	D32/18
D660,531 S *	5/2012	Benacquisto	D32/21

* cited by examiner

Primary Examiner — Ruth McInroy

(74) *Attorney, Agent, or Firm* — McGarry Bair PC

(57) **CLAIM**

The ornamental design for a deep cleaner, as shown and described.

DESCRIPTION

FIG. 1 is a front perspective view of a deep cleaner which embodies our design;

FIG. 2 is a front view thereof;

FIG. 3 is a rear view thereof;

FIG. 4 is a left side view thereof;

FIG. 5 is a right side view thereof; and,

FIG. 6 is a top plan view thereof.

The details shown in broken lines form no part of the claimed design.

1 Claim, 6 Drawing Sheets

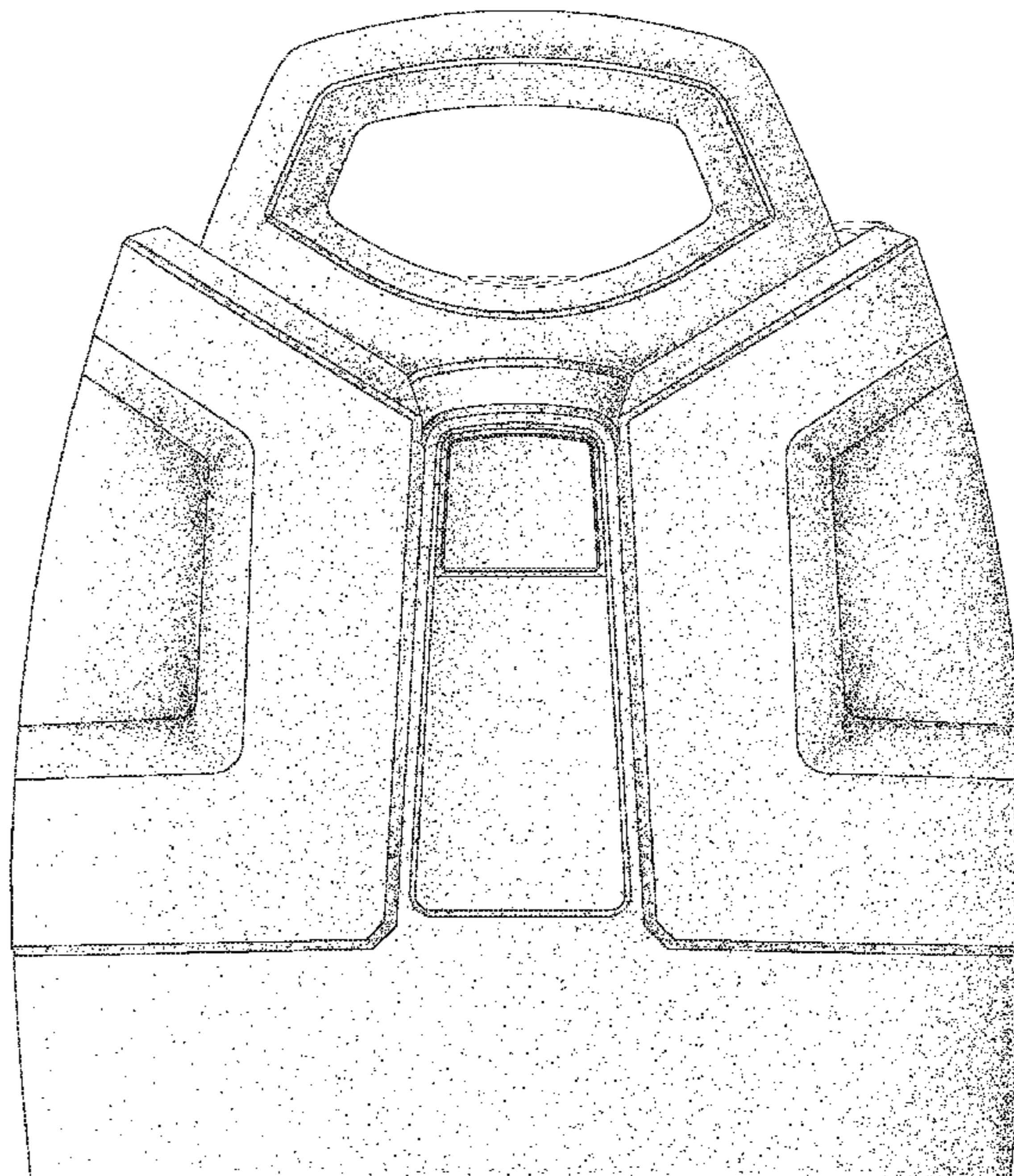
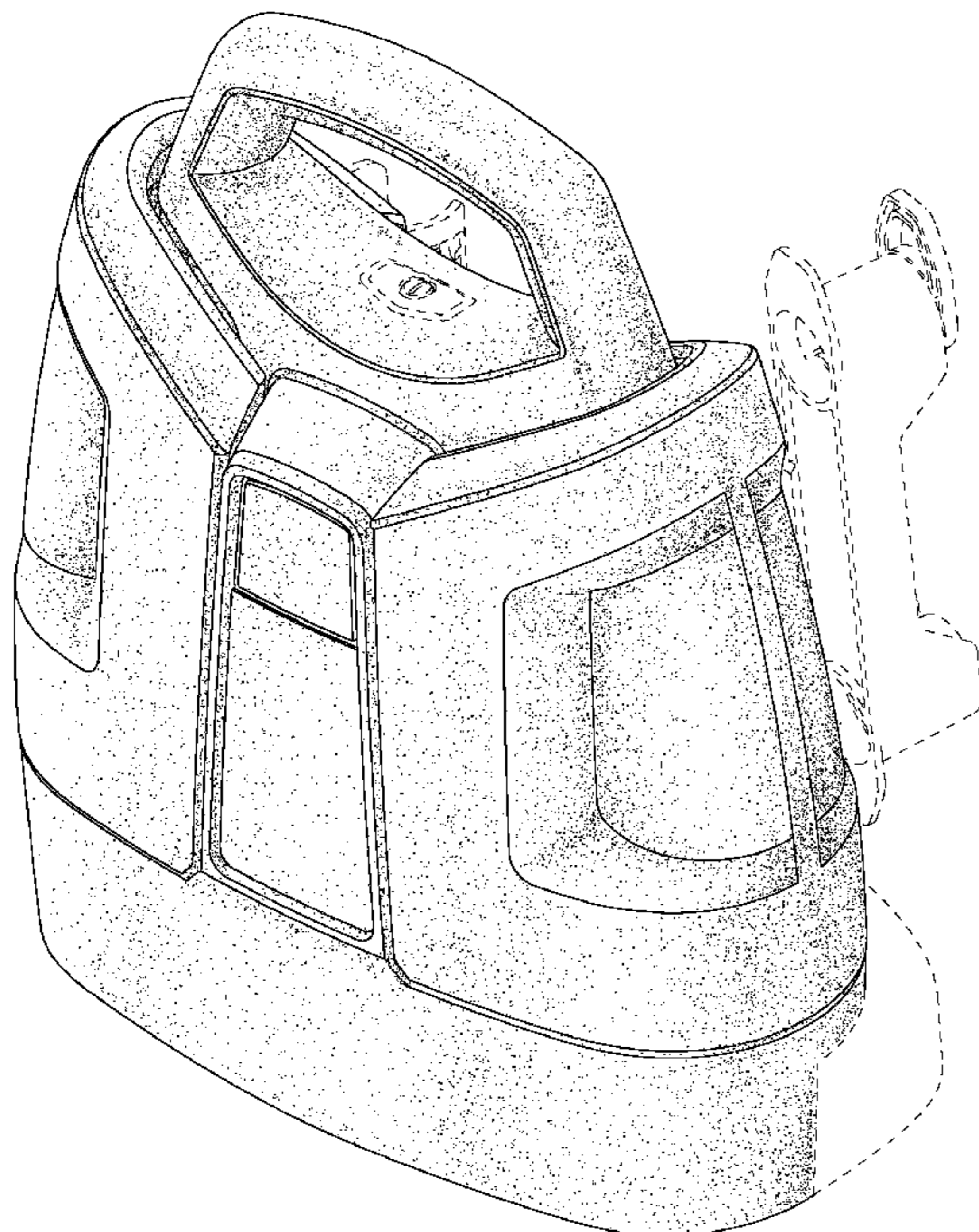

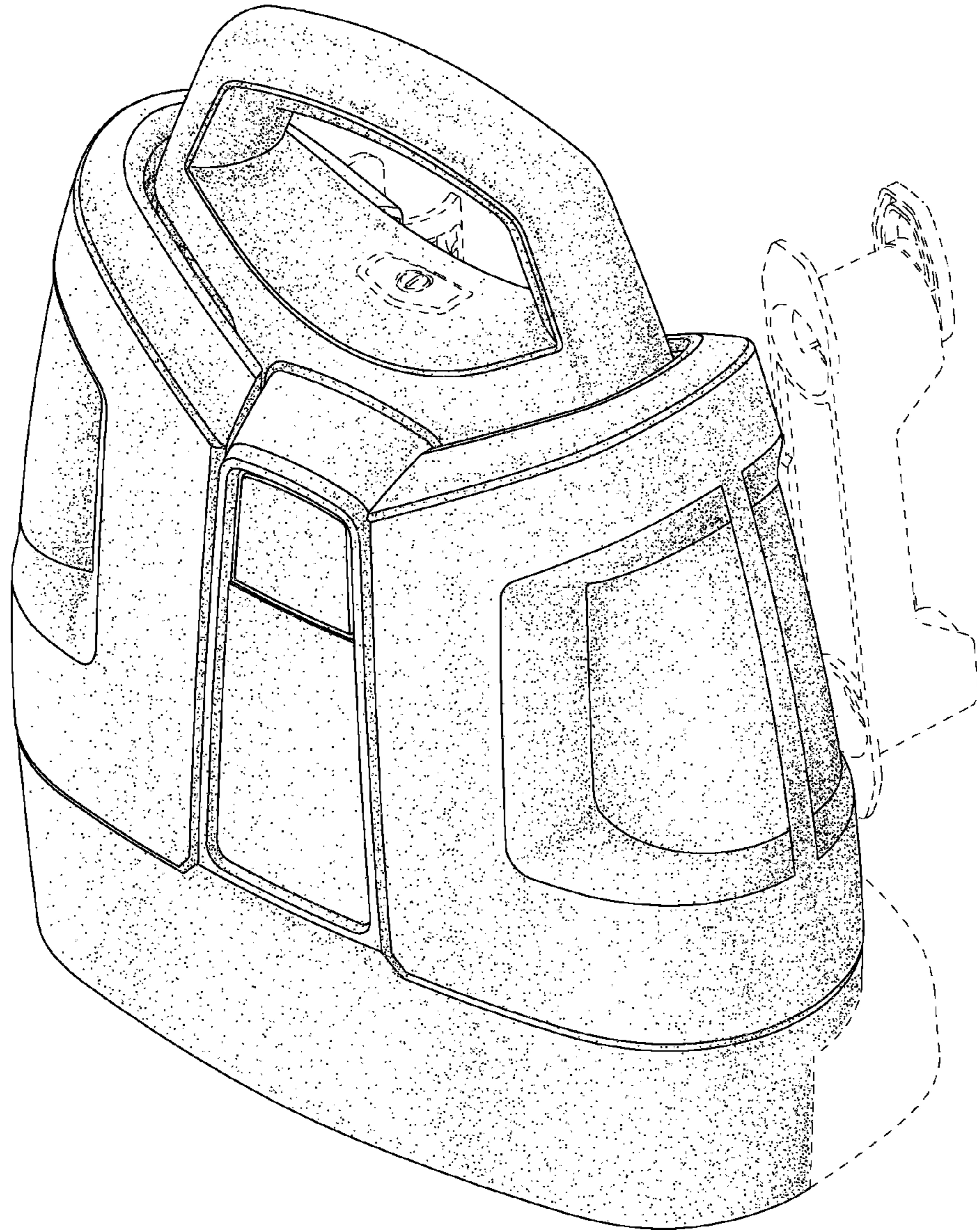

FIG. 1

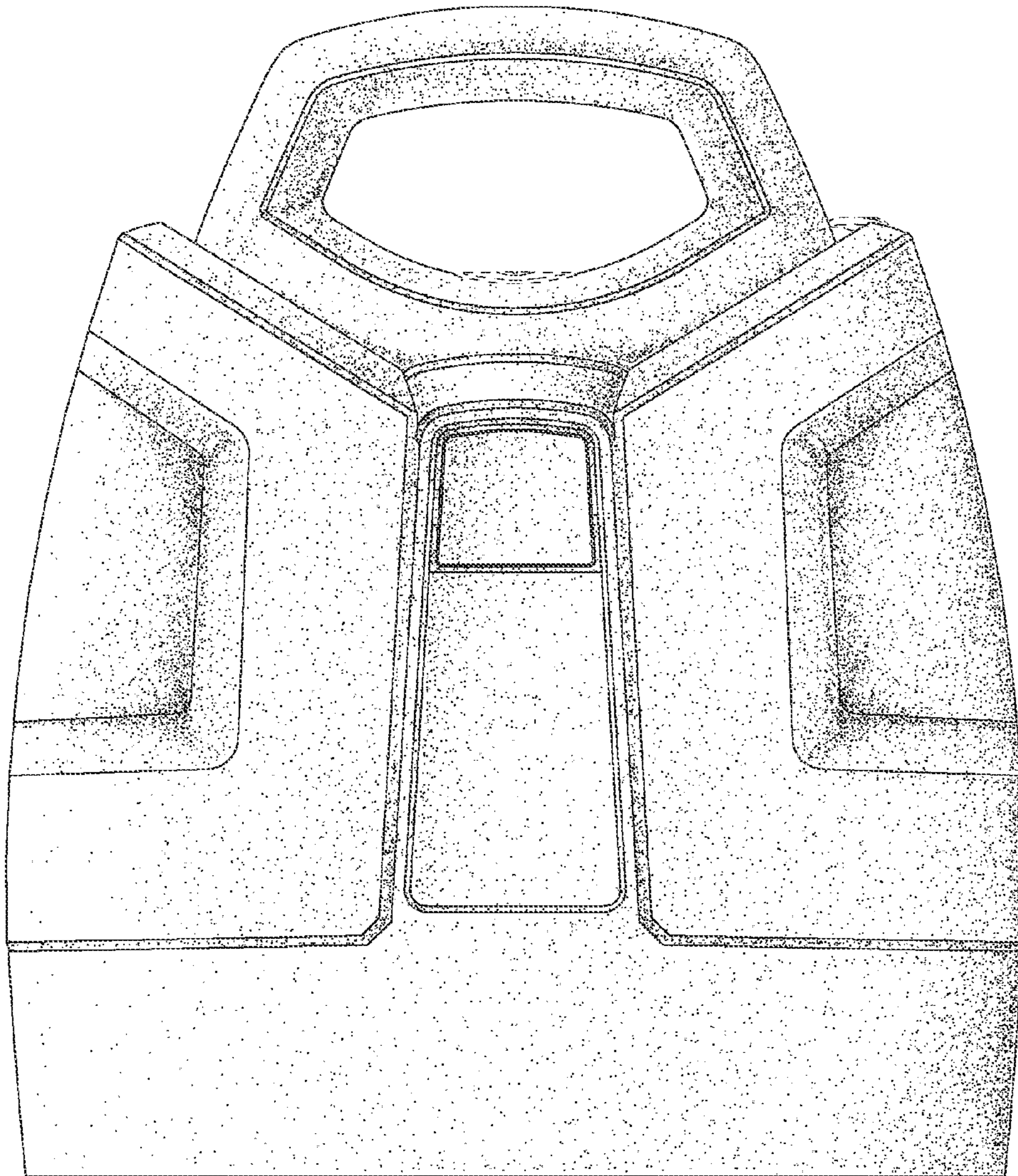

FIG. 2

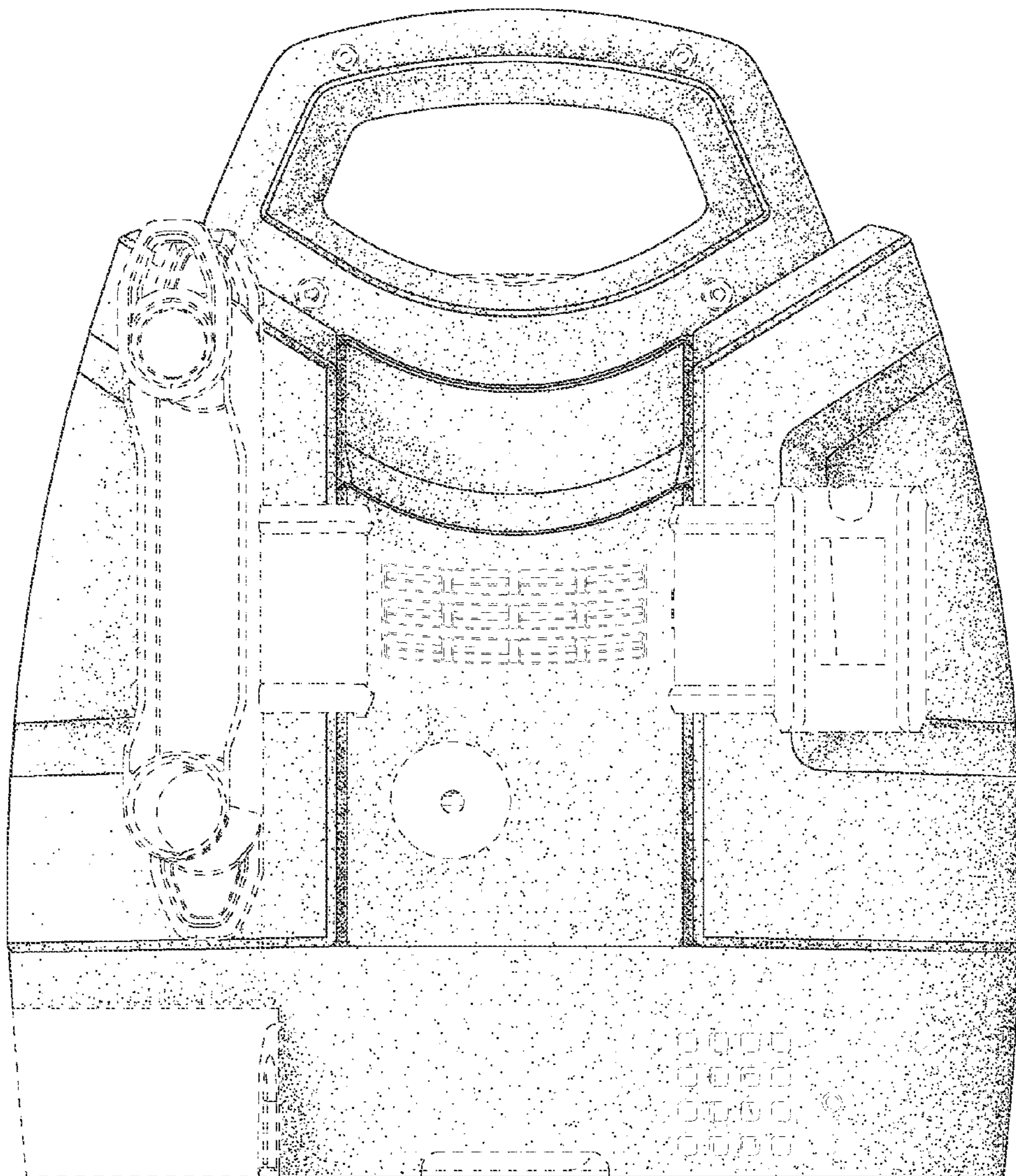

FIG. 3

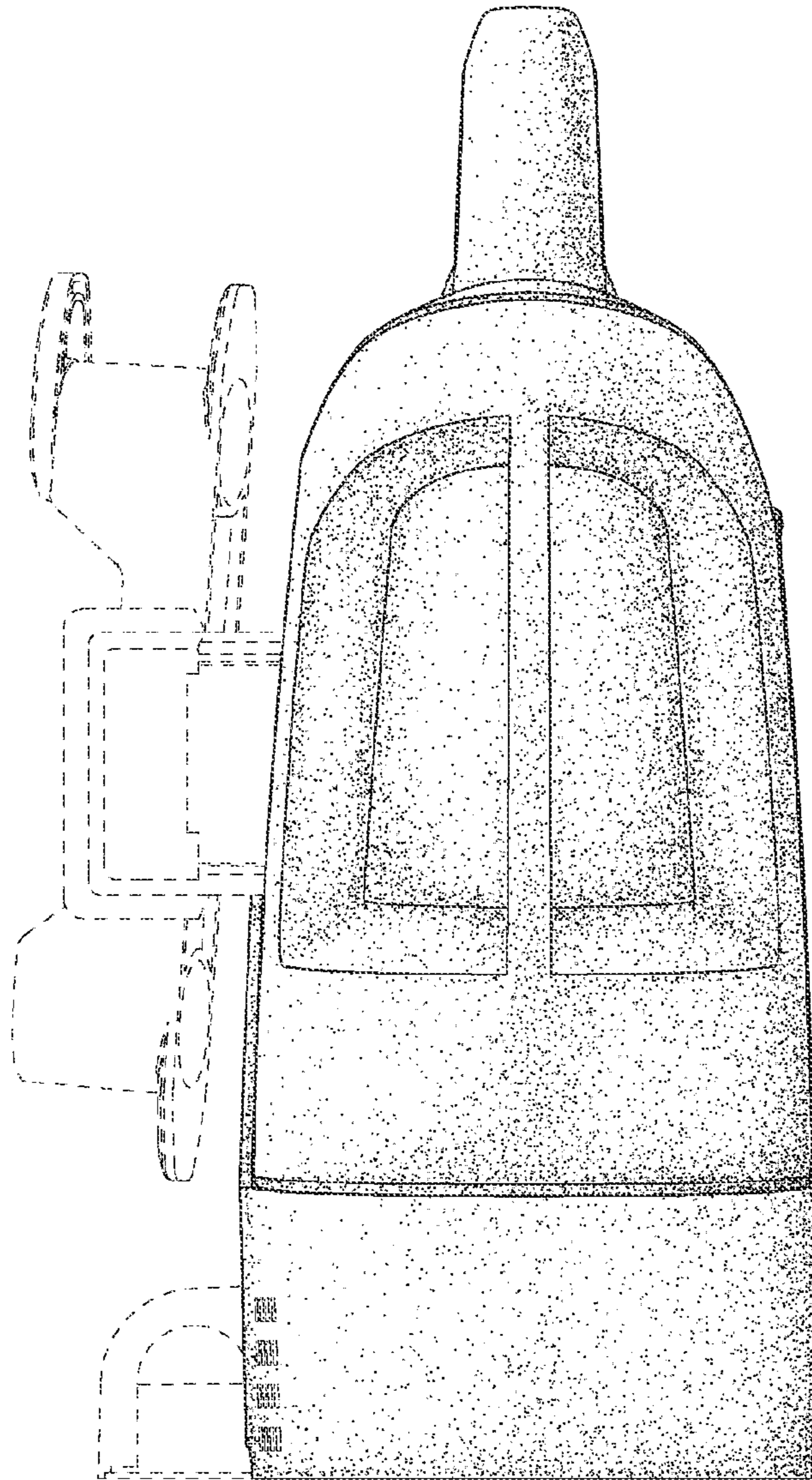

FIG. 4

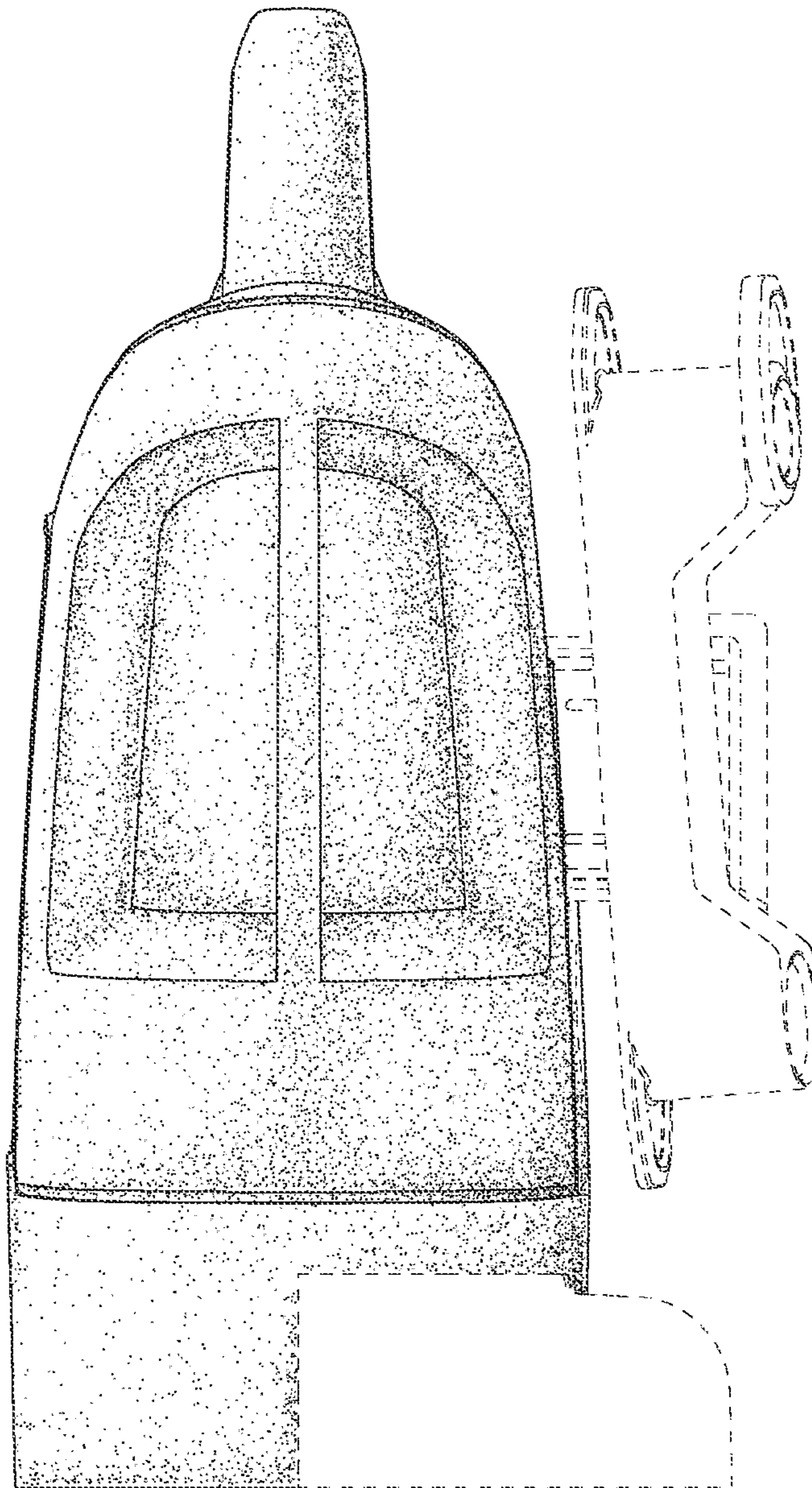

FIG. 5

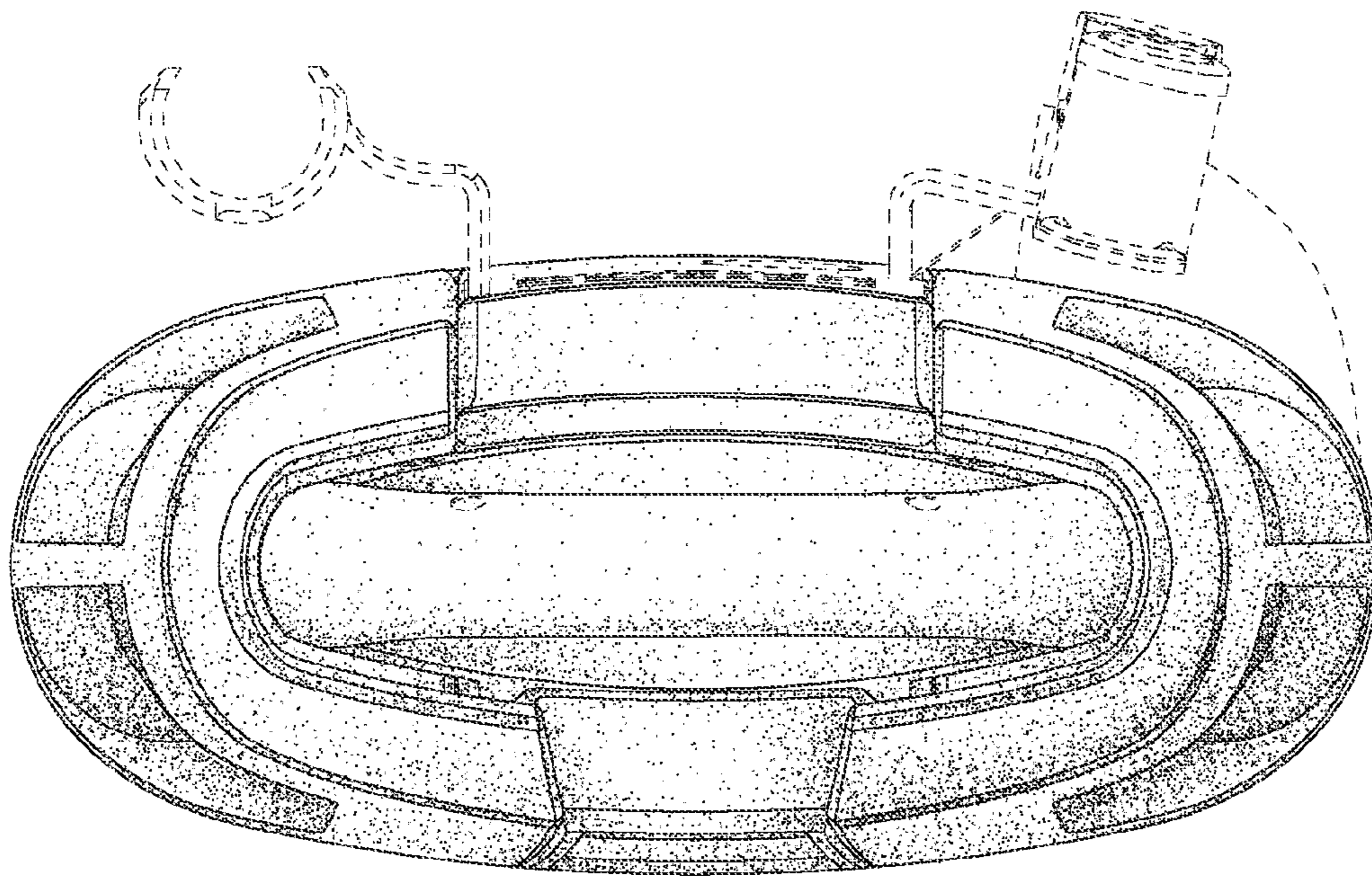

FIG. 6