



US00D675745S

(12) **United States Design Patent**
Nan

(10) **Patent No.:** **US D675,745 S**

(45) **Date of Patent:** **** Feb. 5, 2013**

(54) **MESSAGE APPARATUS**

(76) Inventor: **Simon Siu Man Nan**, Richmond Hill
(CA)

(**) Term: **14 Years**

(21) Appl. No.: **29/413,620**

(22) Filed: **Feb. 17, 2012**

(51) **LOC (9) Cl.** **28-03**

(52) **U.S. Cl.** **D24/215**

(58) **Field of Classification Search** D24/200,
D24/211–215, 141; 601/27, 28, 33, 40, 46,
601/47, 48, 63, 80, 99, 104, 112, 113, 114,
601/119, 122, 125, 129, 134, 135, 137, DIG. 12,
601/DIG. 13, DIG. 14, DIG. 15, DIG. 16,
601/DIG. 17

See application file for complete search history.

(56) **References Cited**

U.S. PATENT DOCUMENTS

D273,132 S * 3/1984 Moloff D24/214
D485,910 S * 1/2004 Chan D24/215
D613,417 S * 4/2010 Imboden et al. D24/215

D637,308 S * 5/2011 Imboden et al. D24/215
D643,128 S * 8/2011 Mohamed et al. D24/215
D643,933 S * 8/2011 Watabe D24/214
D648,862 S * 11/2011 Yen D24/215

* cited by examiner

Primary Examiner — Sandra Snapp

(74) *Attorney, Agent, or Firm* — Polsinelli Shughart PC

(57) **CLAIM**

The ornamental design for a massage apparatus, as shown and described.

DESCRIPTION

FIG. 1 is a perspective view of the massage apparatus showing my design;

FIG. 2 is a front view of the massage apparatus;

FIG. 3 is an opposing rear side view of the massage apparatus;

FIG. 4 is a left side view of the massage apparatus;

FIG. 5 is an opposing right side view of the massage apparatus;

FIG. 6 is a top view of the massage apparatus; and,

FIG. 7 is an opposing bottom view of the massage apparatus.

1 Claim, 2 Drawing Sheets

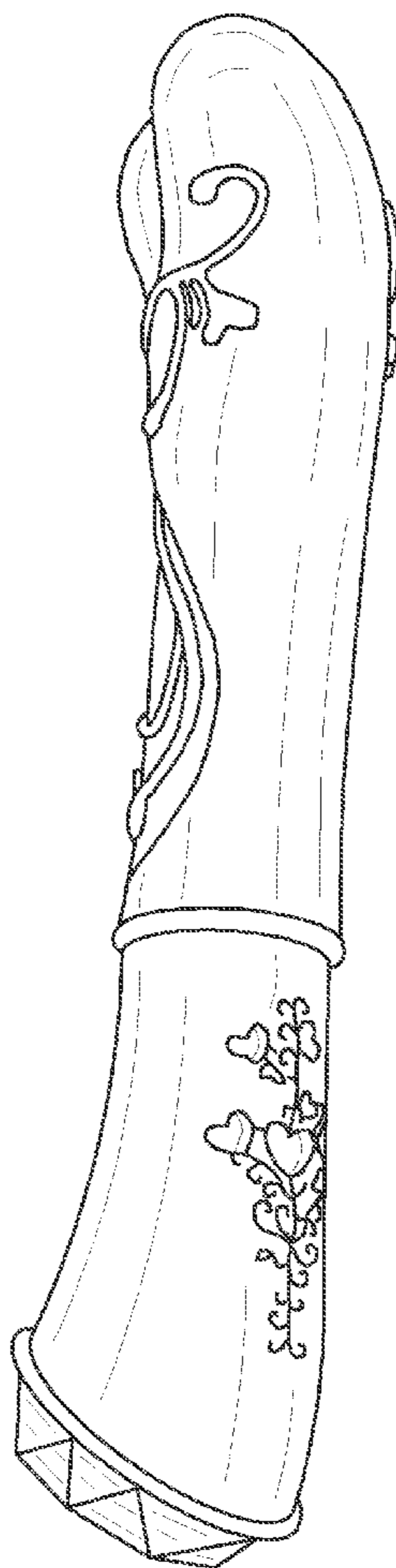

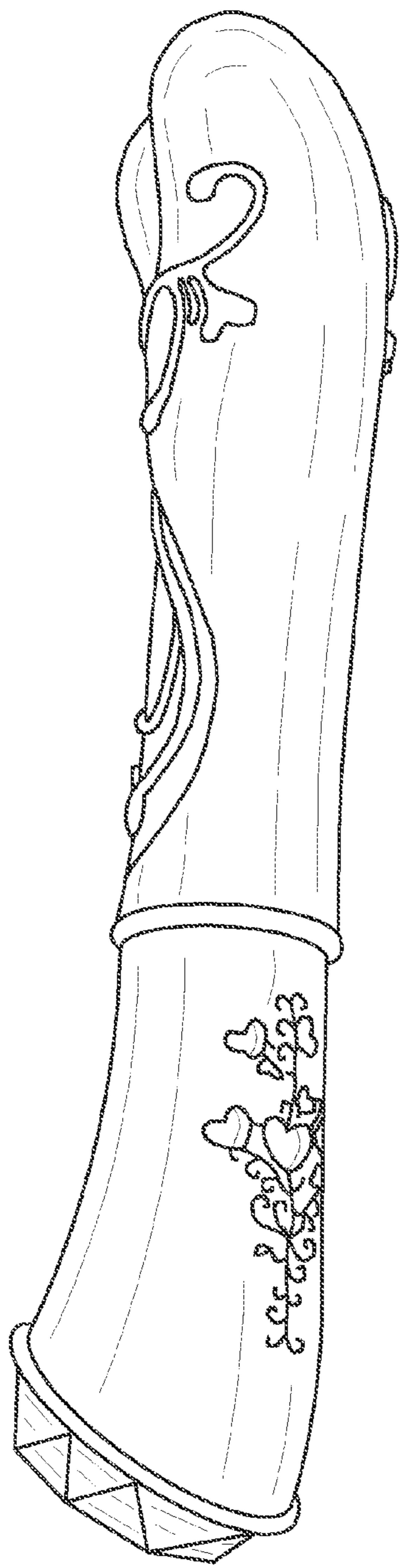

FIG. 1

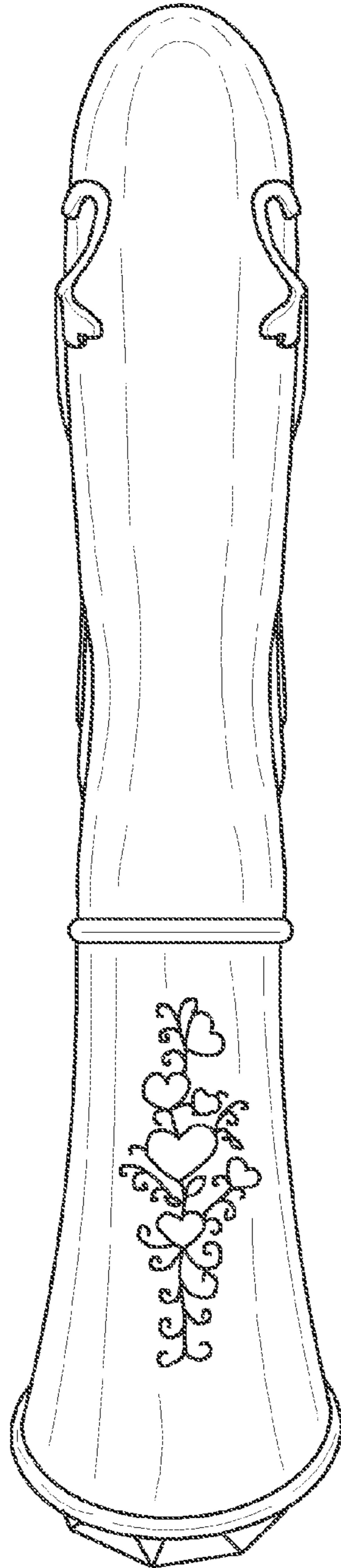

FIG. 2

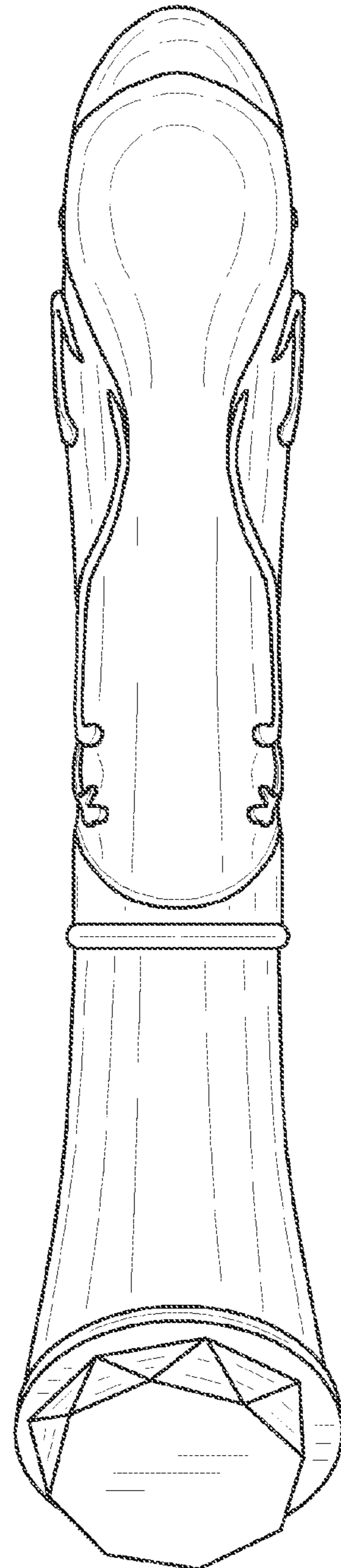

FIG. 3

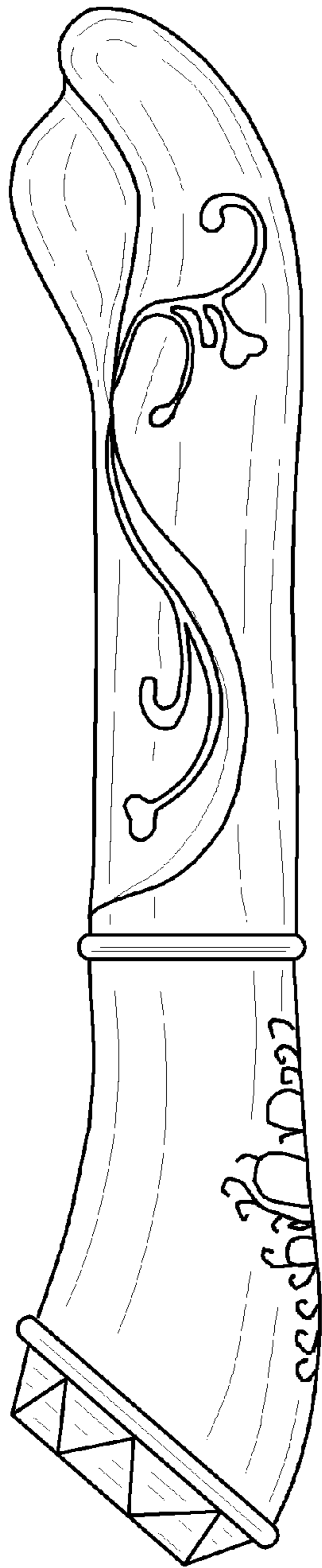

FIG. 4

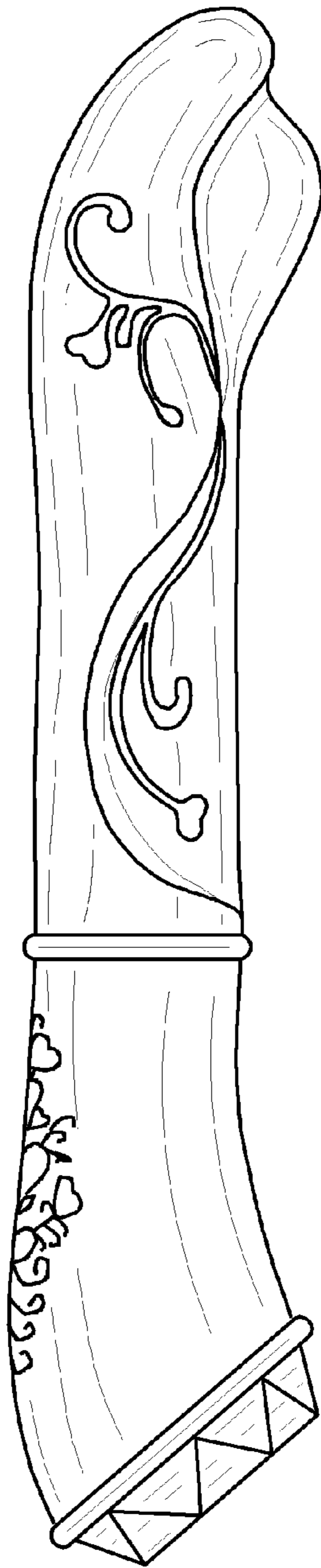

FIG. 5

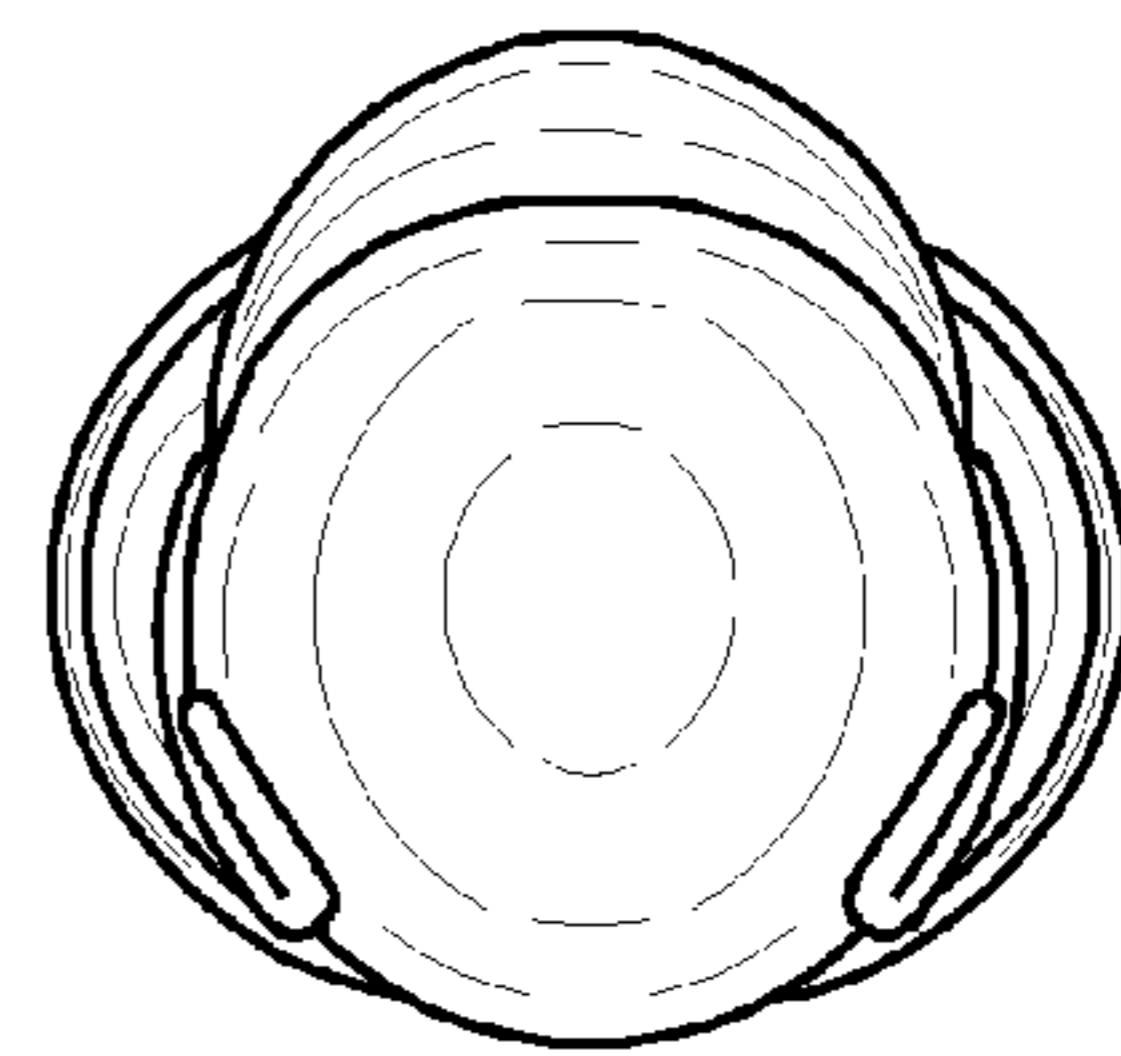

FIG. 6

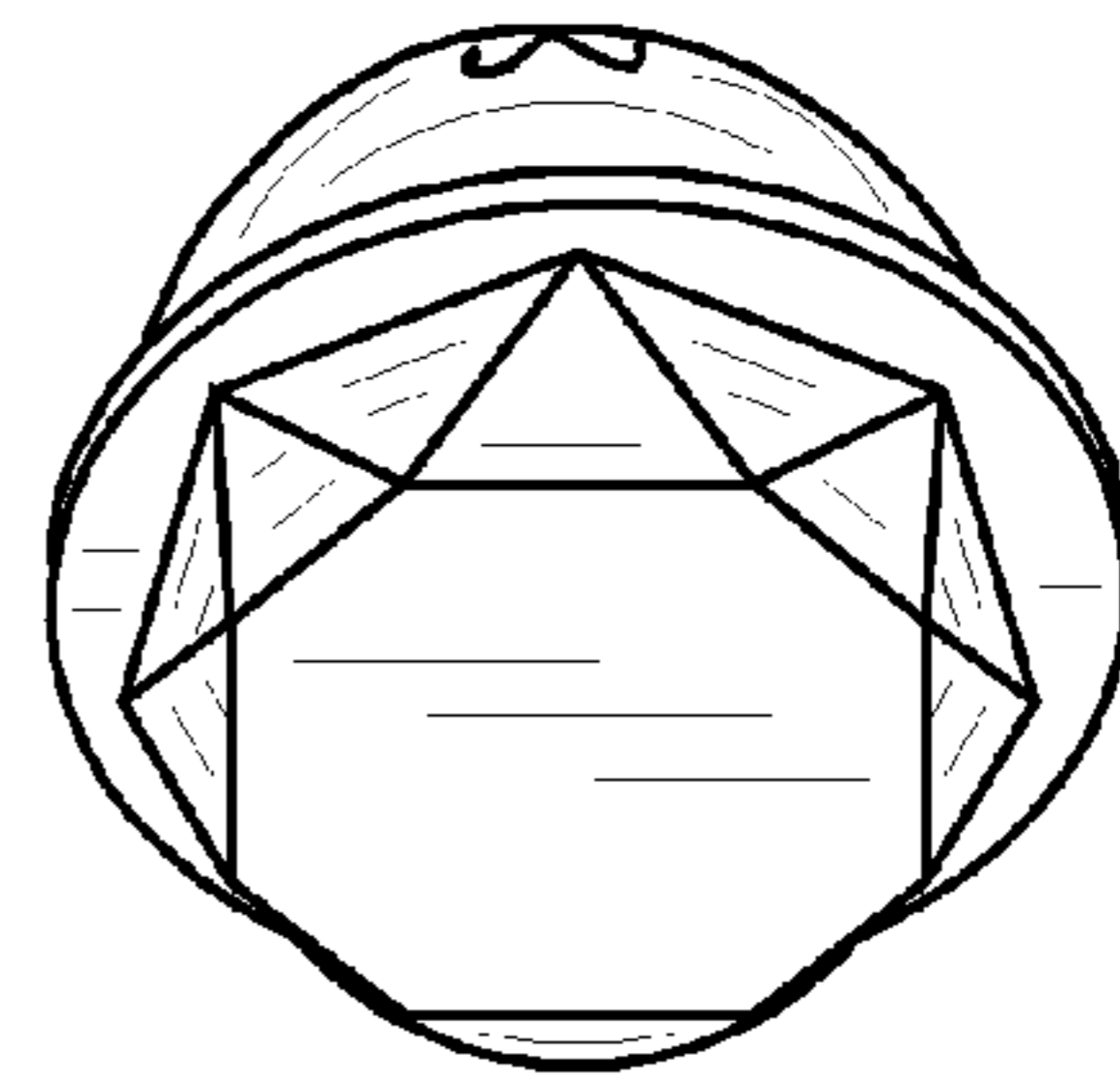

FIG. 7