



US00D675655S

(12) **United States Design Patent**
Leach

(10) **Patent No.:** **US D675,655 S**

(45) **Date of Patent:** **** Feb. 5, 2013**

(54) **CONTROL KNOB**

(75) **Inventor:** **Jason Karl Leach**, Cleveland, OH (US)

(73) **Assignee:** **Lincoln Global, Inc.**, City of Industry, CA (US)

(**) **Term:** **14 Years**

(21) **Appl. No.:** **29/392,804**

(22) **Filed:** **May 26, 2011**

(51) **LOC (9) Cl.** **15-09**

(52) **U.S. Cl.** **D15/144**

(58) **Field of Classification Search** D15/138,
D15/144, 144.1, 144.2; 70/14, 21, 22, 23,
70/51, 52, 258, 286, 431, 334, 332, 442-446;
72/348; 215/328; 401/117; 428/64
See application file for complete search history.

(56) **References Cited**

U.S. PATENT DOCUMENTS

D143,807 S *	2/1946	Eastham	D8/312
D173,885 S	1/1955	Slate		
D176,508 S *	1/1956	Enos	D8/311
D205,338 S	7/1966	Kilbourn		
D218,009 S	7/1970	Bosnick		
D251,965 S *	5/1979	Uyeda	D8/343
D252,208 S	6/1979	Ooya		
D268,905 S *	5/1983	Douglas	D9/531
D298,147 S *	10/1988	Tesla	D21/443
D329,590 S	9/1992	Chapman		
D341,129 S *	11/1993	McCormick	D13/168
D347,263 S *	5/1994	Phillips	D23/231
D381,881 S *	8/1997	Shaul et al.	D8/40
D390,197 S *	2/1998	Thomas	D13/174
D398,214 S	9/1998	Yui		
D416,060 S	11/1999	Angeles		
D423,514 S *	4/2000	Shindo	D14/240

D436,862 S *	1/2001	Witt et al.	D9/438
D438,193 S *	2/2001	Hakoda	D14/217
D472,947 S	4/2003	Wu		
D525,519 S	7/2006	Van Handel et al.		
D562,446 S *	2/2008	Chu et al.	D24/110.1
D575,711 S	8/2008	Johannsen		
D588,109 S *	3/2009	Miyazato	D14/217
D589,776 S	4/2009	Camp		
D600,094 S	9/2009	Hwang et al.		
D632,294 S *	2/2011	Frank et al.	D14/413
D632,944 S	2/2011	Kang		
2007/0181526 A1 *	8/2007	Frishman	215/257

* cited by examiner

Primary Examiner — Patricia Palasik

(74) *Attorney, Agent, or Firm* — Hahn Loeser & Parks, LLP;
Keith J. Marcinowski

(57) **CLAIM**

The ornamental design for a control knob, as shown and described.

DESCRIPTION

FIG. 1 is a perspective view of a control knob for a wire feeder;

FIG. 2 is a front perspective view of the control knob of FIG. 1;

FIG. 3 is a rear perspective view of the control knob of FIG. 1;

FIG. 4 is a bottom perspective view of the control knob of FIG. 1

FIG. 5 is a top plan view of control knob of FIG. 1;

FIG. 6 is a front elevational view of the control knob of FIG. 1; and,

FIG. 7 is a rear elevational view of the control knob of FIG. 1.

The broken lines shown in the figures are for illustrative purposes only and form no part of the claimed invention.

1 Claim, 4 Drawing Sheets

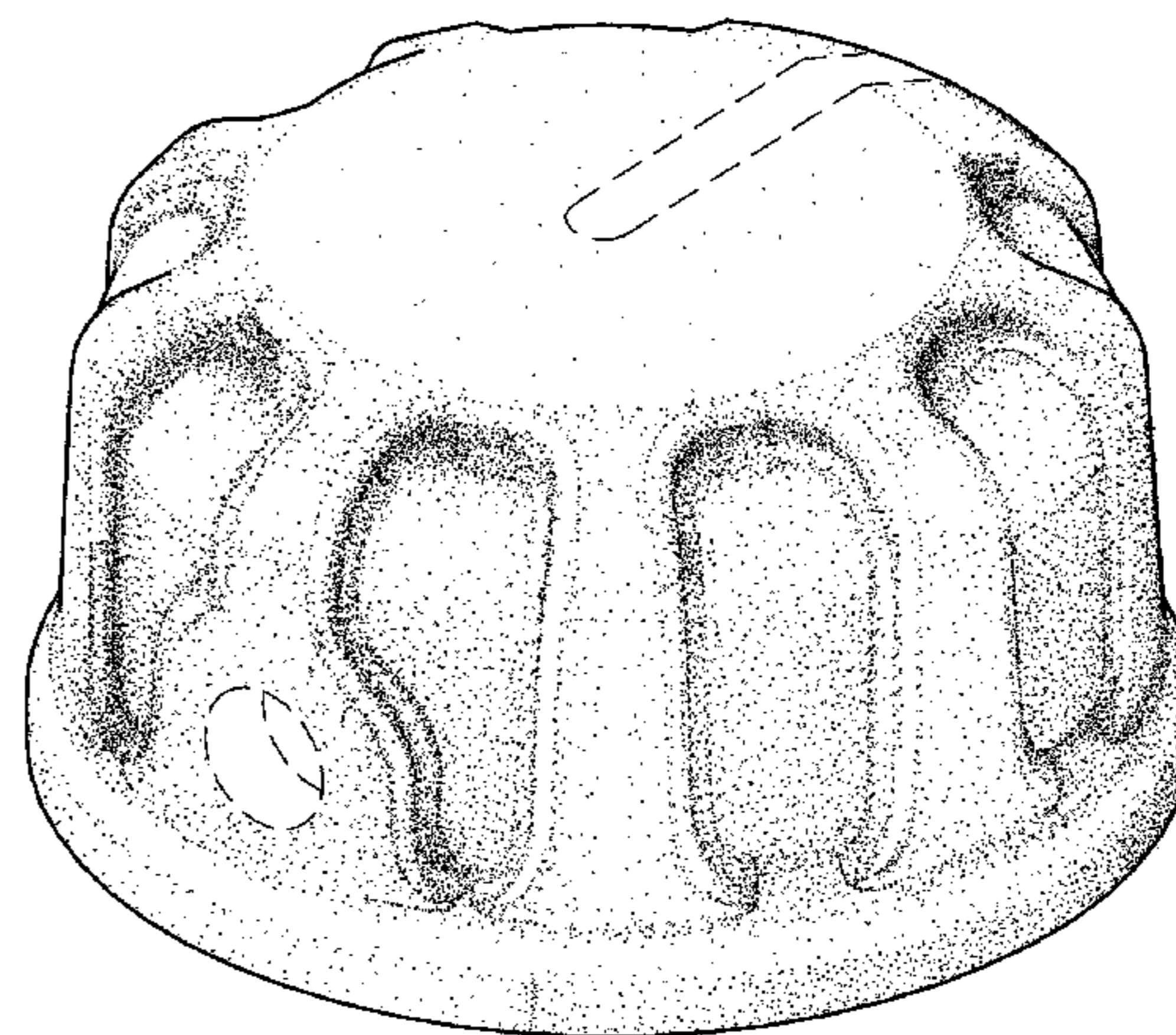
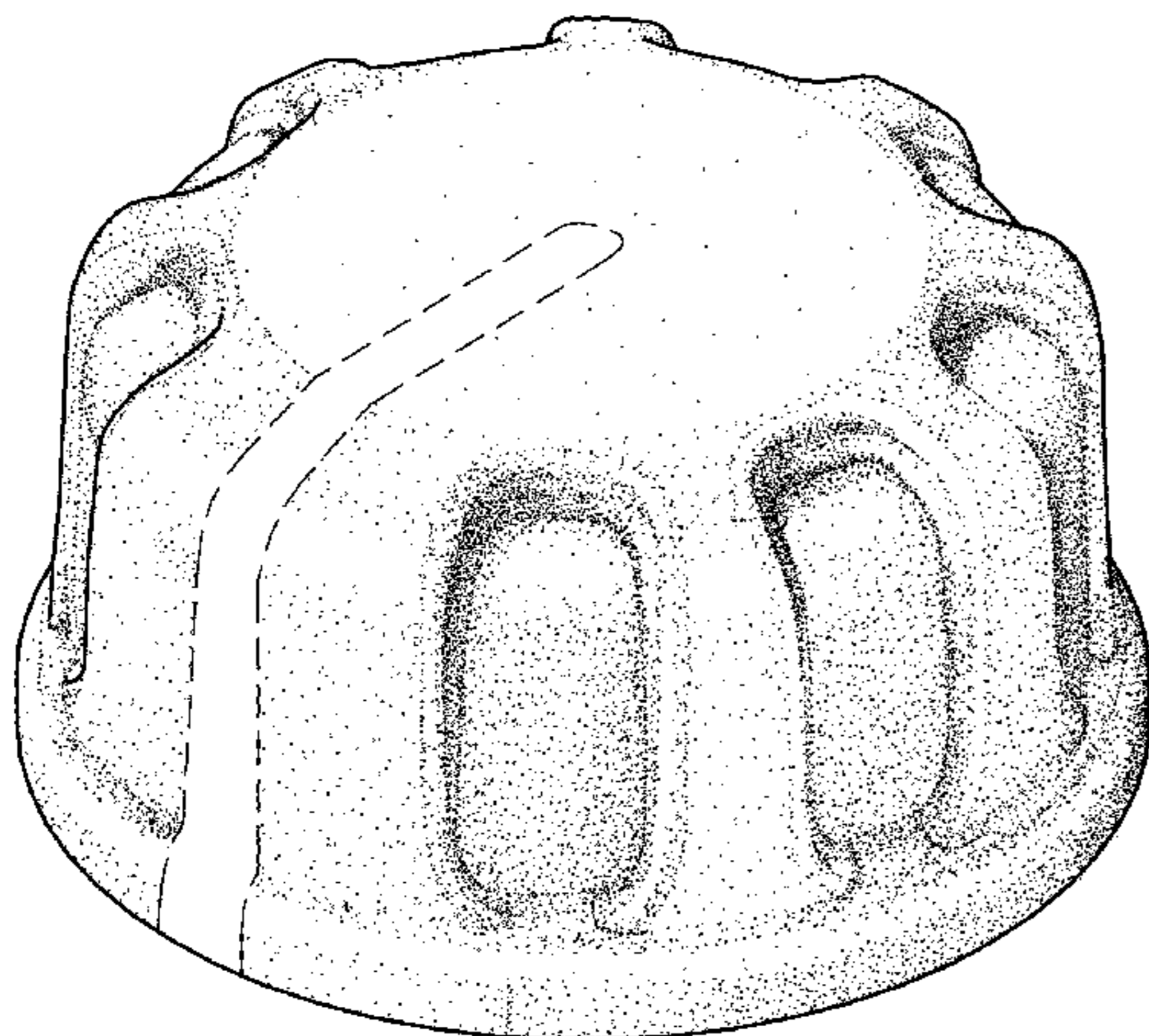

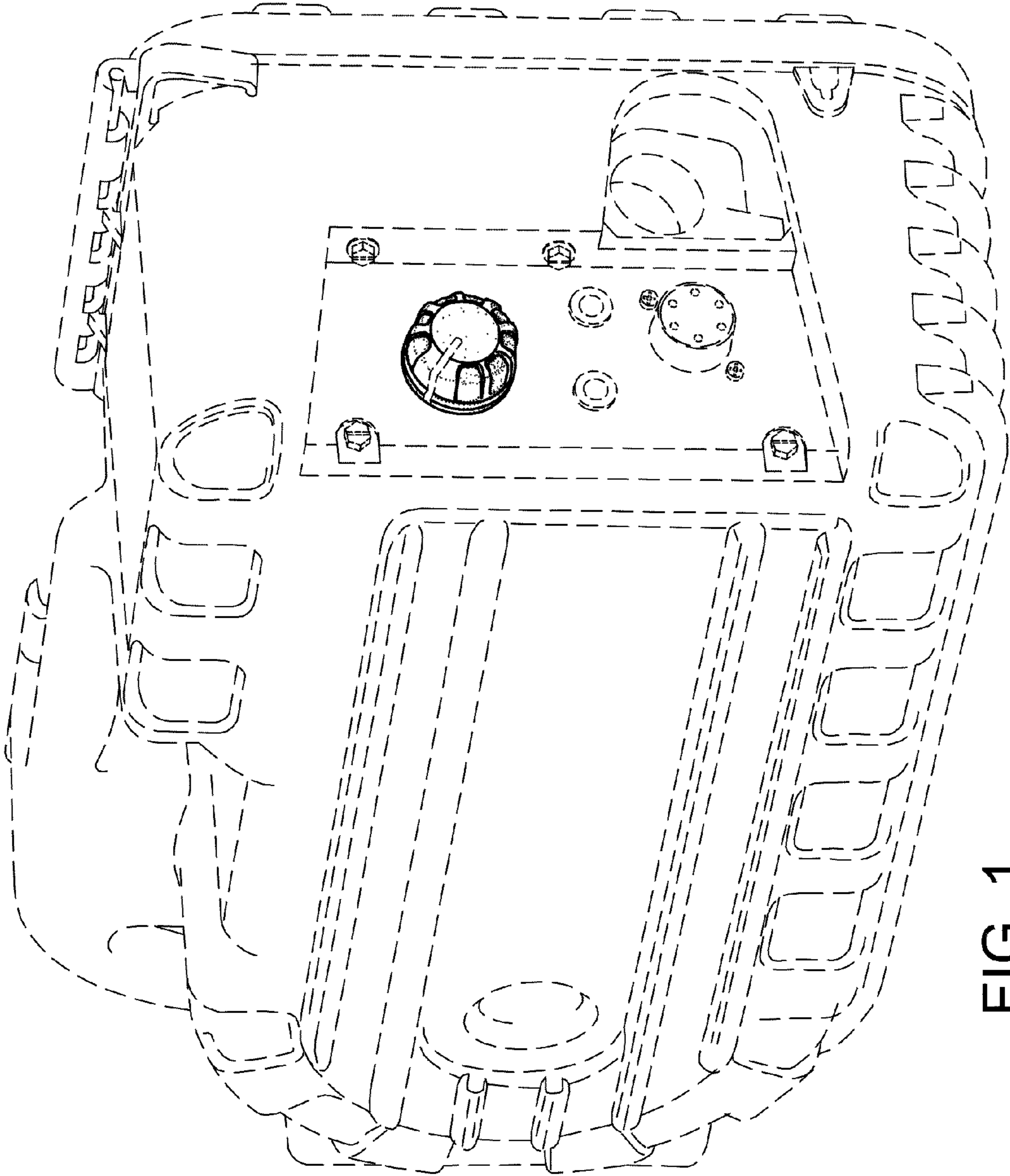

FIG. 1

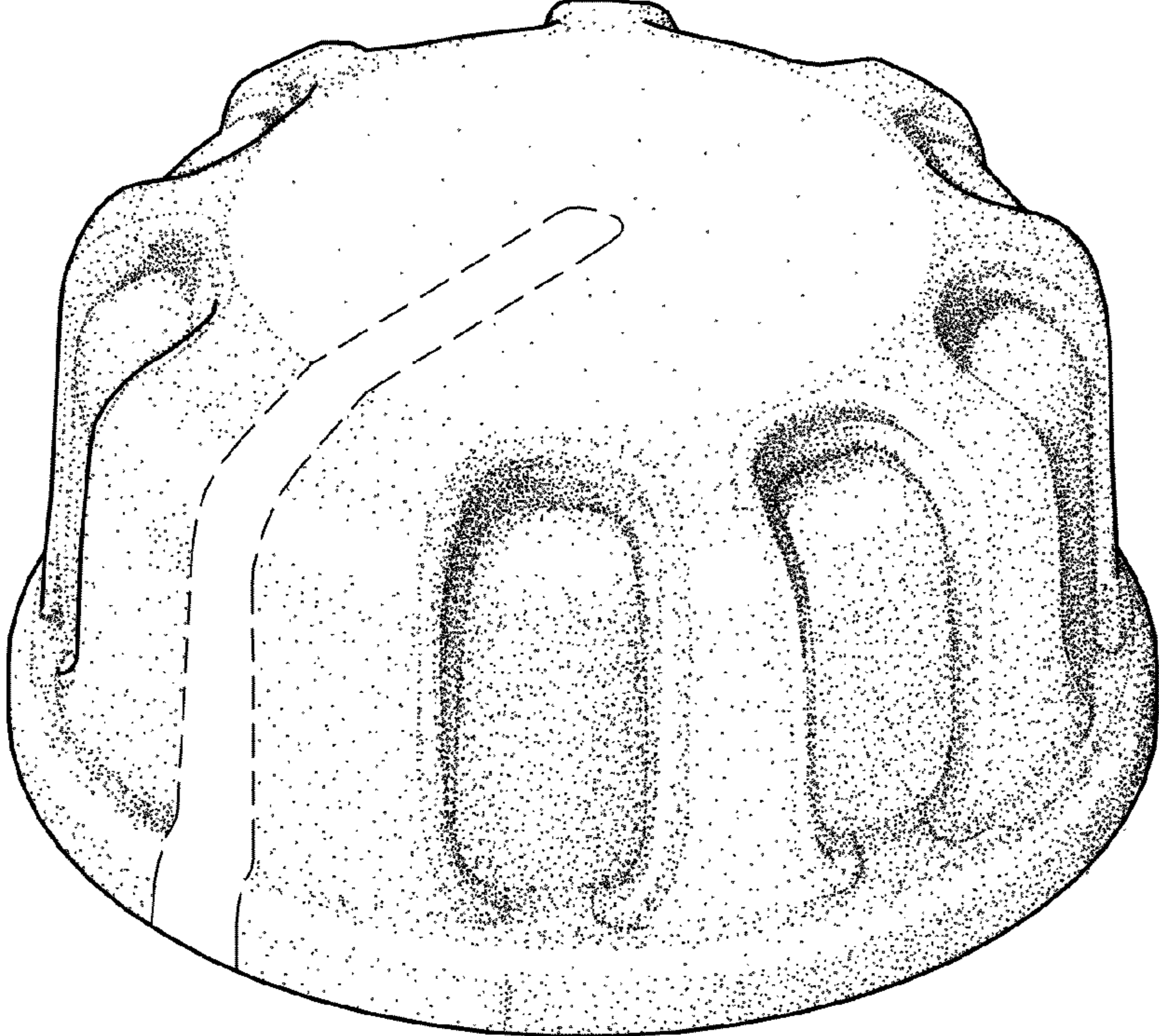

FIG. 2

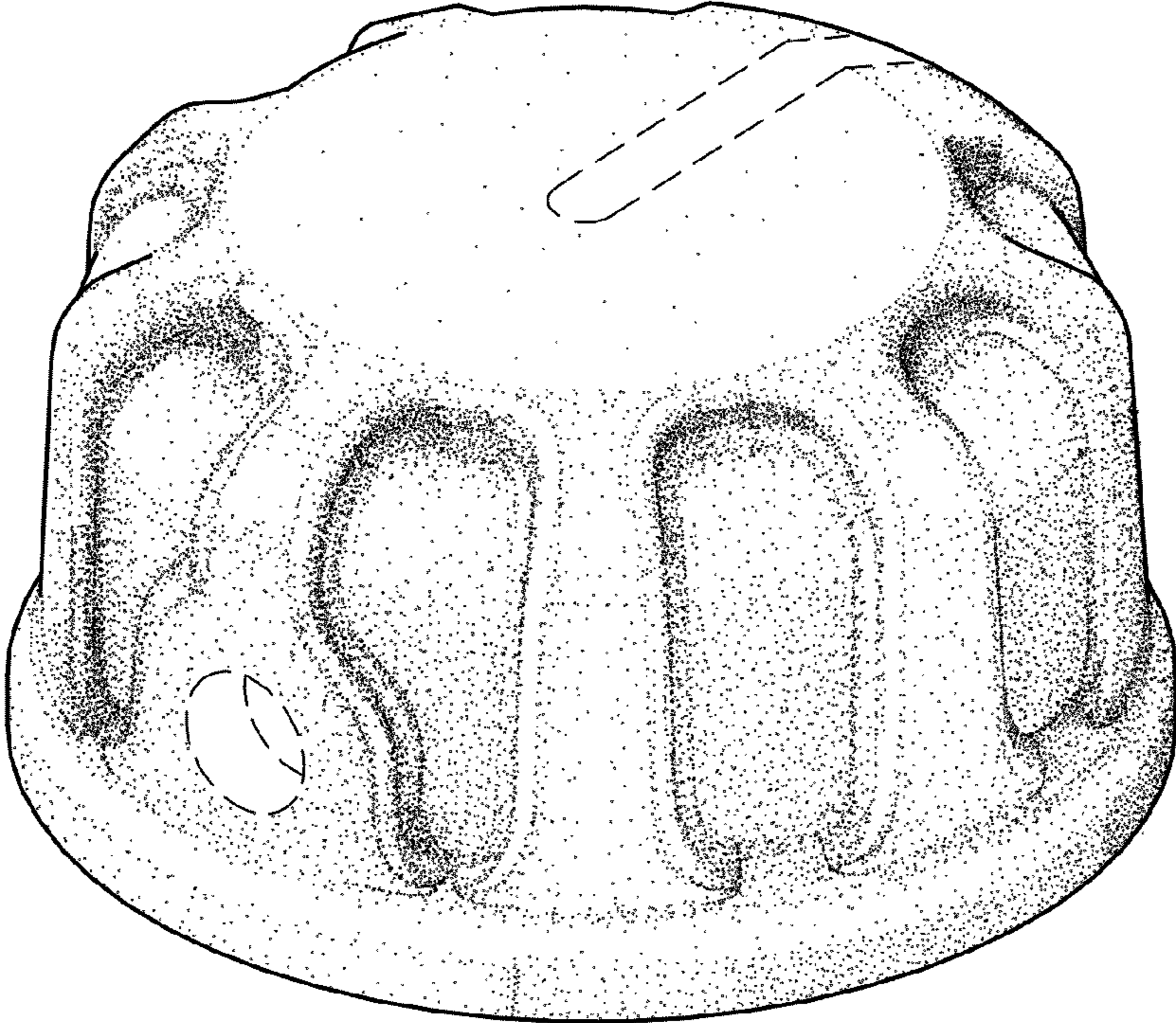

FIG. 3

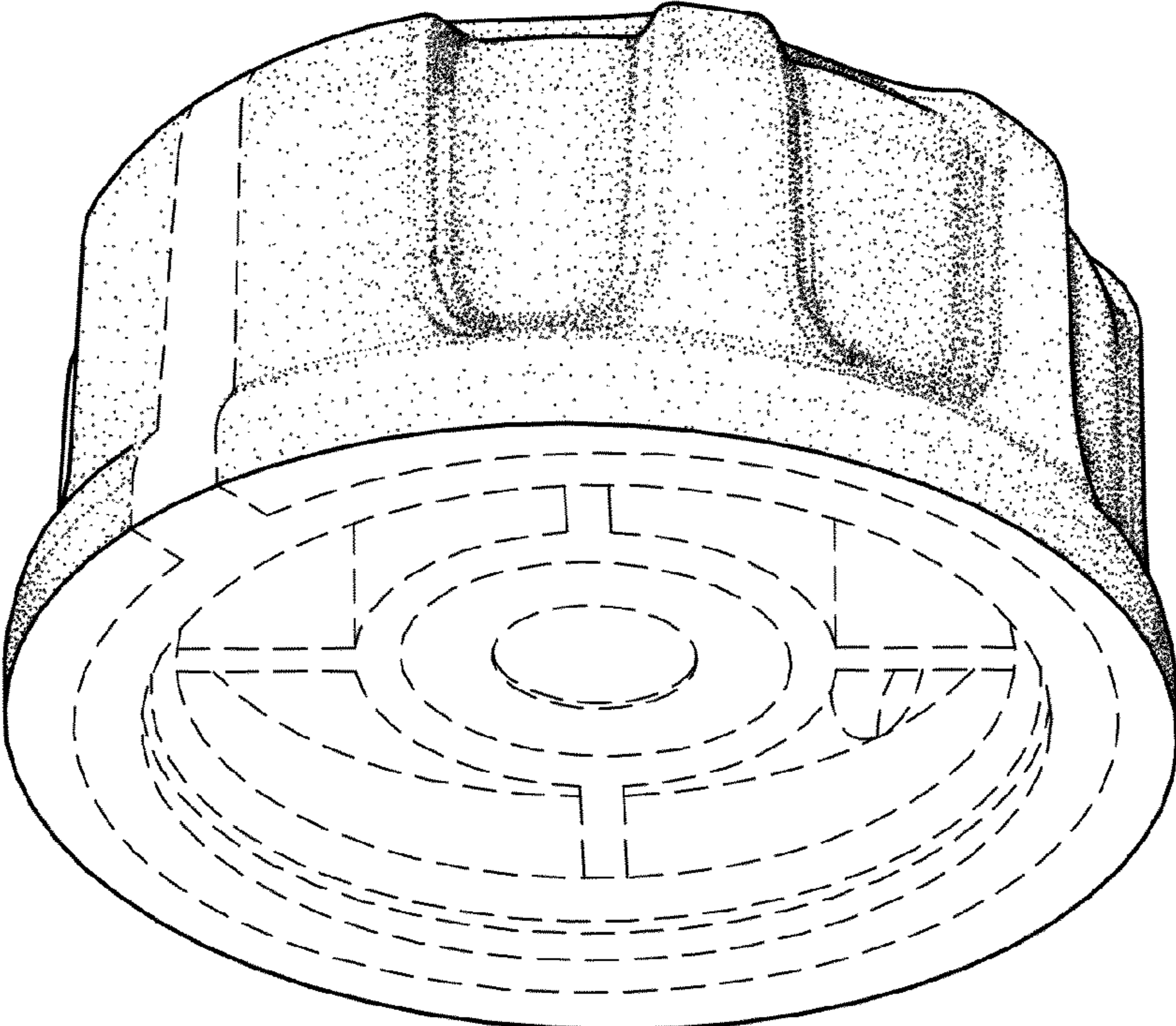

FIG. 4

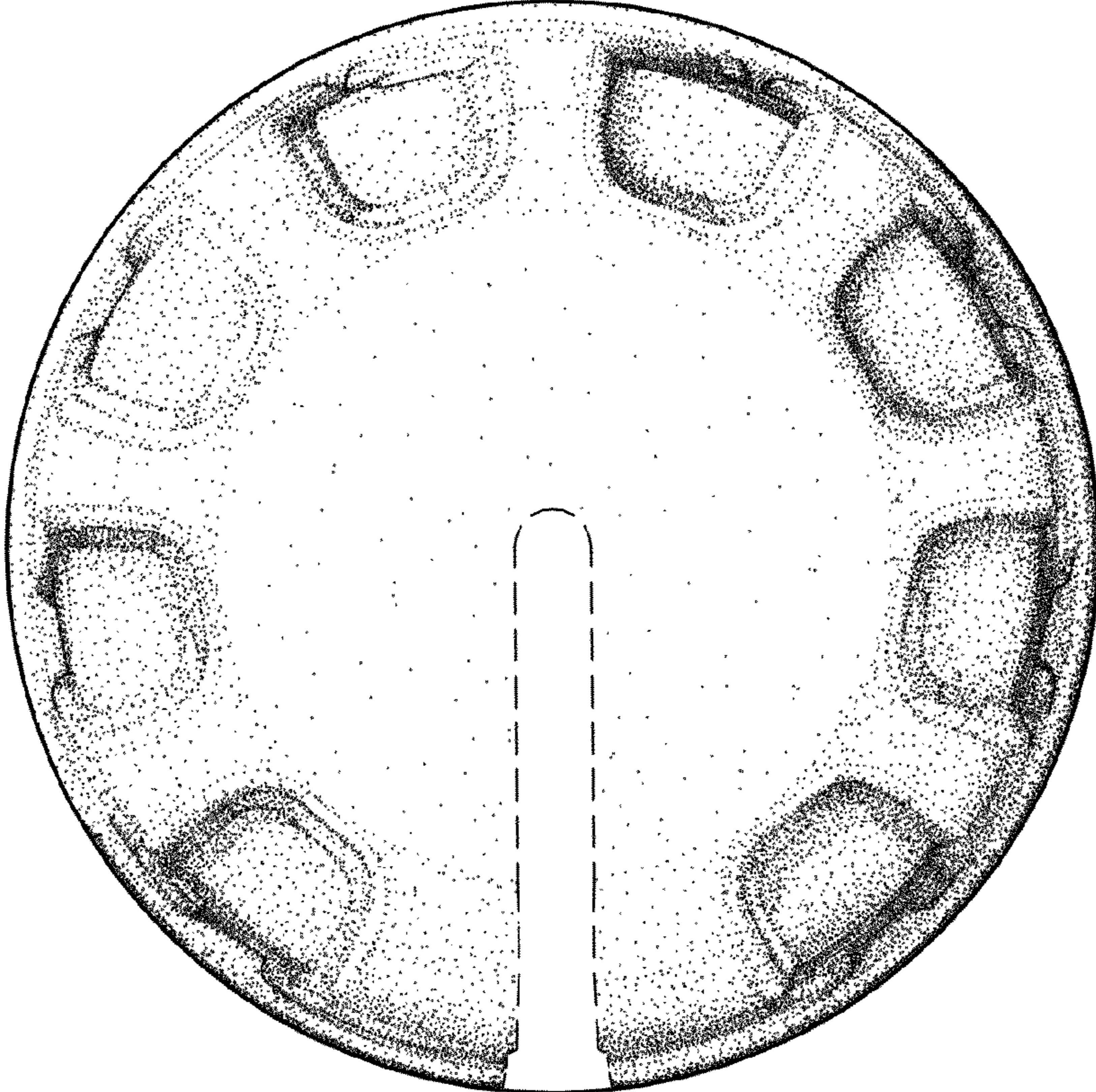

FIG. 5

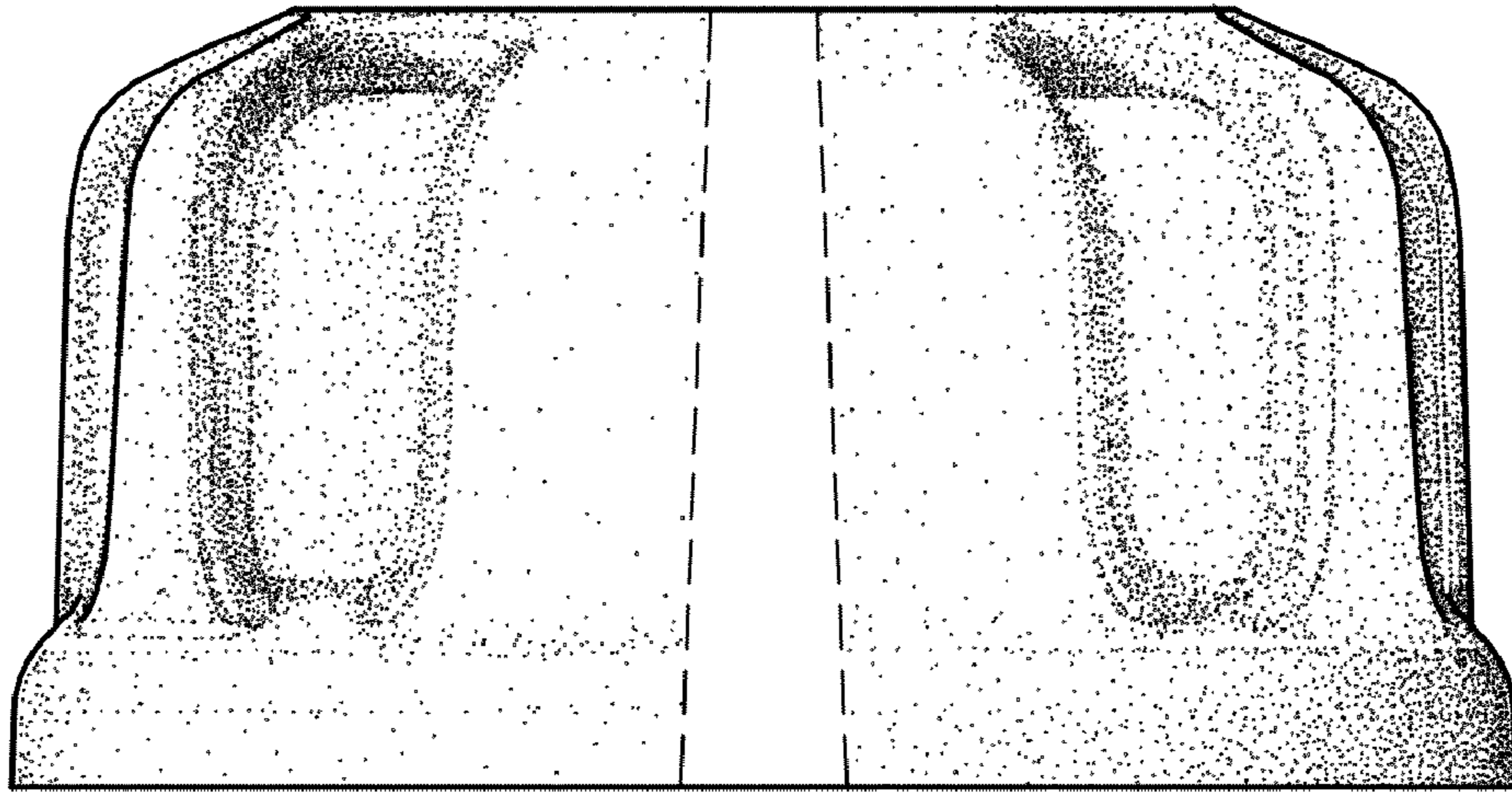

FIG. 6

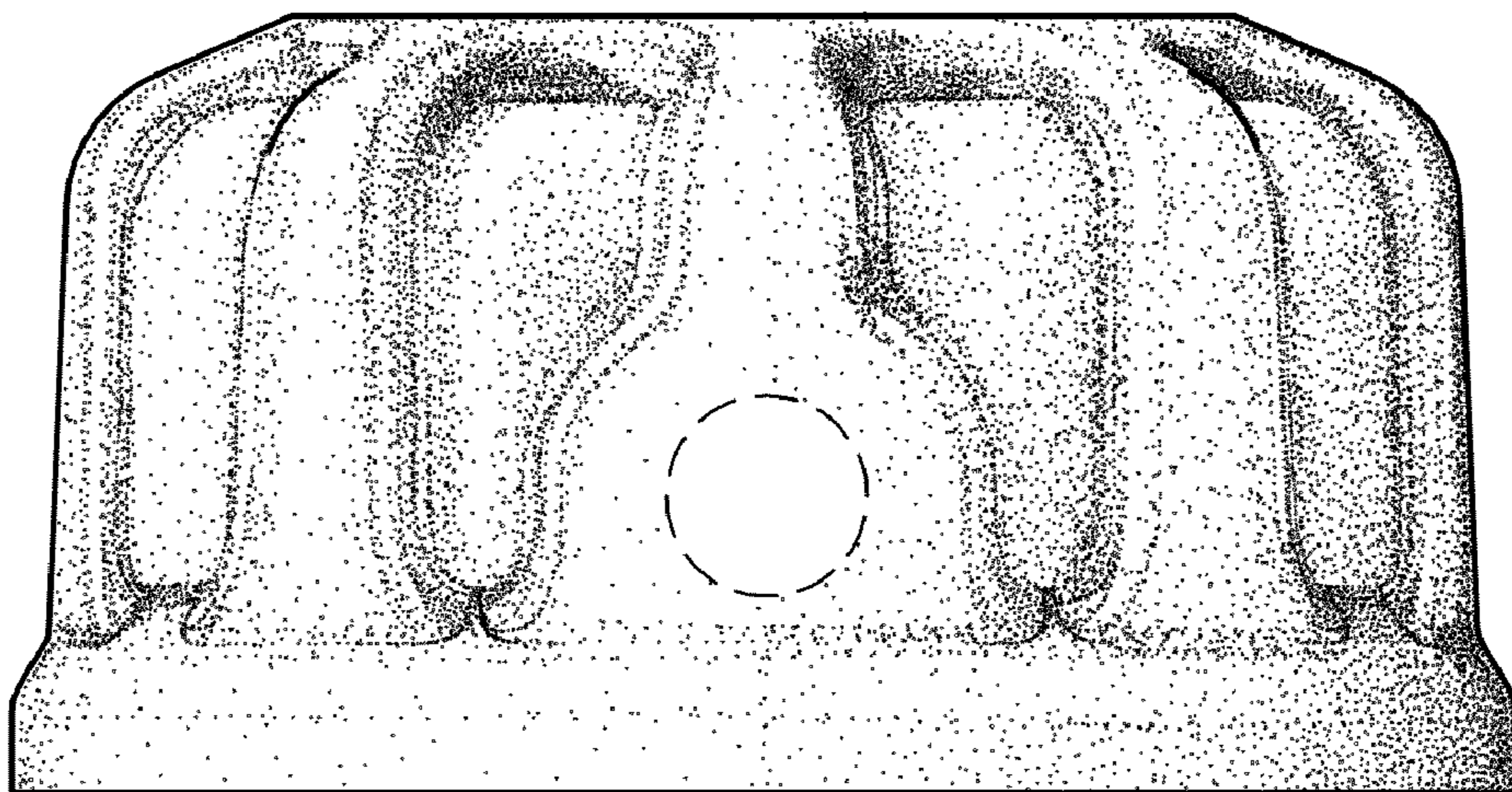

FIG. 7