



US00D675593S

(12) **United States Design Patent**
Ogura

(10) **Patent No.:** **US D675,593 S**

(45) **Date of Patent:** **** Feb. 5, 2013**

(54) **AUDIO HEAD UNIT**

(75) Inventor: **Haruka Ogura**, Higashimurayama (JP)

(73) Assignee: **Clarion Co., Ltd.**, Saitama (JP)

(**) Term: **14 Years**

(21) Appl. No.: **29/414,971**

(22) Filed: **Mar. 6, 2012**

(30) **Foreign Application Priority Data**

Dec. 19, 2011 (JP) 2011-029356

(51) **LOC (9) Cl.** **14-03**

(52) **U.S. Cl.** **D14/157**

(58) **Field of Classification Search** D14/131,
D14/132, 137, 155, 157, 168-171, 188, 194,
D14/197, 198, 239, 257, 258, 496, 498-508;
455/90.1-90.3, 344-355; 369/6-12
See application file for complete search history.

(56) **References Cited**

U.S. PATENT DOCUMENTS

D389,841 S * 1/1998 Tokiyama et al. D14/258
D515,547 S * 2/2006 Mizokawa et al. D14/157
D530,305 S * 10/2006 Kaner et al. D14/258

D531,163 S * 10/2006 Kaner et al. D14/258
D532,006 S * 11/2006 Kim D14/258
D532,007 S * 11/2006 Park D14/258
D553,643 S * 10/2007 Nemoto D14/496
D554,088 S * 10/2007 Matsumoto D14/505
D571,780 S * 6/2008 Tan et al. D14/188
D587,674 S * 3/2009 Uehara et al. D14/157
D594,452 S * 6/2009 Katsuno D14/157

* cited by examiner

Primary Examiner — Keli L Hill

(74) *Attorney, Agent, or Firm* — Oliff & Berridge, PLC

(57) **CLAIM**

The ornamental design for an audio head unit, as shown and described.

DESCRIPTION

FIG. 1 is a perspective view of an audio head unit;
FIG. 2 is a front view thereof;
FIG. 3 is a top view thereof;
FIG. 4 is a right-side view thereof;
FIG. 5 is a left-side view thereof;
FIG. 6 is a rear view thereof; and,
FIG. 7 is a bottom view thereof.

The broken lines depict unclaimed subject matter only and form no part of the claimed design.

1 Claim, 6 Drawing Sheets

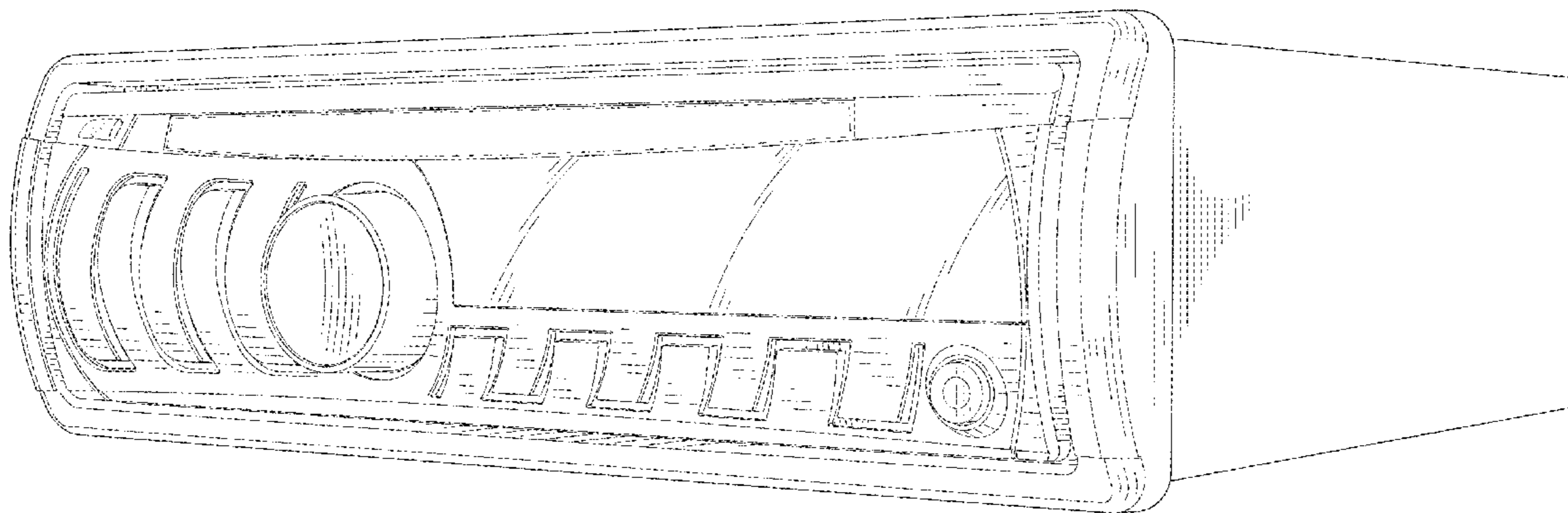

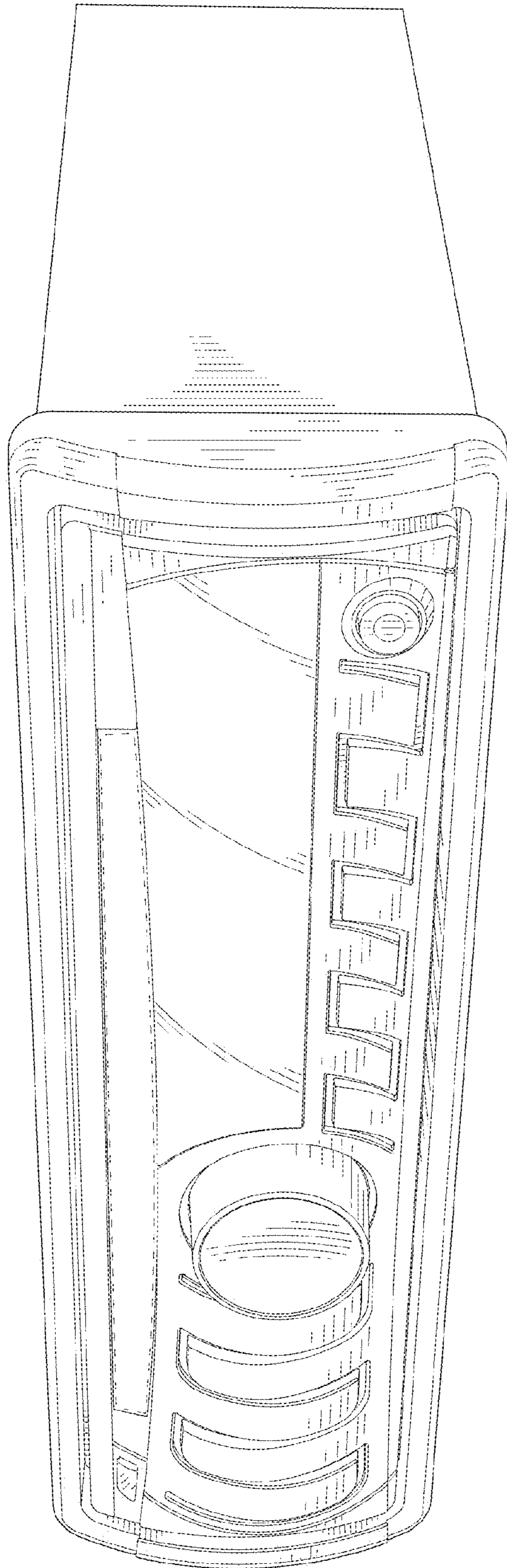

FIG. 1

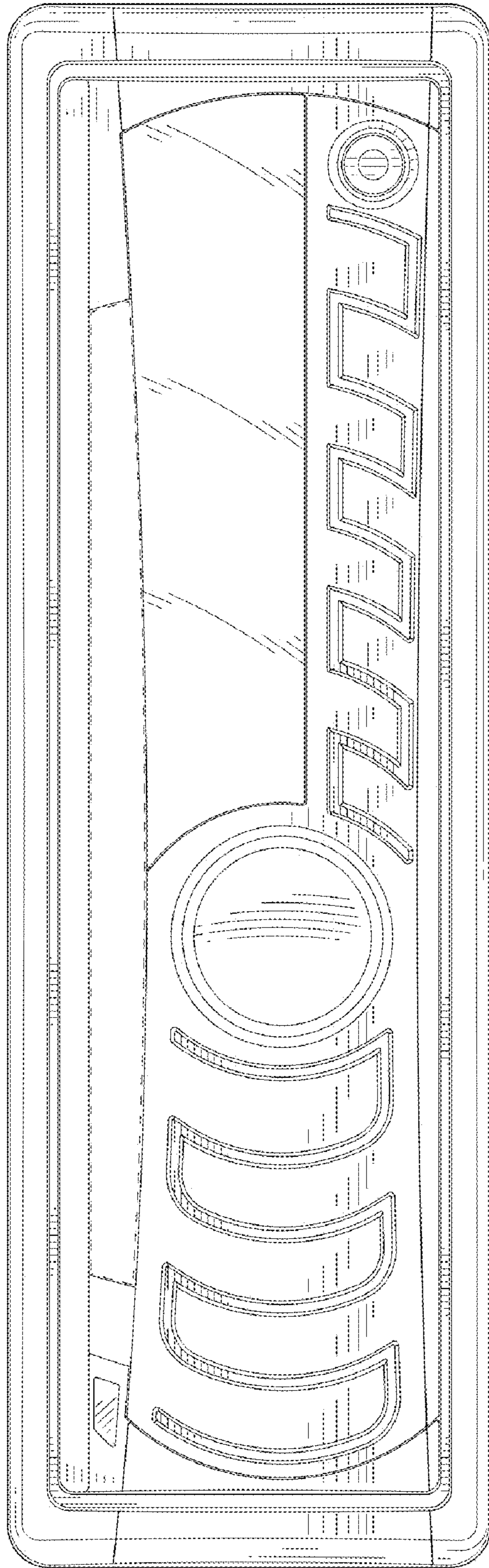

FIG. 2

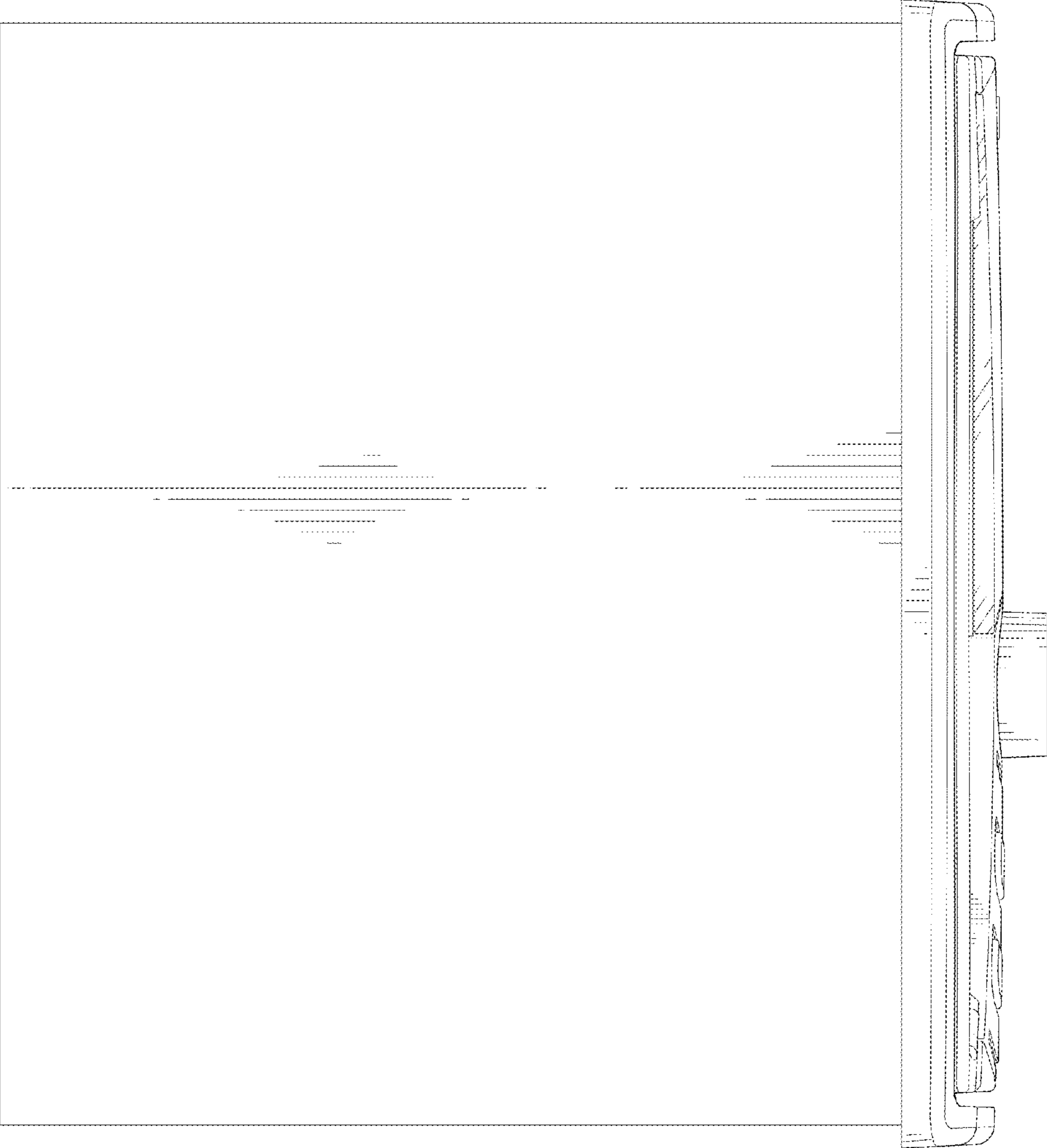

FIG. 3

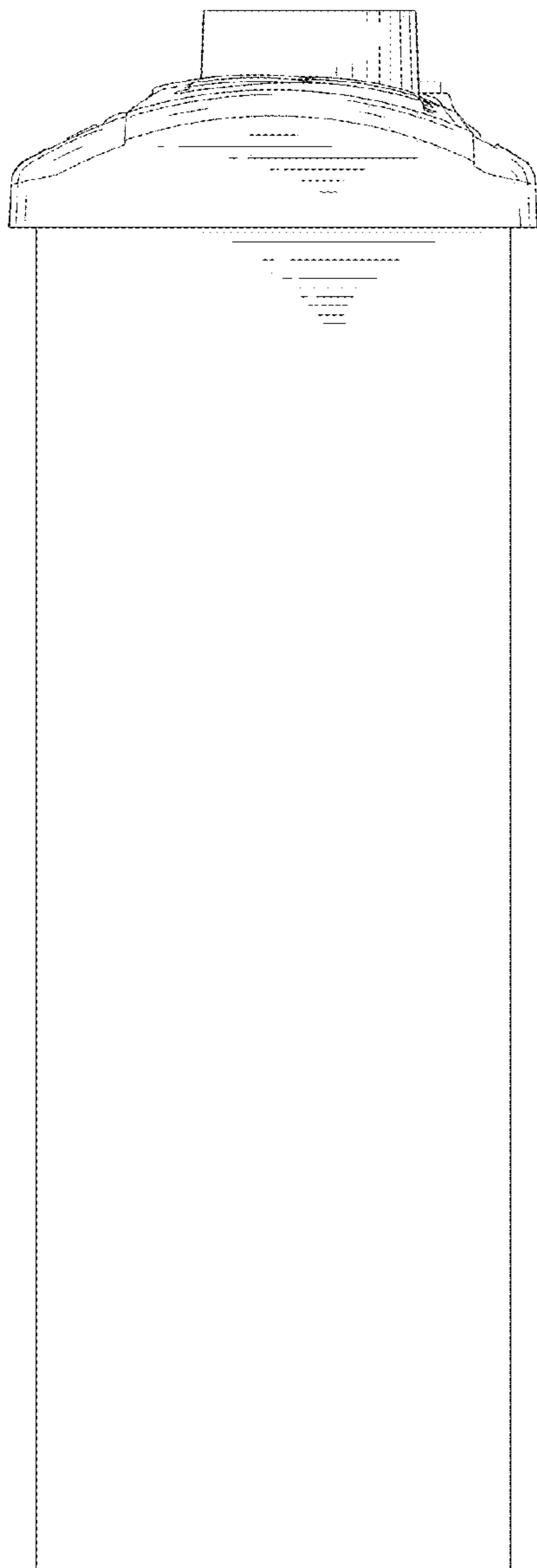

FIG. 4

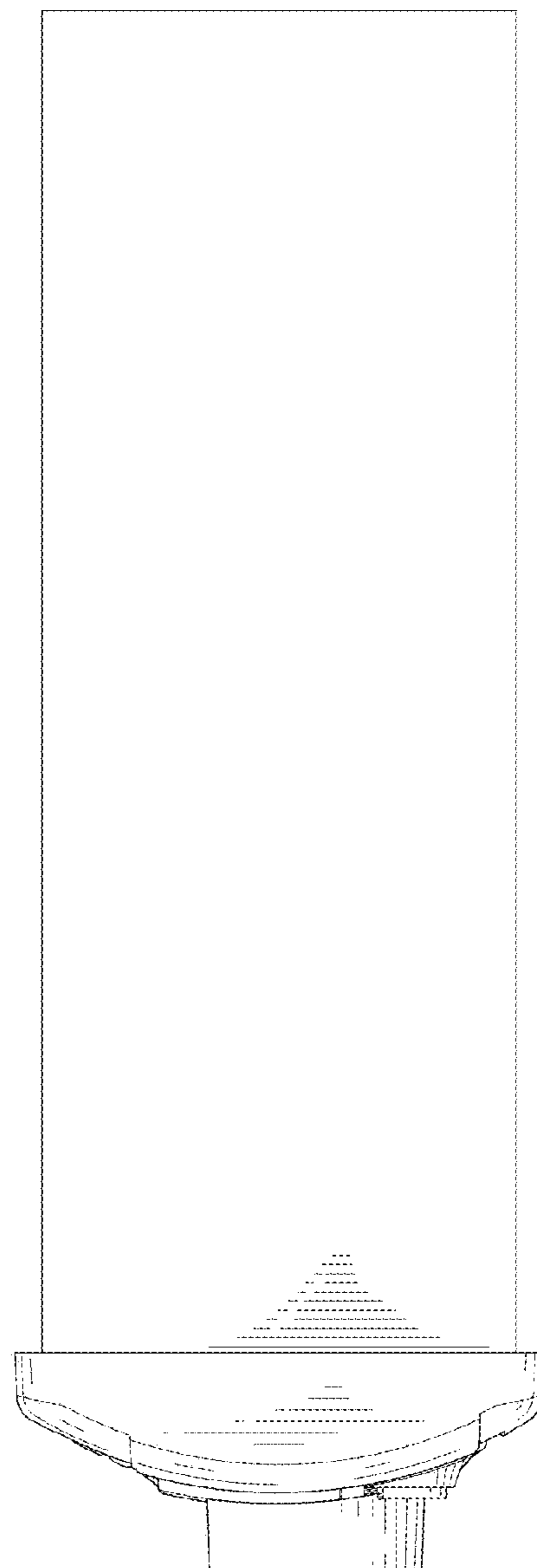

FIG. 5

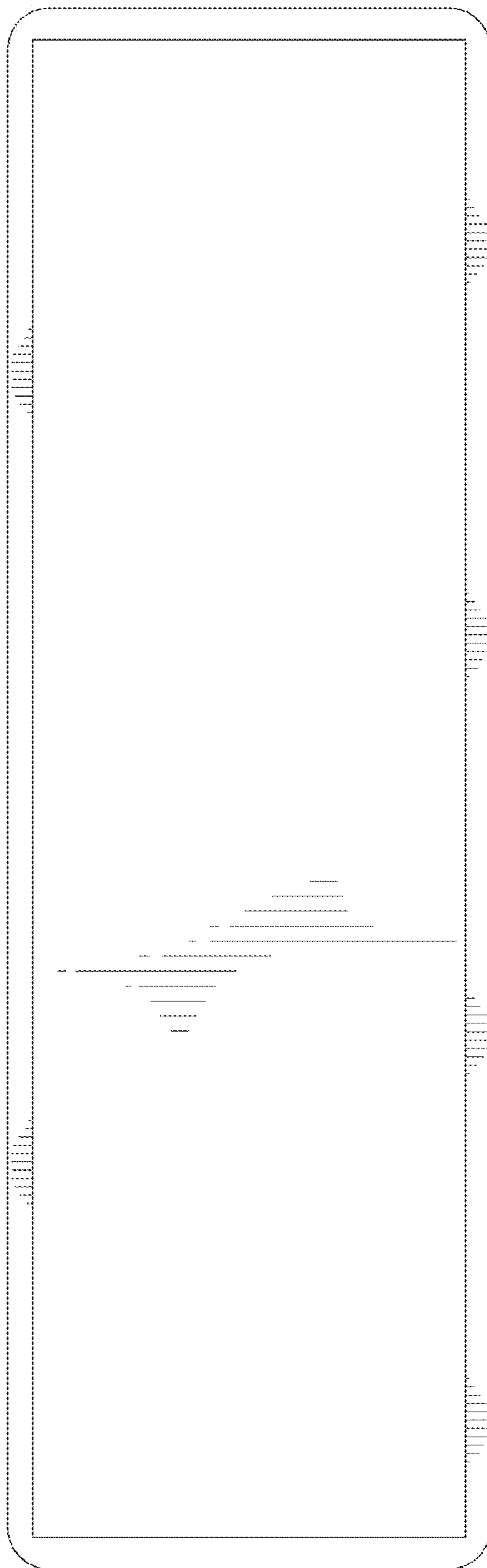

FIG. 6

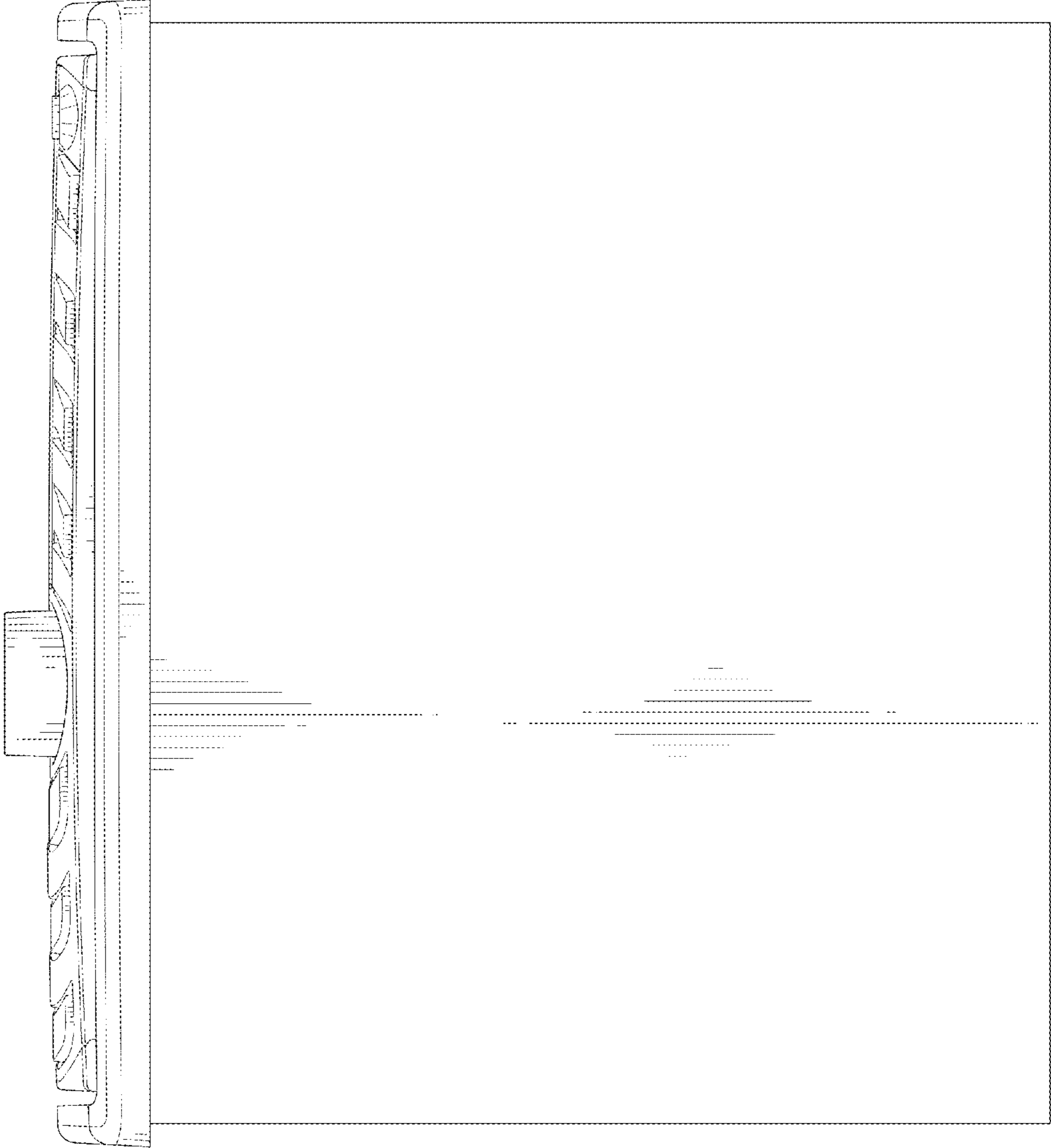

FIG. 7