



US00D675492S

(12) **United States Design Patent**
Art

(10) **Patent No.:** **US D675,492 S**

(45) **Date of Patent:** **** Feb. 5, 2013**

(54) **SELF-WATERING INSERT FOR BUCKET**

(76) Inventor: **James D. Art**, Bradenton, FL (US)

(**) Term: **14 Years**

(21) Appl. No.: **29/412,290**

(22) Filed: **Feb. 1, 2012**

(51) **LOC (9) Cl.** **08-01**

(52) **U.S. Cl.** **D8/1; D32/54**

(58) **Field of Classification Search** **D32/53-54;**
D8/1; 47/48.5, 65.5, 79

See application file for complete search history.

(56) **References Cited**

U.S. PATENT DOCUMENTS

2,058,934	A *	10/1936	Yohe	47/79
3,903,644	A *	9/1975	Swift et al.	47/79
5,459,960	A *	10/1995	Manlove	47/65.5
6,138,411	A *	10/2000	Lin	47/79
6,584,730	B1 *	7/2003	Mai	47/79
7,024,818	B2 *	4/2006	Maniscalco et al.	47/65.6
D559,051	S *	1/2008	Fleece	D8/1
D590,219	S *	4/2009	Jabs	D8/1
8,065,834	B2 *	11/2011	Eckert	47/66.1

* cited by examiner

Primary Examiner — Robin V Webster

(74) *Attorney, Agent, or Firm* — Dorothy S. Morse

(57) **CLAIM**

The ornamental design for a self-watering bucket insert for bucket, as shown and described.

DESCRIPTION

FIG. 1 is a perspective view from the top of a self-watering bucket insert, according to my new design, with broken lines forming no part thereof;

FIG. 2 is a perspective view from the top of the perforated plate portion of my design;

FIG. 3 is a perspective view from the top of the stanchion portion of my design;

FIG. 4 is top view of the self-watering bucket insert;

FIG. 5 is a bottom view of the self-watering bucket insert;

FIG. 6 is a side view of the self-watering bucket insert;

FIG. 7 is top view of the perforated plate portion;

FIG. 8 is a bottom view of the perforated plate portion;

FIG. 9 is a side view of the perforated plate portion;

FIG. 10 is top view of the stanchion portion;

FIG. 11 is a bottom view of the stanchion portion;

FIG. 12 is a side view of the stanchion portion;

FIG. 13 is a perspective view from the top of the self-watering bucket insert, with the oval area defined by broken lines including the connection between the perforated plate portion and the stanchion portion of my design; and,

FIG. 14 is an enlarged view of the oval area identified by broken lines in FIG. 13.

1 Claim, 4 Drawing Sheets

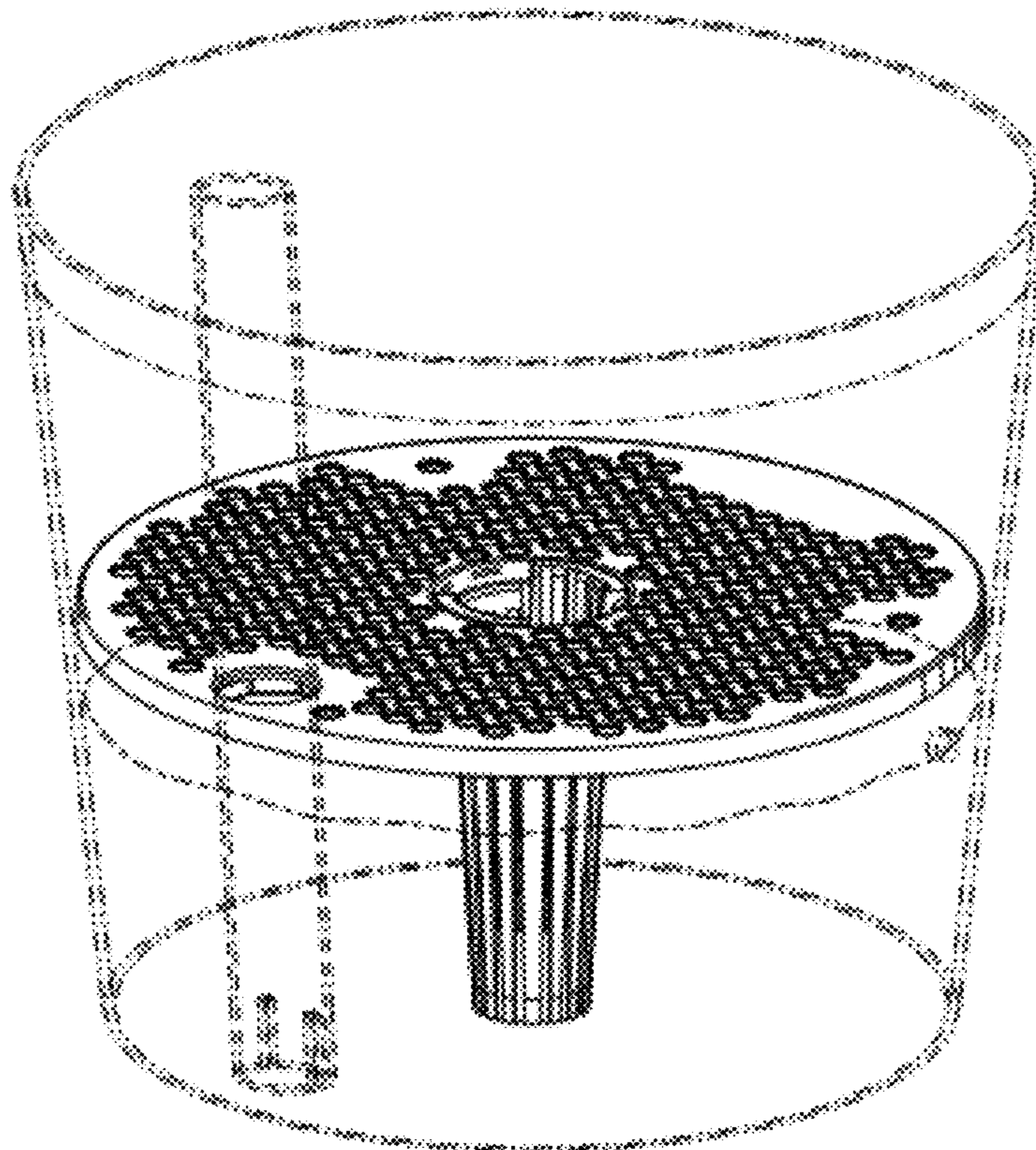

FIG 1

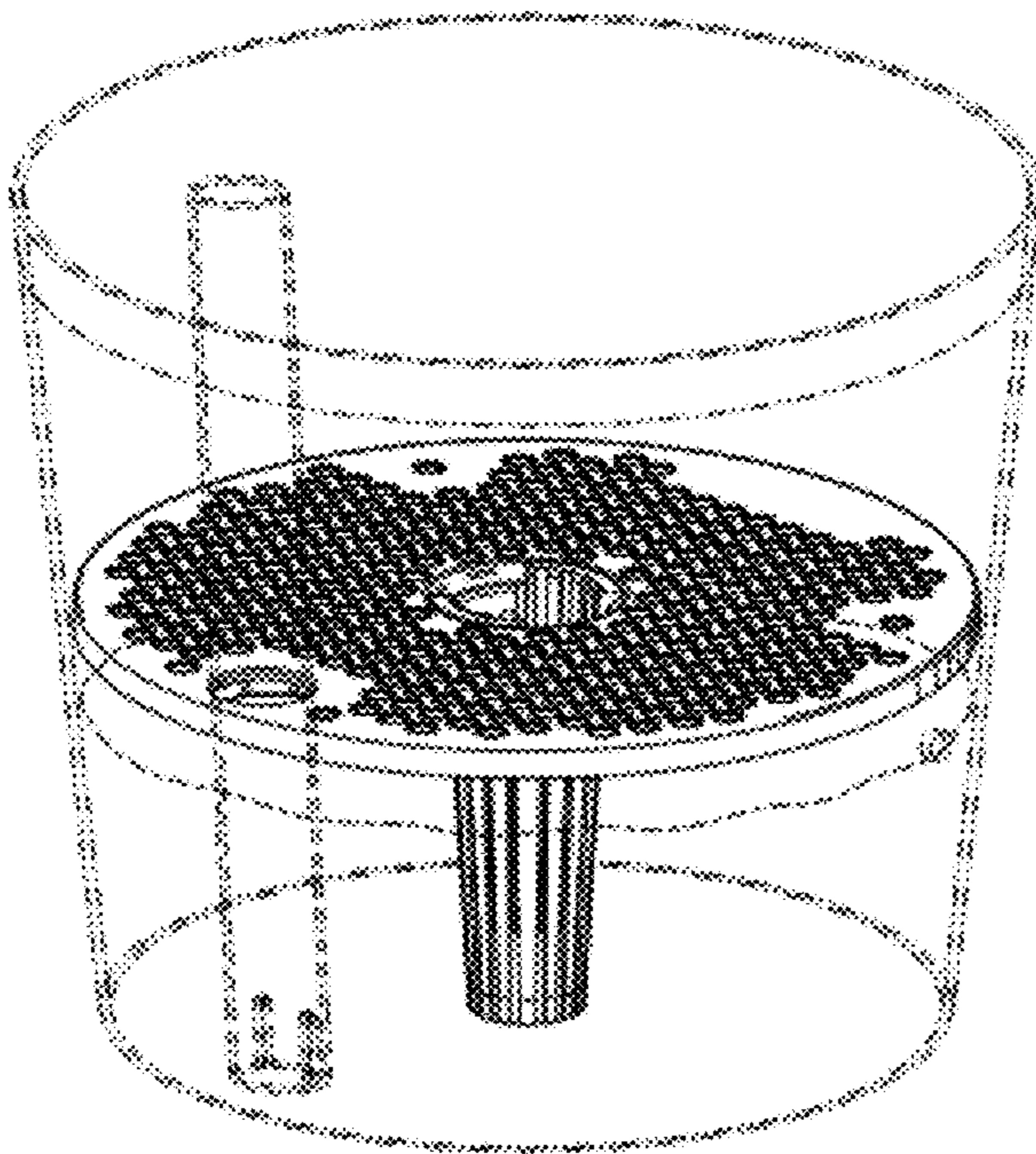

FIG 2

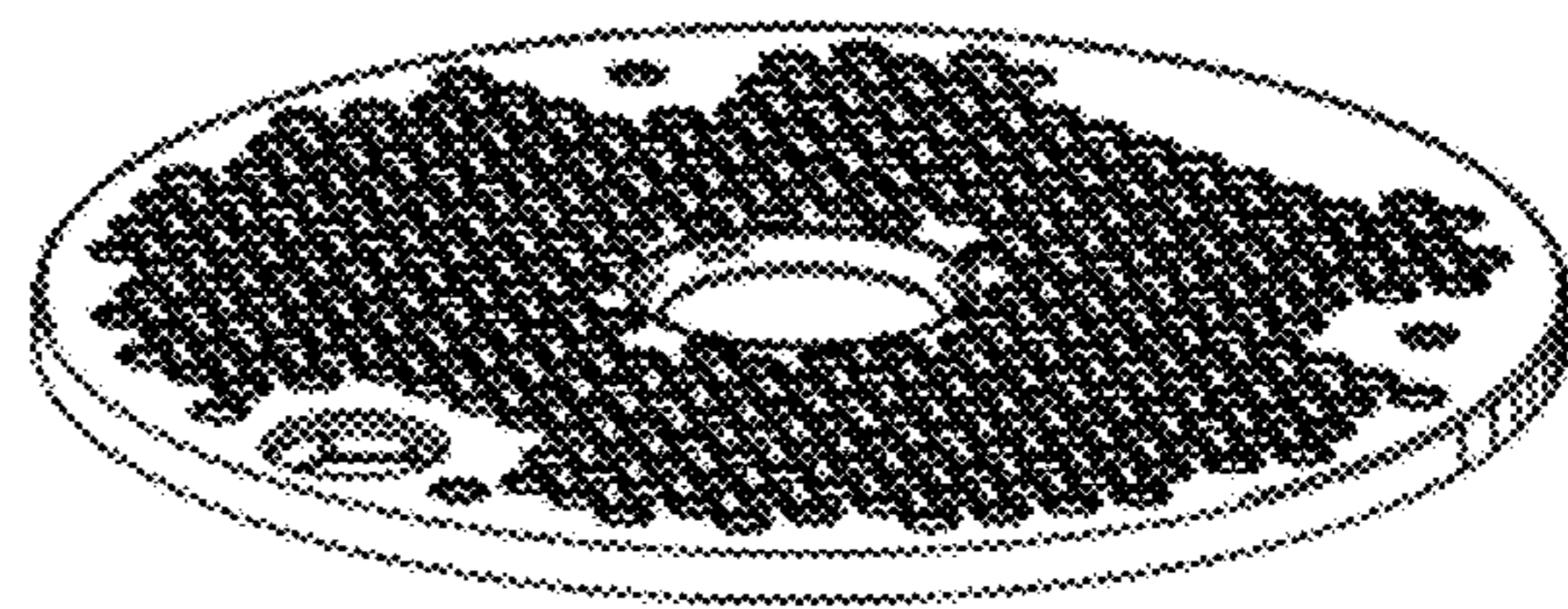

FIG 3

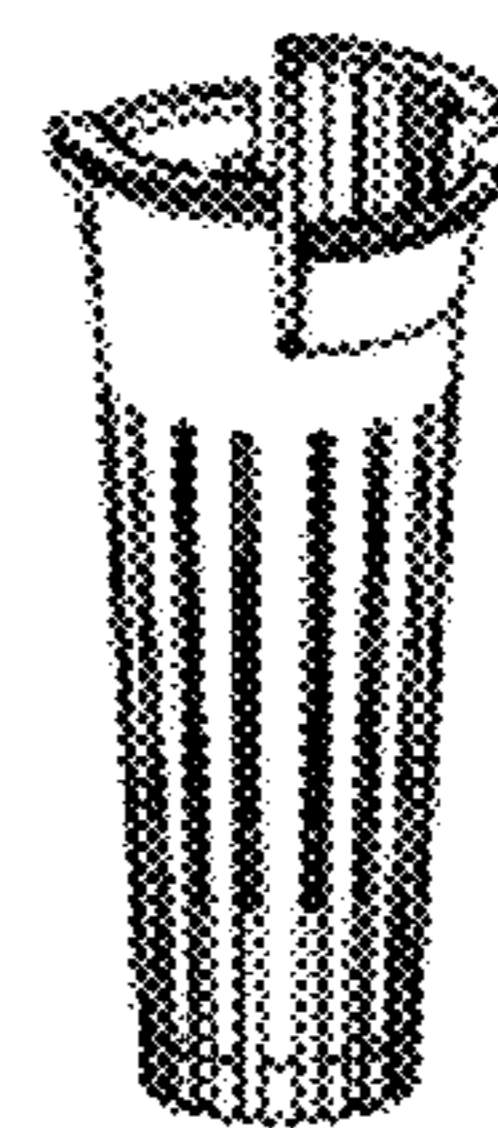

FIG 4

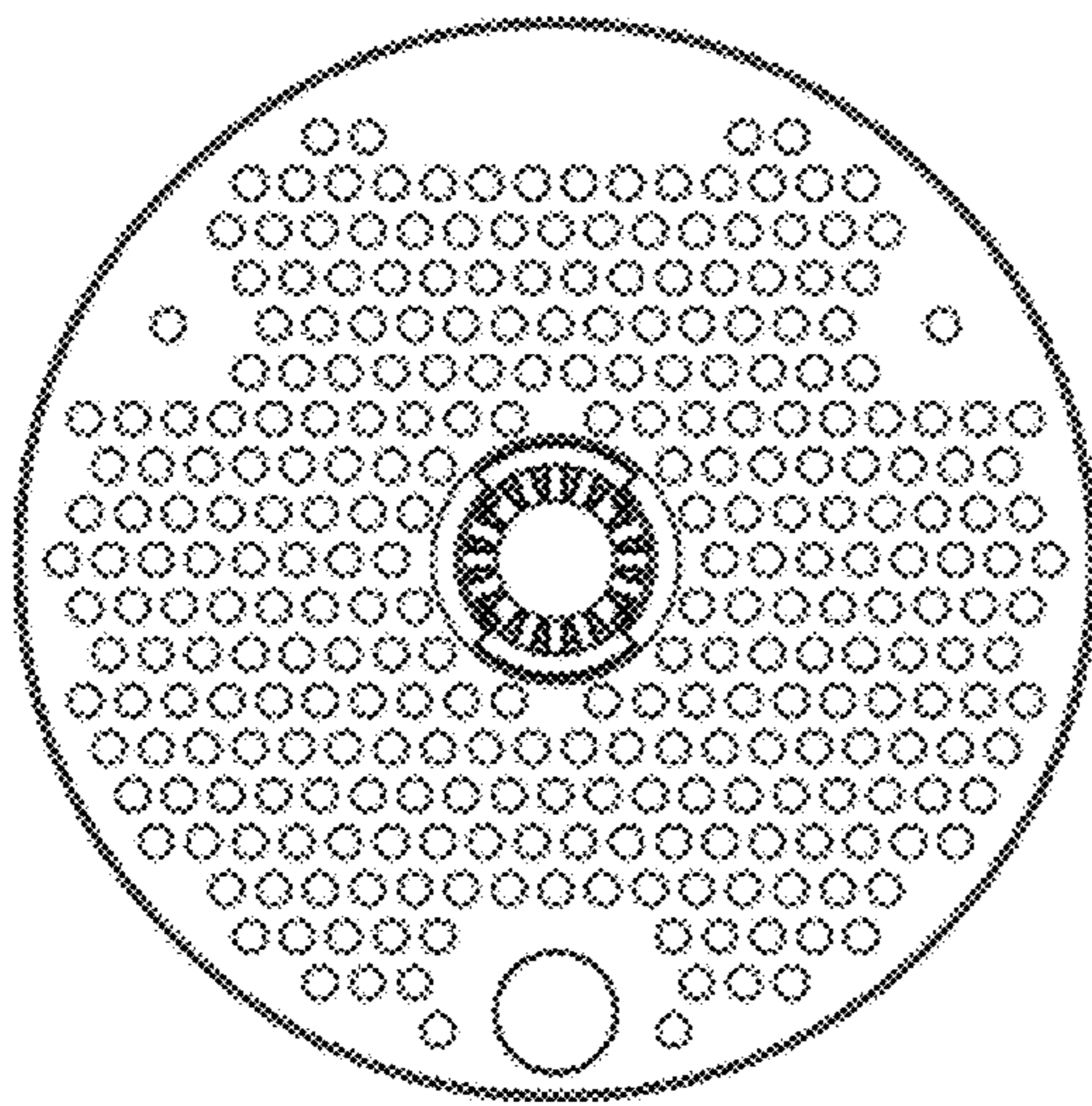

FIG 5

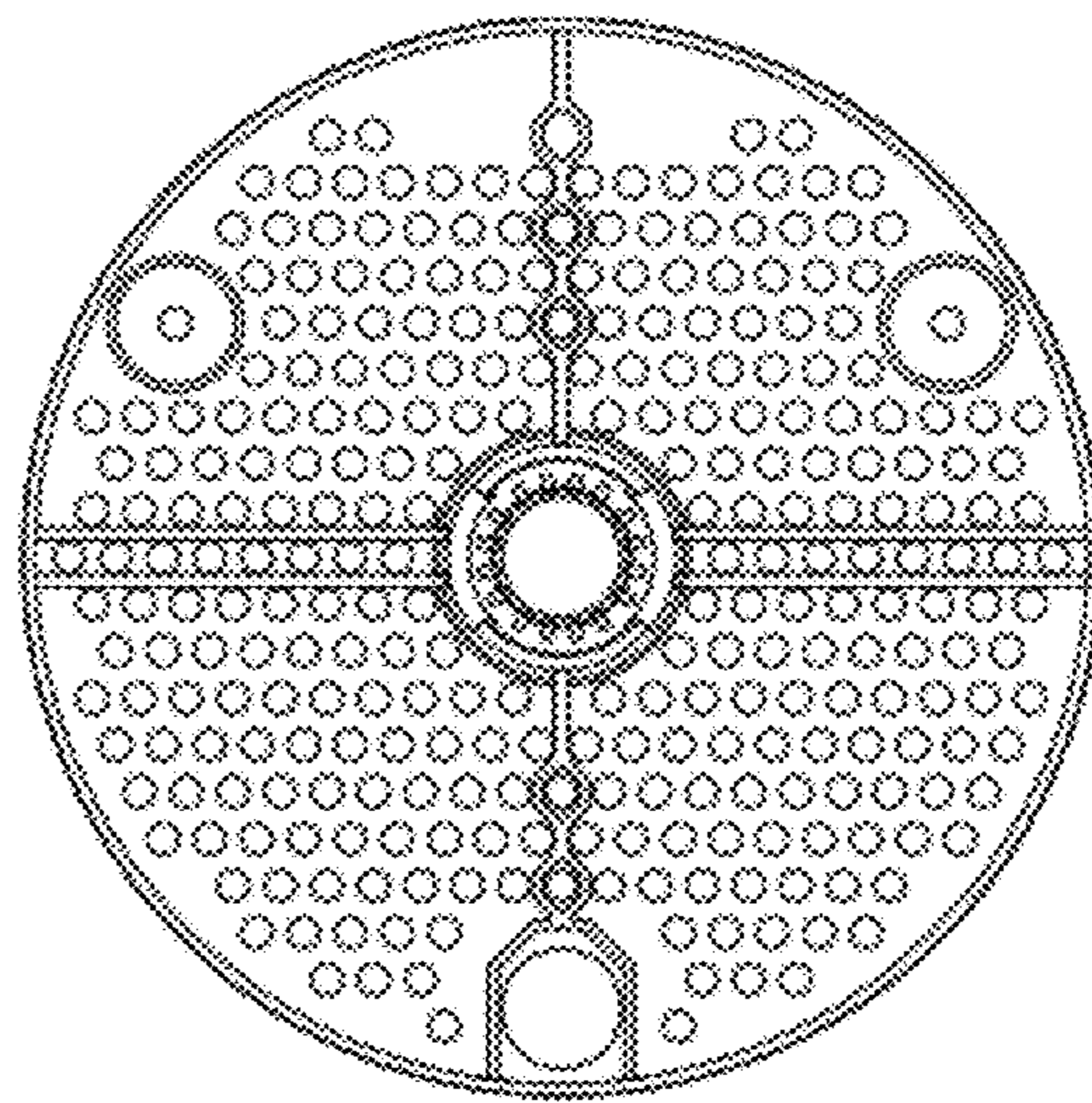

FIG 6

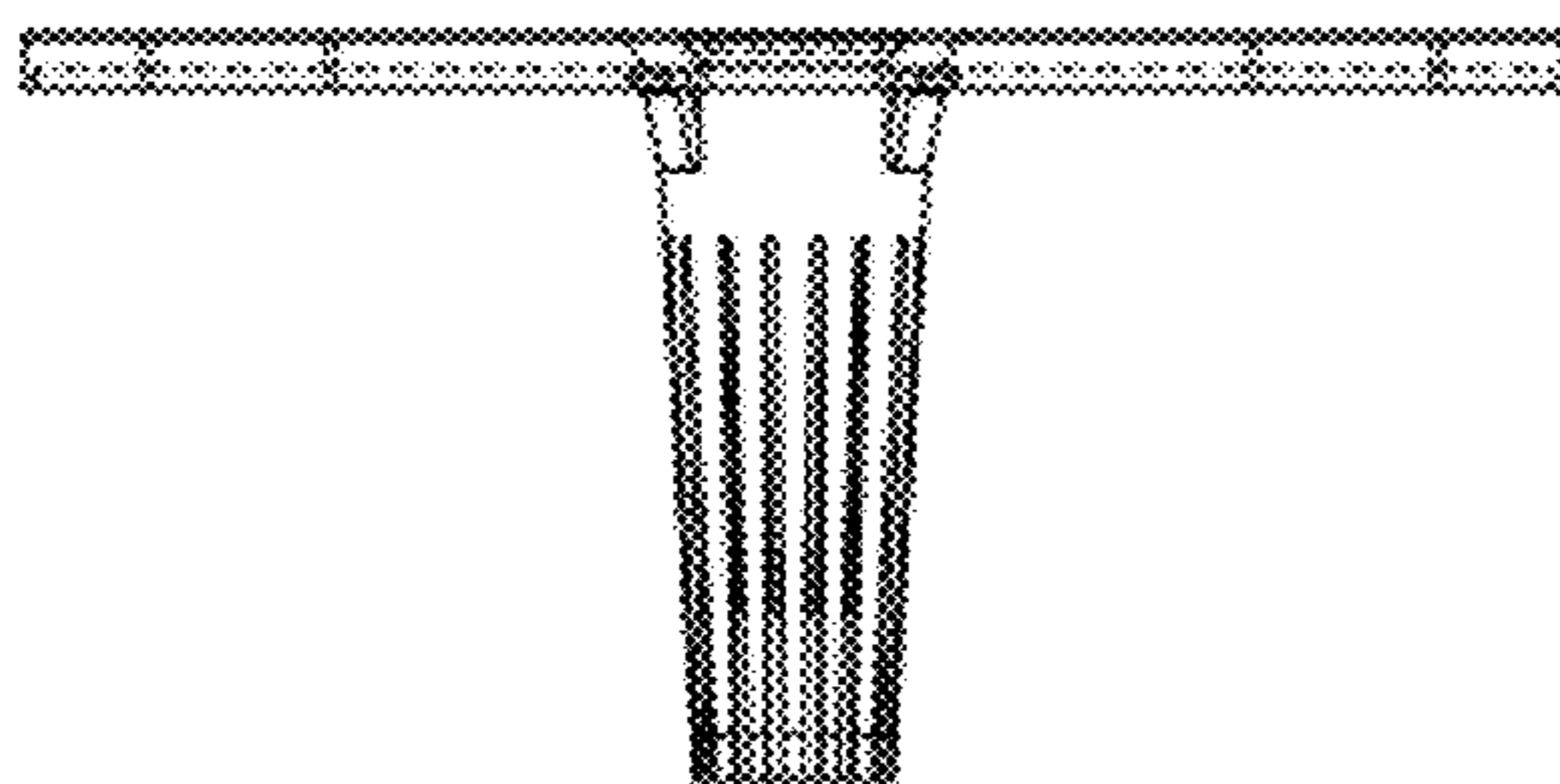

FIG 7

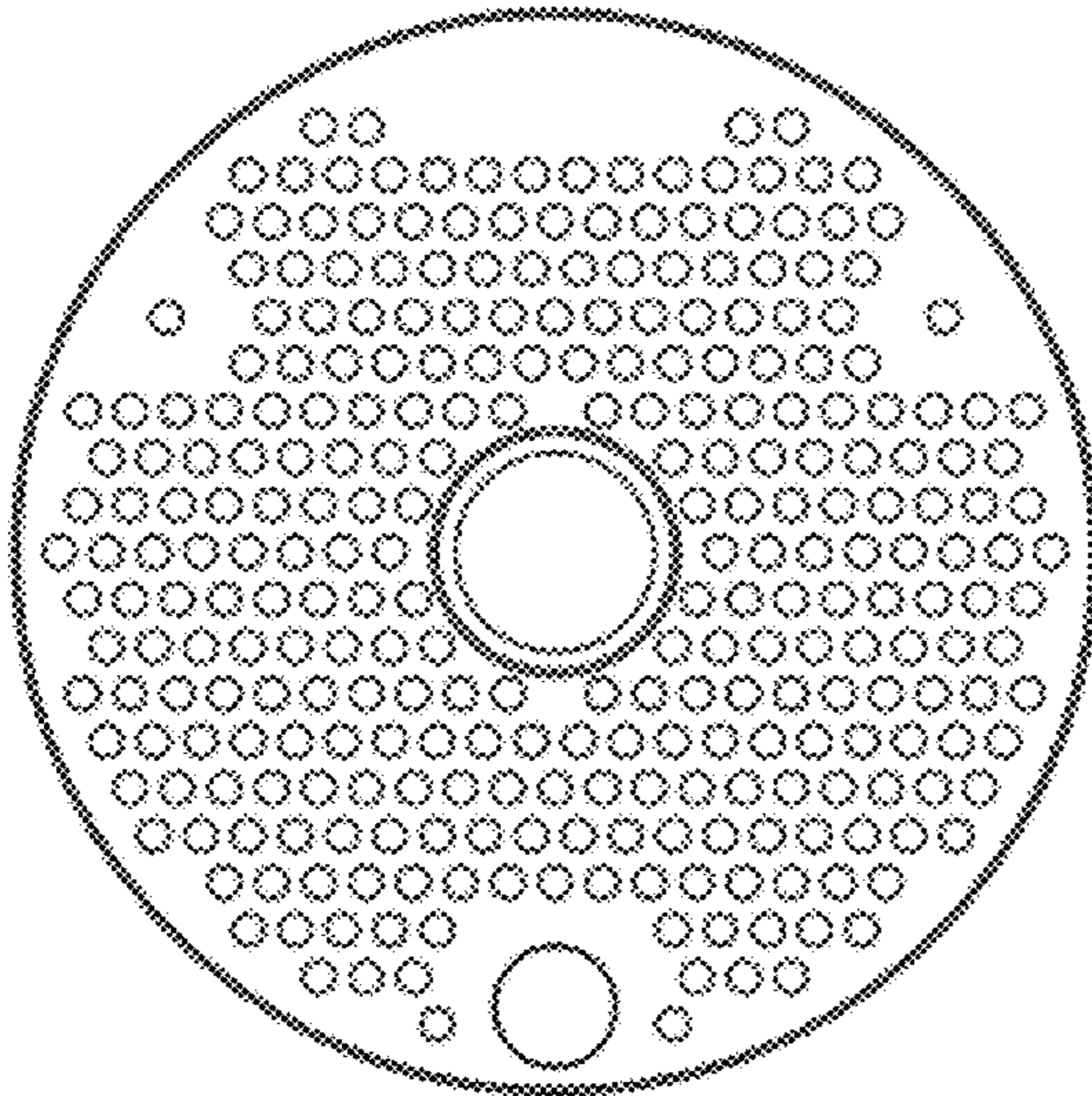

FIG 8

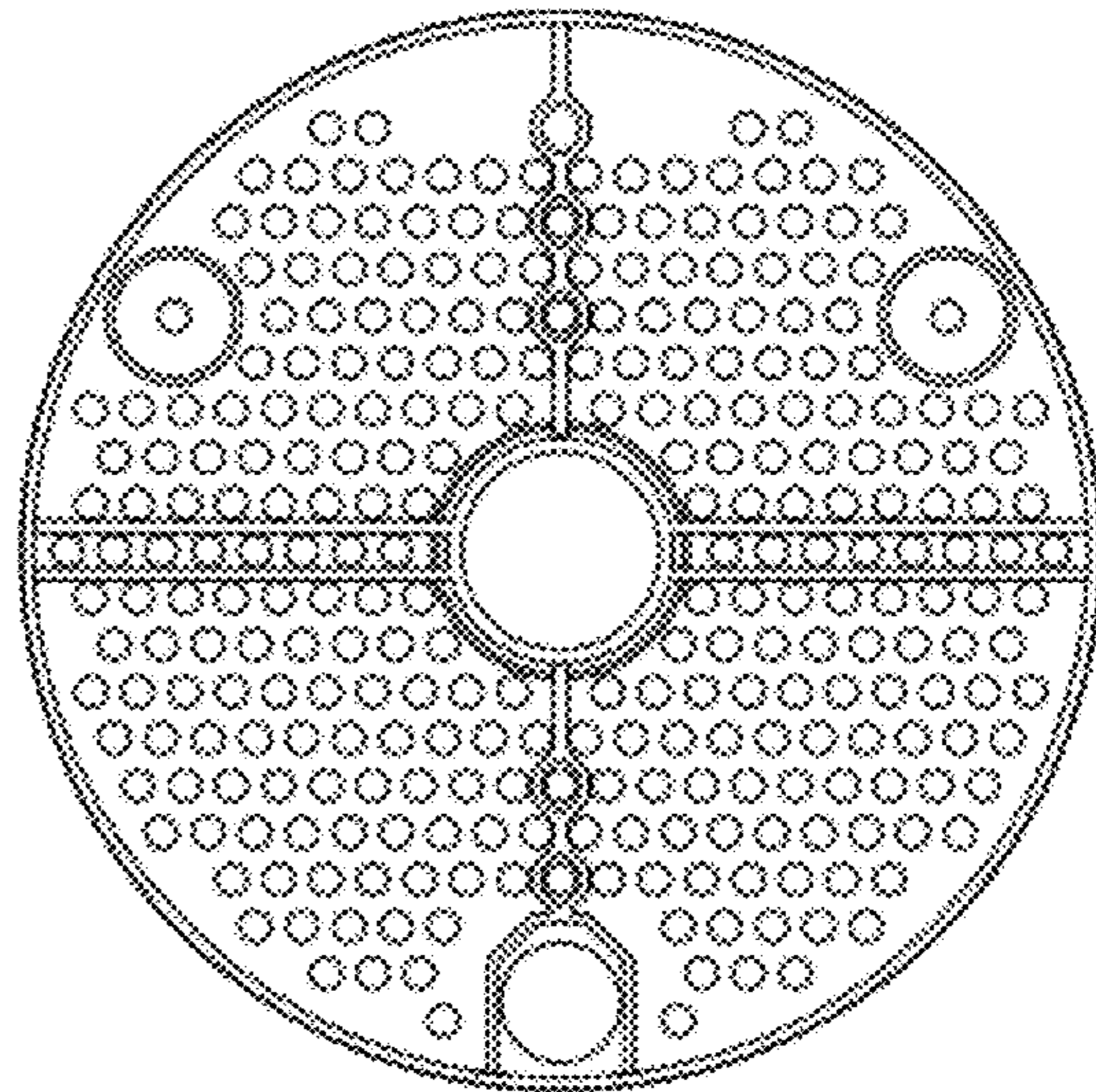

FIG 9

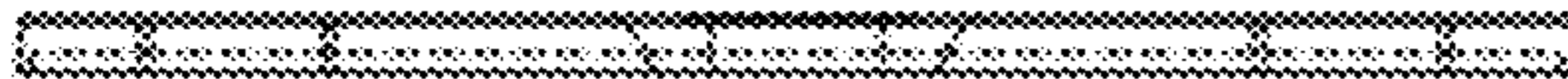

FIG 10

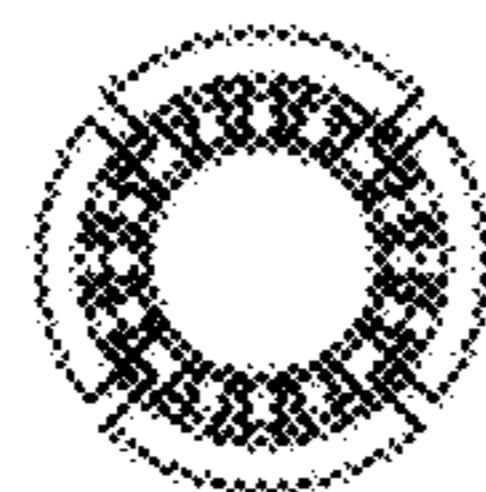

FIG 11

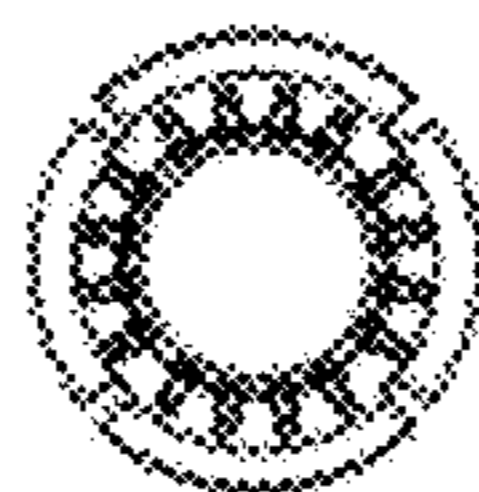

FIG 12

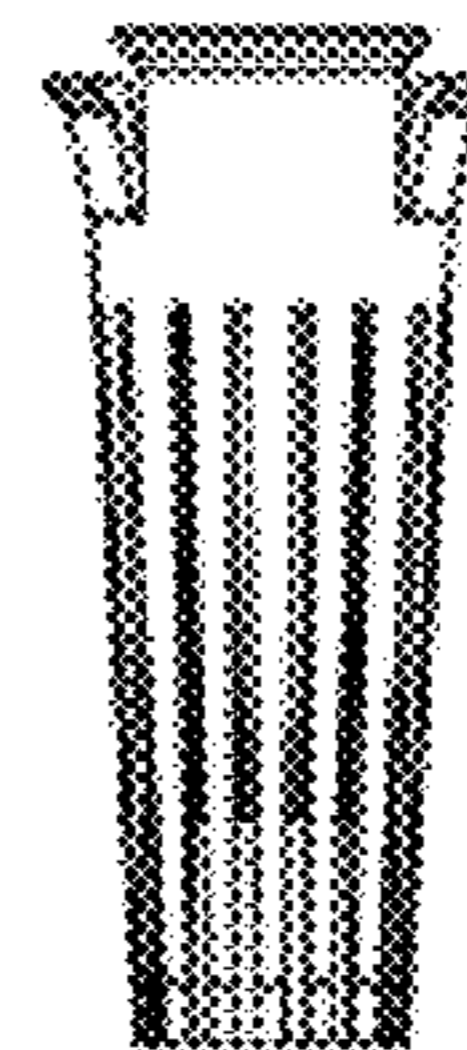

FIG 13

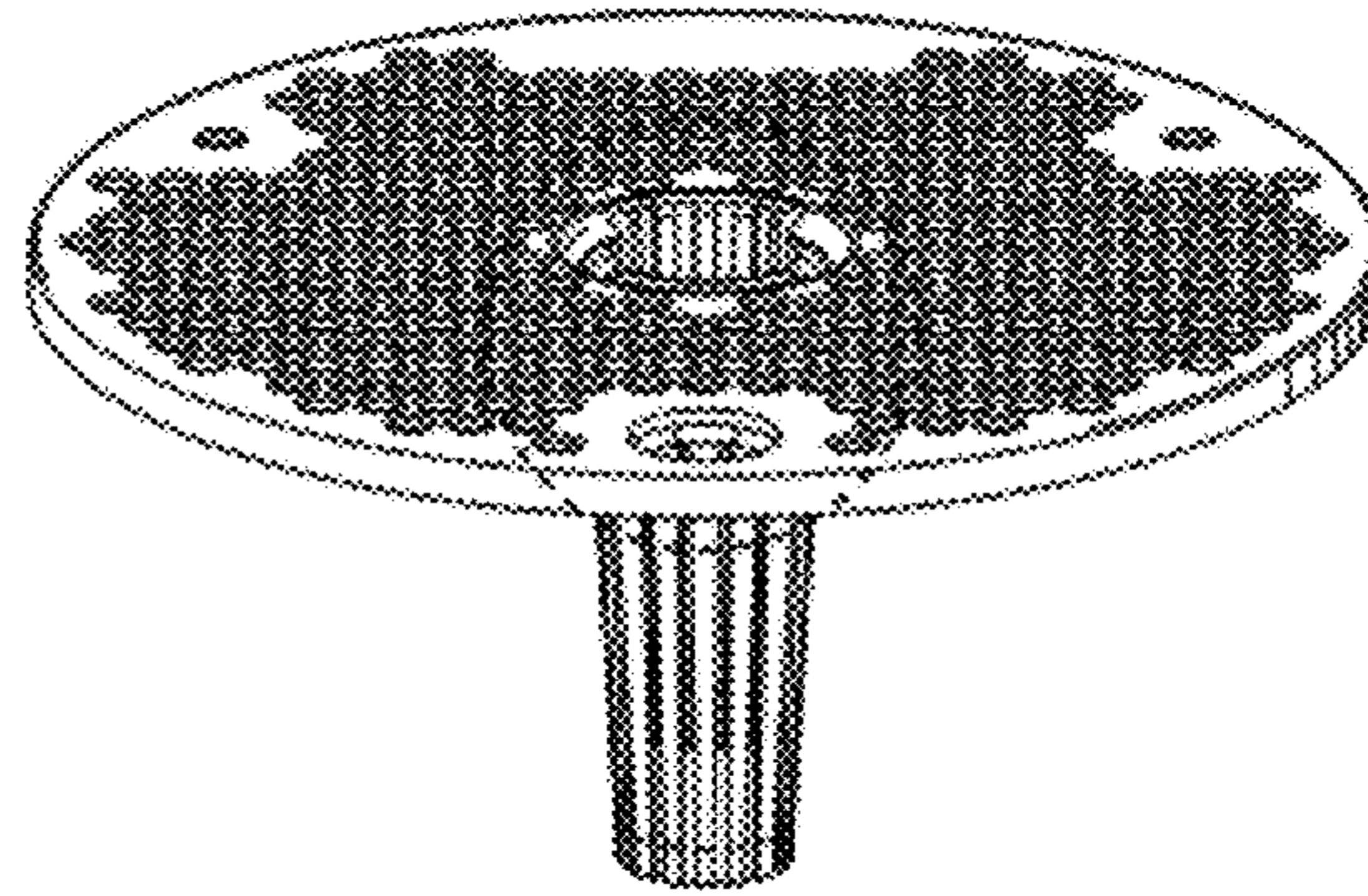

FIG 14

