



US00D675433S

(12) **United States Design Patent**
Buie, II

(10) **Patent No.:** **US D675,433 S**
(45) **Date of Patent:** **** Feb. 5, 2013**

- (54) **ENCLOSURE FOR A GUN CLEANING KIT**
- (75) **Inventor:** **James H. Buie, II**, Little Rock, AR (US)
- (73) **Assignee:** **DAC Technologies Group Int'l., Inc.**,
Little Rock, AR (US)
- (**) **Term:** **14 Years**
- (21) **Appl. No.:** **29/374,769**
- (22) **Filed:** **Oct. 4, 2011**
- (51) **LOC (9) Cl.** **03-01**
- (52) **U.S. Cl.** **D3/262**
- (58) **Field of Classification Search** D3/271.1,
D3/262; 206/579, 525
See application file for complete search history.

D407,212	S	3/1999	Molaro	
5,972,125	A	10/1999	Hedge	
6,126,005	A	10/2000	Long, Jr.	
6,209,723	B1	4/2001	Fields	
6,244,899	B1	6/2001	Bogursky	
6,269,579	B1	8/2001	Warner	
D457,697	S	5/2002	Savage	
D480,207	S	10/2003	Marks	
D480,522	S	10/2003	Sasaki	
6,640,480	B2	11/2003	Williams	
6,701,657	B1	3/2004	Hudspeth	
D499,552	S	12/2004	Nissanoff	
D500,952	S	1/2005	Moore	
7,020,994	B2	4/2006	Buie, II	
D535,476	S	1/2007	Pennington	
7,163,673	B2	1/2007	Compton et al.	
7,356,961	B2	4/2008	Williams	
7,367,151	B1	5/2008	Black	
D602,663	S	10/2009	Pennington	
7,841,472	B1	11/2010	Williams	
D648,537	S *	11/2011	Kostner D3/315
2003/0136044	A1	7/2003	Williams	
2006/0010753	A1	1/2006	Buie	
2008/0295818	A1	12/2008	Styles	
2009/0145785	A1	6/2009	Garrett	
2009/0193703	A1	8/2009	Riley	
2010/0175296	A1	7/2010	Williams	
2011/0047853	A1	3/2011	Williams	

(56) **References Cited**

U.S. PATENT DOCUMENTS

2,780,399	A *	2/1957	Long	223/107
3,752,306	A *	8/1973	Thompson et al.	206/525
3,813,802	A	6/1974	Di Prospero		
D268,987	S	5/1983	Smith		
4,399,627	A	8/1983	Malesky		
4,716,673	A	1/1988	Williams		
4,807,381	A	2/1989	Southard		
4,873,777	A	10/1989	Southard		
4,899,415	A	2/1990	Wheeler		
4,901,464	A	2/1990	Banoun		
D310,302	S	9/1990	Southard		
D313,886	S	1/1991	Southard		
5,052,555	A	10/1991	Harmon		
5,075,998	A	12/1991	Selleck		
5,202,523	A	4/1993	Grossman		
D339,470	S	9/1993	Marks		
5,317,827	A	6/1994	Jaremco		
5,379,542	A	1/1995	Guzman		
5,427,239	A	6/1995	Hunt		
D373,297	S	9/1996	Hill		
D376,474	S	12/1996	Marks		
5,588,242	A	12/1996	Hughes		
5,645,091	A	7/1997	Hoefl		
D381,897	S	8/1997	Matthiesen		
5,755,055	A	5/1998	Thompson		
5,775,020	A	7/1998	Baird		
5,775,021	A	7/1998	Weiss		

* cited by examiner

Primary Examiner — Holly Baynham
(74) *Attorney, Agent, or Firm* — Stephen D. Carver

(57) **CLAIM**

The ornamental design for an enclosure for a gun cleaning kit, as shown and described.

DESCRIPTION

FIG. 1 is a frontal isometric view of the preferred embodiment of my new enclosure for a gun cleaning kit; FIG. 2 is a rear isometric view thereof; FIG. 3 is a front plan view thereof; FIG. 4 is a rear plan view thereof; FIG. 5 is a left side elevational view thereof; FIG. 6 is a right side elevational view thereof; FIG. 7 is a top plan view thereof; and, FIG. 8 is a bottom plan view thereof.

1 Claim, 5 Drawing Sheets

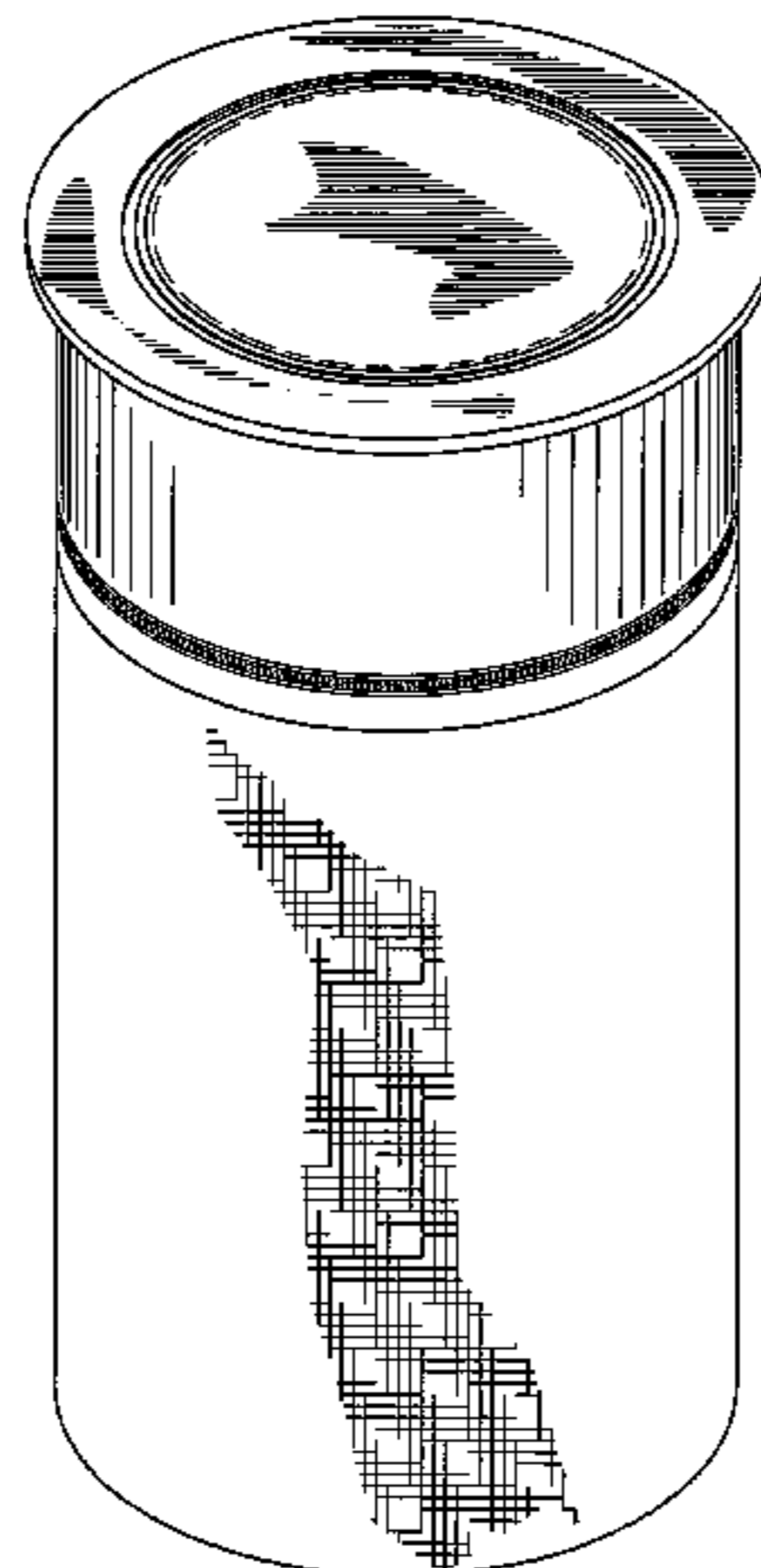

FIG. 1

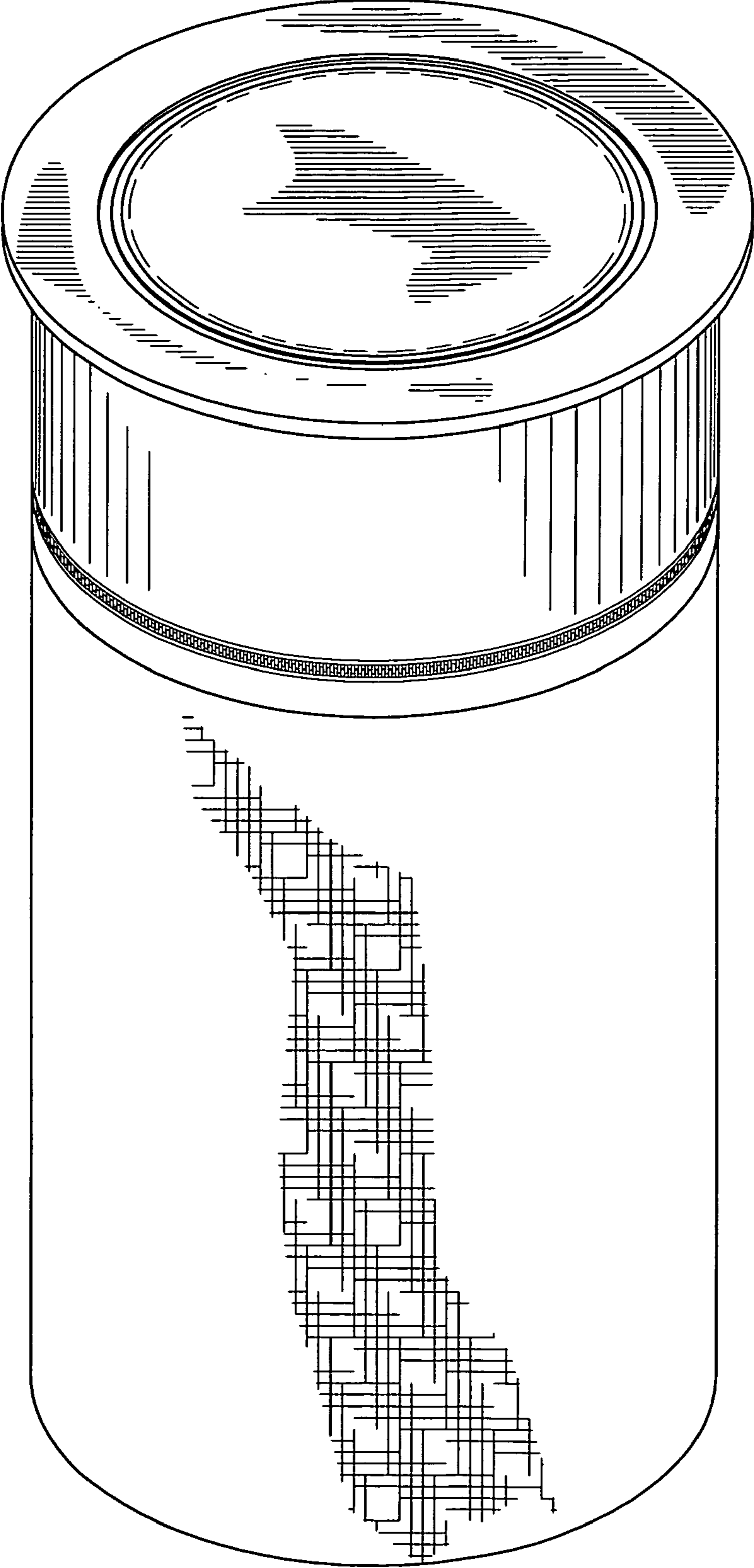

FIG. 2

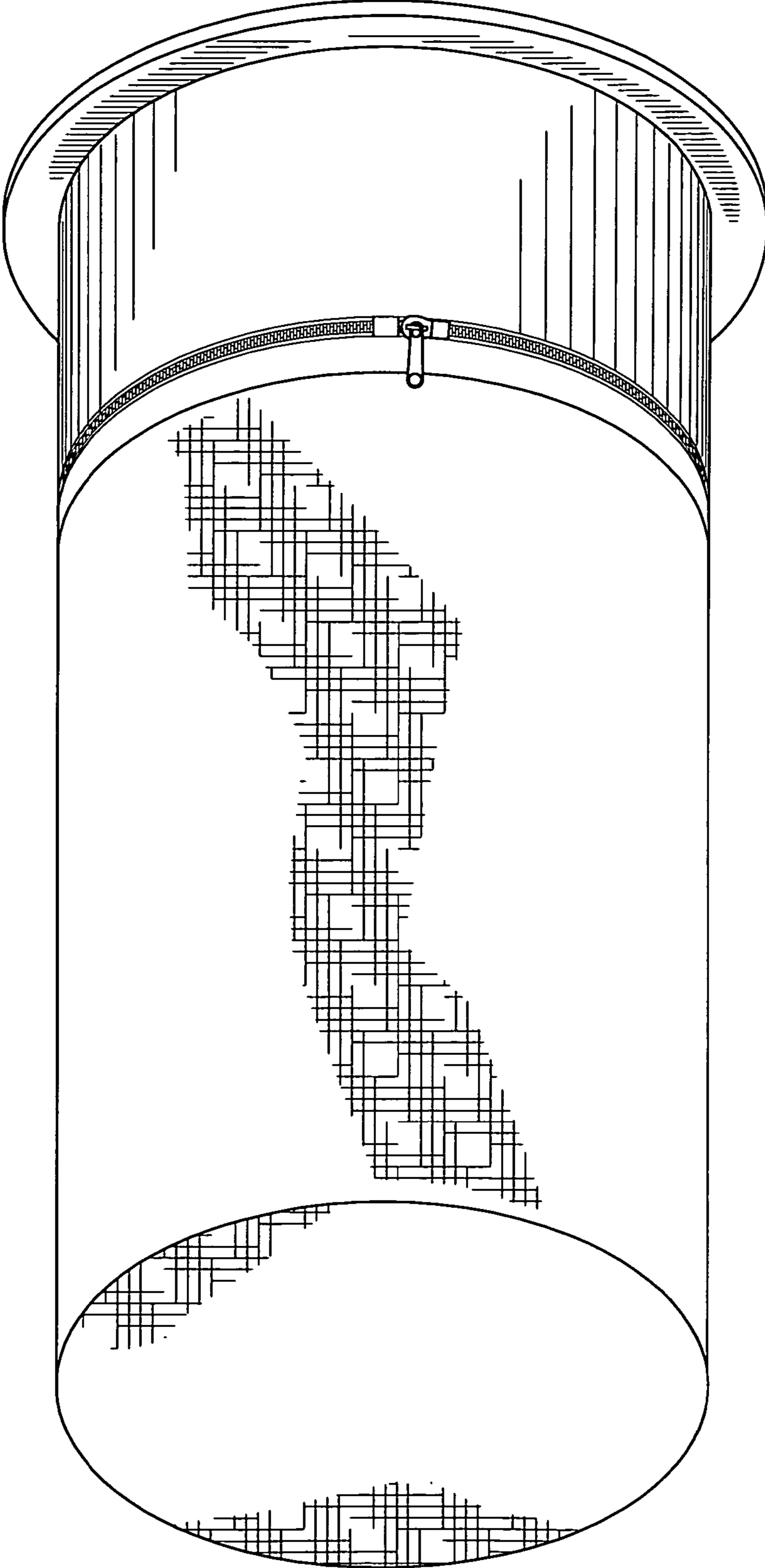

FIG. 3

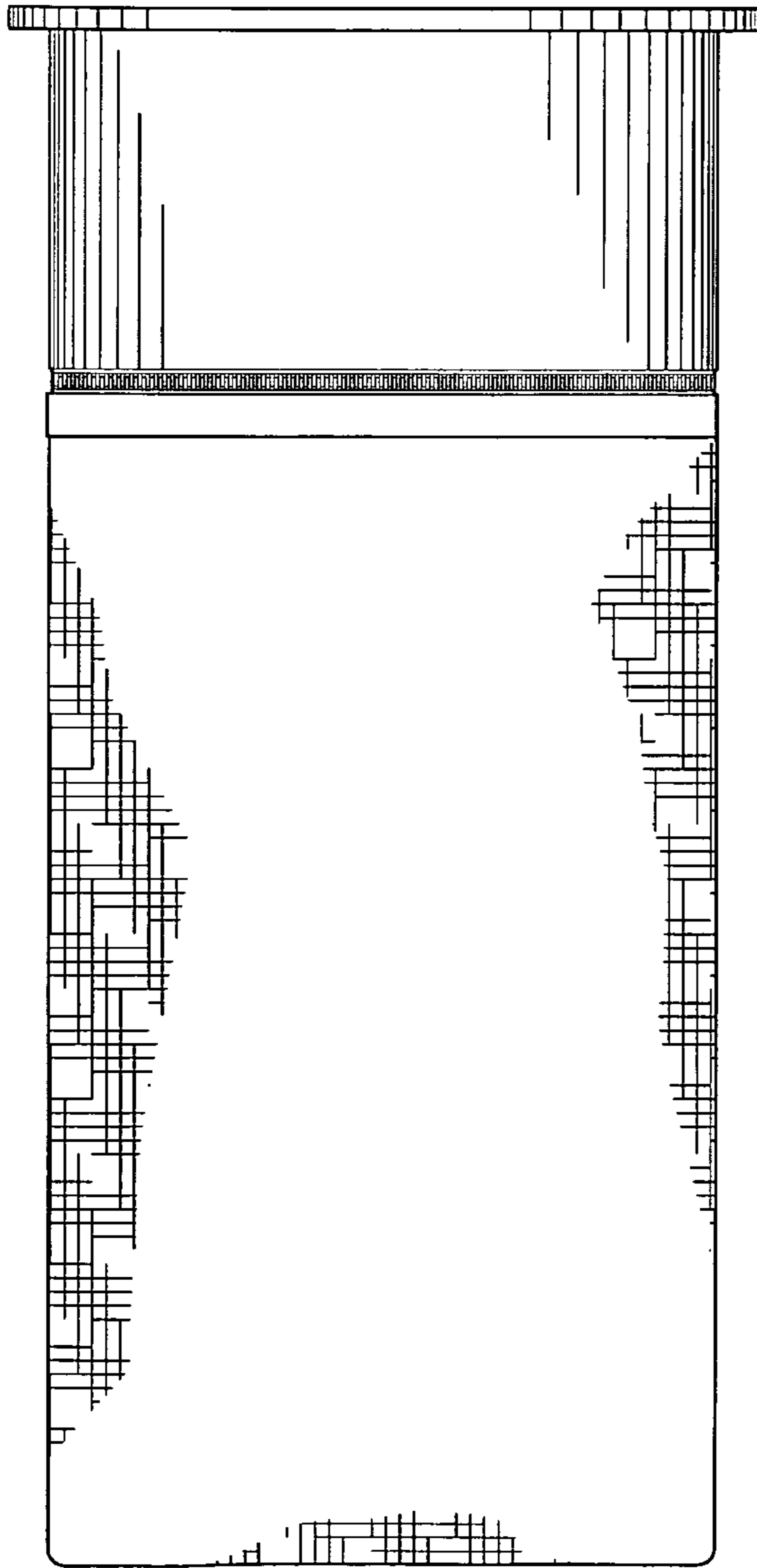

FIG. 4

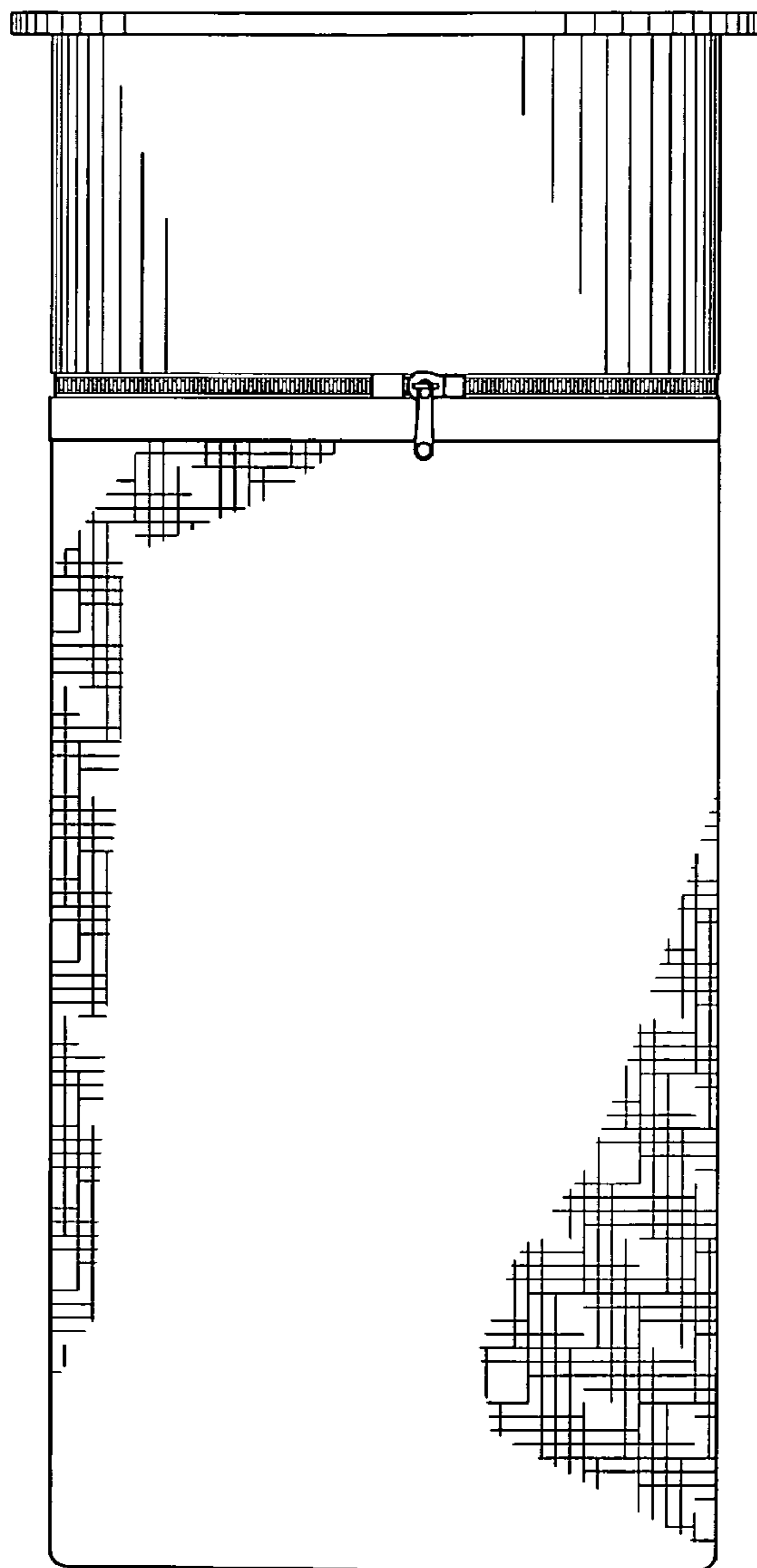

FIG. 5

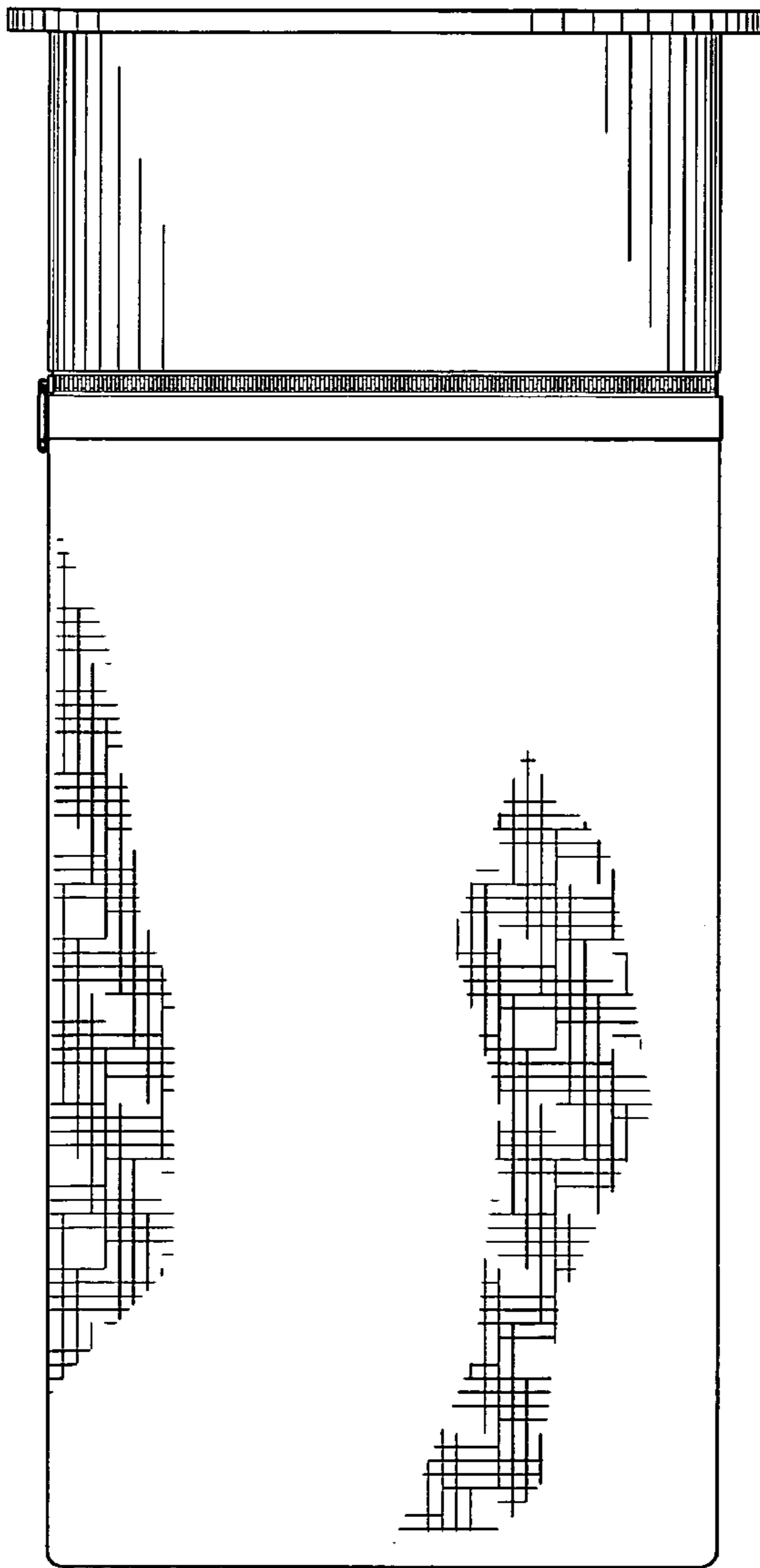

FIG. 6

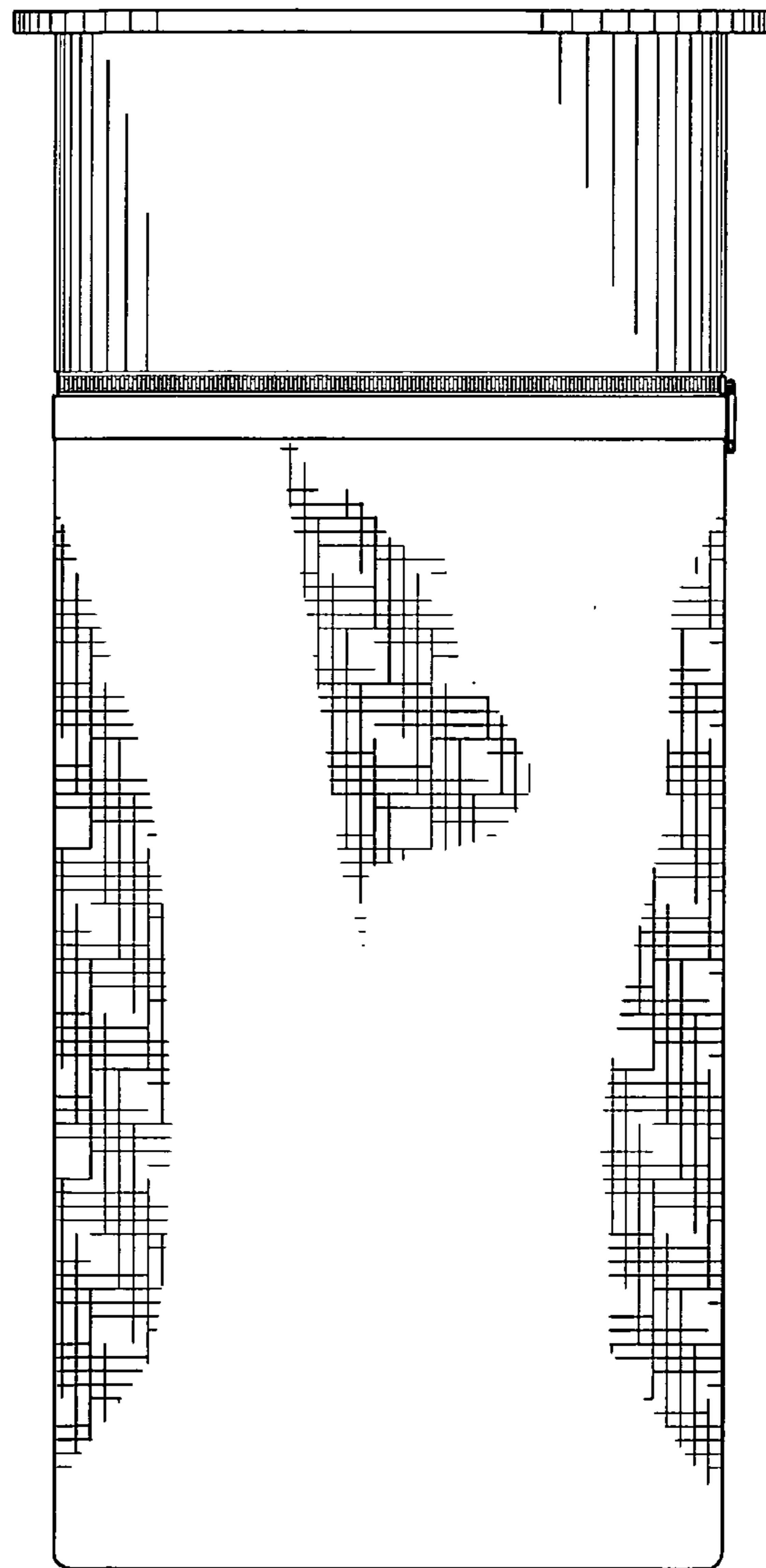

FIG. 7

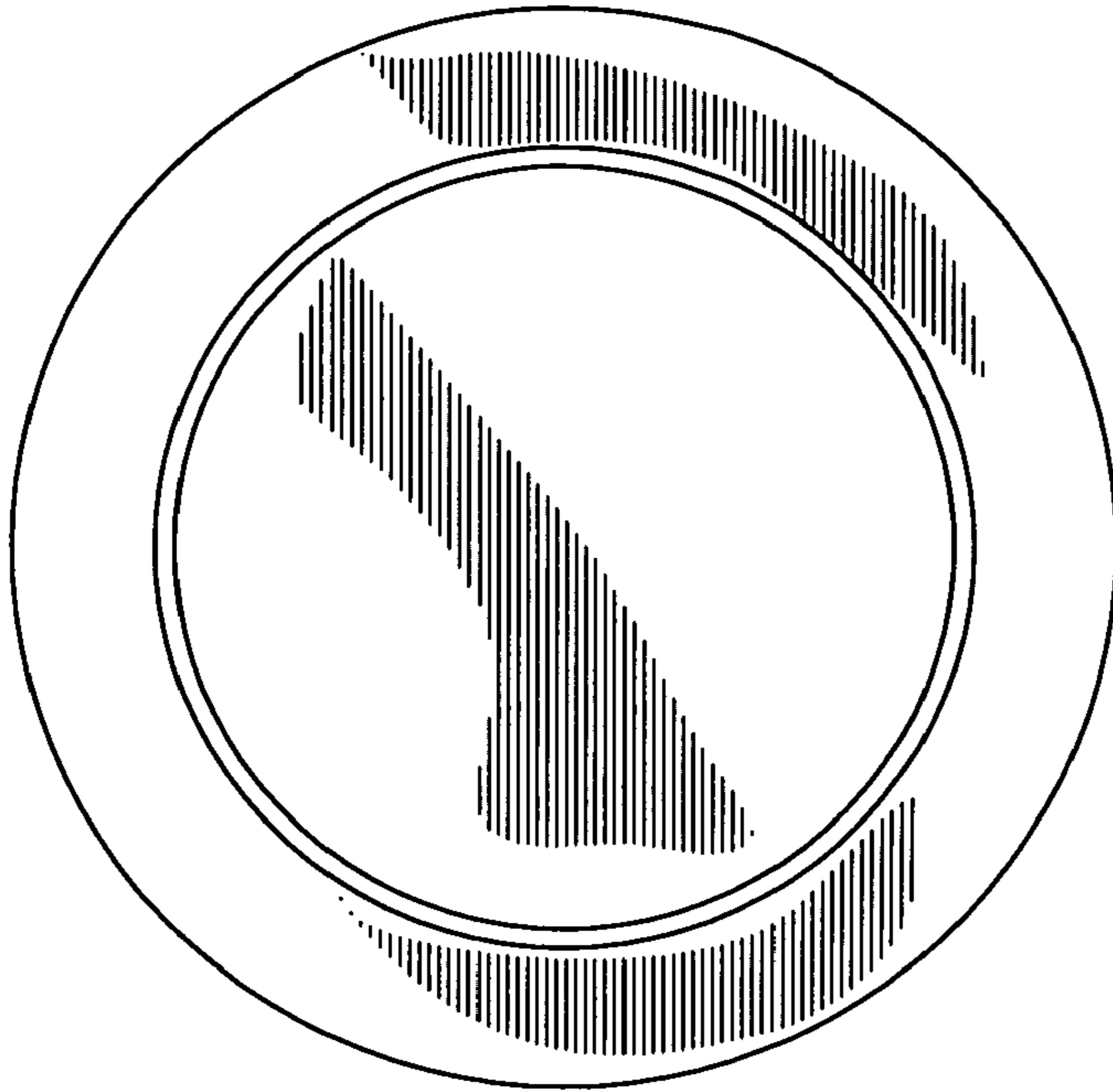

FIG. 8

