



US00D675417S

(12) **United States Design Patent**
Cheifetz

(10) **Patent No.:** **US D675,417 S**

(45) **Date of Patent:** **** Feb. 5, 2013**

(54) **SHOE HEEL**

(76) Inventor: **Arielle Raitt Cheifetz**, Buffalo Grove,
IL (US)

(**) Term: **14 Years**

(21) Appl. No.: **29/381,742**

(22) Filed: **Dec. 22, 2010**

(51) **LOC (9) Cl.** **02-04**

(52) **U.S. Cl.** **D2/965**

(58) **Field of Classification Search** D2/896,
D2/897, 898, 915, 918, 922, 925, 926, 927,
D2/928, 929-933, 939, 940, 964, 965, 966,
D2/967, 968, 972, 976; 36/83, 92, 11.5,
36/34 R, 35 R, 36 R, 36 A, 36 B, 36 C, 37,
36/38, 35 A, 35 B, 39, 40, 41, 42, 34 A, 34 B,
36/69, 72 B

See application file for complete search history.

(56) **References Cited**

U.S. PATENT DOCUMENTS

267,167	A *	11/1882	Dranly	36/40
D112,968	S *	1/1939	Squire	D2/965
2,212,263	A *	8/1940	Convy	36/34 B
2,291,791	A *	8/1942	Casserd	36/8.3
2,328,319	A *	8/1943	Barton	36/34 A
D146,885	S *	6/1947	Tullgren et al.	D2/950
D216,662	S *	3/1970	Babaresi	D2/965
D216,664	S *	3/1970	Barbaresi	D2/965
D262,750	S *	1/1982	Melzi et al.	D2/918
5,996,261	A *	12/1999	Nelson	36/136
D470,650	S *	2/2003	Lin	D2/964
D499,247	S *	12/2004	Wahoske et al.	D2/972
D500,585	S *	1/2005	Wahoske et al.	D2/972
D515,795	S *	2/2006	Baden et al.	D2/965
D522,221	S *	6/2006	Shin	D2/964
7,216,443	B2 *	5/2007	Baden et al.	36/34 R
D577,479	S *	9/2008	Weitzman	D2/926

D582,138	S *	12/2008	Claveria	D2/927
D595,486	S *	7/2009	Van Hulle	D2/925
D657,944	S *	4/2012	Casadei	D2/946

* cited by examiner

Primary Examiner — Elizabeth J Oswecki

(74) *Attorney, Agent, or Firm* — David Lesht; Milly Park

(57) **CLAIM**

The ornamental design for a shoe heel, as shown and described.

DESCRIPTION

FIG. 1 is a perspective view of a first embodiment of a shoe heel showing my new design attached to a shoe shown in broken lines;

FIG. 2 is a front view thereof;

FIG. 3 is a rear view thereof;

FIG. 4 is a left side view thereof;

FIG. 5 is a right side view thereof;

FIG. 6 is a top view thereof;

FIG. 7 is a bottom view thereof;

FIG. 8 is a perspective view of a second embodiment of a shoe heel showing my new design attached to a shoe shown in broken lines;

FIG. 9 is a front view thereof;

FIG. 10 is a rear view thereof;

FIG. 11 is a left side view thereof;

FIG. 12 is a right side view thereof;

FIG. 13 is a top view thereof; and,

FIG. 14 is a bottom view thereof.

The broken lines depicted in the figures showing the straps, portion of the upper and bottom parts of the shoe form no part of the claimed design.

The small dashed lines inside the sushi rolls of the heel in FIGS. 1, 4, 5, 8, 11, and 12 represent a textured pattern of grains of rice.

1 Claim, 8 Drawing Sheets

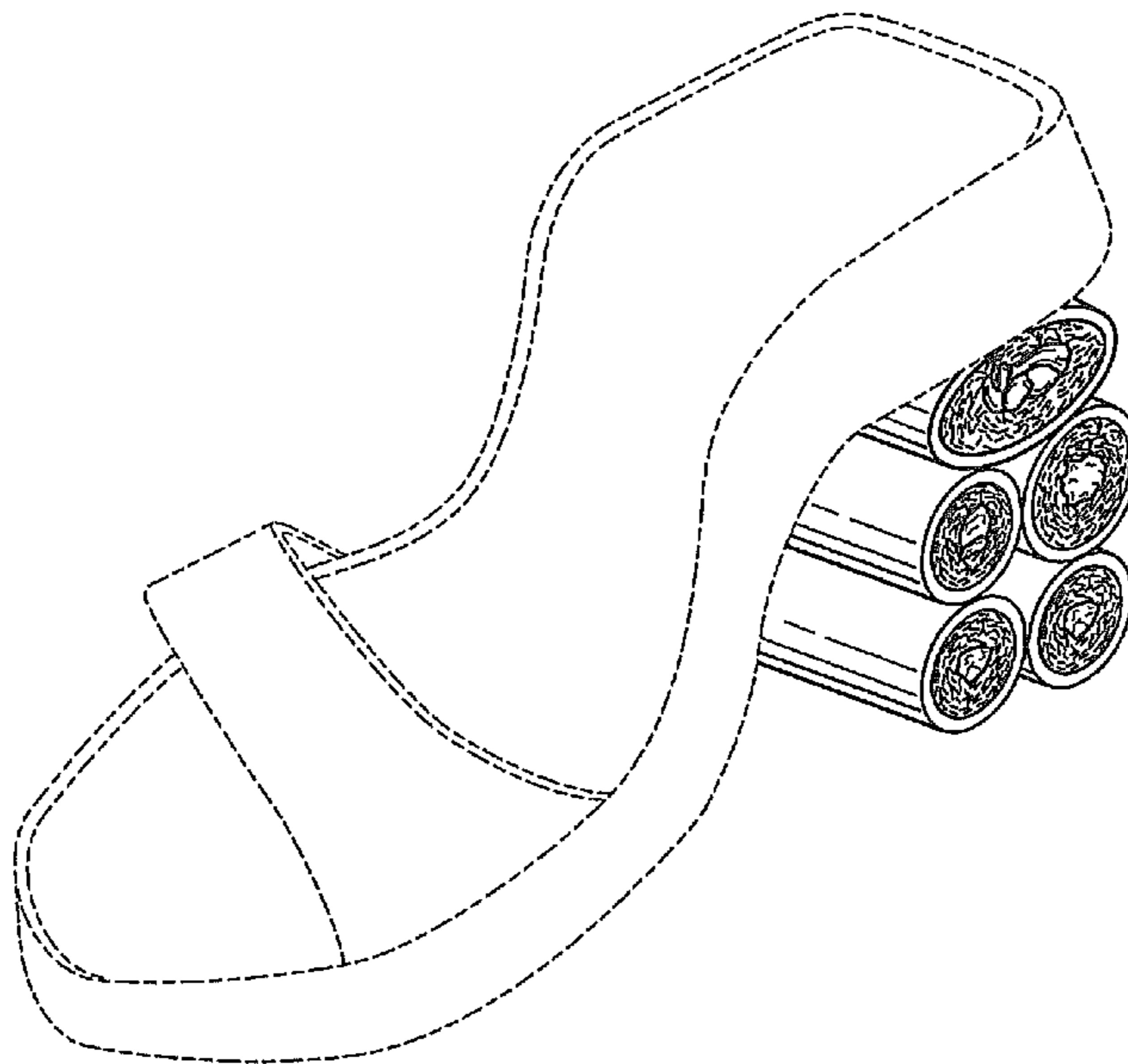

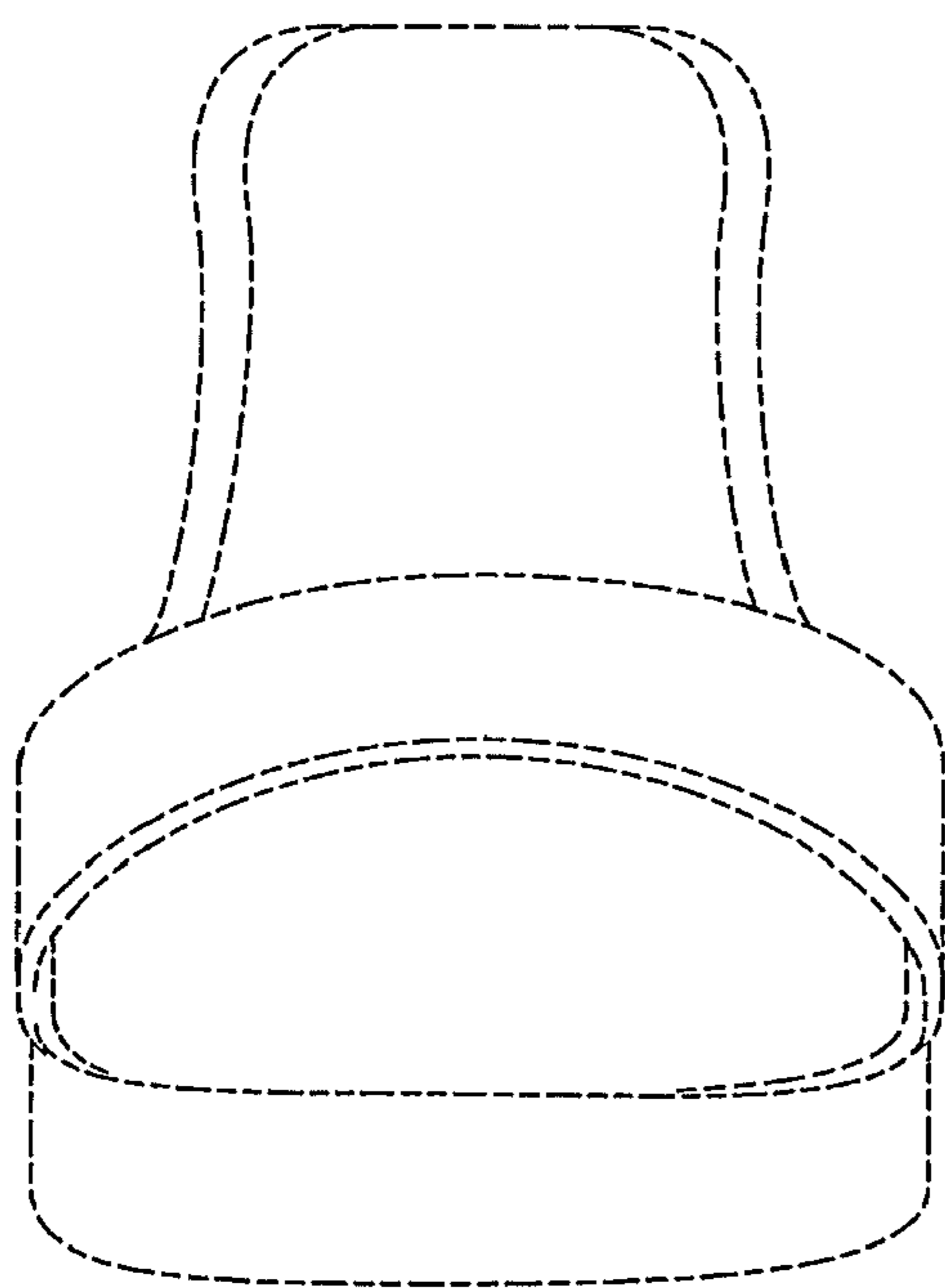

FIG. 2

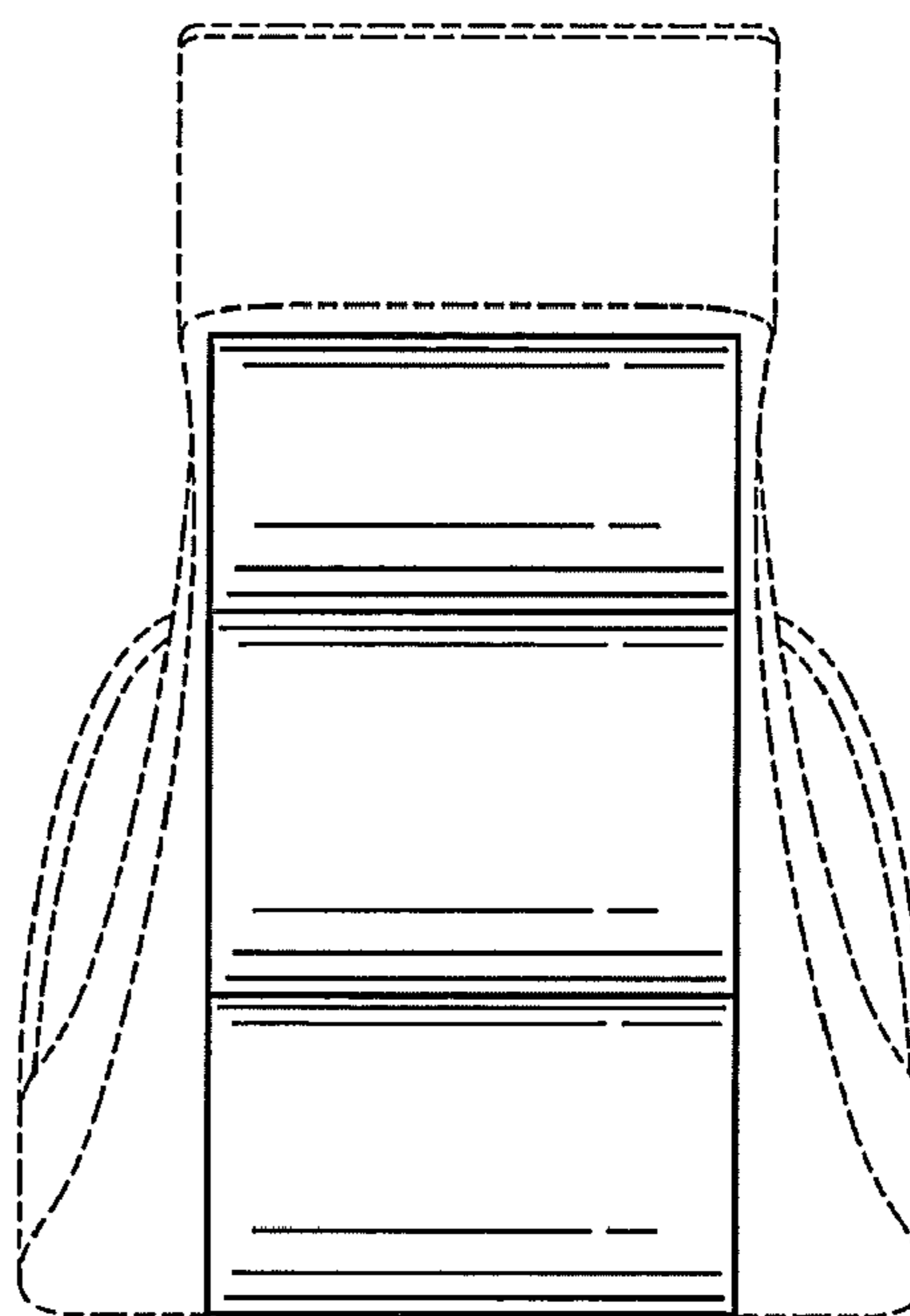

FIG. 3

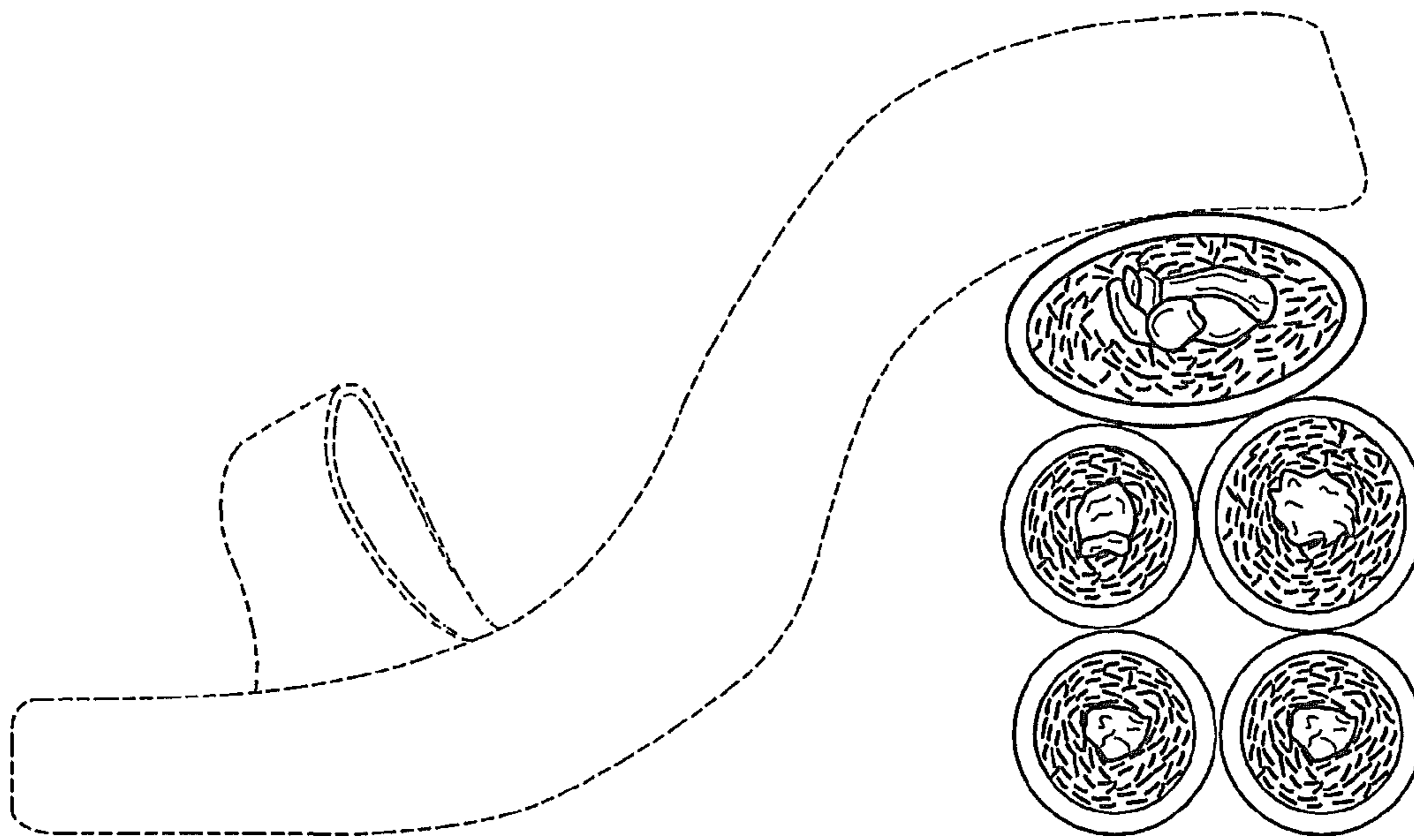

FIG. 4

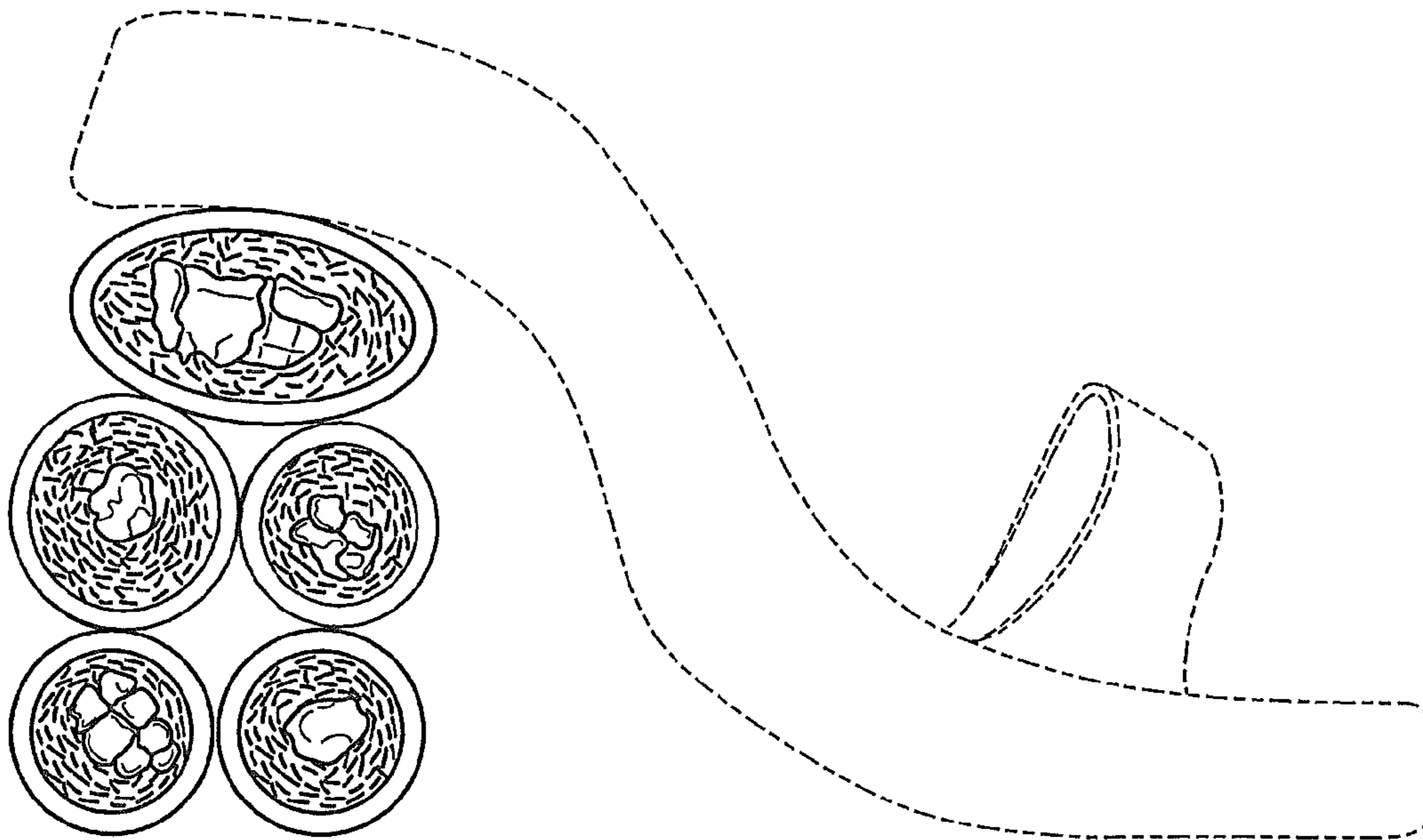

FIG. 5

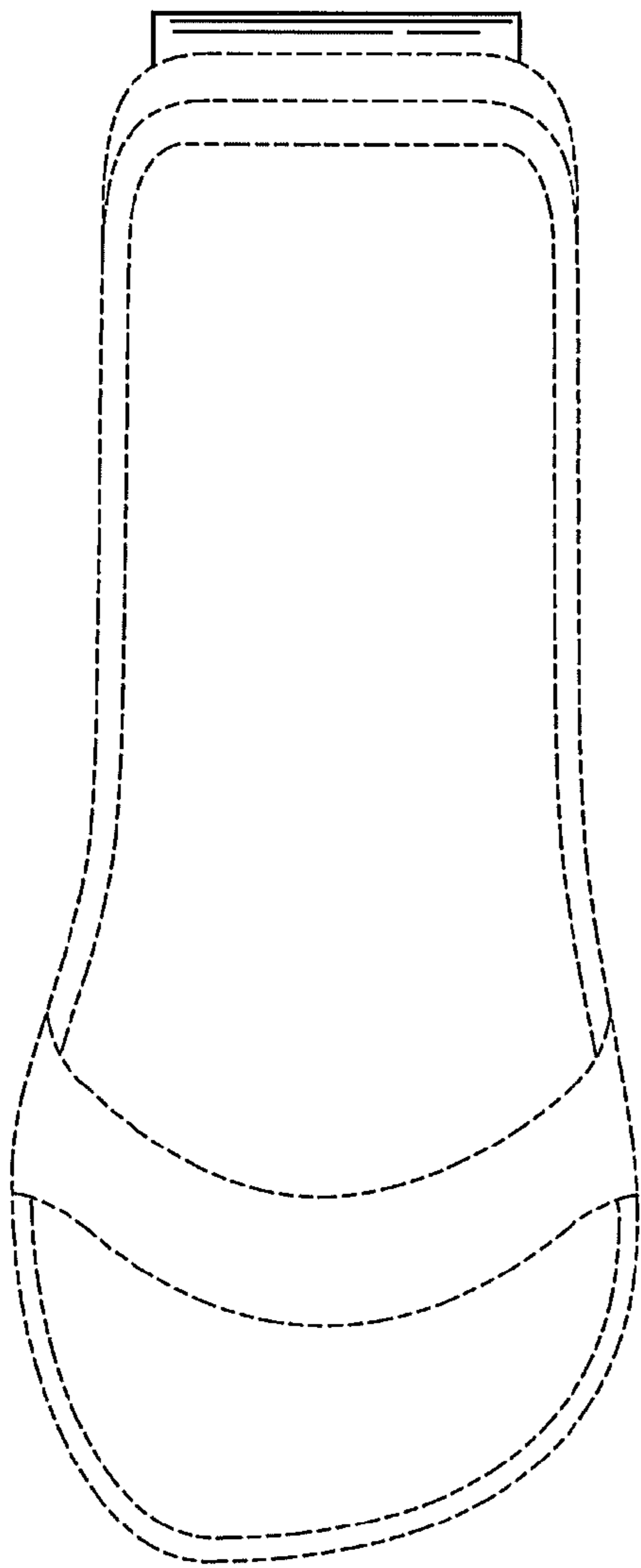

FIG. 6

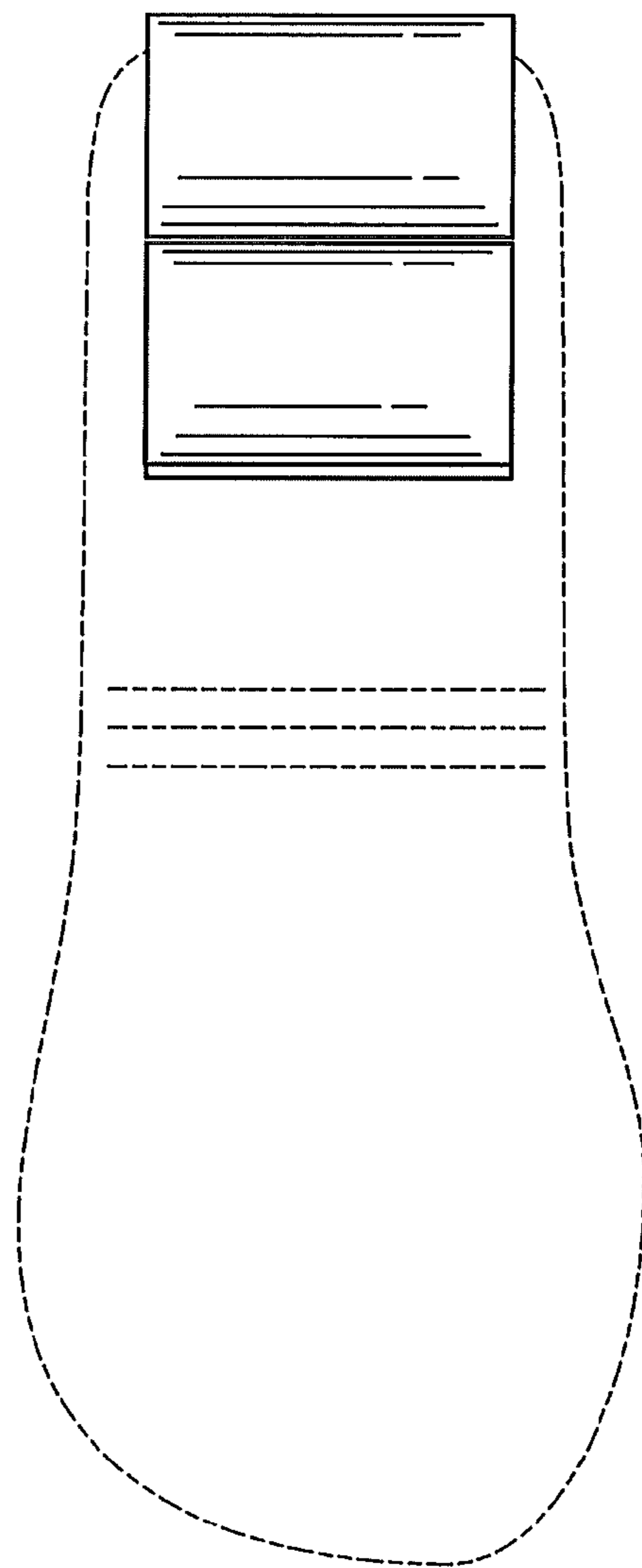

FIG. 7

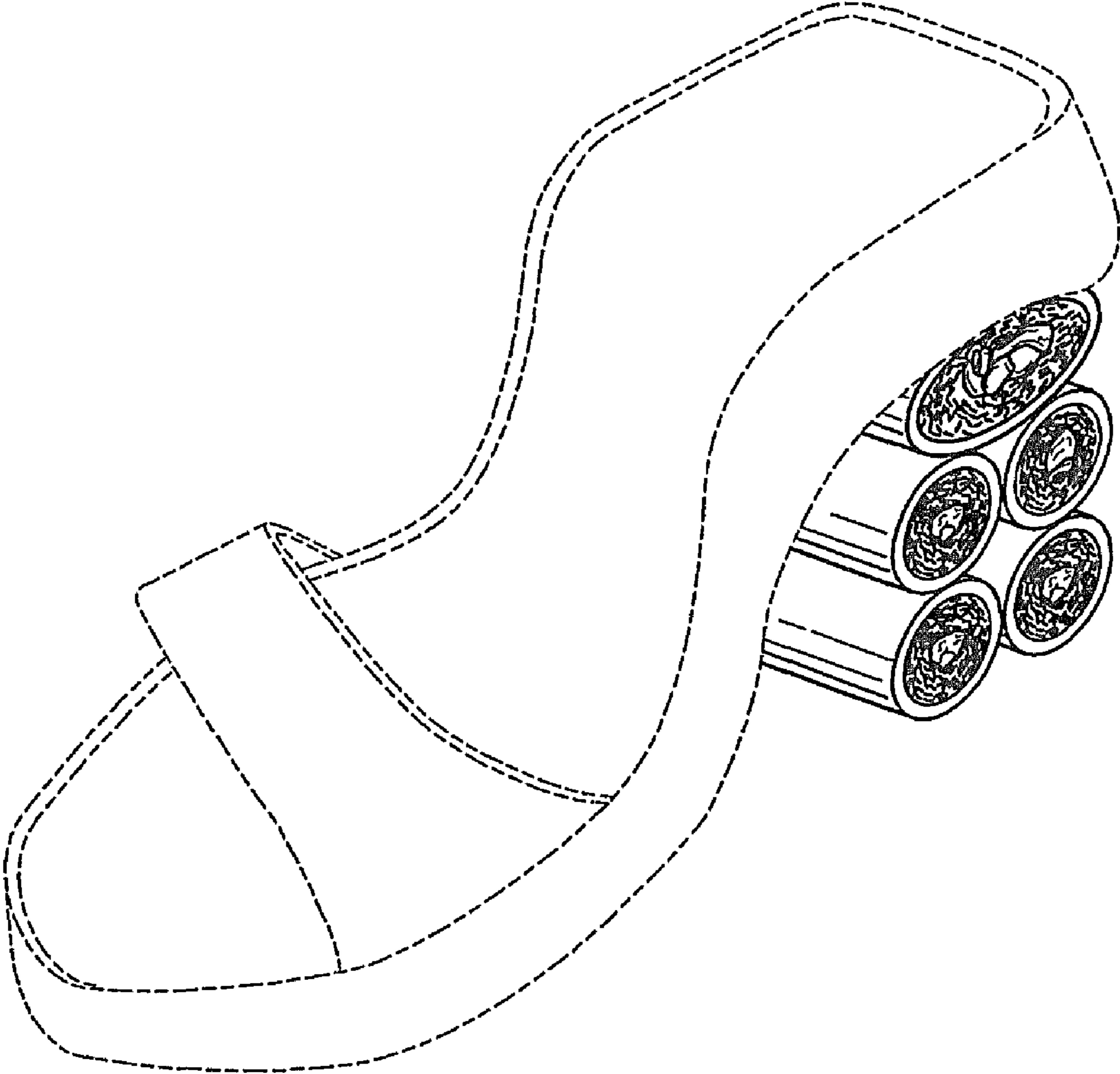

FIG. 8

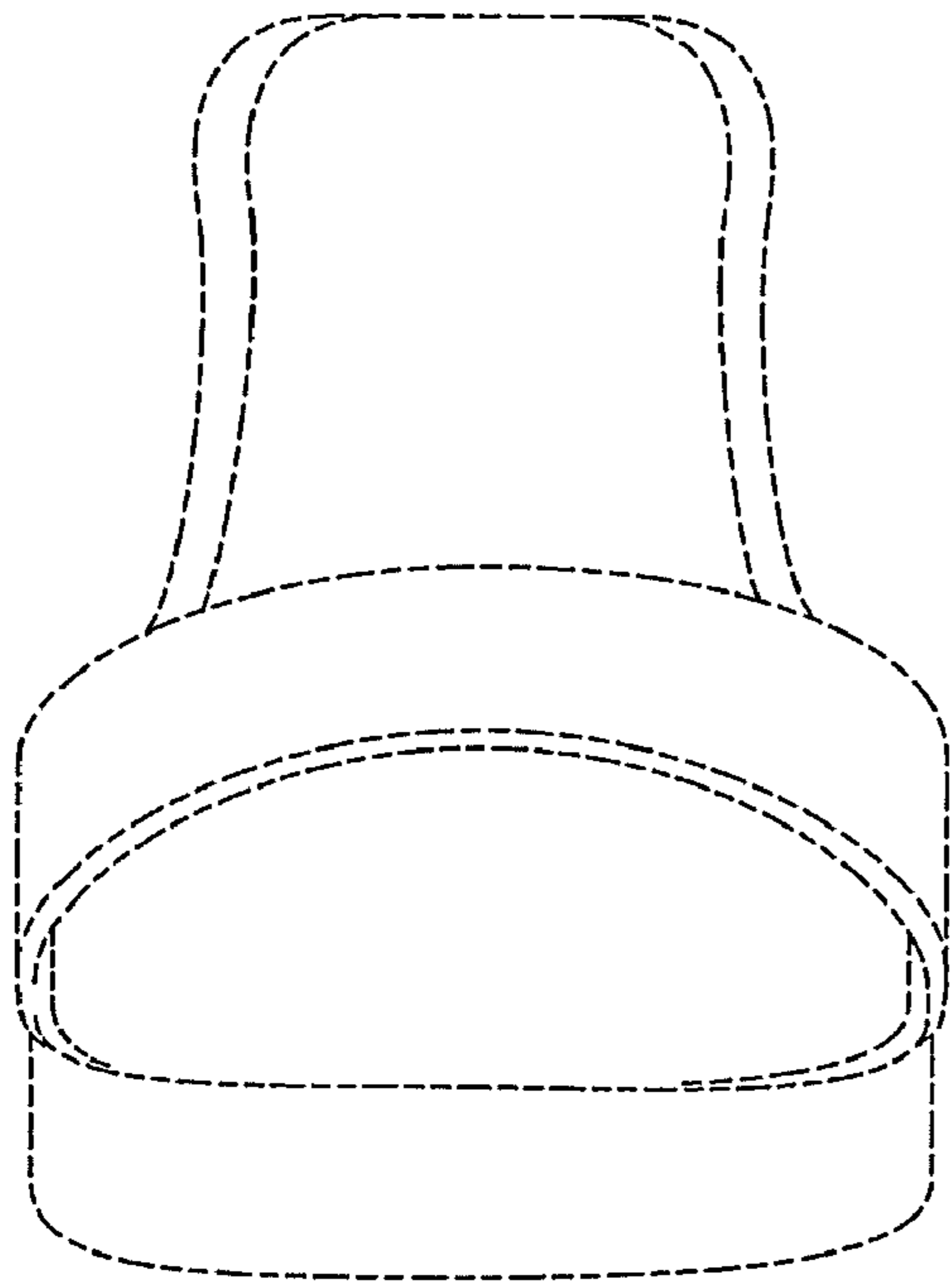

FIG. 9

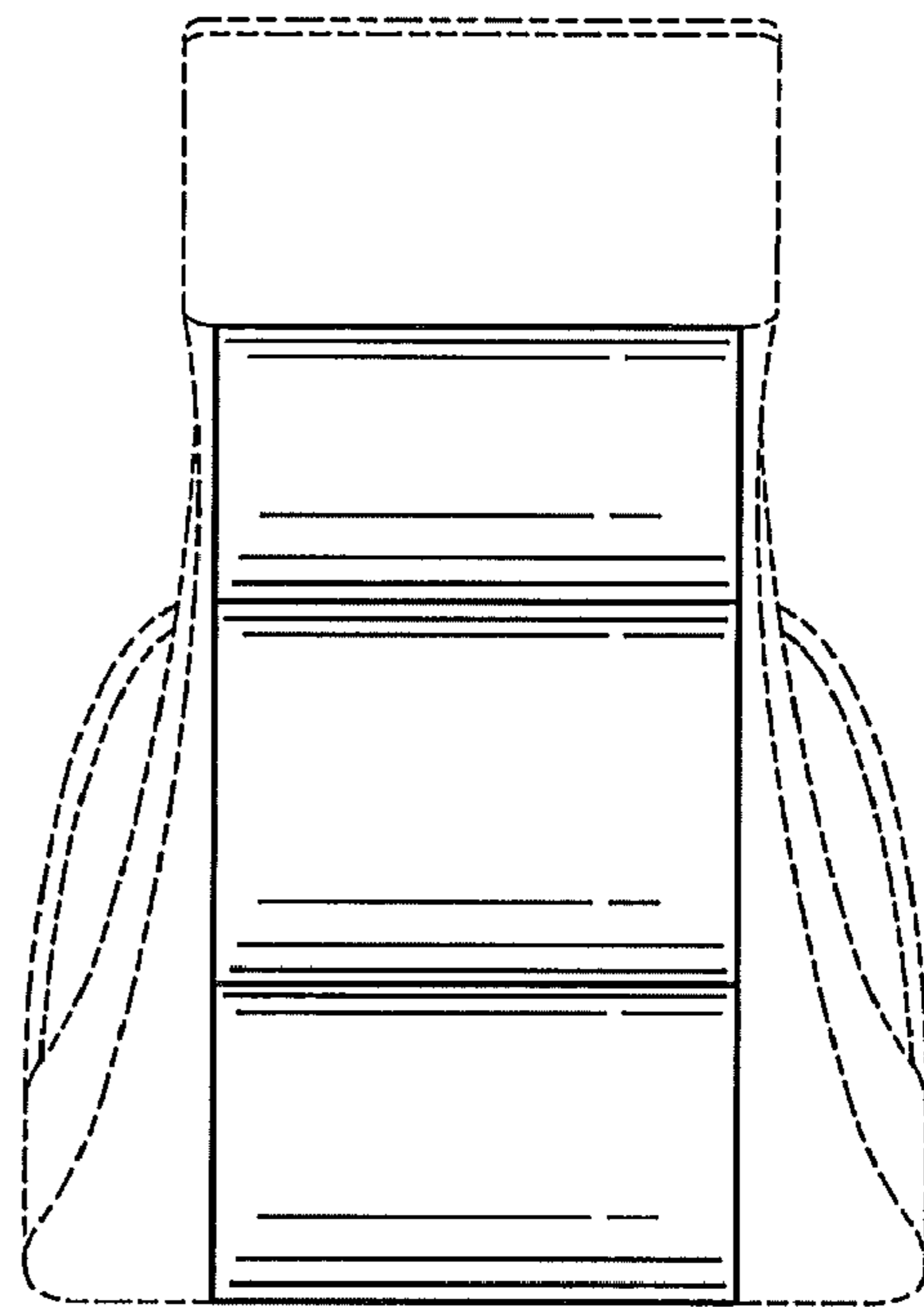

FIG. 10

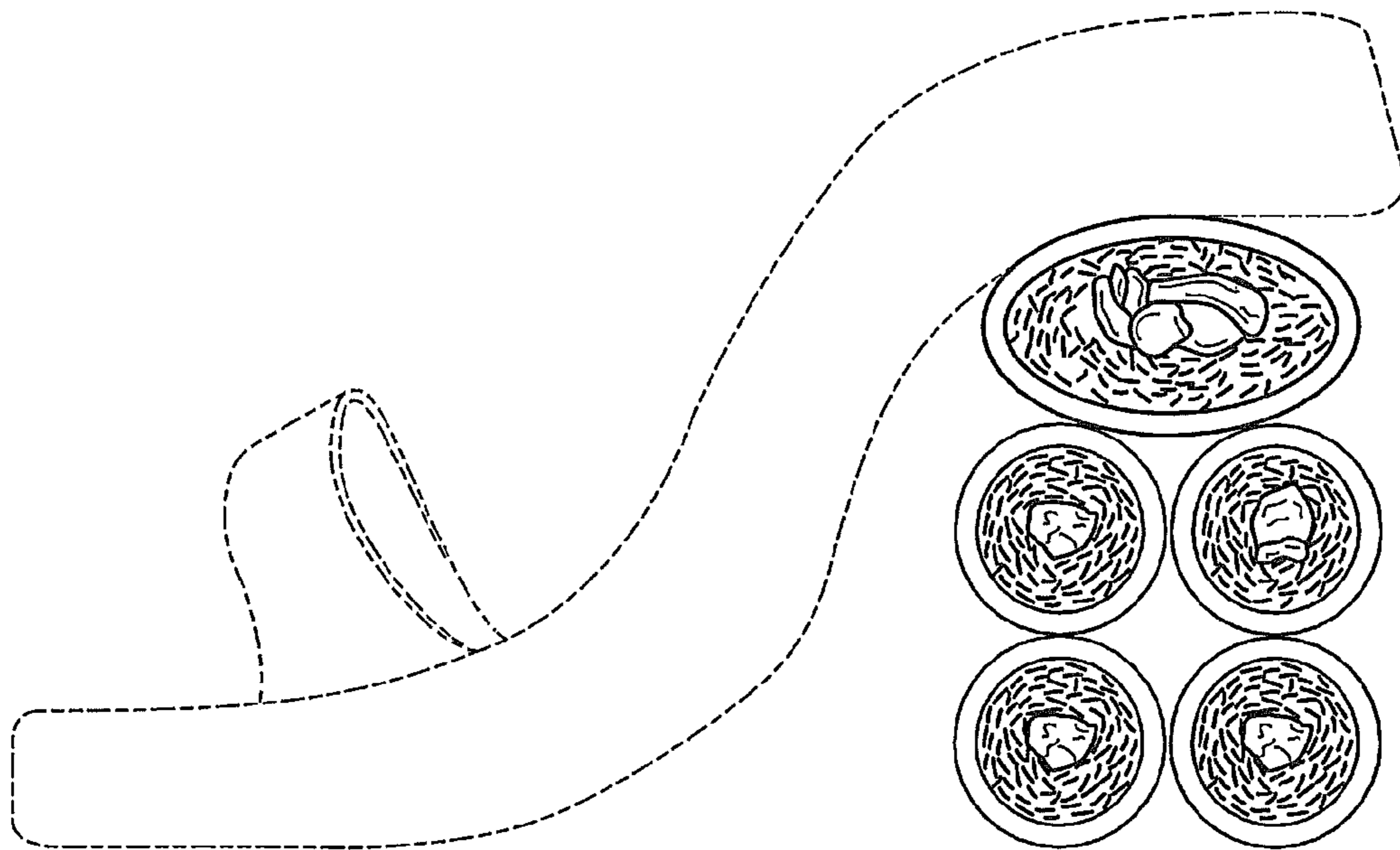

FIG. 11

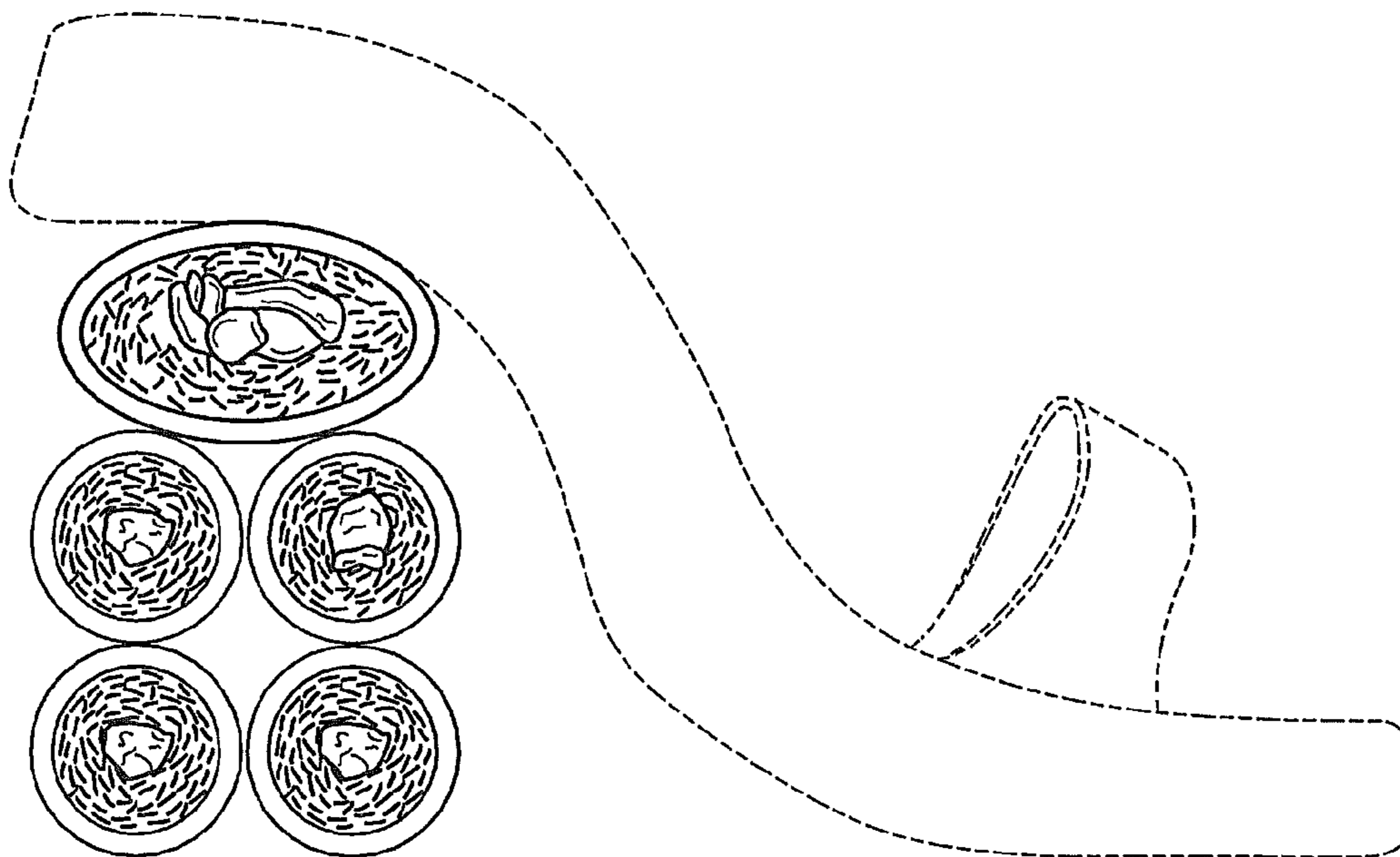

FIG. 12

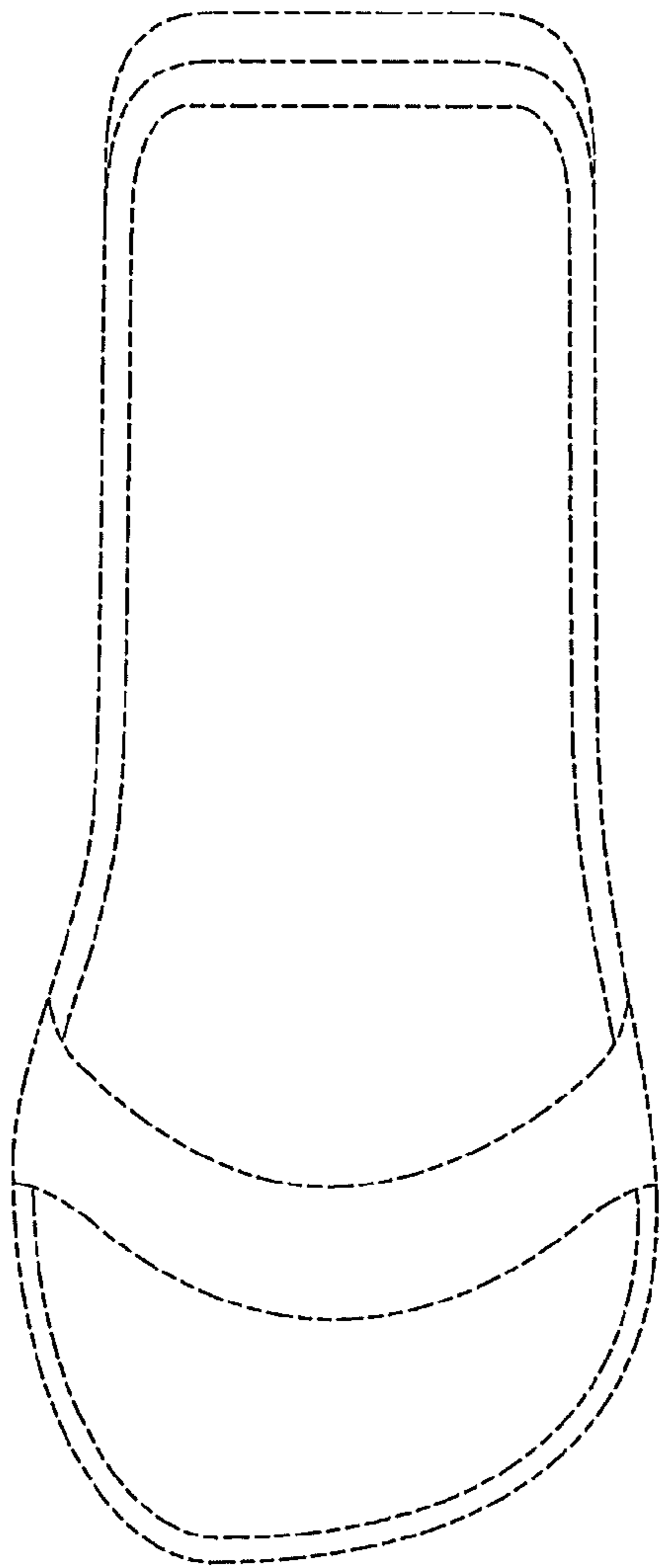

FIG. 13

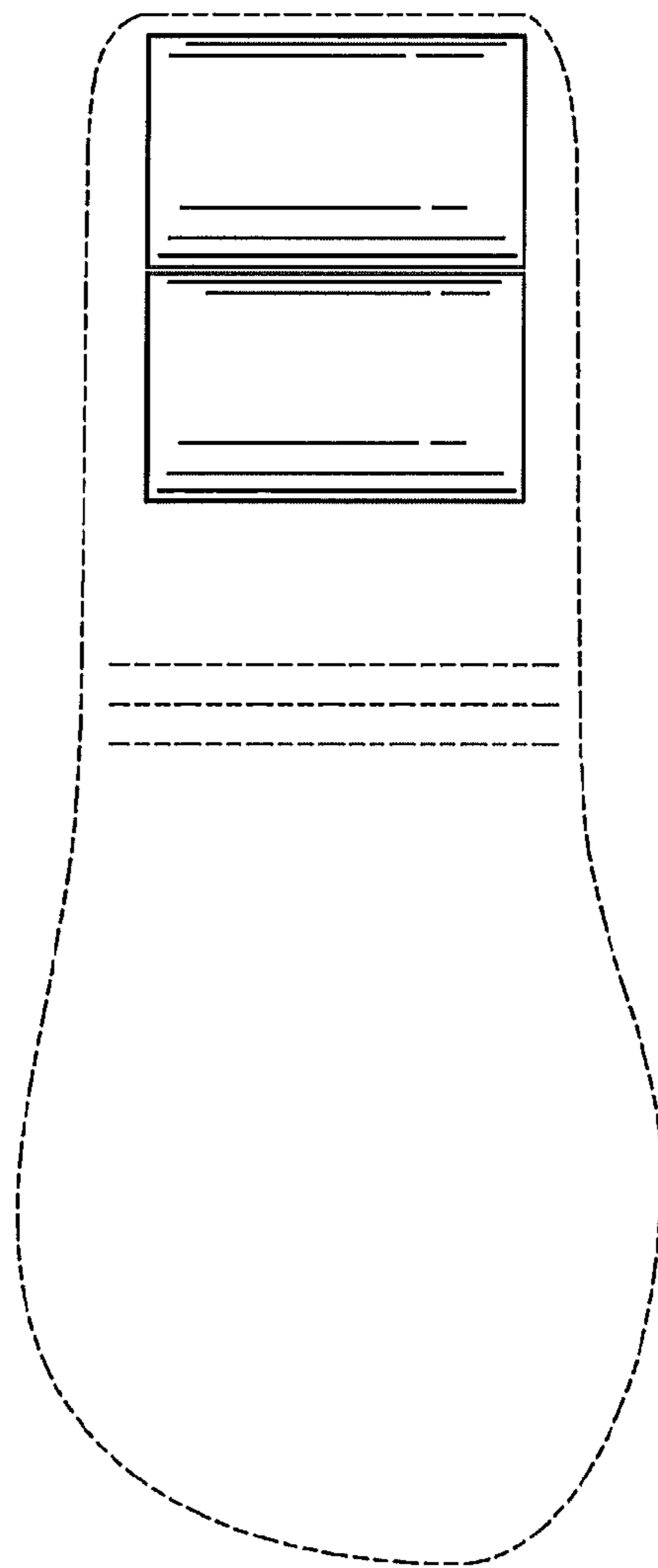

FIG. 14