

US00D675314S

(12) **United States Design Patent**  
**Stallard et al.**

(10) **Patent No.:** **US D675,314 S**  
(45) **Date of Patent:** **\*\* Jan. 29, 2013**

(54) **FRAME FOR RESPIRATORY MASK**

(75) Inventors: **Philip Thomas Stallard**, Denistone East (AU); **Scott Alexander Howard**, Harbord (AU)

(73) Assignee: **ResMed Limited**, Bella Vista (AU)

(\*\*) Term: **14 Years**

(21) Appl. No.: **29/311,202**

(22) Filed: **Jan. 15, 2009**

**Related U.S. Application Data**

(63) Continuation of application No. 29/251,703, filed on Jan. 12, 2006, now Pat. No. Des. 586,906.

(51) **LOC (9) Cl.** ..... **29-02**

(52) **U.S. Cl.** ..... **D24/110.1; D24/110.4; D24/110.5**

(58) **Field of Classification Search** ..... D24/110.1, D24/110.4-110.5, 164; 128/204.18, 205.25, 128/206.24, 206.26, 206.27, 207.11, 207.13, 128/207.17

See application file for complete search history.

(56) **References Cited**

**U.S. PATENT DOCUMENTS**

D428,139	S	7/2000	Smart	
D430,663	S	9/2000	Smart	
6,374,826	B1	4/2002	Gunaratnam	
D459,800	S	7/2002	Smart	
D464,427	S	10/2002	Smart	
D464,728	S	10/2002	Paul	
D468,421	S	1/2003	Smart	
6,581,594	B1	6/2003	Drew	
D486,907	S	2/2004	Guney	
D493,885	S	8/2004	Raje	
6,860,269	B2	3/2005	Kwok et al.	
D519,207	S	4/2006	Raje et al.	
D534,274	S	12/2006	Smart	
D549,322	S	8/2007	Stallard et al.	
D558,334	S	12/2007	Stallard et al.	
D591,420	S *	4/2009	Selvarajan et al.	D24/110.1
D594,112	S *	6/2009	Nga et al.	D24/110.1

D597,660	S *	8/2009	Maurer	D24/110.1
2003/0005931	A1	1/2003	Jaffre	
2004/0118406	A1	6/2004	Lithgow et al.	
2005/0172969	A1	8/2005	Ging et al.	
2006/0231103	A1	10/2006	Matula	
2012/0103340	A1 *	5/2012	Chu et al.	128/206.21

**FOREIGN PATENT DOCUMENTS**

WO	2005/018523	3/2005
WO	2005/021075	3/2005
WO	2005/032634	4/2005

**OTHER PUBLICATIONS**

Stallard et al., Parent U.S. Appl. No. 29/251,703, filed Jan. 12, 2006.  
Chu et al., U.S. Appl. No. 29/261,578, filed Jun. 16, 2006.  
Veliss et al., U.S. Appl. No. 29/268,731, filed Nov. 13, 2006.  
Stallard et al., U.S. Appl. No. 29/268,823, filed Nov. 14, 2006.  
Stallard et al., U.S. Appl. No. 29/272,801, filed Feb. 20, 2007.

\* cited by examiner

*Primary Examiner* — Wan Laymon

(74) *Attorney, Agent, or Firm* — Nixon & Vanderhuy P.C.

(57) **CLAIM**

The ornamental design for a frame for respiratory mask, as shown and described.

**DESCRIPTION**

FIG. 1 is a front perspective view of a frame for a respiratory mask according to our new ornamental design;

FIG. 2 is a front view thereof;

FIG. 3 is a rear view thereof;

FIG. 4 is a top view thereof;

FIG. 5 is a rear perspective view thereof; and,

FIG. 6 is a side view thereof.

The broken (dash-dash) lines showing environment or structure are for illustrative purposes only and form no part of the claimed design.

The dash-dot-dash lines indicate the boundary between claimed and unclaimed subject matter and form no part of the claimed design.

**1 Claim, 6 Drawing Sheets**

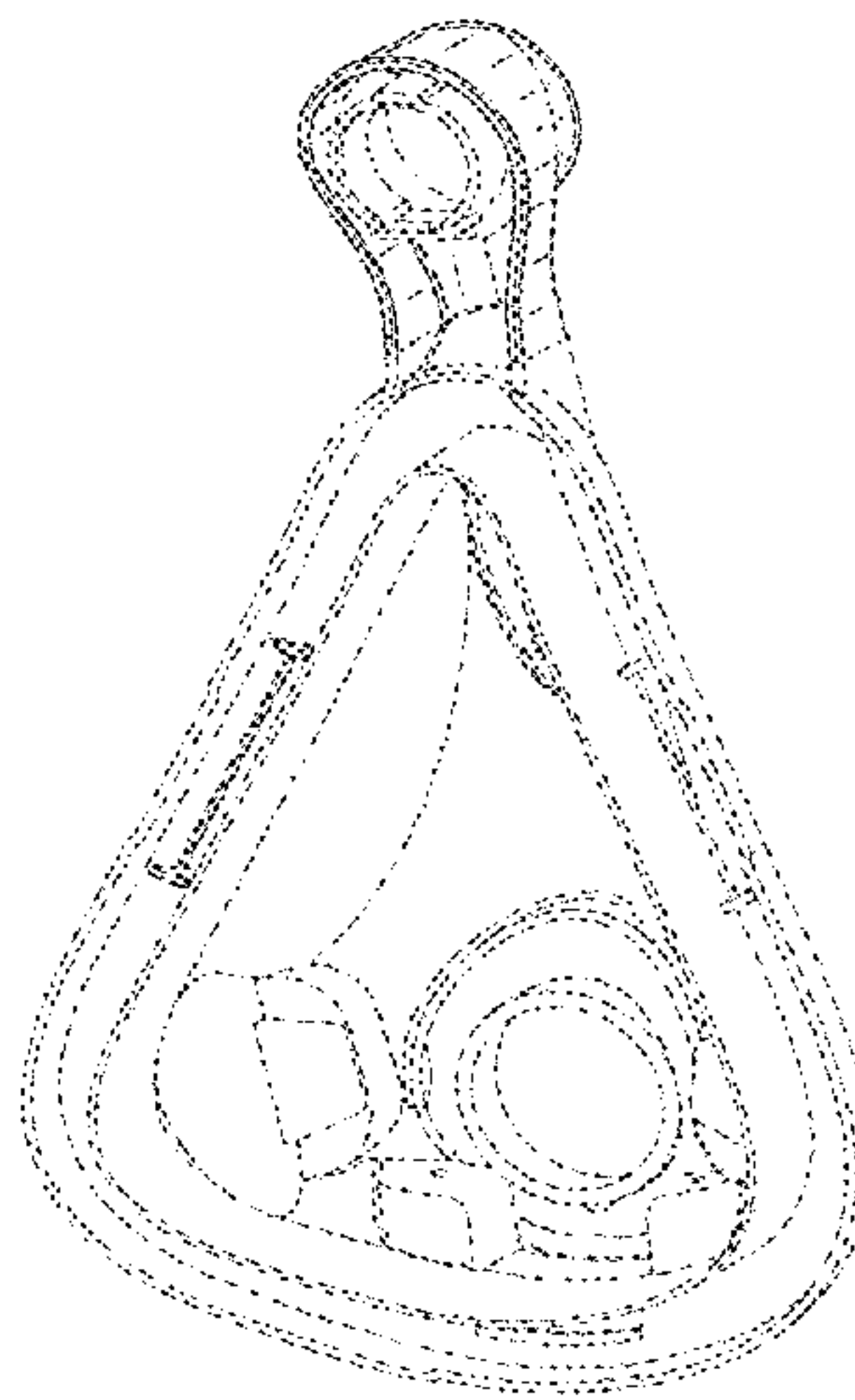
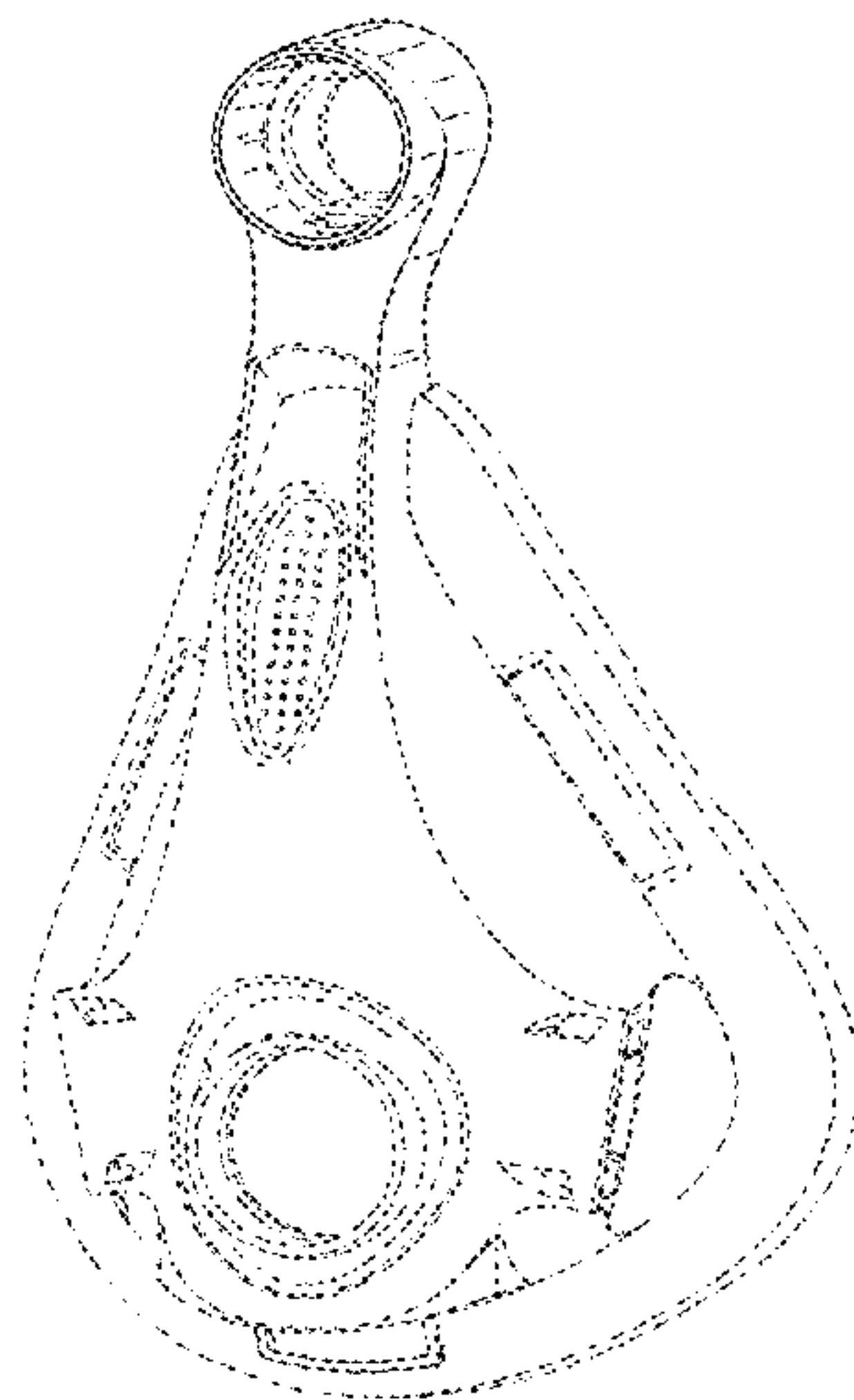

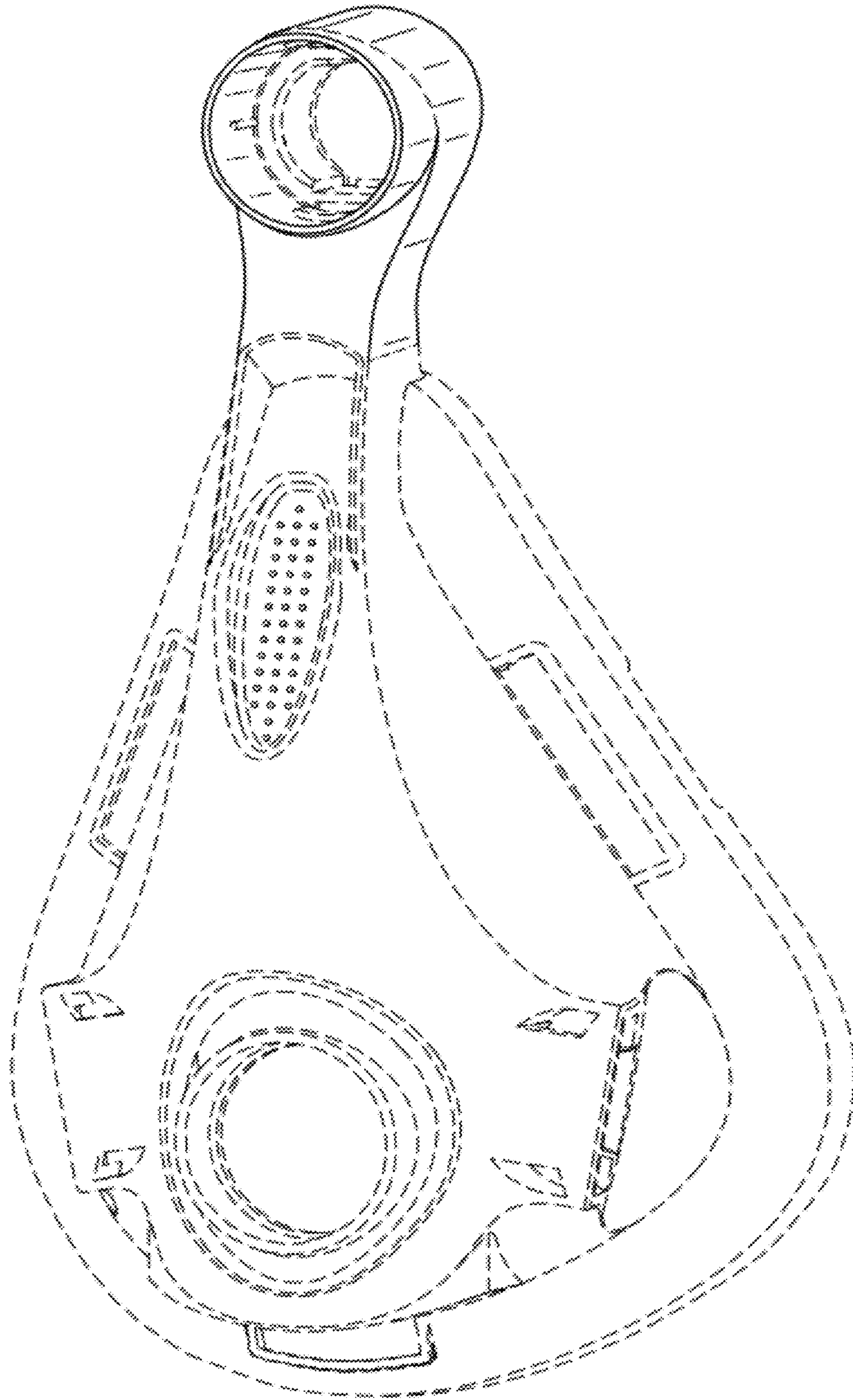

**Fig. 1**



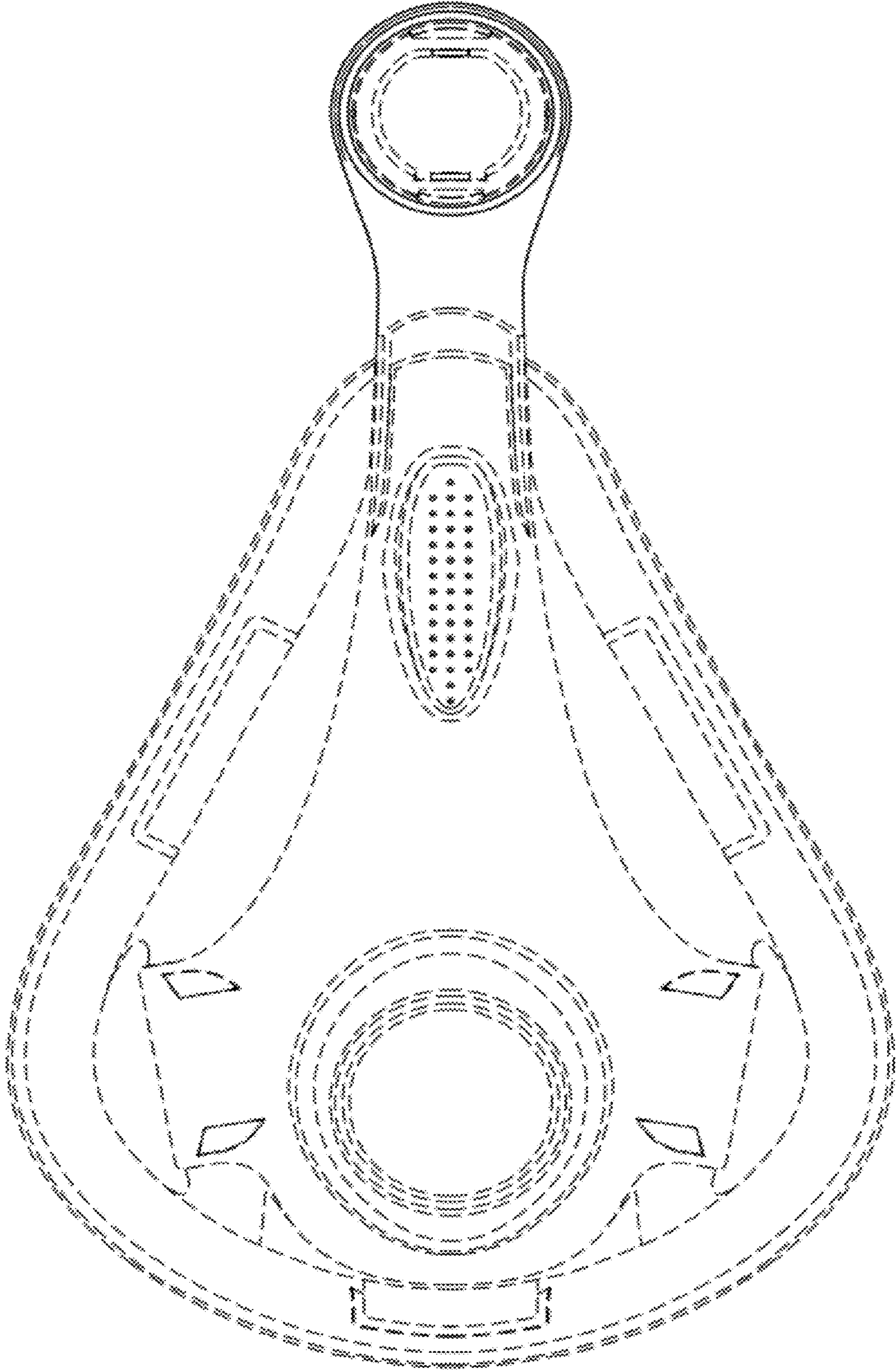
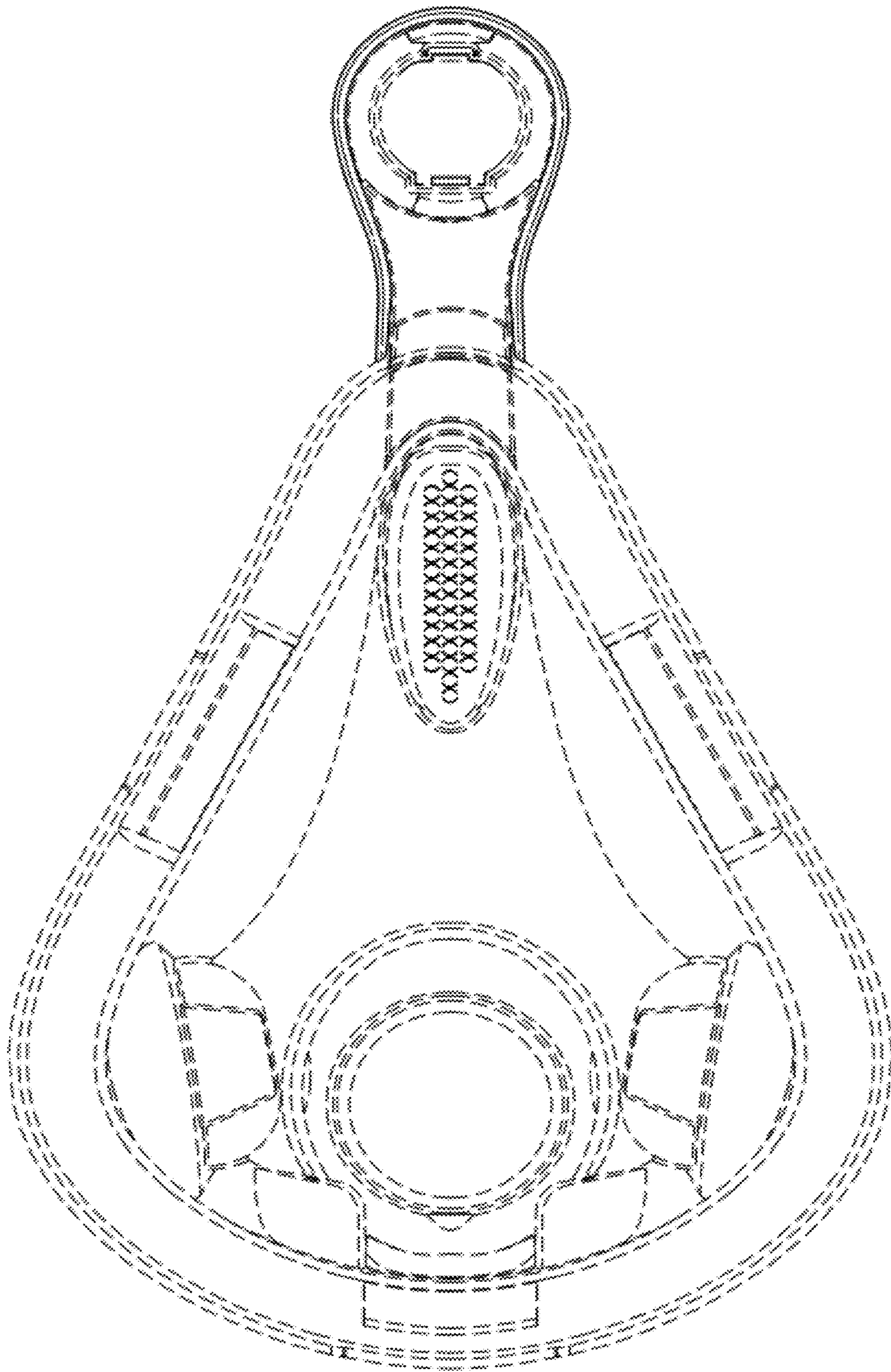
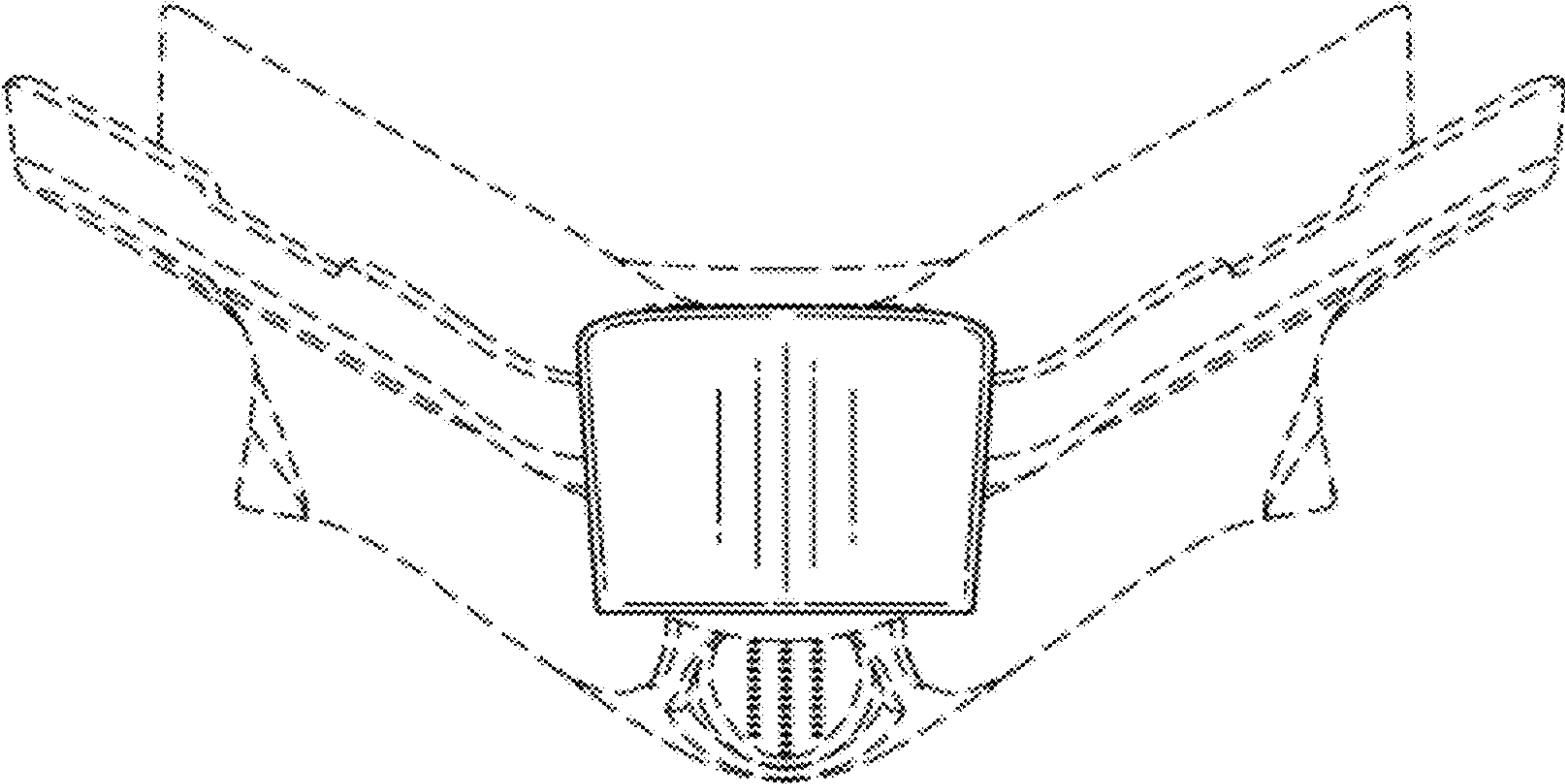

Fig. 2

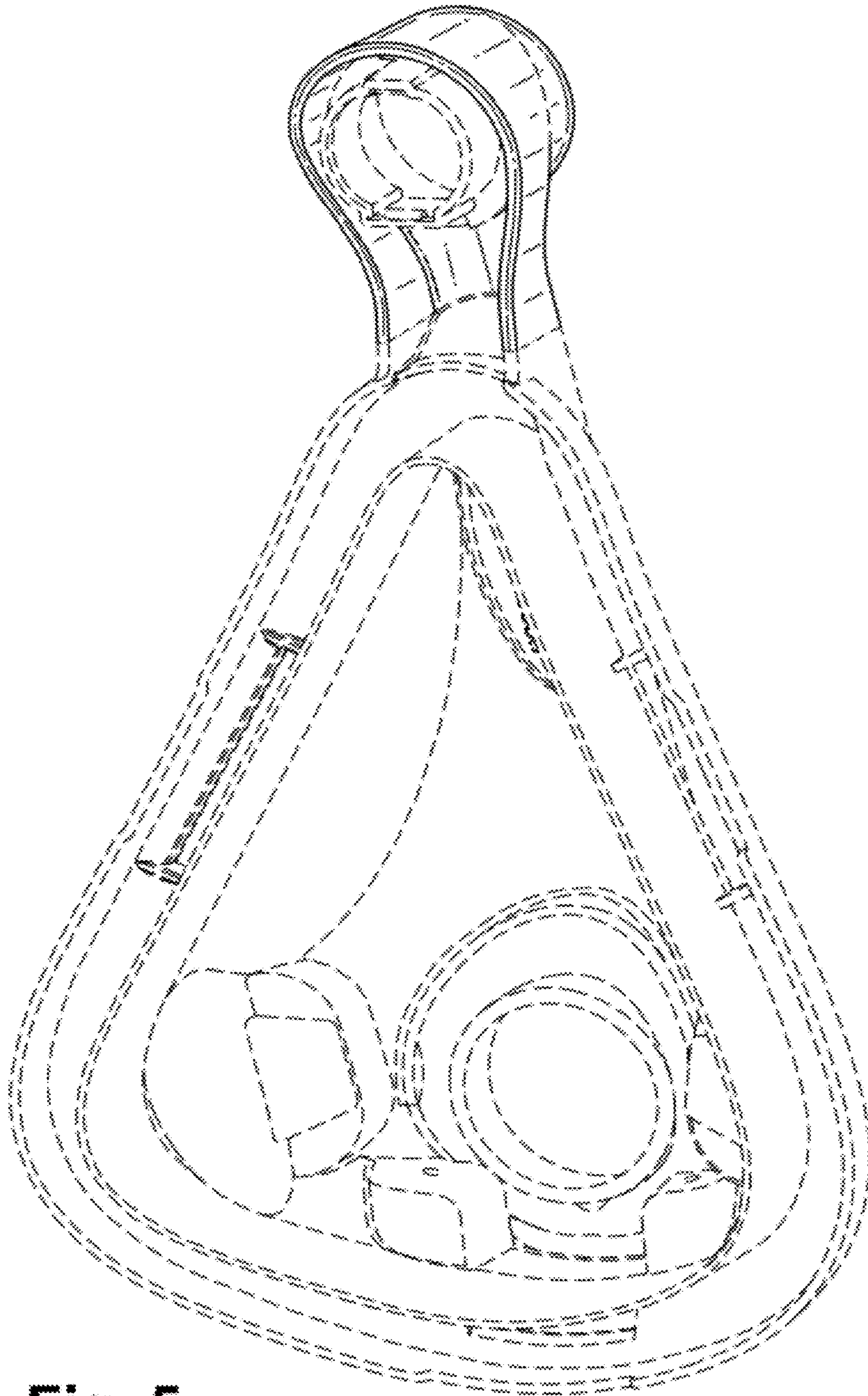

**Fig. 3**

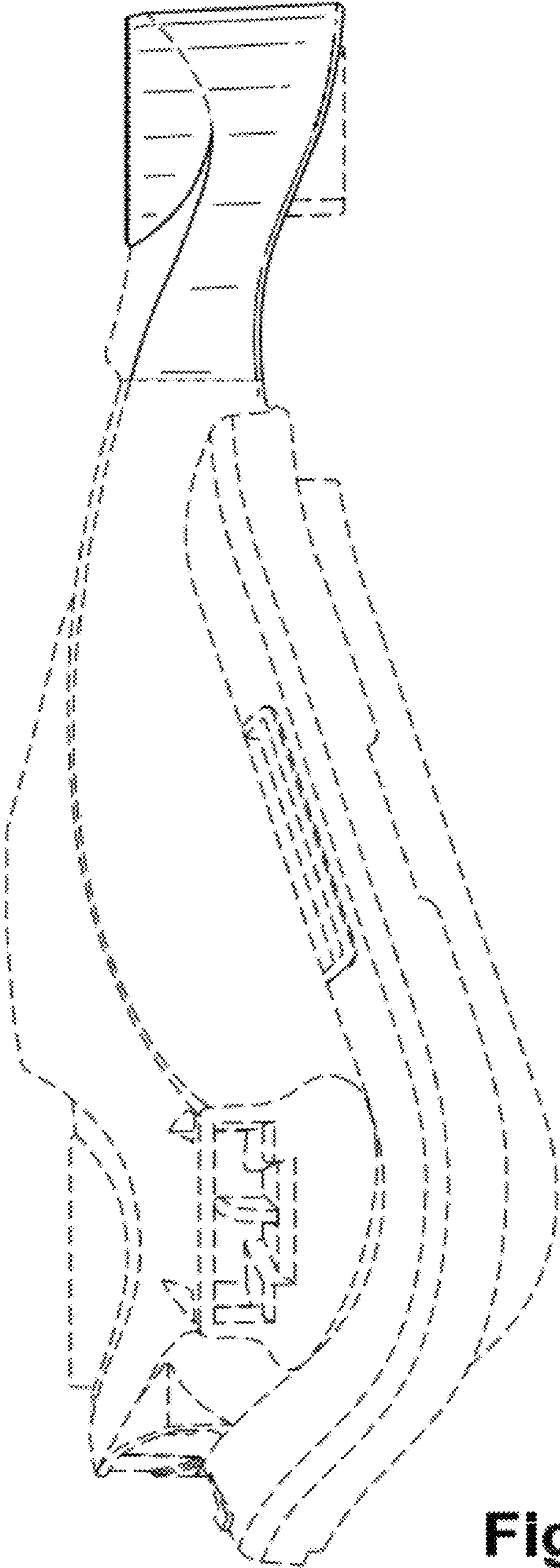

**Fig. 4**





**Fig. 5**



**Fig. 6**