



US00D675297S

(12) **United States Design Patent**
Kim

(10) **Patent No.:** **US D675,297 S**

(45) **Date of Patent:** **** Jan. 29, 2013**

(54) **HORIZONTAL WATER-GATHERING PIPE**

(75) Inventor: **Seung Hyun Kim**, Gyeongsan-si (KR)

(73) Assignee: **Industry-Academic Cooperation Foundation, Yeungnam University**, Gyeongsan-si, Gyeongsangbuk-do (KR)

(**) Term: **14 Years**

(21) Appl. No.: **29/384,446**

(22) Filed: **Jan. 31, 2011**

(30) **Foreign Application Priority Data**

Nov. 24, 2010 (KR) 30-2010-0050655

(51) **LOC (9) Cl.** **23-01**

(52) **U.S. Cl.** **D23/266**

(58) **Field of Classification Search** D23/266;
138/103, 105, 122; 405/43, 45, 48, 49
See application file for complete search history.

(56) **References Cited**

U.S. PATENT DOCUMENTS

101,744	A *	4/1870	Knacker	405/43
804,092	A *	11/1905	Brants	405/43
3,020,592	A *	2/1962	Maccaferri	138/41
3,902,323	A *	9/1975	Watanabe	405/43
4,318,892	A *	3/1982	Von Kohorn	422/279

D348,925	S *	7/1994	Miller	D23/266
7,165,913	B2 *	1/2007	Allard et al.	405/45
7,909,535	B2 *	3/2011	Samara	405/45
8,132,362	B2 *	3/2012	King	47/48.5
D661,381	S *	6/2012	Motegi et al.	D23/266
2002/0172557	A1 *	11/2002	Chen	405/43
2004/0076476	A1 *	4/2004	Hallot et al.	405/157
2005/0247366	A1 *	11/2005	Tyrer et al.	138/157
2008/0095580	A1 *	4/2008	Blackwood	405/45
2009/0269146	A1 *	10/2009	Miljovski	405/233

* cited by examiner

Primary Examiner — Eric Goodman

(74) *Attorney, Agent, or Firm* — Sherr & Jiang, PLLC

(57) **CLAIM**

The ornamental design for a “horizontal water-gathering pipe,” as shown and described.

DESCRIPTION

FIG. 1 is a front view of my new design;
FIG. 2 is a back view thereof;
FIG. 3 is a left side view thereof;
FIG. 4 is a right side view thereof;
FIG. 5 is a top view thereof;
FIG. 6 is a bottom view thereof;
FIG. 7 is a perspective view thereof;
FIG. 8 is a perspective view thereof; and,
FIG. 9 is an enlarged view along line 9 as shown in FIG. 8.
The broken line showing is for illustrative purposes only and forms no part of the claimed design.

1 Claim, 7 Drawing Sheets

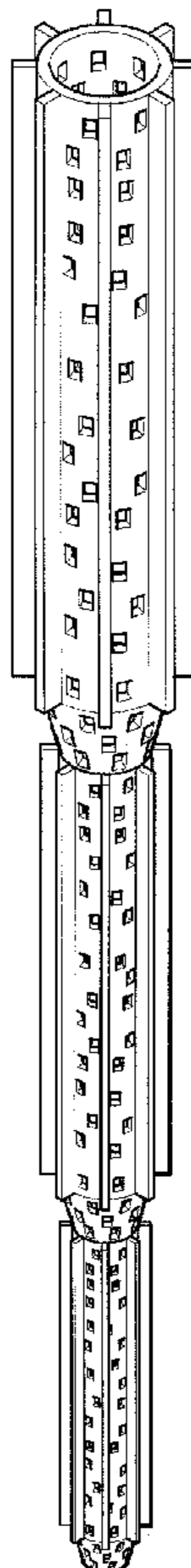

FIG. 1

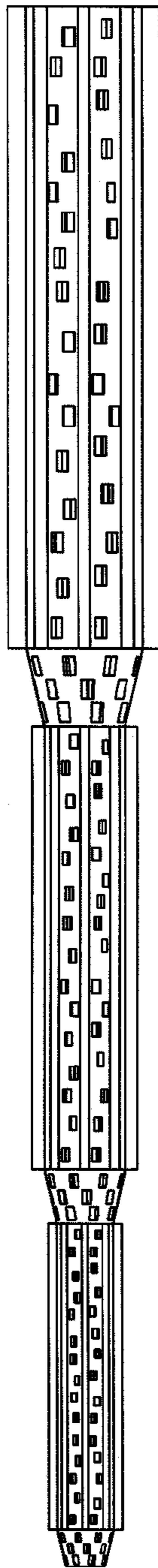

FIG. 2

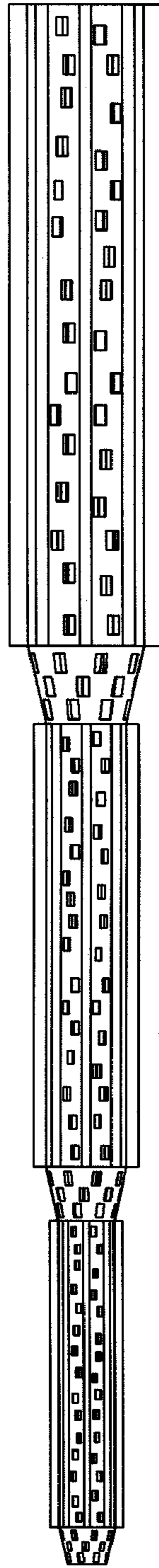

FIG. 3

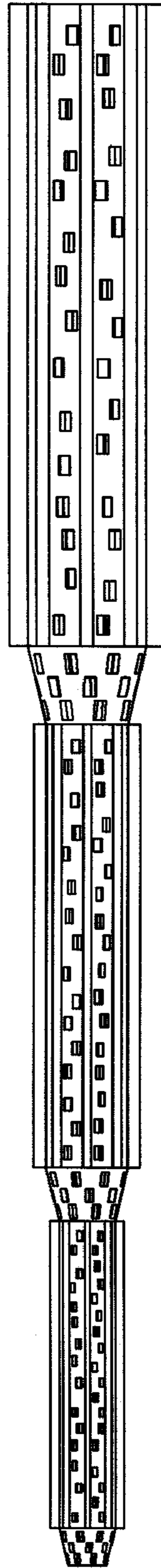

FIG. 4

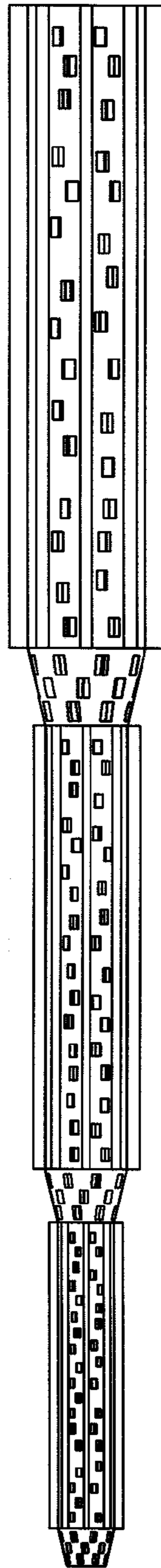

FIG. 5

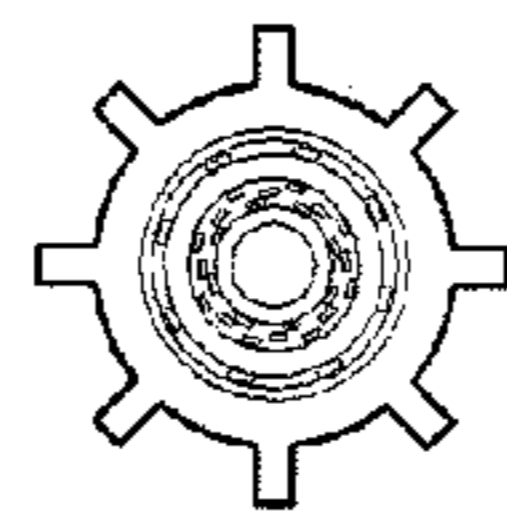

FIG. 6

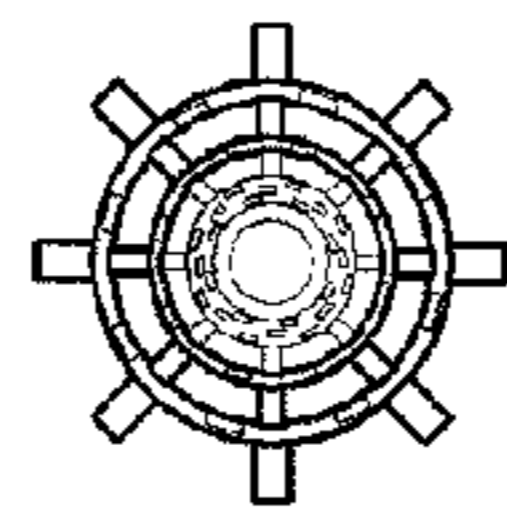

FIG. 7

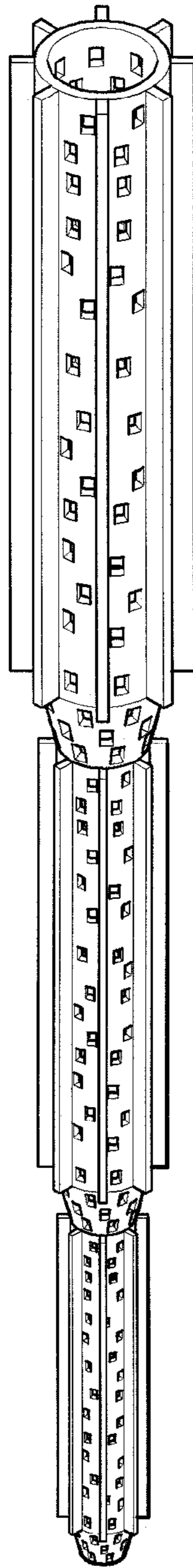

FIG. 8

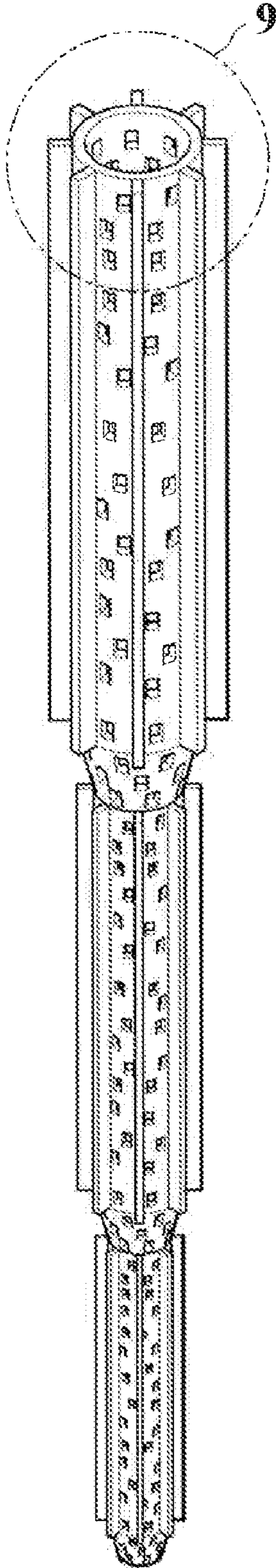

FIG. 9

