



US00D675200S

(12) **United States Design Patent**
Liu et al.

(10) **Patent No.:** **US D675,200 S**
(45) **Date of Patent:** **** Jan. 29, 2013**

(54) **NOTEBOOK COMPUTER**

(75) Inventors: **Ming-Chung Liu**, Taipei (TW);
Wei-Han Hu, Taipei (TW)

(73) Assignee: **Compal Electronics, Inc.**, Taipei (TW)

(**) Term: **14 Years**

(21) Appl. No.: **29/414,595**

(22) Filed: **Mar. 1, 2012**

(51) **LOC (9) Cl.** **14-02**

(52) **U.S. Cl.** **D14/318**

(58) **Field of Classification Search** D14/315-327;
D18/1, 2, 7, 11; 235/145 A, 145 R; 341/22,
341/23; 345/104, 156, 157, 168, 169, 173;
348/373; 361/679.5, 679.08, 679.09, 679.11,
361/679.26, 679.27, 679.49, 679.55; 715/783
See application file for complete search history.

(56) **References Cited**

U.S. PATENT DOCUMENTS

D559,245	S	*	1/2008	Iseki	D14/318
D559,247	S	*	1/2008	Kawase	D14/318
D581,410	S	*	11/2008	Kumano	D14/318
7,620,425	B2	*	11/2009	Ju	455/566
2004/0227730	A1	*	11/2004	Sugihara	345/157
2009/0129007	A1	*	5/2009	Muller	361/679.27

2011/0255727 A1* 10/2011 Azuchi 381/333

* cited by examiner

Primary Examiner — Freda S Nunn

(74) *Attorney, Agent, or Firm* — CKC & Partners Co., Ltd.

(57) **CLAIM**

The ornamental design for a notebook computer, as shown and described.

DESCRIPTION

FIG. 1 is a perspective view of a notebook computer showing our new design in a closed state;
FIG. 2 is a front view thereof;
FIG. 3 is a rear view thereof;
FIG. 4 is a left side view thereof;
FIG. 5 is a right side view thereof;
FIG. 6 is a top view thereof;
FIG. 7 is a bottom view thereof;
FIG. 8 is a perspective view thereof shown in an open state;
FIG. 9 is a front view thereof;
FIG. 10 is a rear view thereof;
FIG. 11 is a left side view thereof;
FIG. 12 is a right side view thereof;
FIG. 13 is a top view thereof; and,
FIG. 14 is a bottom view thereof.

The broken lines shown represent unclaimed subject matter and form no part of the claimed design.

1 Claim, 10 Drawing Sheets

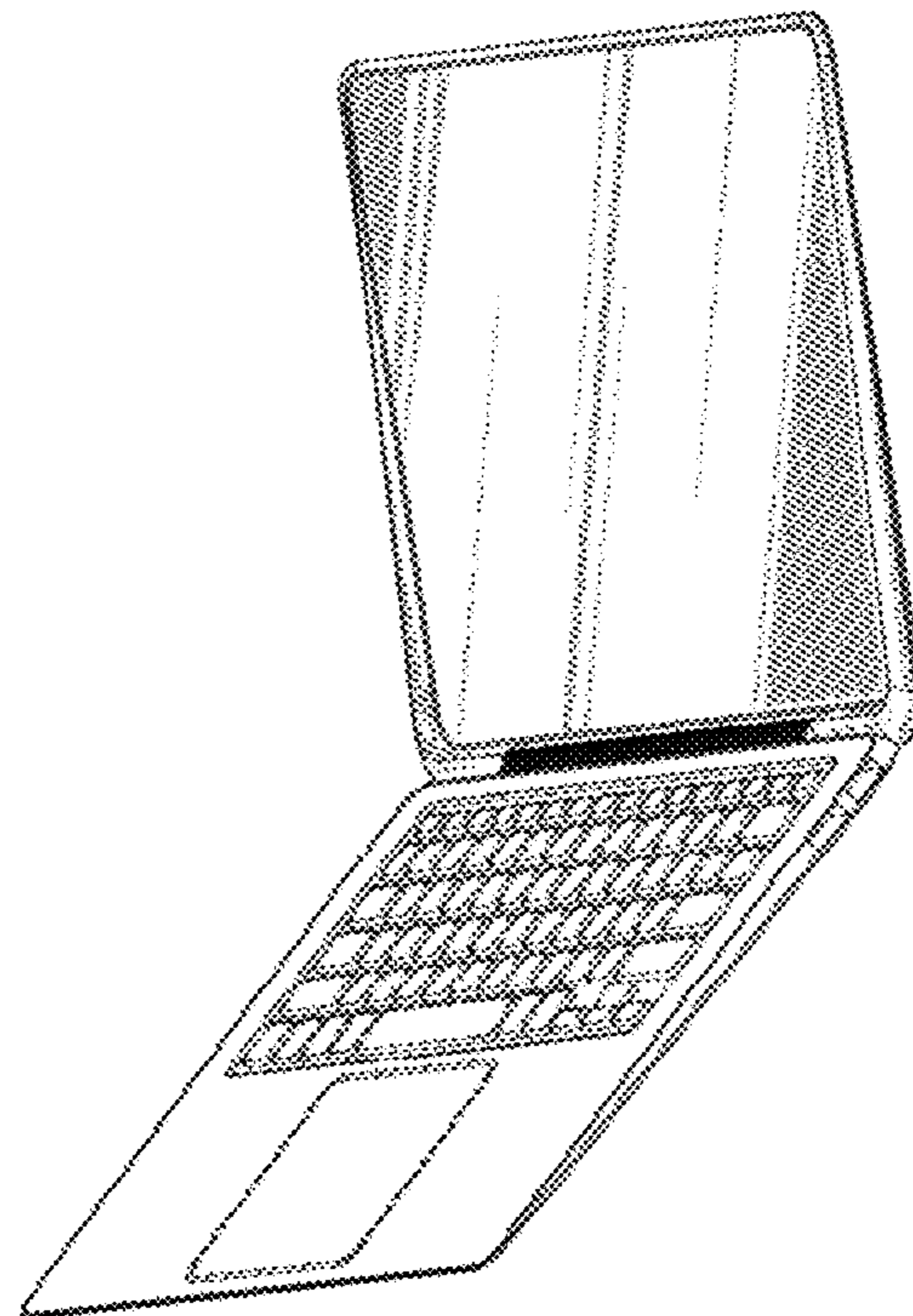

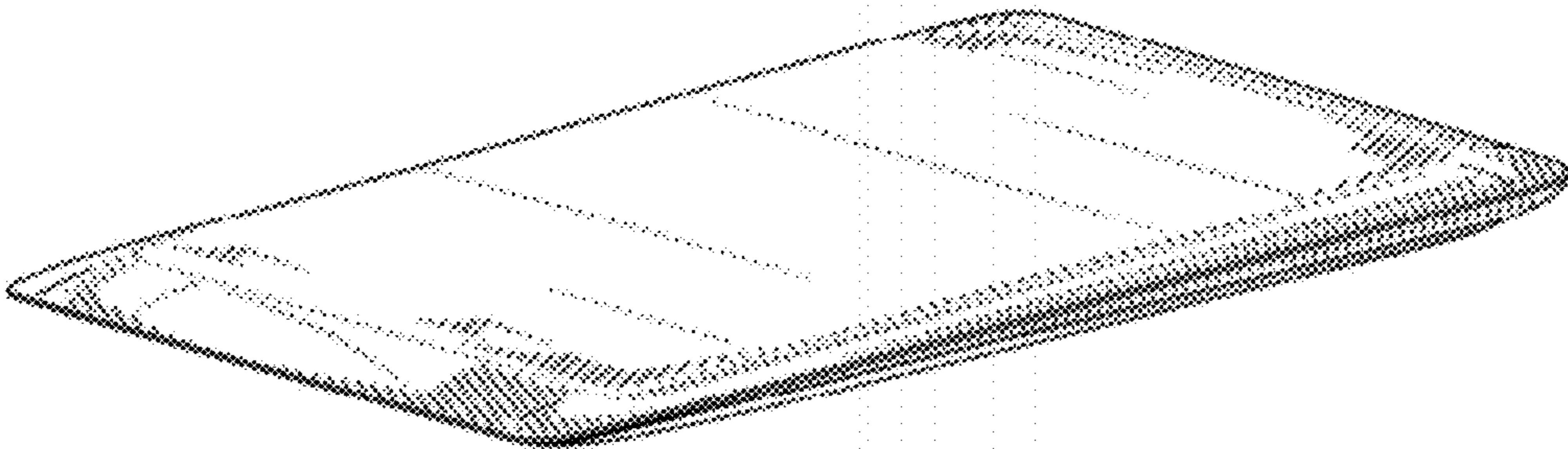

FIG. 1

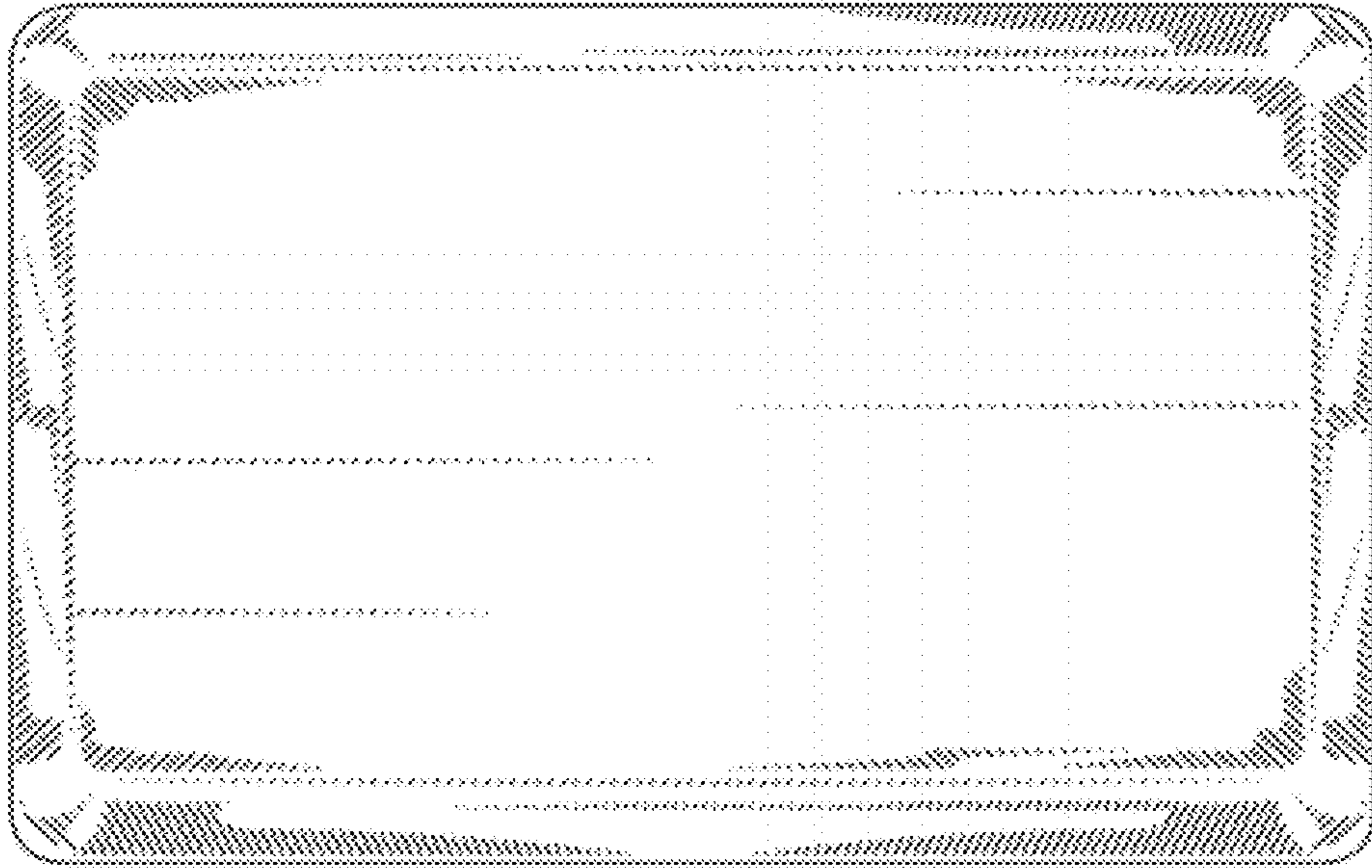

FIG. 2

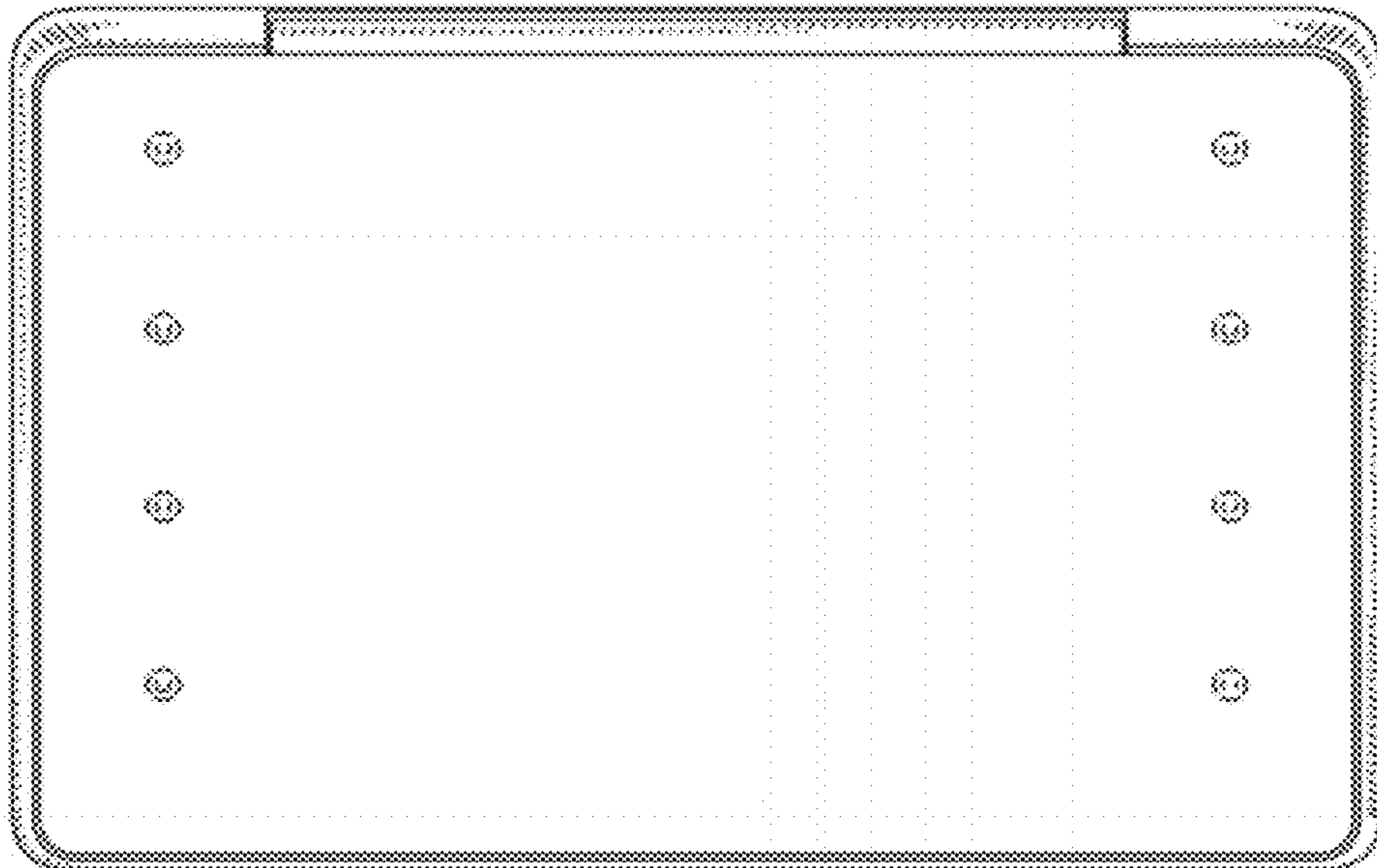

FIG. 3

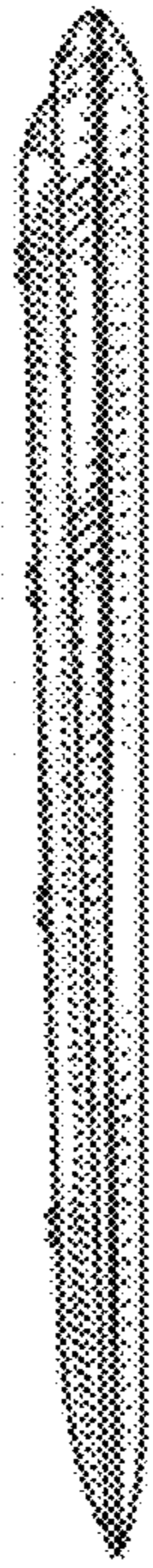

FIG. 4

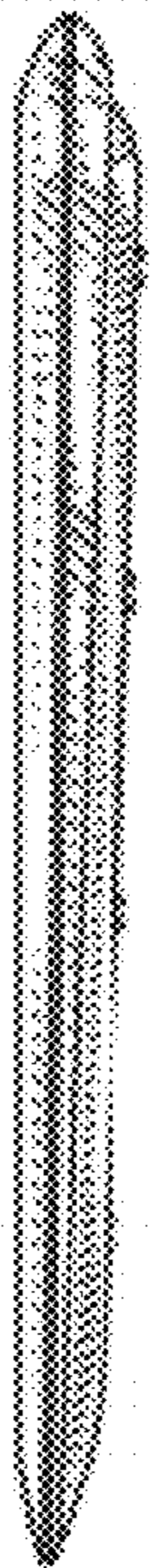

FIG. 5

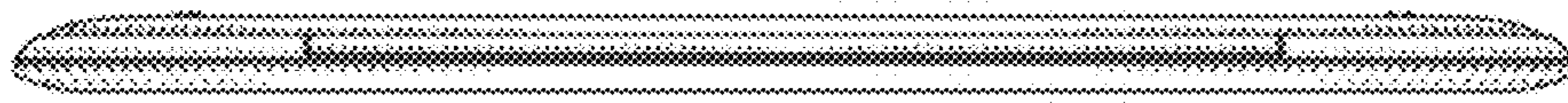

FIG. 6

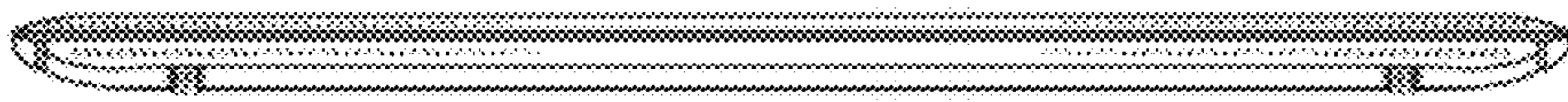

FIG. 7

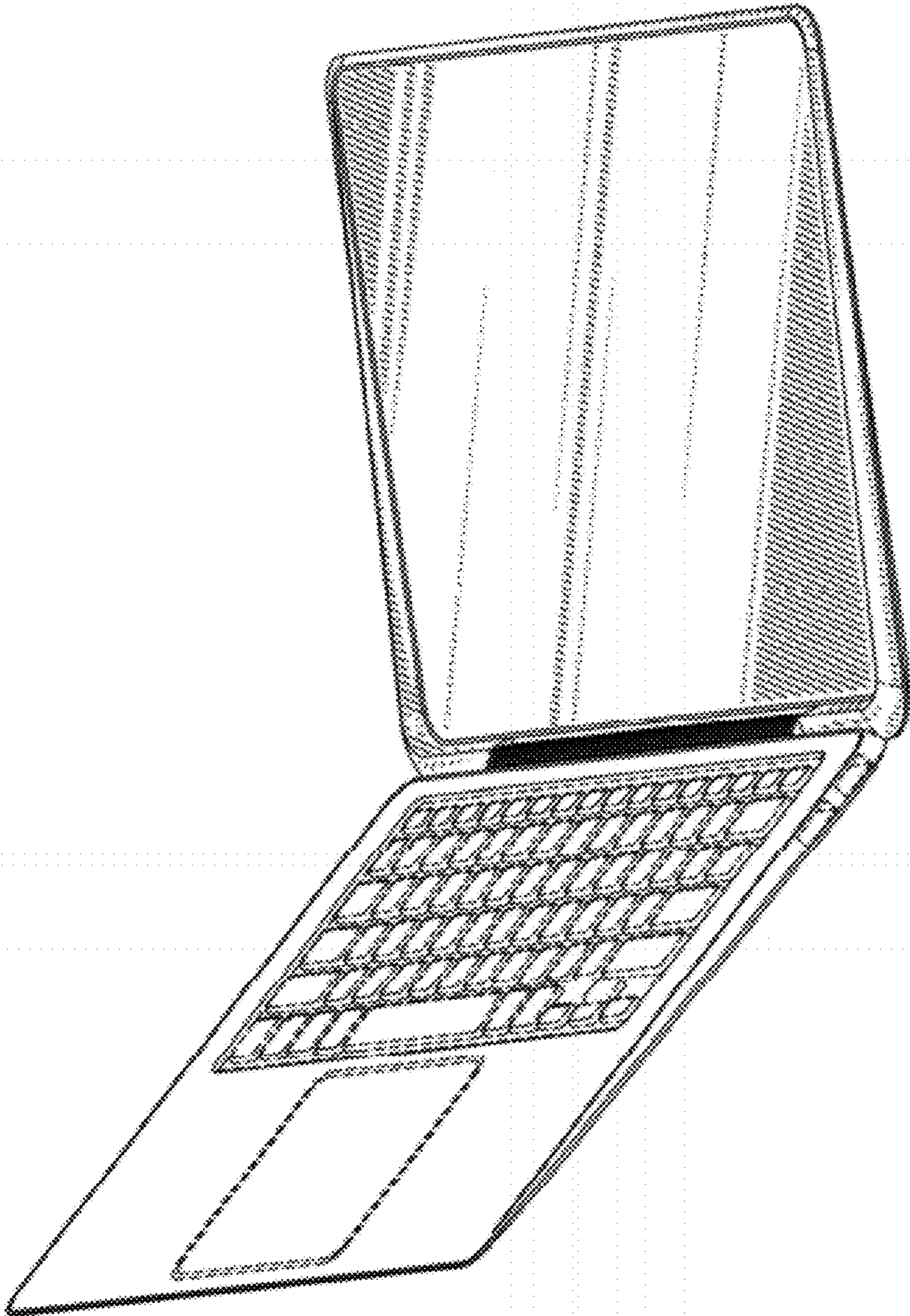

FIG. 8

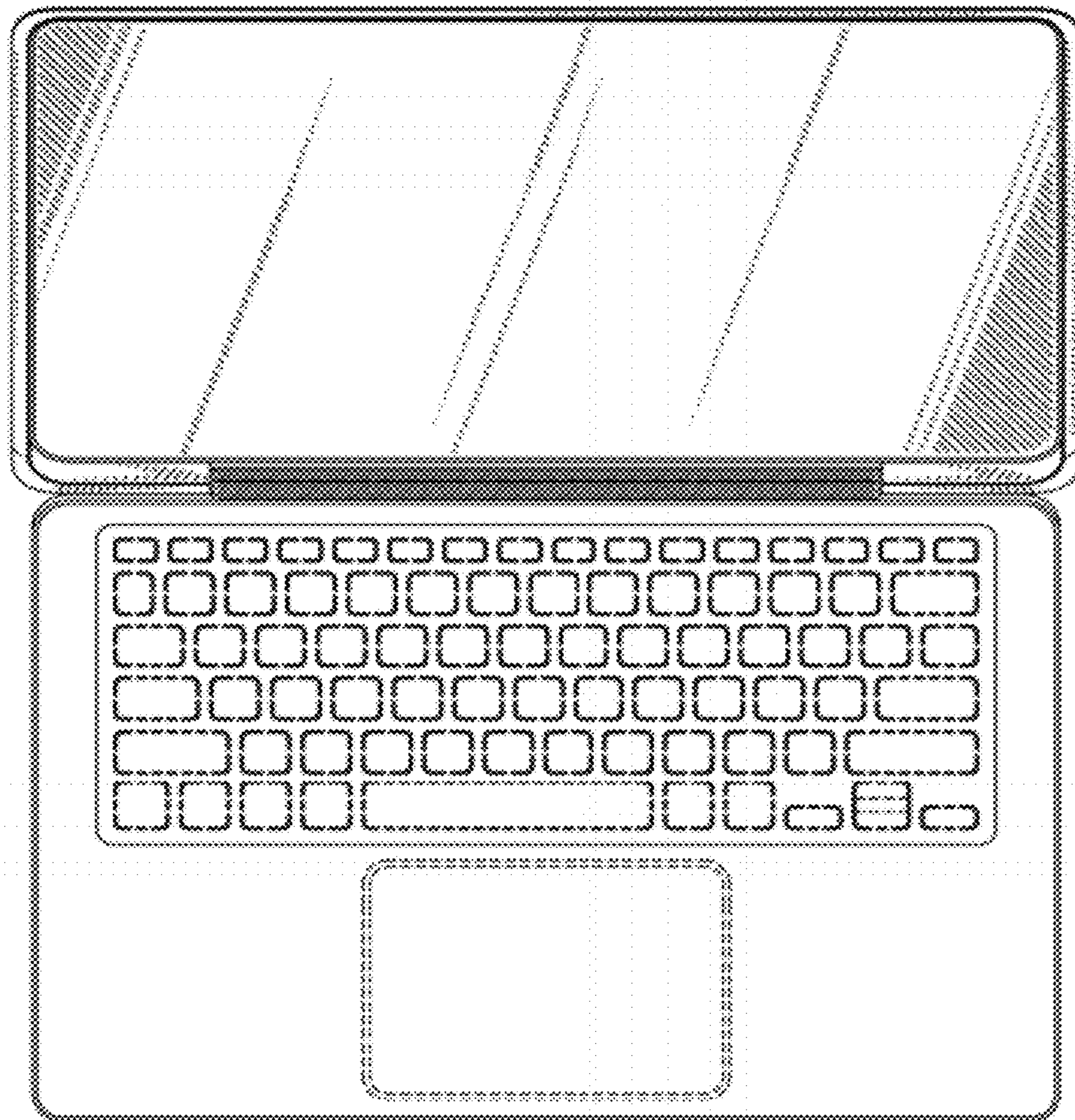

FIG. 9

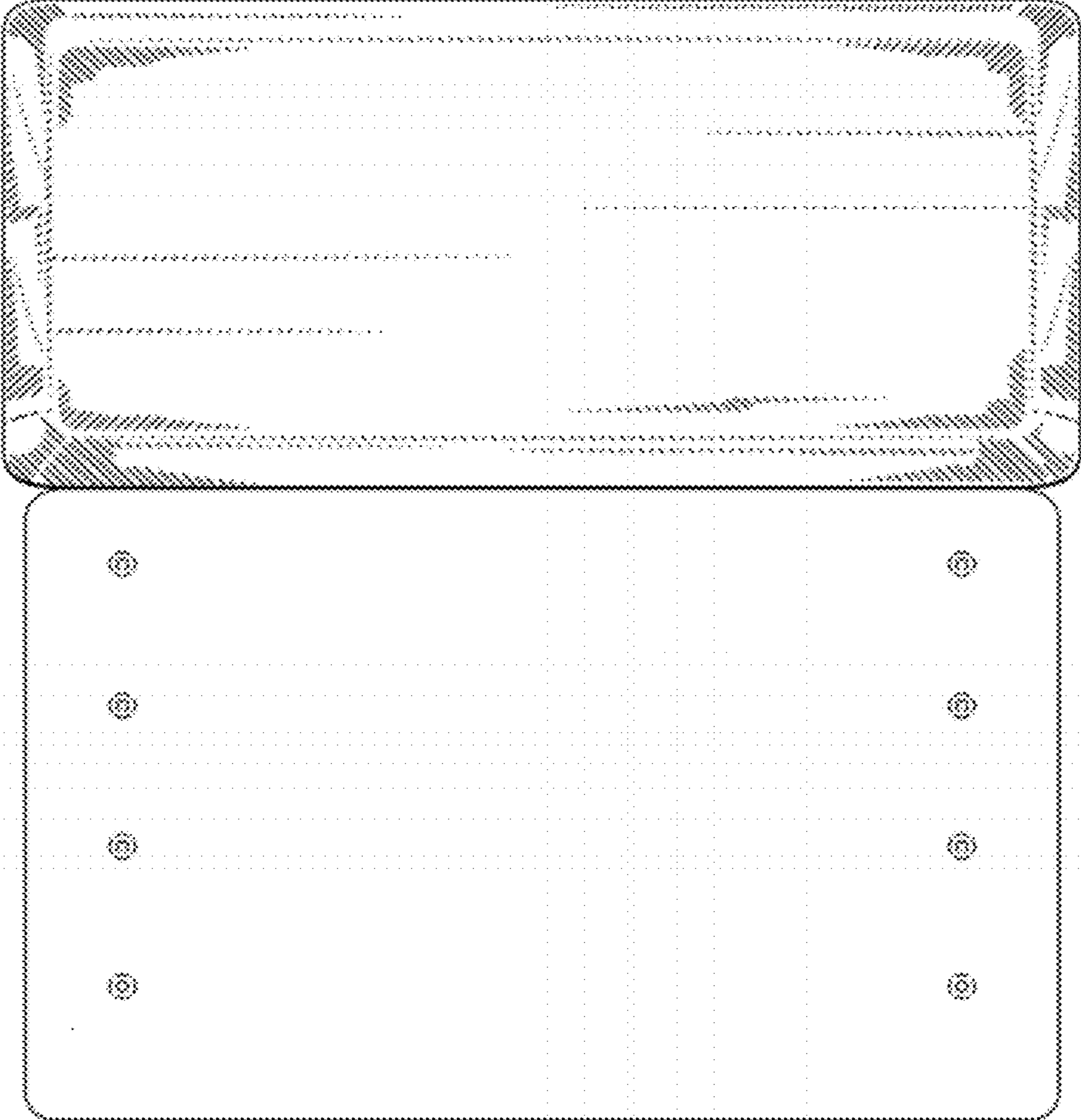

FIG. 10

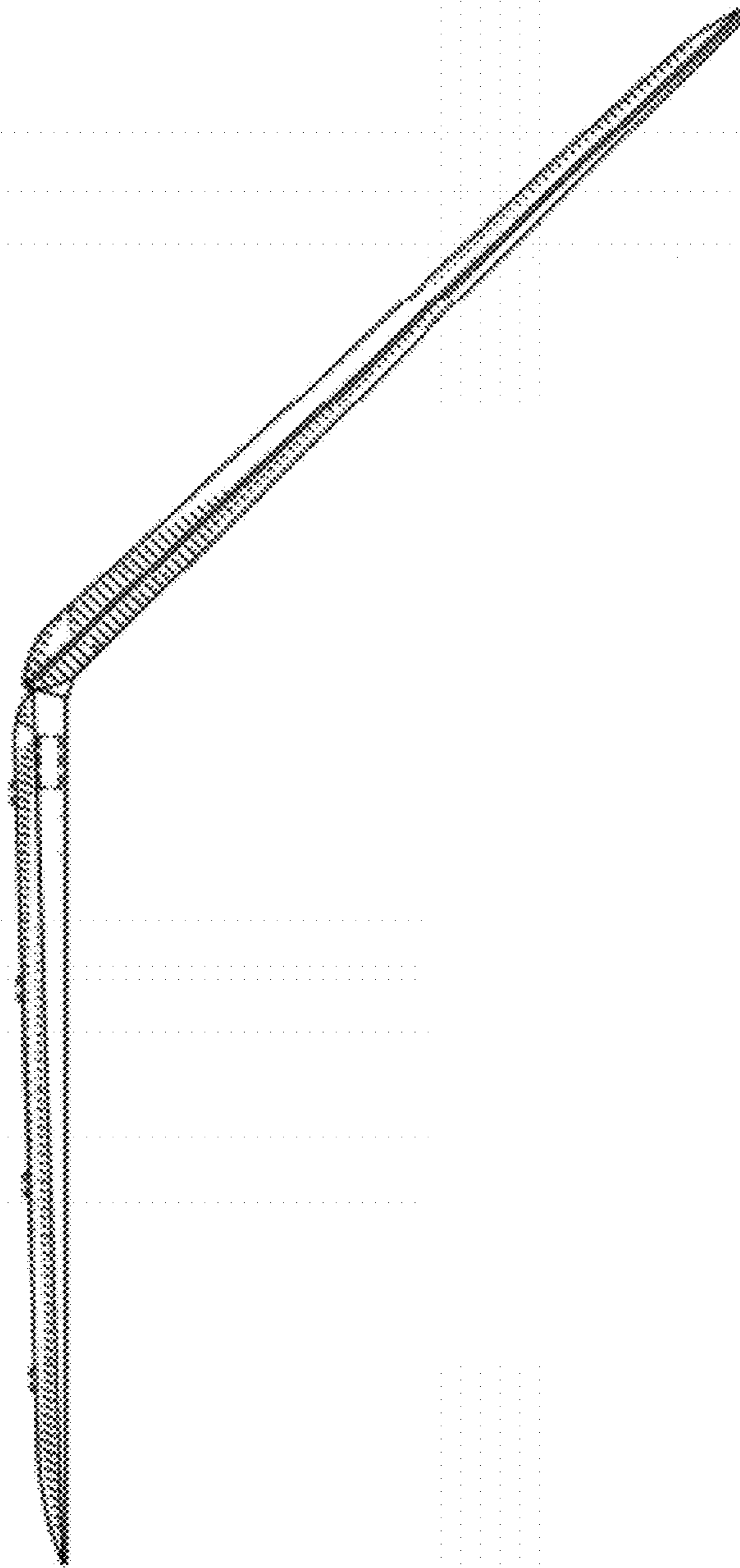

FIG. 11

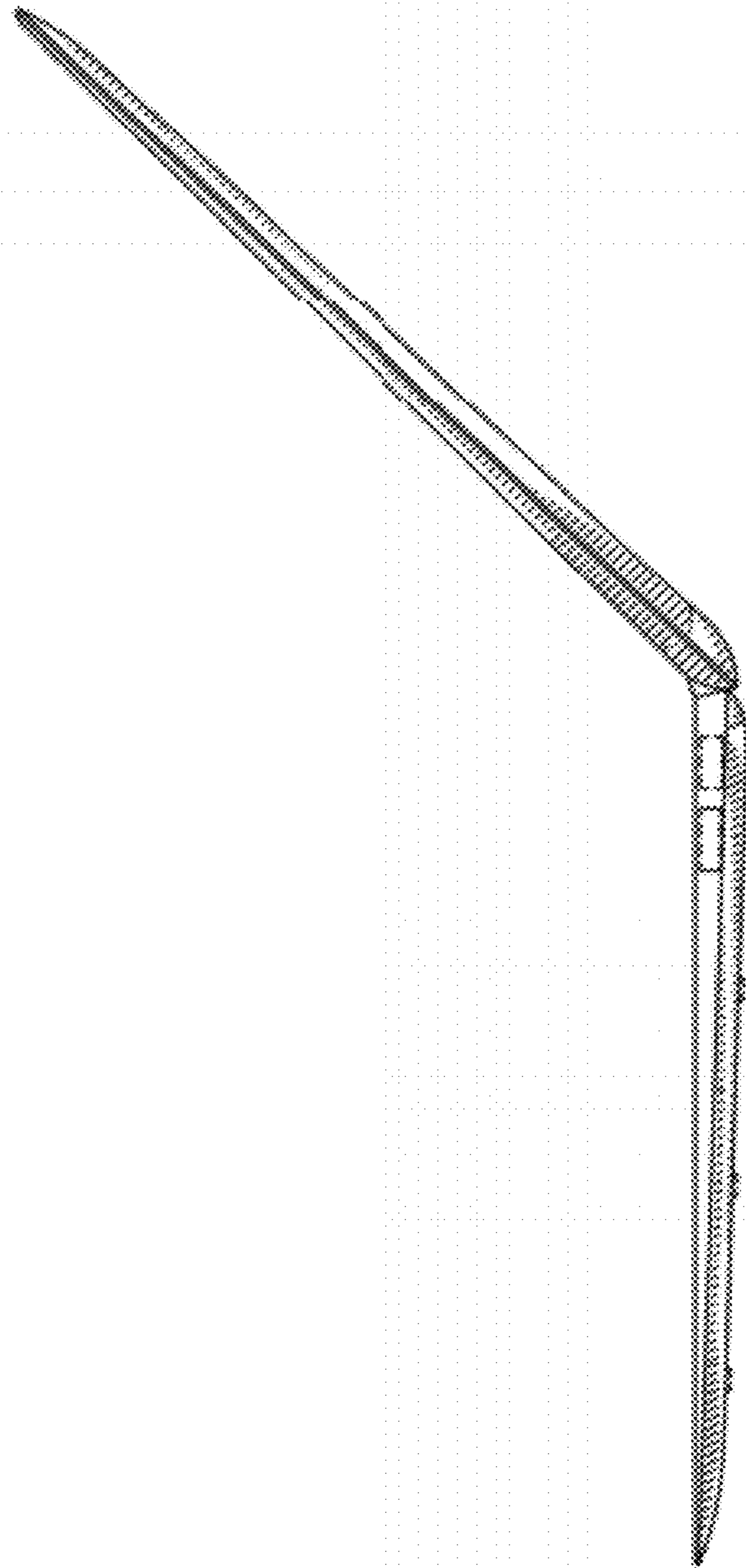

FIG. 12

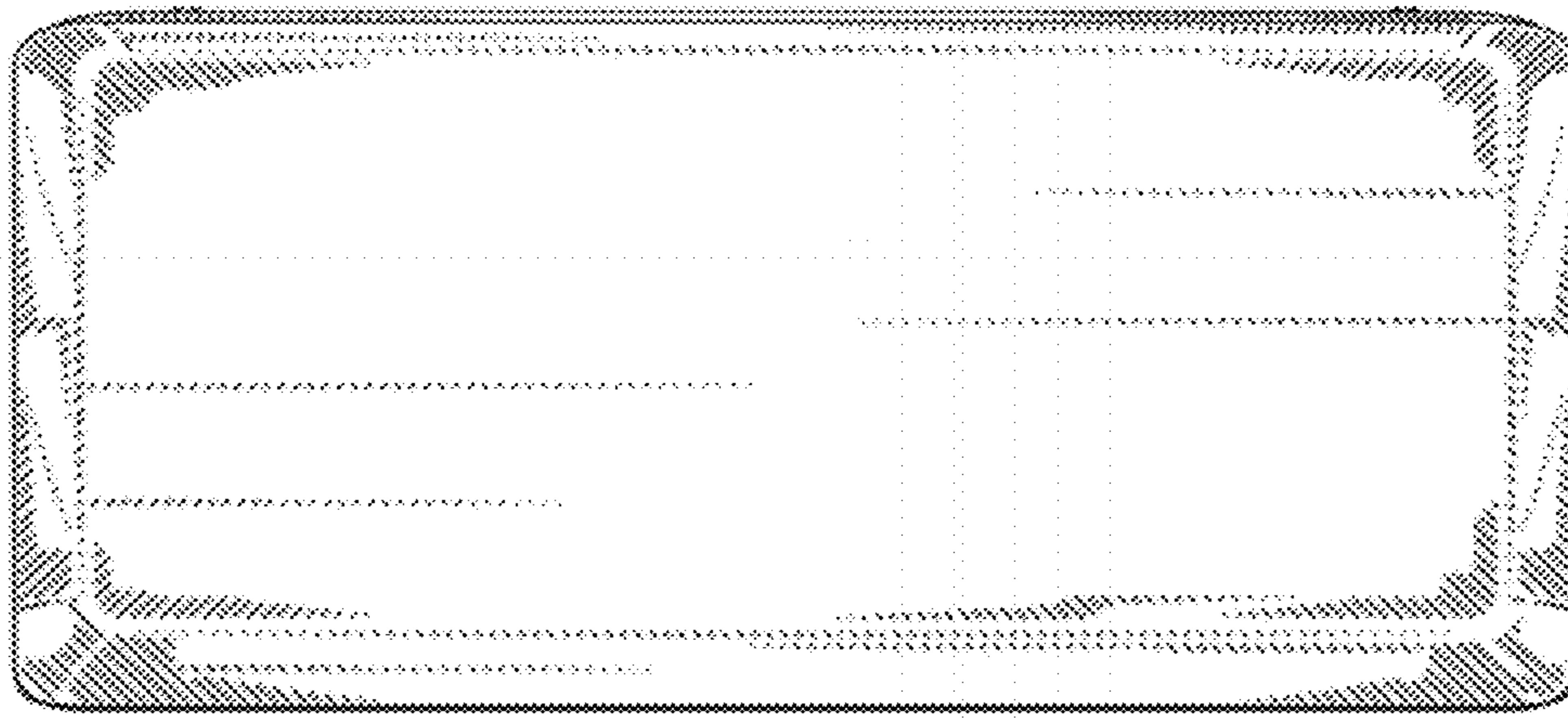

FIG. 13

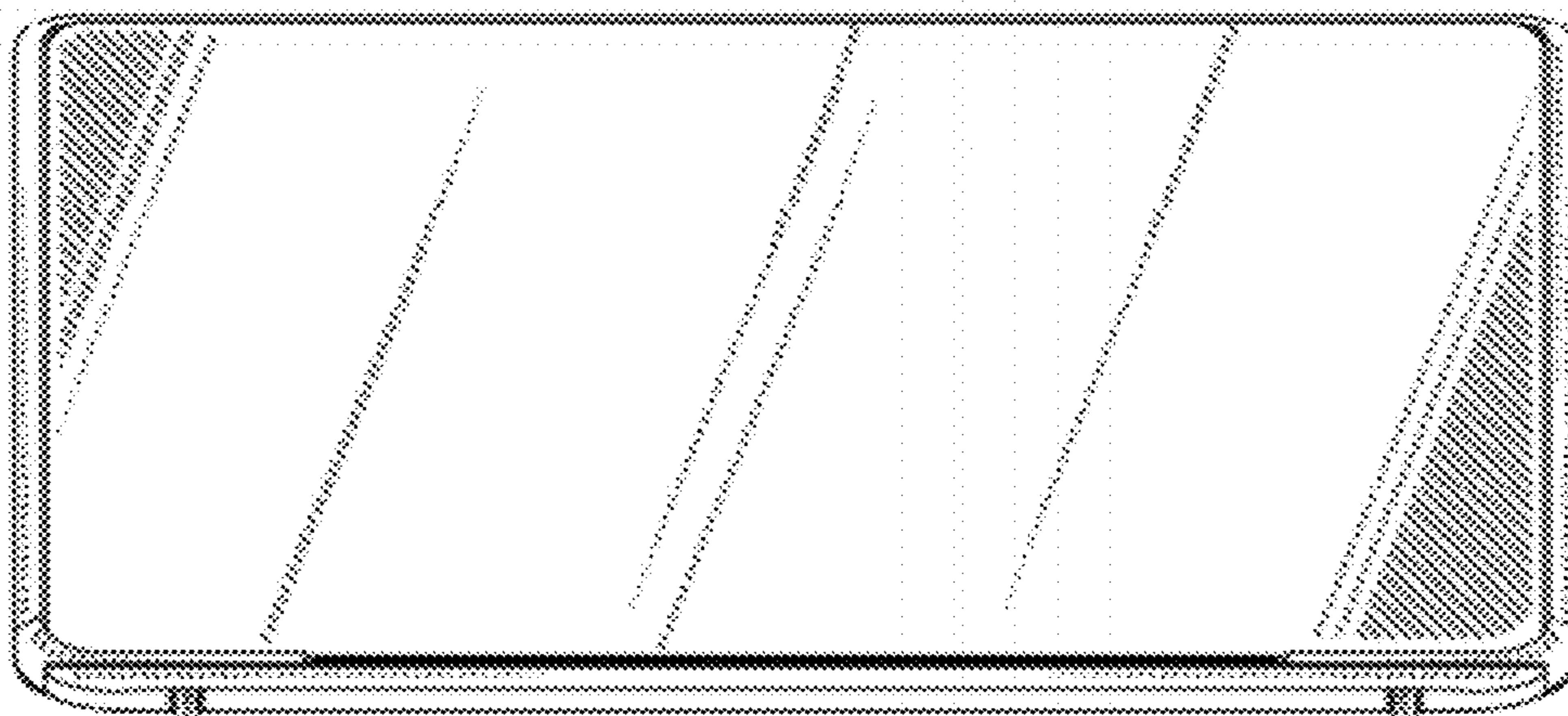

FIG. 14