



US00D675132S

(12) **United States Design Patent**
Colp

(10) **Patent No.:** **US D675,132 S**

(45) **Date of Patent:** **** Jan. 29, 2013**

(54) **FRONT FORK OF A BICYCLE**

(76) Inventor: **Joshua Colp**, Changhua County (TW)

(**) Term: **14 Years**

(21) Appl. No.: **29/425,746**

(22) Filed: **Jun. 27, 2012**

(51) **LOC (9) Cl.** **12-11**

(52) **U.S. Cl.** **D12/118**

(58) **Field of Classification Search** D12/118,
D12/111, 117; 280/274–279, 281.1, 288.1–288.3
See application file for complete search history.

(56) **References Cited**

U.S. PATENT DOCUMENTS

D26,520 S *	1/1897	Jenkins	D12/118
D340,434 S *	10/1993	Hammer et al.	D12/118
D494,108 S *	8/2004	Liao	D12/118

D521,420 S *	5/2006	Cobb	D12/118
7,175,191 B2 *	2/2007	Sinyard et al.	280/274
2011/0248469 A1 *	10/2011	Chubbuck et al.	280/276

* cited by examiner

Primary Examiner — Susan M Lee
Assistant Examiner — Linda G. Brooks

(57) **CLAIM**

The ornamental design for a front fork of a bicycle, as shown and described.

DESCRIPTION

FIG. 1 is a front perspective view of a front fork of a bicycle showing my new design;
FIG. 2 is a front elevational view thereof;
FIG. 3 is a rear elevational view thereof;
FIG. 4 is a left side view thereof;
FIG. 5 is a right side view thereof;
FIG. 6 is a top plan view thereof;
FIG. 7 is a bottom plan view thereof; and,
FIG. 8 is a rear perspective view thereof.

1 Claim, 7 Drawing Sheets

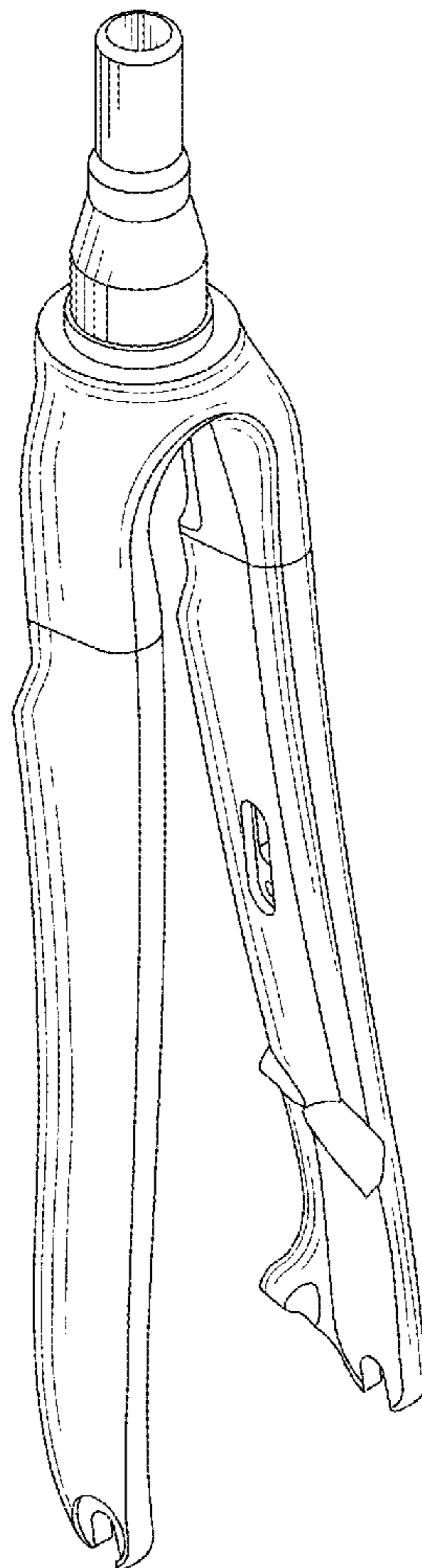

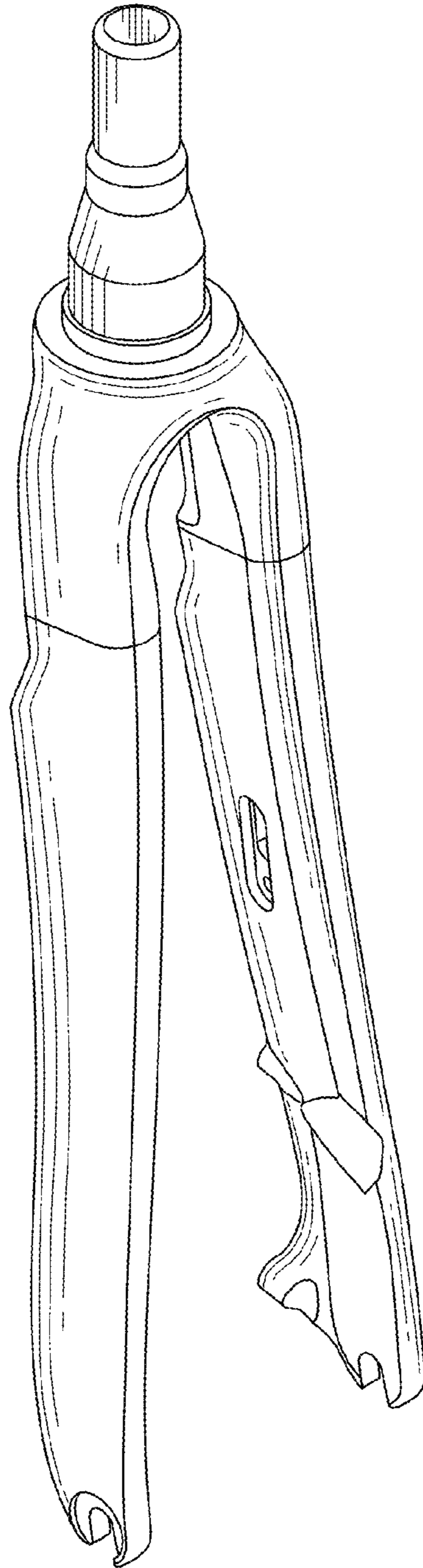

FIG. 1

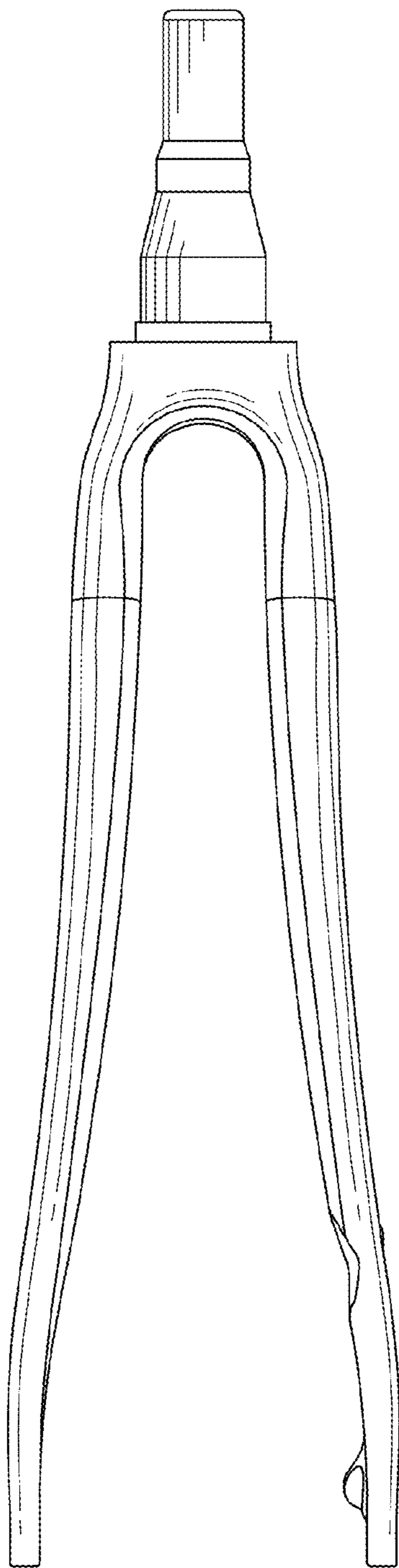

FIG. 2

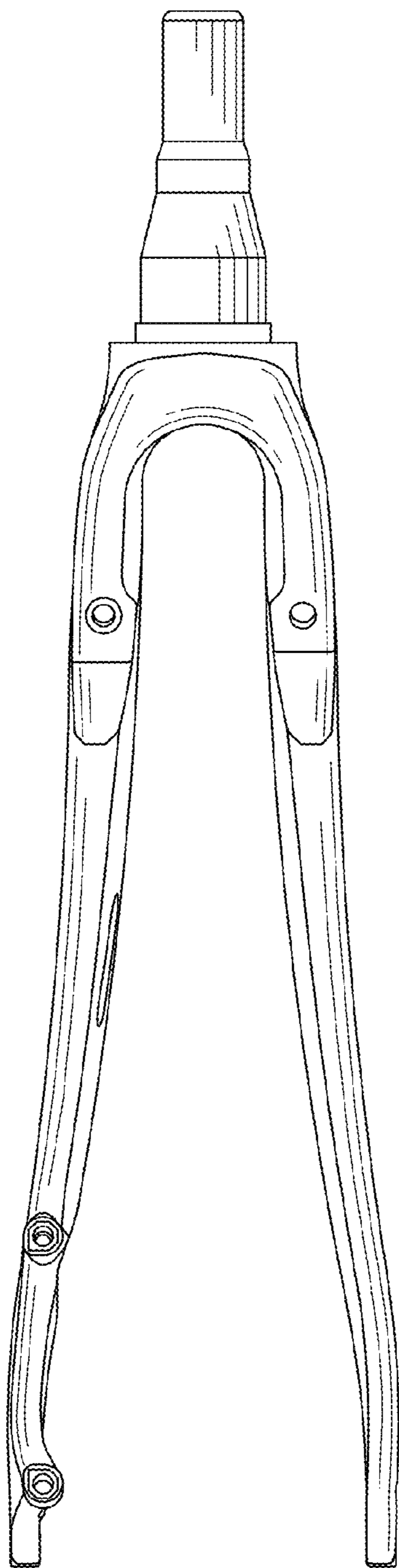

FIG. 3

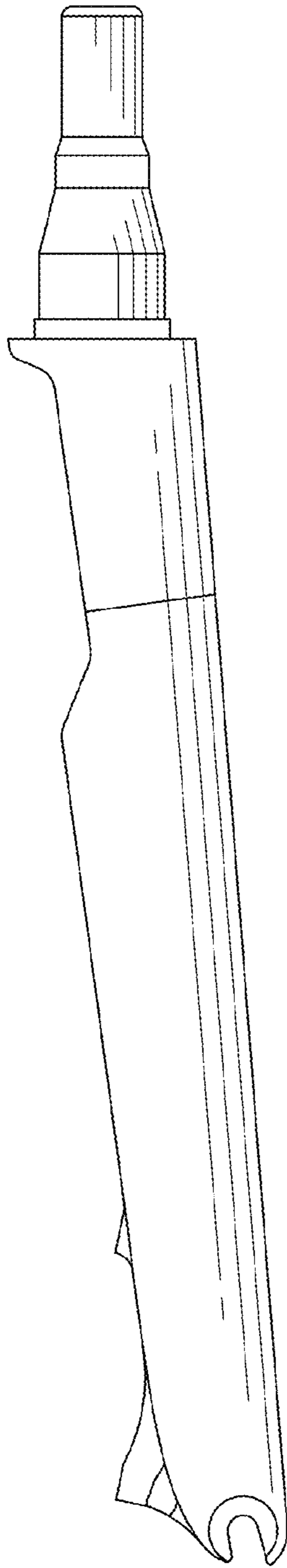

FIG. 4

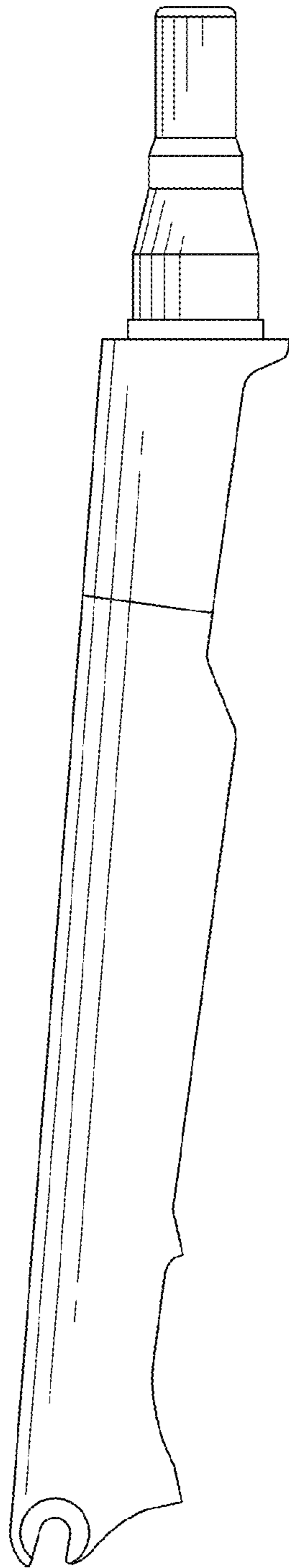

FIG. 5

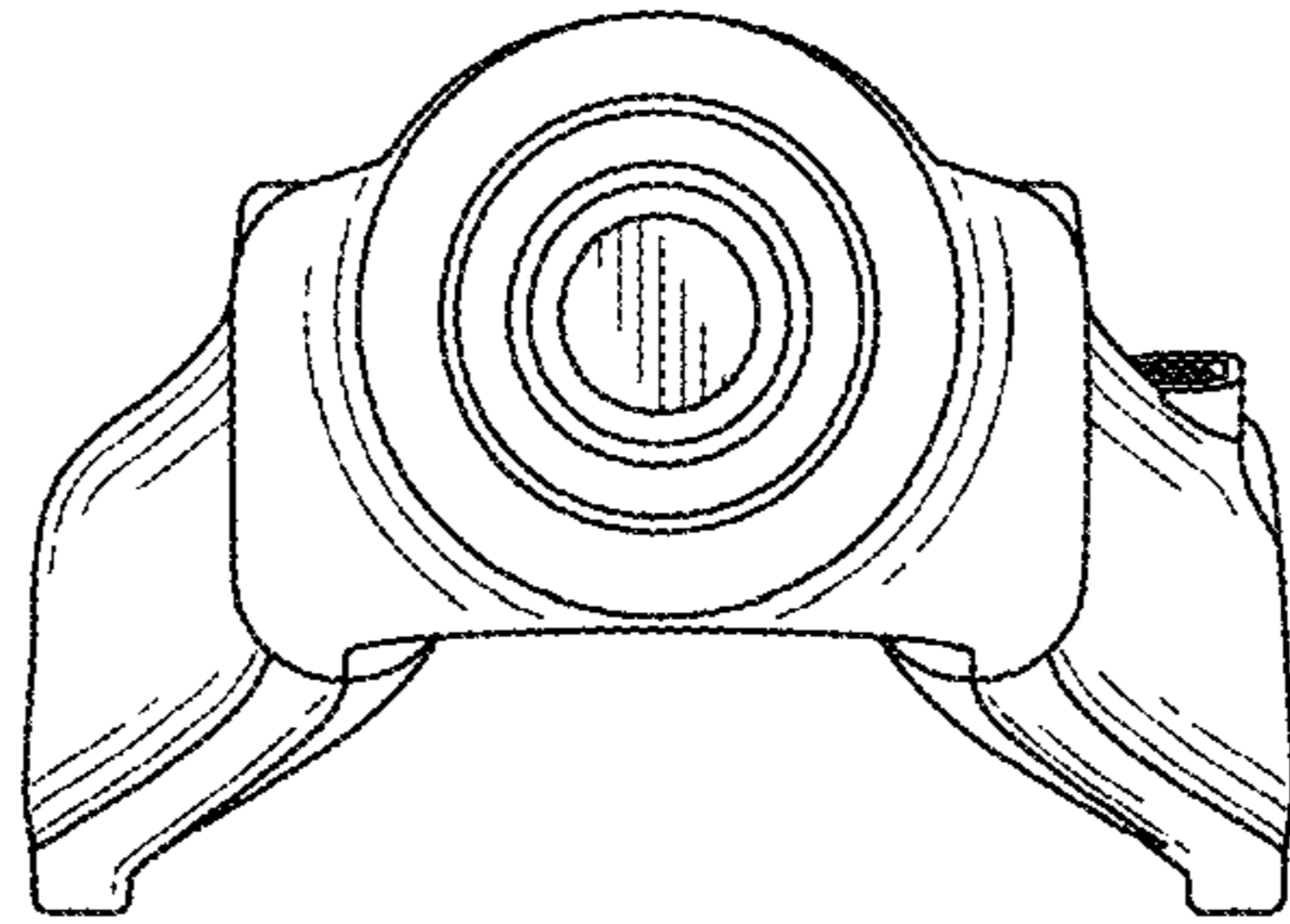

FIG. 6

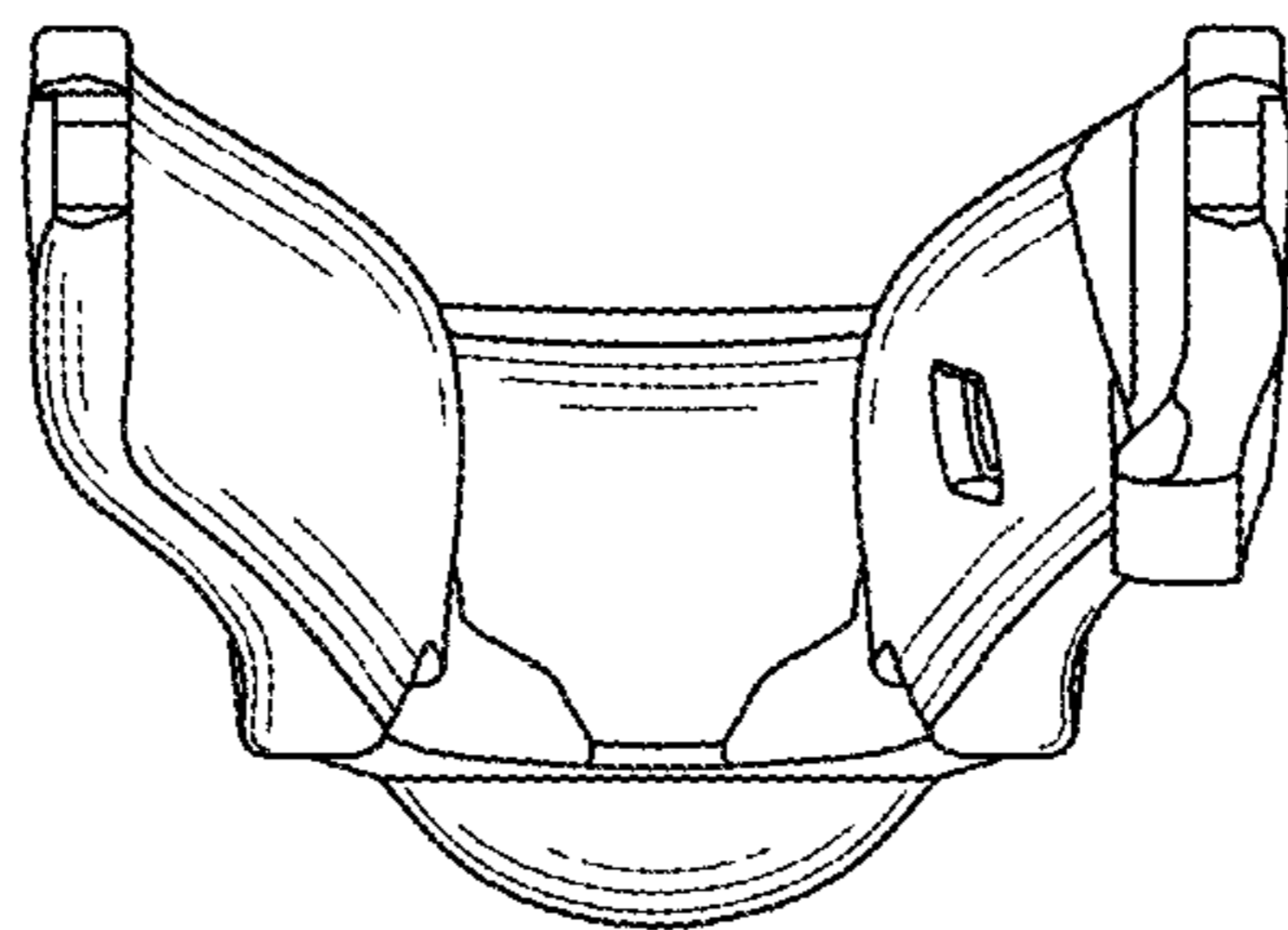

FIG. 7

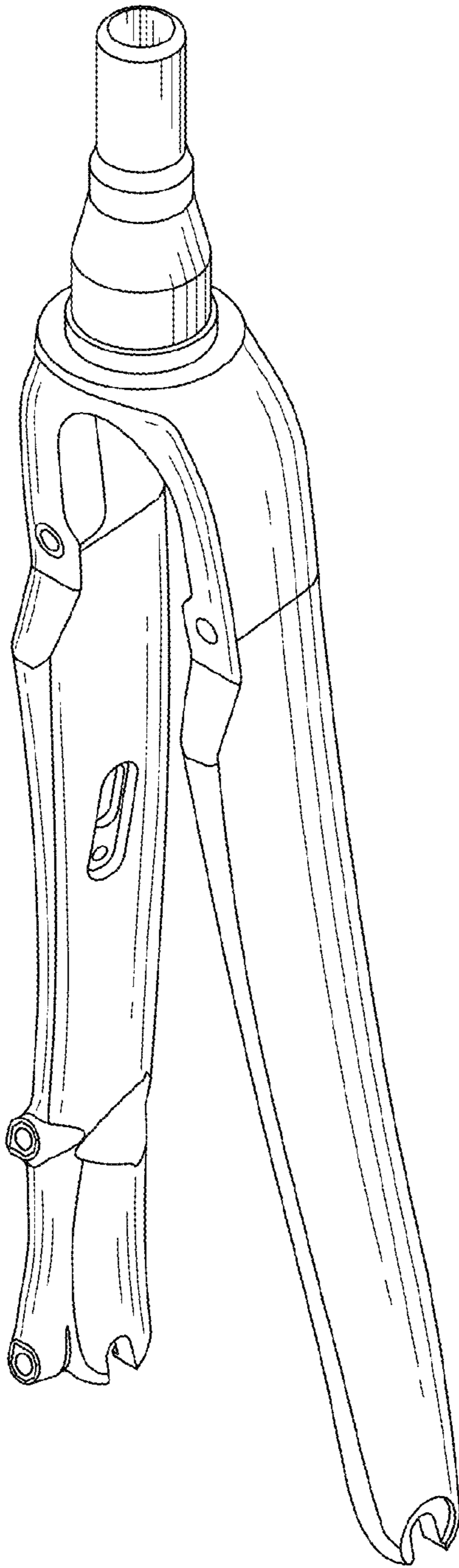

FIG. 8