



US00D675070S

(12) **United States Design Patent**  
**Rockwell**

(10) **Patent No.:** **US D675,070 S**  
(45) **Date of Patent:** **\*\* Jan. 29, 2013**

- (54) **ERGONOMIC SCOOP**
- (75) Inventor: **Lynn H. Rockwell**, Manitowoc, WI (US)
- (73) Assignee: **Manitowoc Foodservice Companies, LLC**, Manitowoc, WI (US)
- (\*\*) Term: **14 Years**
- (21) Appl. No.: **29/398,445**
- (22) Filed: **Jul. 29, 2011**
- (51) **LOC (9) Cl.** ..... **07-02**
- (52) **U.S. Cl.** ..... **D7/691**
- (58) **Field of Classification Search** ..... D7/368,  
D7/669, 681, 688, 690, 691, 692; D10/46.2,  
D10/46.3; D30/162; D21/472, 532; D8/10;  
294/176, 177, 180; 73/426-429; 30/324-328;  
15/257.1, 257.9  
See application file for complete search history.

D387,957	S	*	12/1997	Keller et al.	.....	D7/691
D387,958	S	*	12/1997	Keller et al.	.....	D7/691
5,706,546	A		1/1998	Utley		
5,716,087	A		2/1998	Backich et al.		
5,918,922	A		7/1999	Lathrop et al.		
D422,462	S	*	4/2000	Rivkin	.....	D7/691
6,412,842	B1		7/2002	Winston		
6,561,414	B1		5/2003	Cai		
6,863,520	B1		3/2005	Stiles		
7,621,572	B2		11/2009	Omdoll et al.		
D609,983	S	*	2/2010	Claypool et al.	.....	D7/691
7,673,769	B2		3/2010	McRorie, III		
D635,310	S	*	3/2011	Jessmon	.....	D30/162
D659,558	S	*	5/2012	Johnson et al.	.....	D10/46.2
2005/0151384	A1	*	7/2005	Omdoll et al.	.....	294/55
2005/0229438	A1		10/2005	Douziech		
2008/0136202	A1		6/2008	McRorie et al.		
2009/0140536	A1		6/2009	Claypool et al.		
2009/0167038	A1		7/2009	Claypool		

\* cited by examiner

*Primary Examiner* — Elizabeth J Oswecki

(74) *Attorney, Agent, or Firm* — Ohlandt, Greeley, Ruggiero & Perle, LLP

(56) **References Cited**

U.S. PATENT DOCUMENTS

132,134	A	*	10/1872	Bowers	.....	294/176
1,435,061	A		11/1922	Halsey		
D216,138	S	*	11/1969	Carinigan	.....	D21/721
3,490,501	A	*	1/1970	Lefebvre et al.	.....	141/84
3,802,729	A		4/1974	Akre		
3,840,261	A		10/1974	Fulkerson et al.		
4,126,346	A		11/1978	Burns		
4,149,745	A		4/1979	Willis		
D254,832	S	*	4/1980	Zappa	.....	D7/691
4,290,198	A		9/1981	Richards		
4,458,960	A		7/1984	Dunst		
D296,406	S	*	6/1988	Fuller	.....	D7/691
4,788,862	A		12/1988	Fuller		
D318,350	S	*	7/1991	Muffuletto	.....	D32/35
5,092,050	A		3/1992	Bardeen		
5,613,660	A		3/1997	Wyatt		
5,660,421	A		8/1997	Krenzler		

(57) **CLAIM**

The ornamental design for ergonomic scoop, as shown and described.

**DESCRIPTION**

FIG. 1 is a top, front and right side perspective view of an ergonomic scoop showing my new design;  
FIG. 2 is a left side view thereof, the right side view being a mirror image thereof;  
FIG. 3 is a top view thereof;  
FIG. 4 is a bottom view thereof;  
FIG. 5 is a front view thereof; and,  
FIG. 6 is a rear view thereof.

**1 Claim, 6 Drawing Sheets**

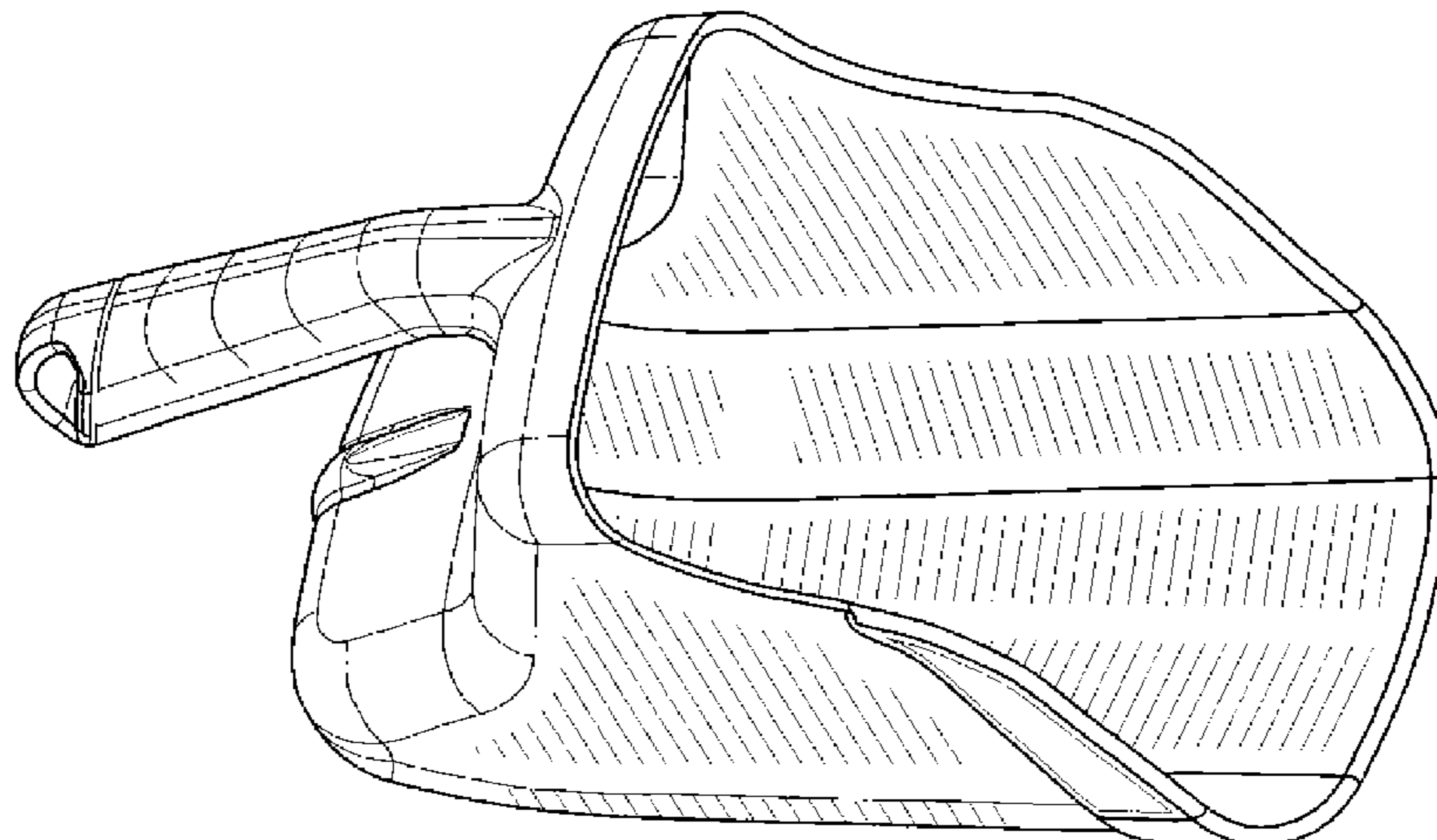

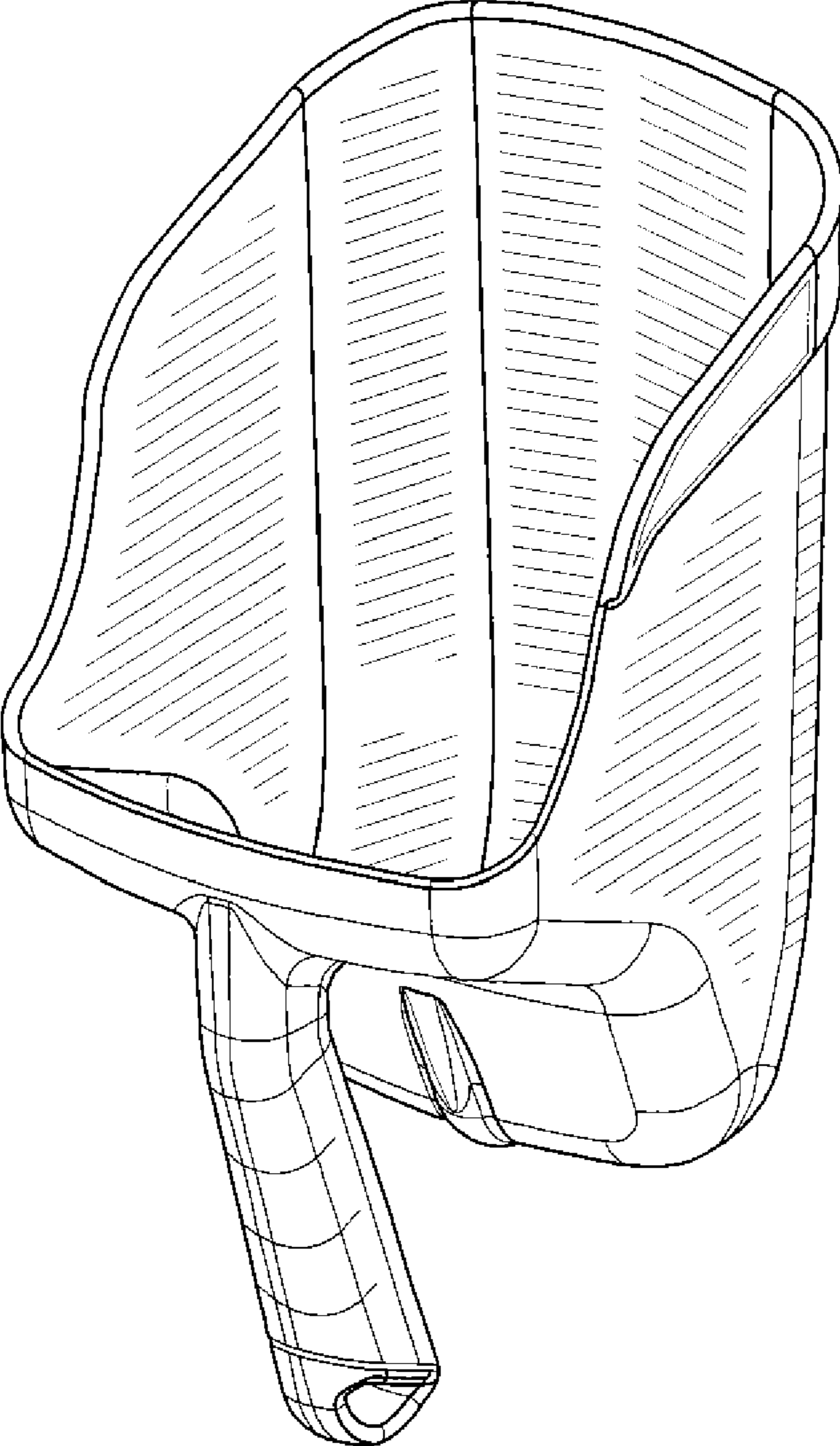

FIG. 1

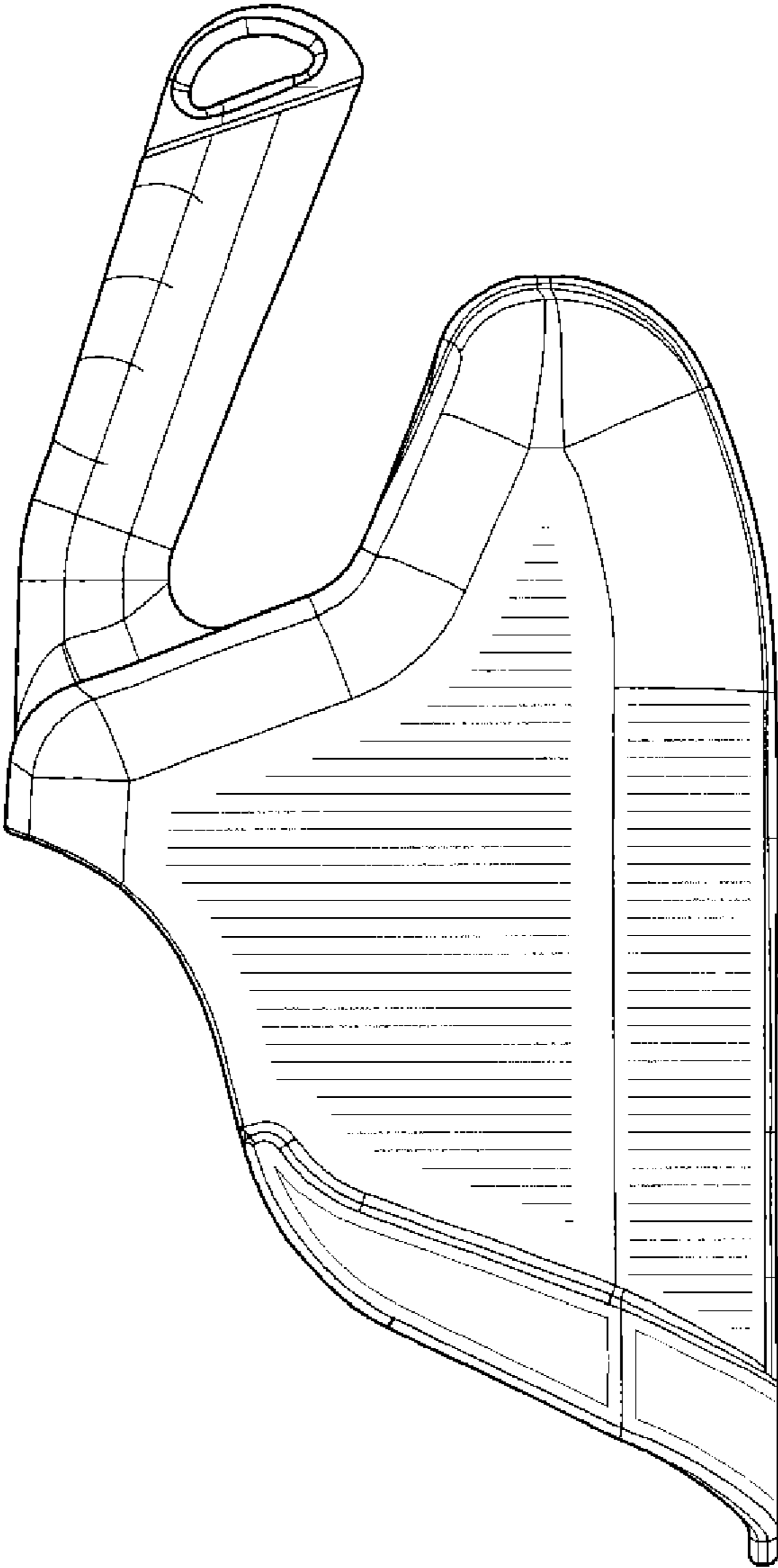

FIG. 2

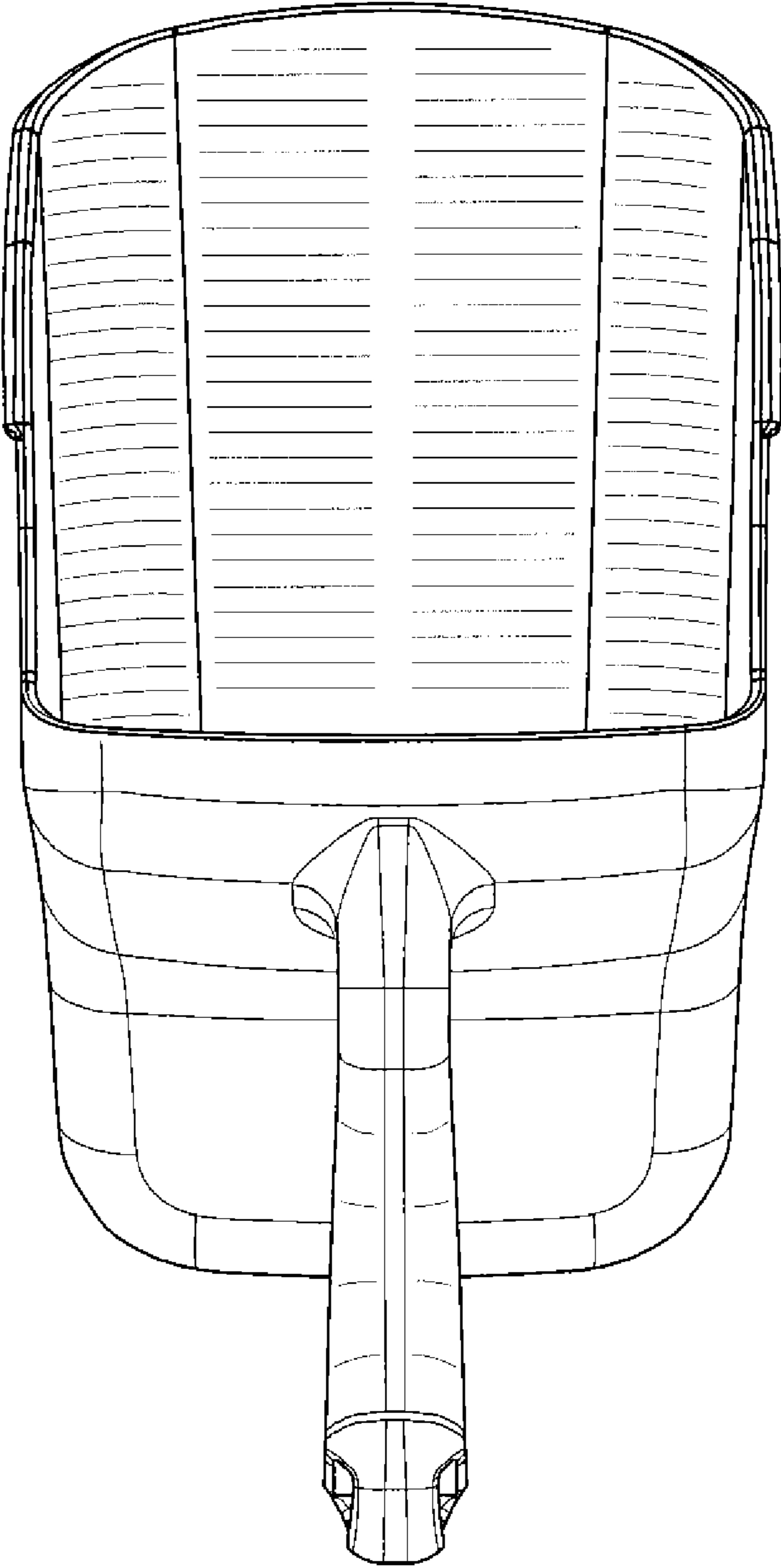

FIG. 3

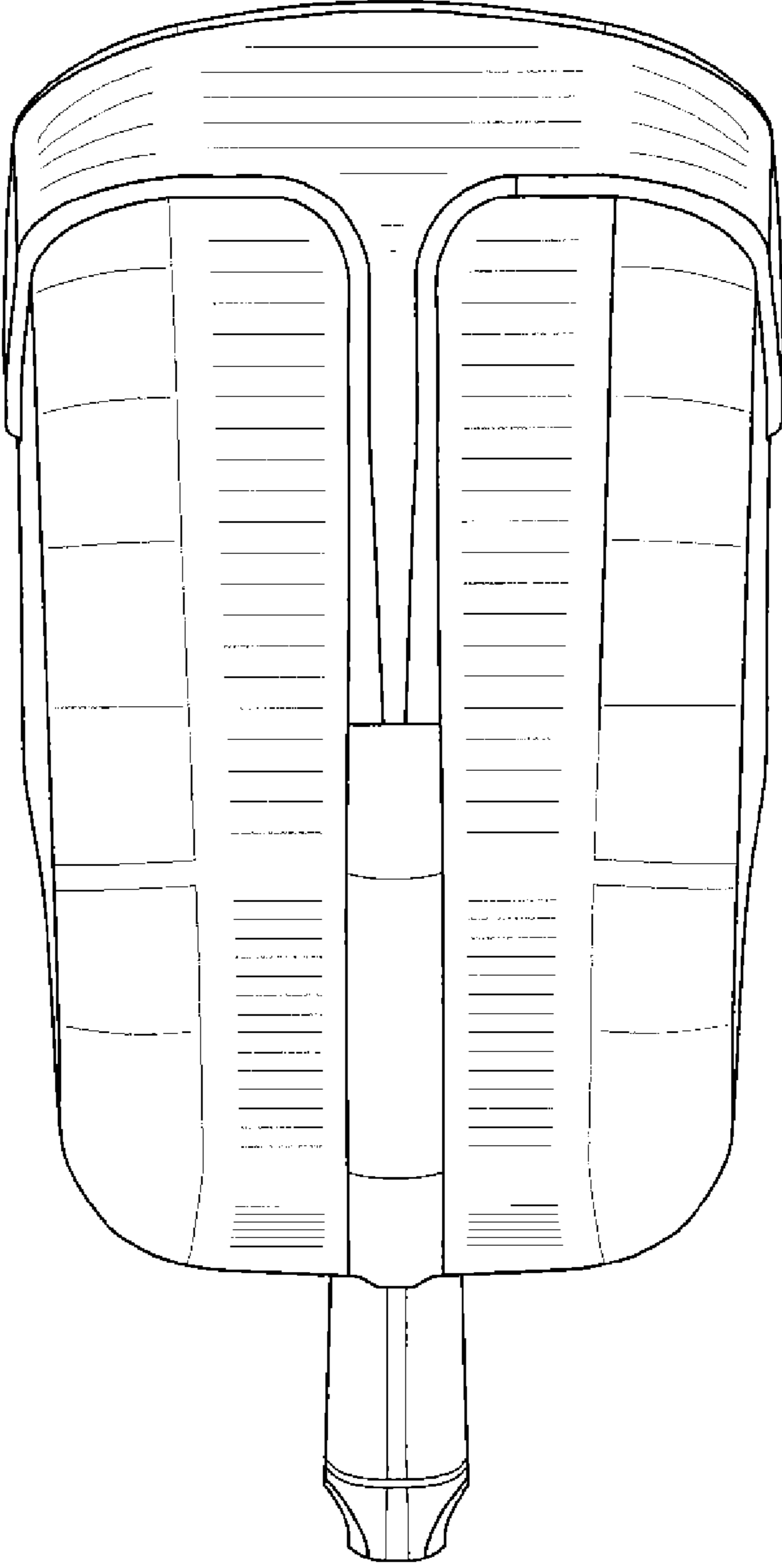

FIG. 4

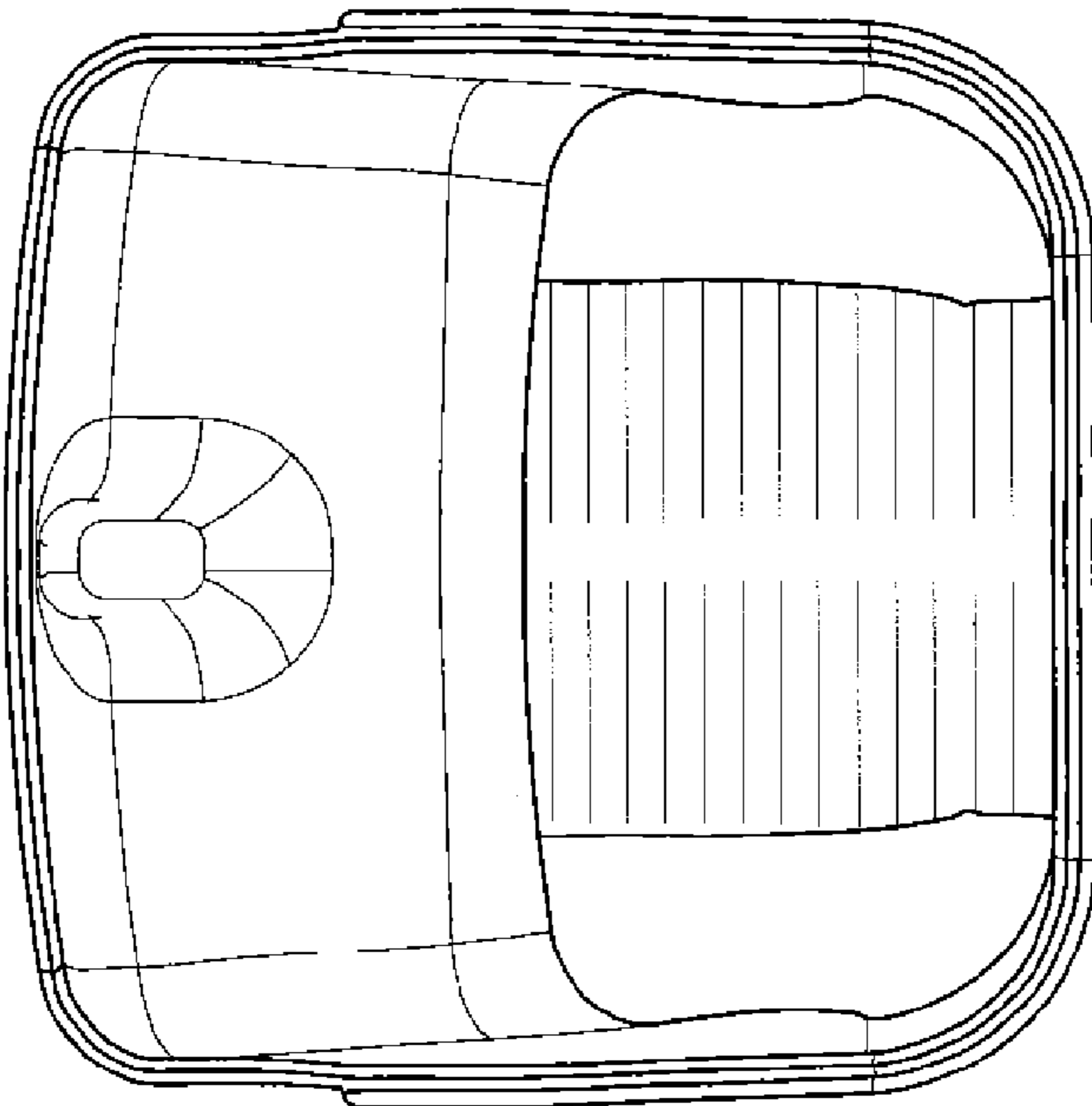

FIG. 5

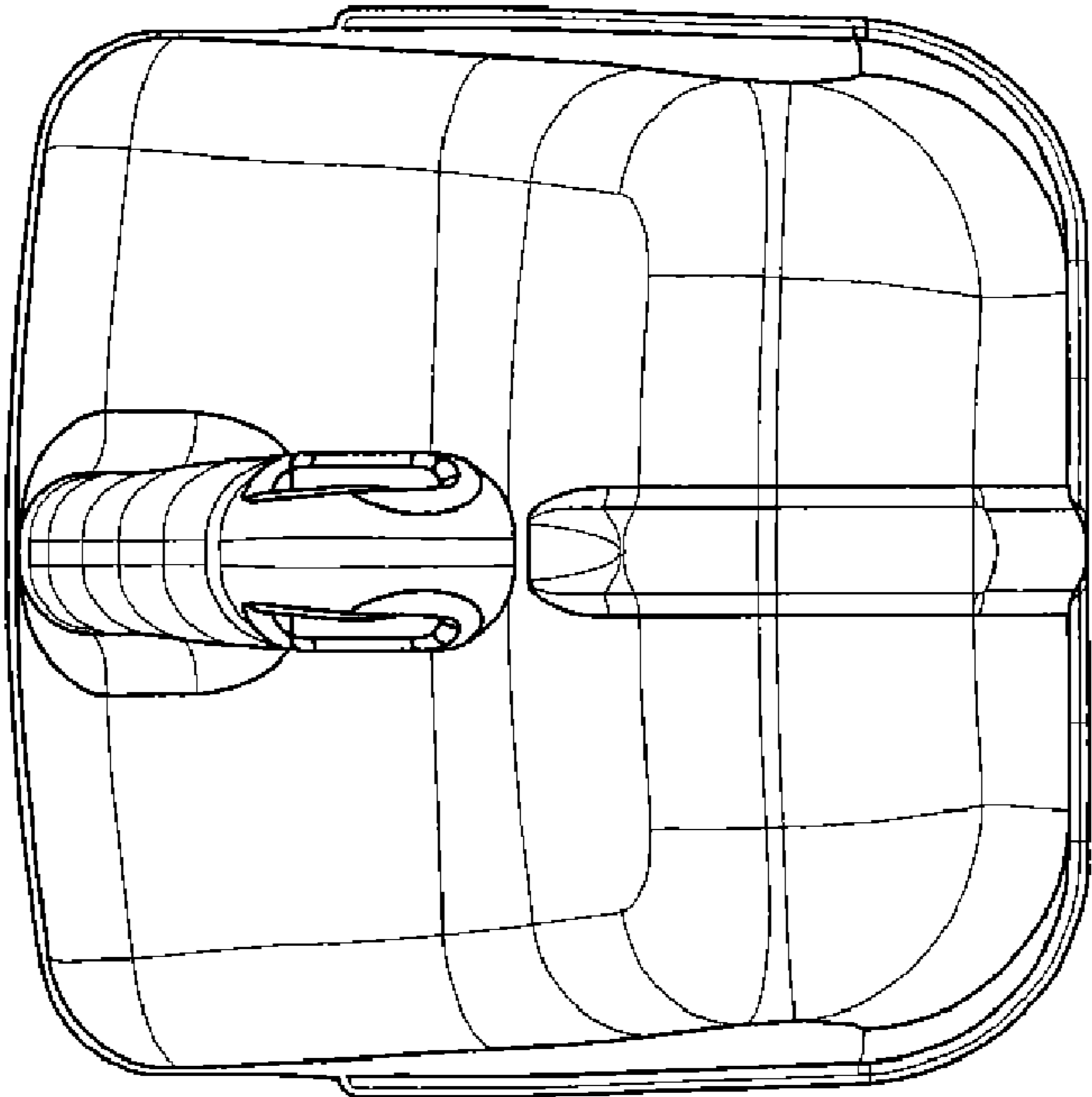

FIG. 6