



US00D674979S

(12) **United States Design Patent**
Girardot et al.

(10) **Patent No.:** **US D674,979 S**
(45) **Date of Patent:** **** Jan. 22, 2013**

(54) **TELESCOPING HANDLE**

(75) Inventors: **Richard Michael Girardot**, West Chester, OH (US); **David William Schuller**, Lebanon, OH (US); **Richard Christopher Hagee**, Columbus, OH (US); **Ryan Robert Berger**, Columbus, OH (US); **Diana Woehnl Juratovac**, Columbus, OH (US); **Rainer Bernhard Teufel**, Worthington, OH (US)

(73) Assignee: **The Procter & Gamble Company**, Cincinnati, OH (US)

(**) Term: **14 Years**

(21) Appl. No.: **29/367,666**

(22) Filed: **Aug. 11, 2010**

(51) **LOC (9) Cl.** **08-99**

(52) **U.S. Cl.** **D32/35**

(58) **Field of Classification Search** D4/132, D4/138; D8/80, 94, 97; 15/143.1, 208, 209.1, 15/210.1, 211, 234-235, 244.1-244.3, 229.13, 15/106, 146, 147.1, 164

See application file for complete search history.

(56) **References Cited**

U.S. PATENT DOCUMENTS

1,195,190	A	8/1916	Dunlap	
2,262,888	A	11/1941	Dodge	
4,010,511	A	3/1977	Komatsu	
D572,873	S *	7/2008	Hoadley et al.	D32/52
D579,614	S *	10/2008	Tanaka et al.	D32/52
D579,615	S *	10/2008	Ames et al.	D32/52
D600,421	S *	9/2009	Hoadley et al.	D32/52
7,650,664	B2 *	1/2010	Henderson et al.	15/210.1
D614,824	S *	4/2010	Heidel et al.	D32/52
7,716,777	B2 *	5/2010	Lee	15/229.3
7,739,770	B2 *	6/2010	Tanaka et al.	15/228
7,740,412	B2 *	6/2010	Hoadley et al.	401/134
7,891,898	B2 *	2/2011	Hoadley et al.	401/123
7,976,235	B2 *	7/2011	Hoadley et al.	401/138
8,156,603	B2 *	4/2012	Tsutanaga et al.	15/229.3
2004/0034956	A1 *	2/2004	Tanaka et al.	15/229.4
2005/0172440	A1 *	8/2005	Lin	15/226

2006/0130260	A1 *	6/2006	Lee	15/226
2006/0137116	A1 *	6/2006	Tsuchiya et al.	15/1.52
2006/0200930	A1 *	9/2006	Chin	15/226
2006/0230567	A1 *	10/2006	Harper et al.	15/228
2006/0260082	A1	11/2006	Bonilla	
2007/0180640	A1 *	8/2007	Knopow et al.	15/210.1
2007/0212157	A1 *	9/2007	Hoadley et al.	401/136
2008/0235891	A1 *	10/2008	Tsuchiya et al.	15/209.1

* cited by examiner

Primary Examiner — Eric Goodman

(74) *Attorney, Agent, or Firm* — Larry L. Huston; Steven W. Miller

(57) **CLAIM**

The ornamental design for a telescoping handle, as shown and described.

DESCRIPTION

FIG. 1 is a perspective view of an extended handle showing our new design:

FIG. 2 is a right side view thereof;

FIG. 3 is left side view thereof;

FIG. 4 is a top view thereof;

FIG. 5 is a bottom view thereof;

FIG. 6 is a rear view thereof; and

FIG. 7 is a front view thereof.

FIG. 8 is a perspective view of a collapsed handle showing our new design and having the fork tines extended;

FIG. 9 is a right side view thereof;

FIG. 10 is left side view thereof;

FIG. 11 is a top view thereof;

FIG. 12 is a bottom view thereof;

FIG. 13 is a rear view thereof; and

FIG. 14 is a front view thereof.

FIG. 15 is a perspective view of a collapsed handle showing our new design and having the fork tines folded back;

FIG. 16 is a right side view thereof;

FIG. 17 is left side view thereof;

FIG. 18 is a top view thereof;

FIG. 19 is a bottom view thereof;

FIG. 20 is a rear view thereof; and,

FIG. 21 is a front view thereof.

The broken lines shown in the drawings are for illustrative purposes only and form no part of the claimed design.

1 Claim, 9 Drawing Sheets

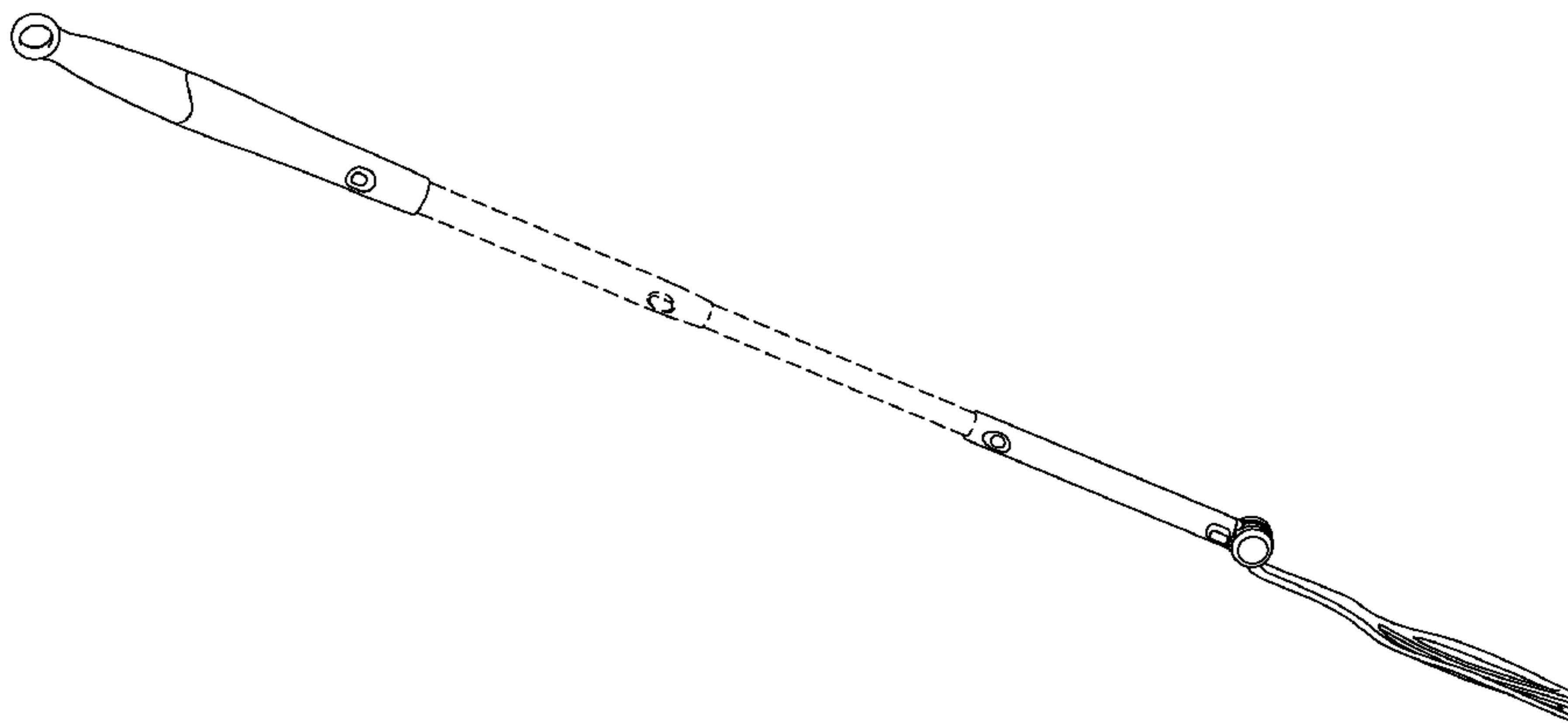

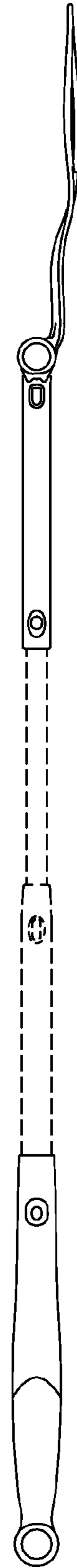
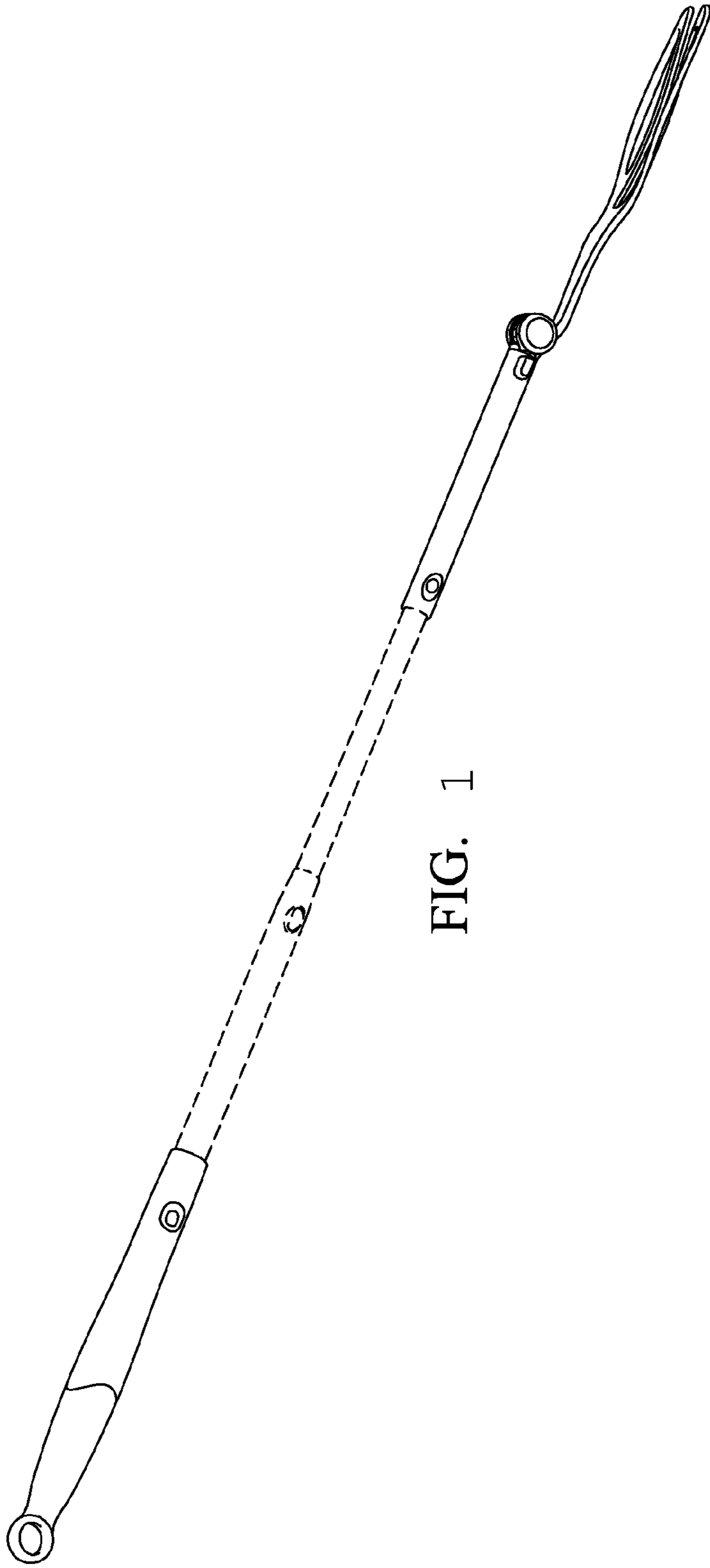

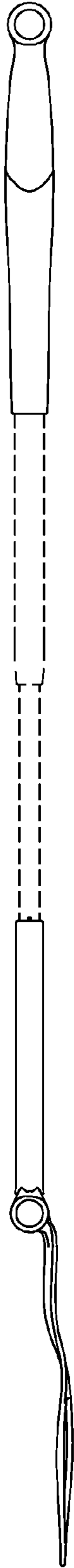

FIG. 3

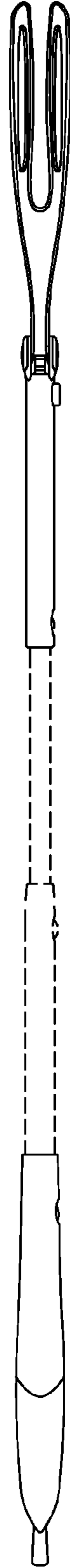

FIG. 4

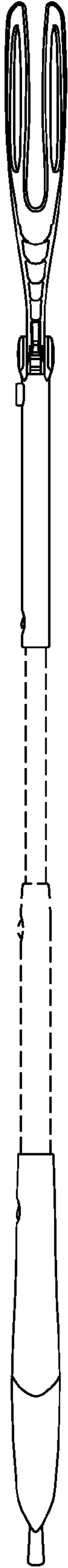

FIG. 5

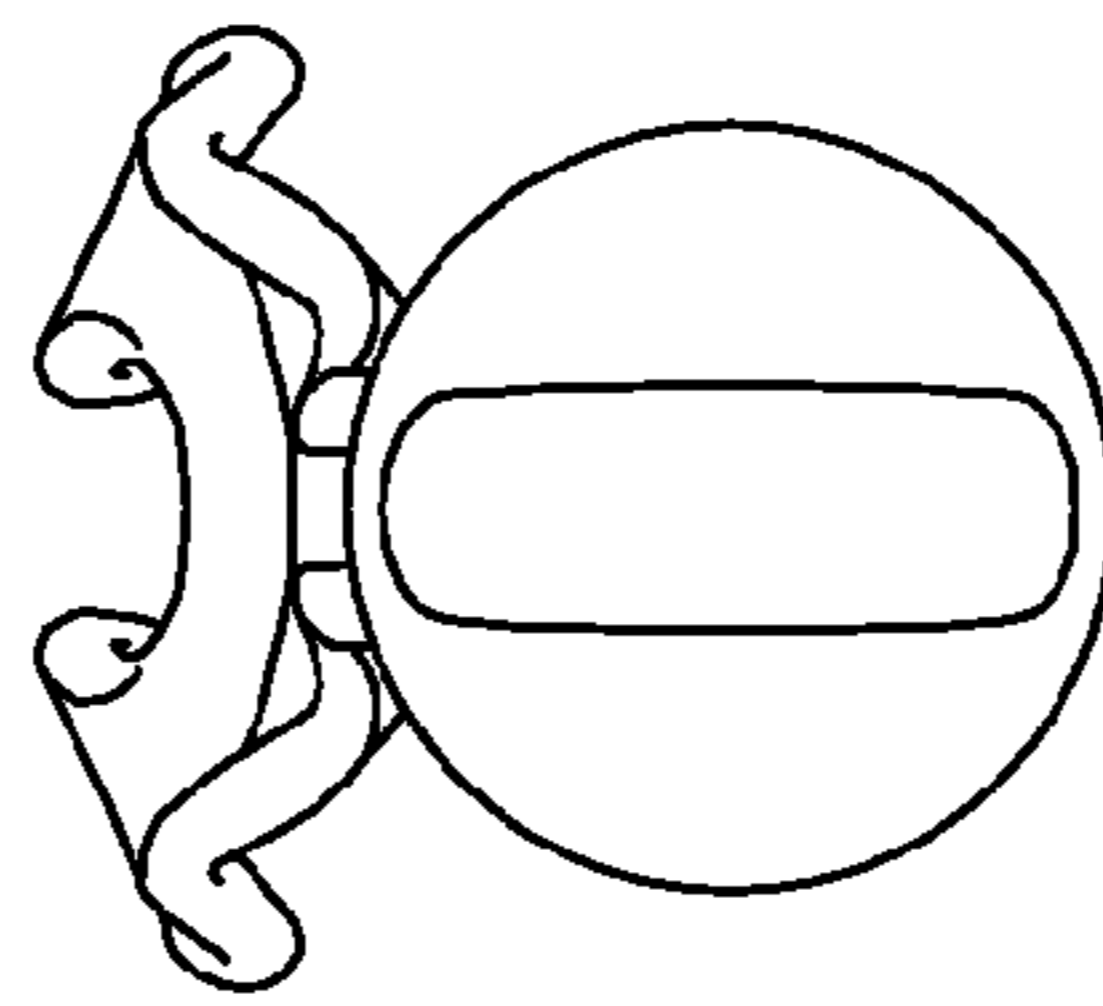

FIG. 6

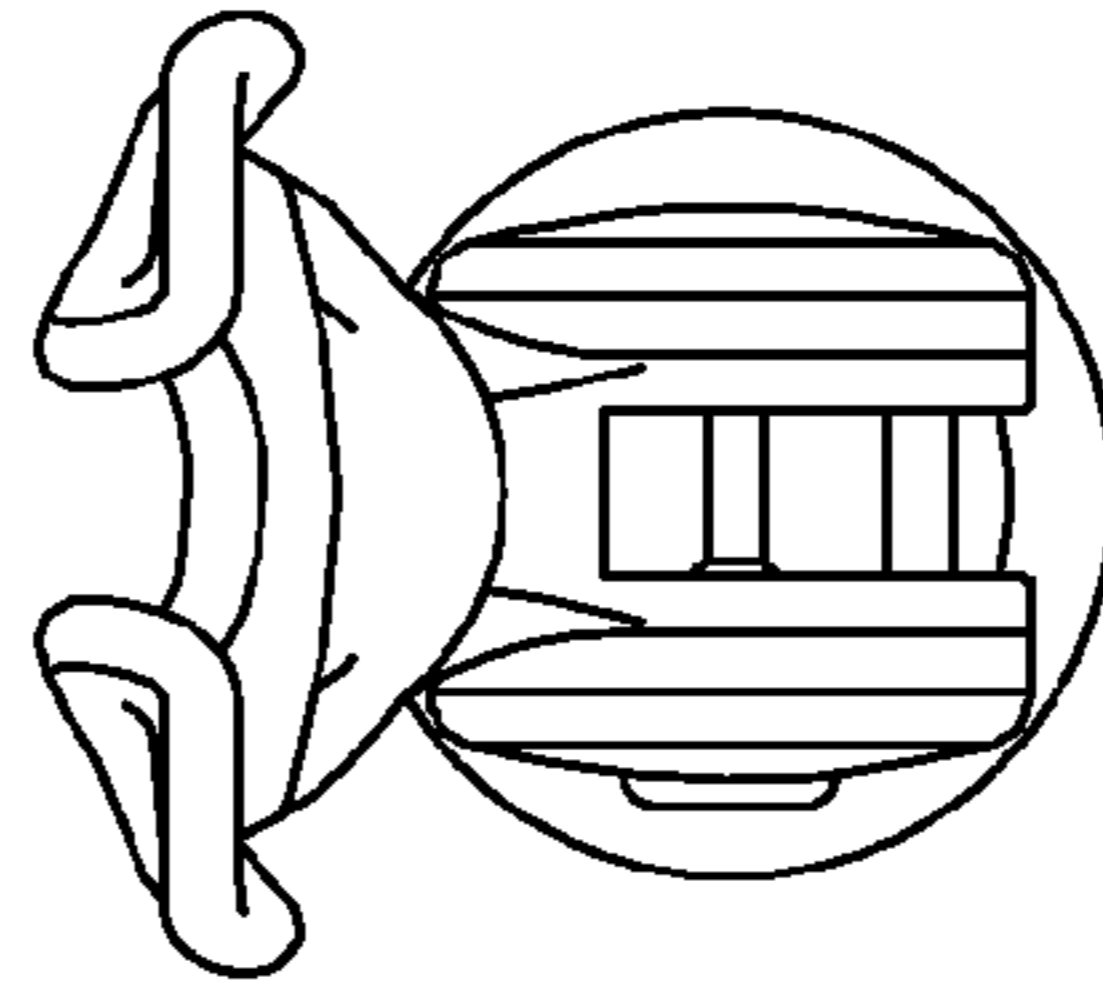

FIG. 7

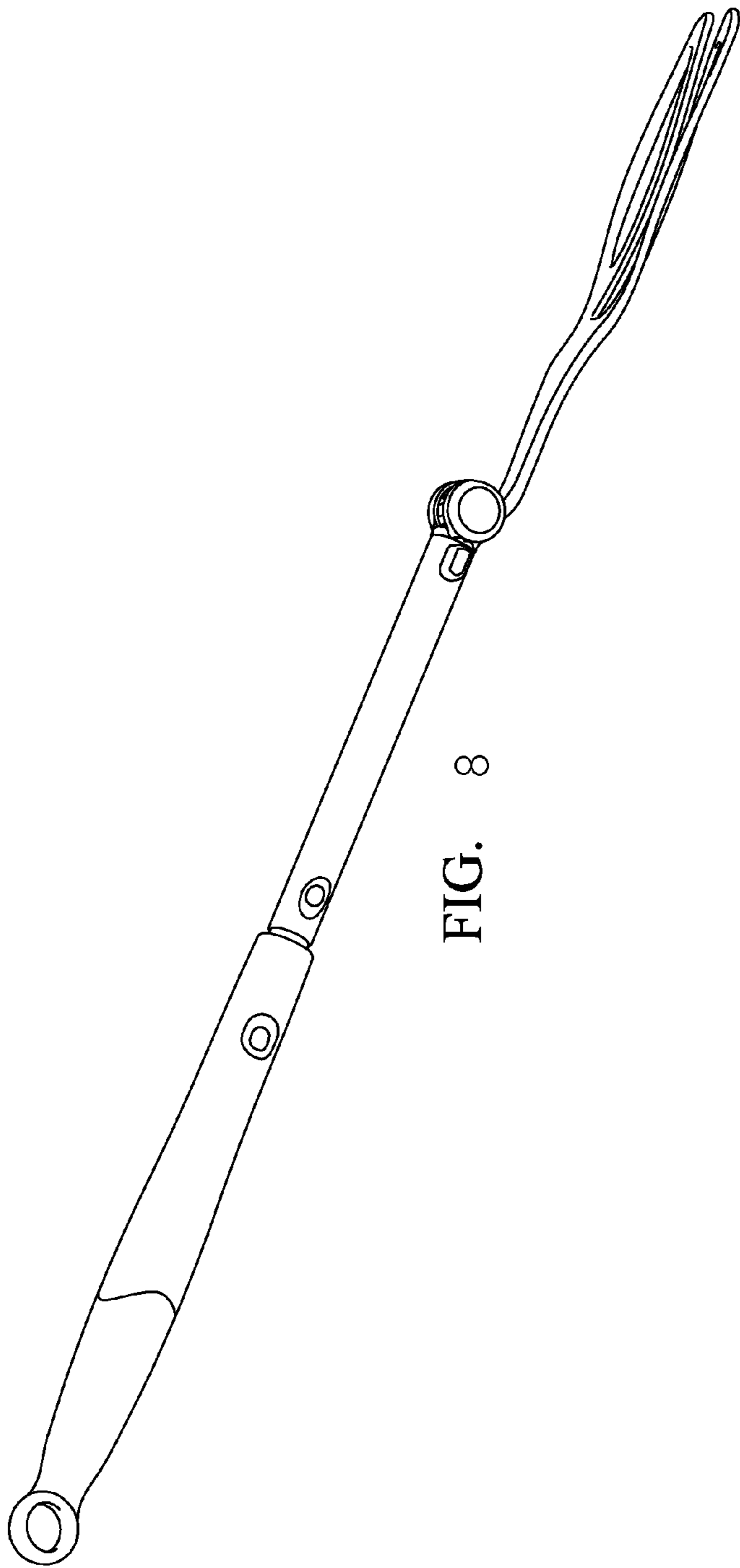

FIG. 8

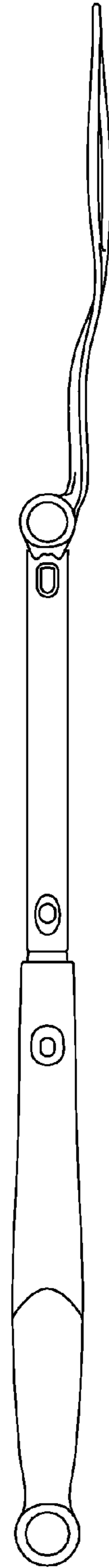

FIG. 9

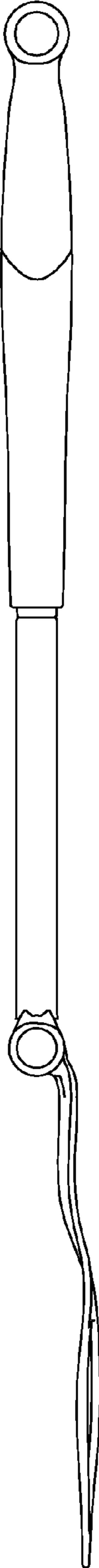

FIG. 10

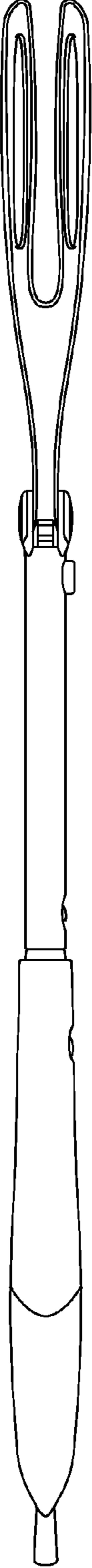

FIG. 11

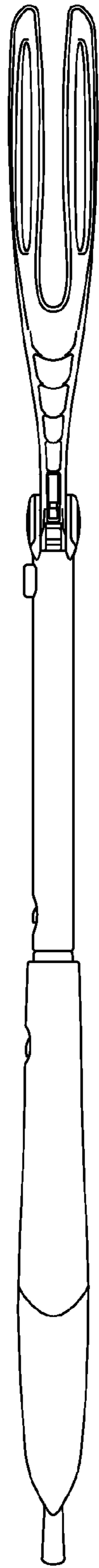

FIG. 12

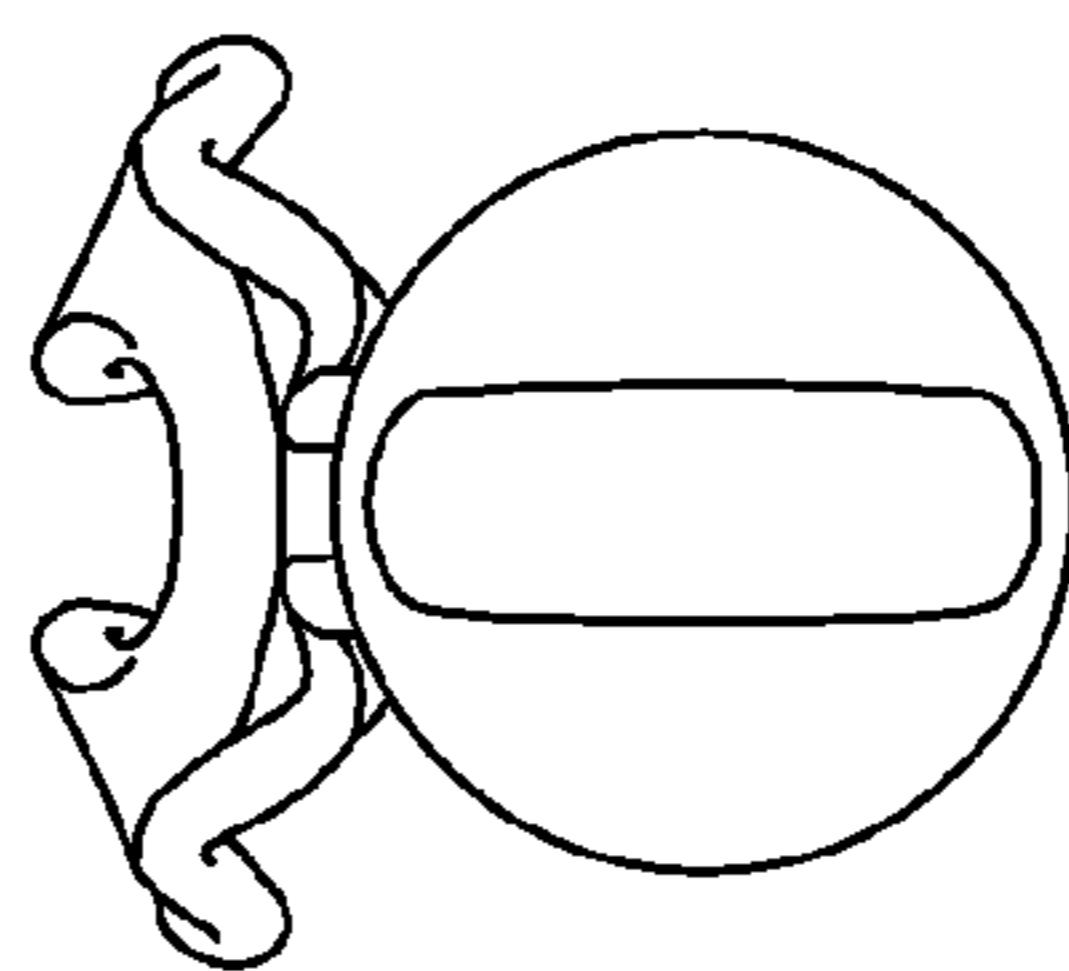

FIG. 13

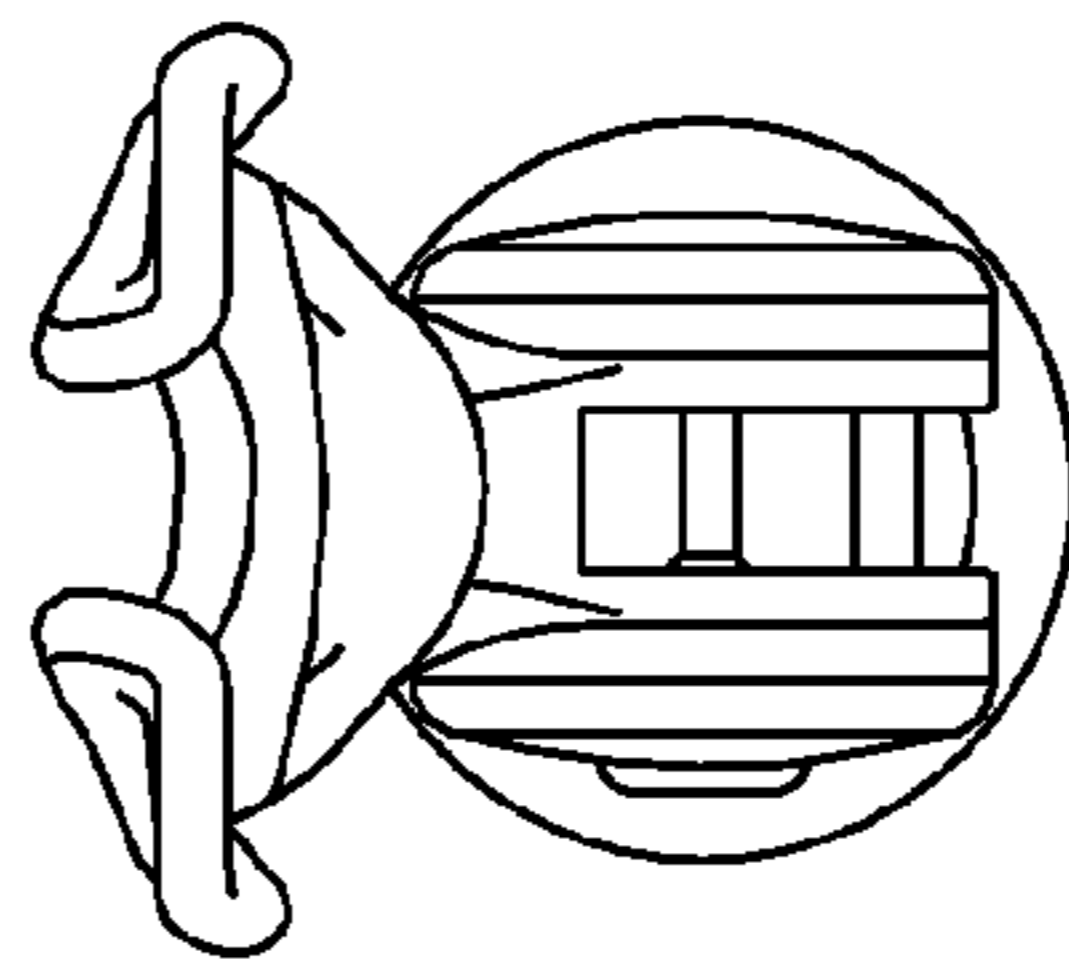

FIG. 14

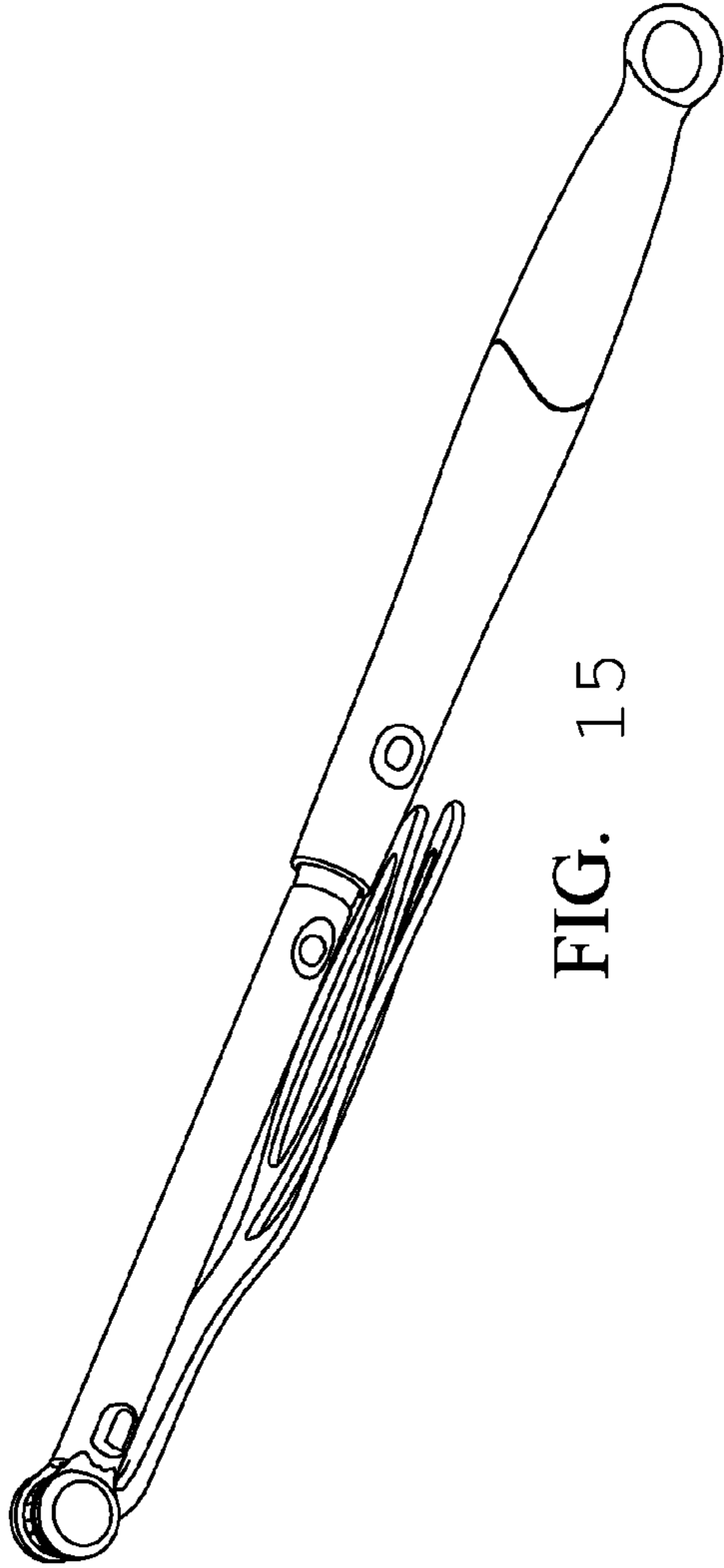

FIG. 15

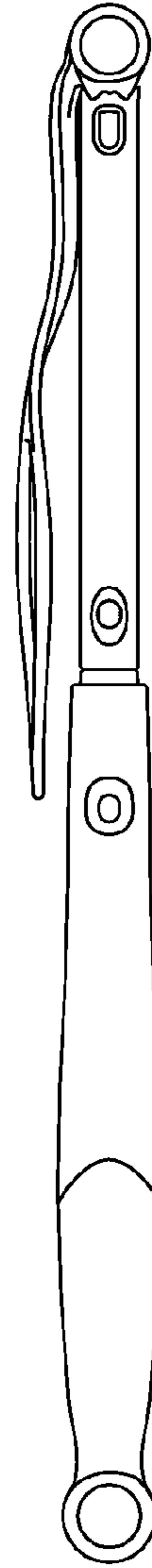

FIG. 16

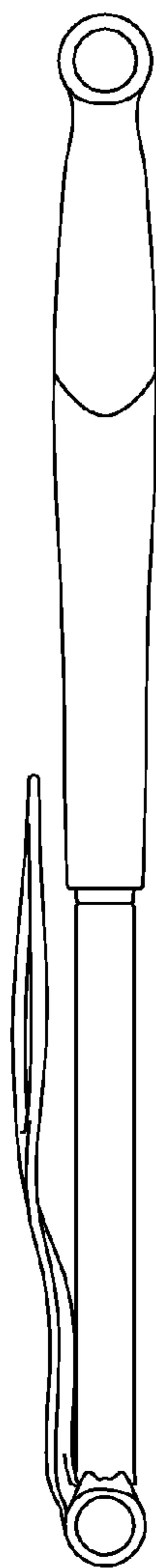

FIG. 17

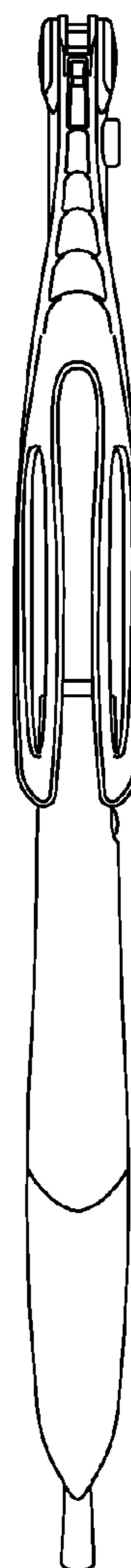

FIG. 18

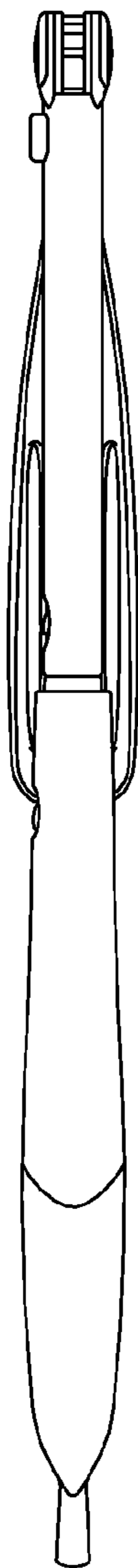

FIG. 19

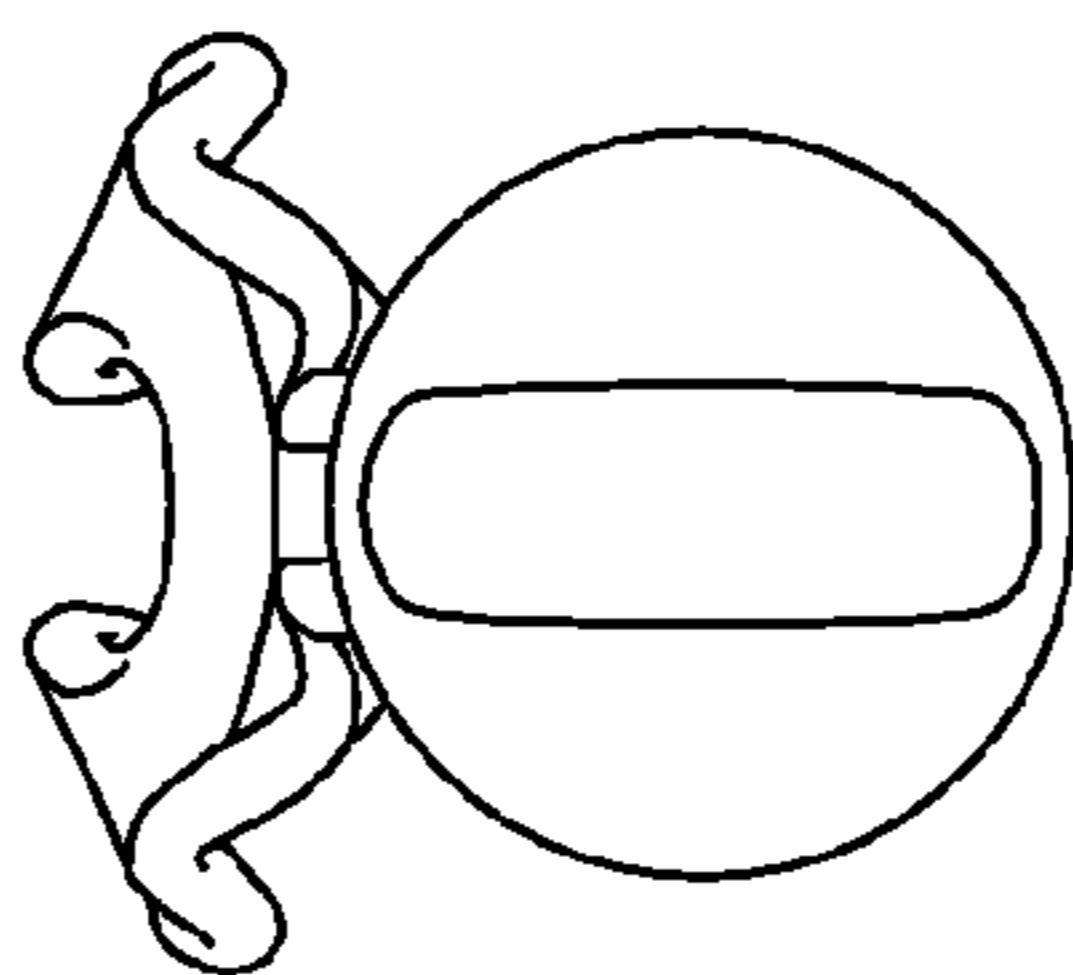

FIG. 20

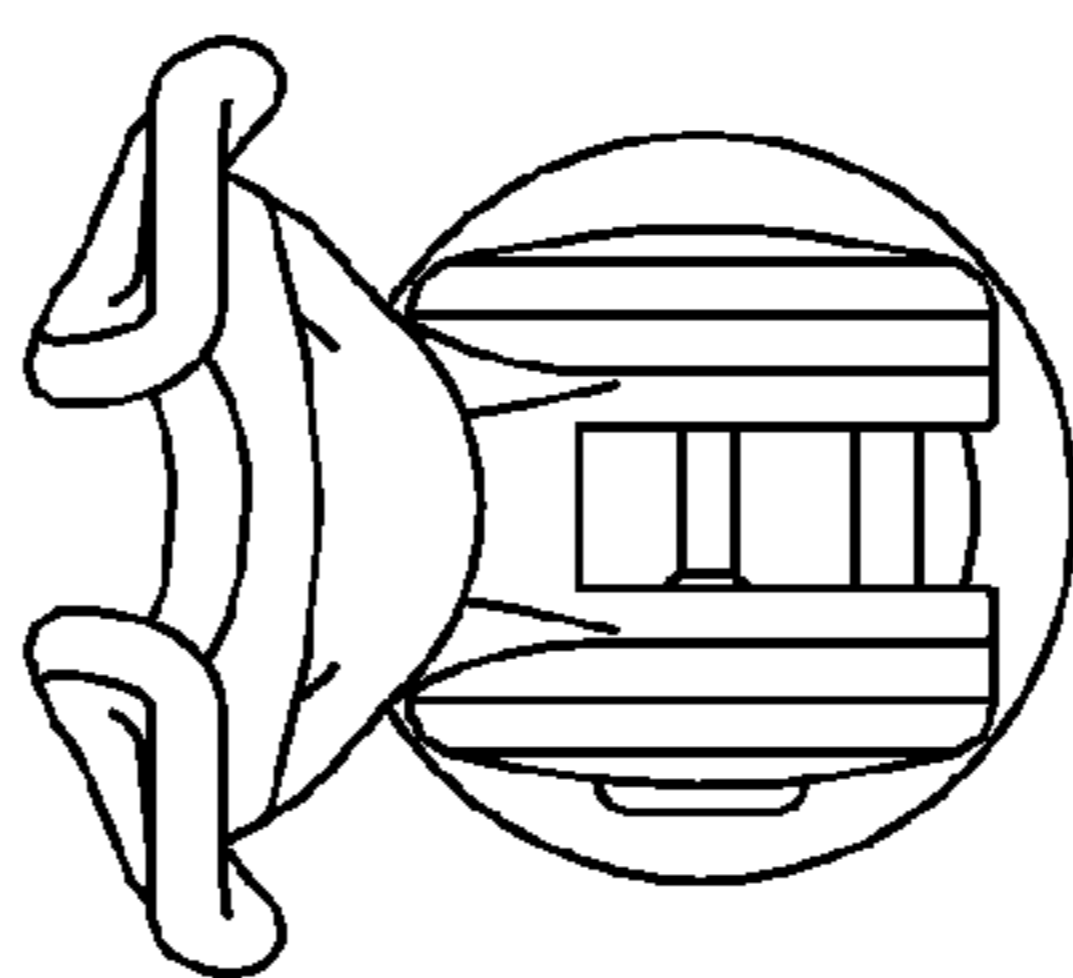

FIG. 21