



US00D674957S

(12) **United States Design Patent**
Sonneman

(10) **Patent No.:** **US D674,957 S**
(45) **Date of Patent:** **** Jan. 22, 2013**

(54) **LIGHT FIXTURE WITH A VARIETY OF LIGHT CLUSTERS**

(76) Inventor: **Robert A. Sonneman**, Mamaroneck, NY (US)

(**) Term: **14 Years**

(21) Appl. No.: **29/428,463**

(22) Filed: **Jul. 31, 2012**

Related U.S. Application Data

(62) Division of application No. 29/416,894, filed on Mar. 28, 2012.

(51) **LOC (9) Cl.** **26-03**

(52) **U.S. Cl.** **D26/104**

(58) **Field of Classification Search** D26/72, D26/75, 76, 80, 83, 84, 86, 87, 88-92, 93, D26/102, 104, 107, 124, 128; 362/147, 404-408, 362/410, 414, 432

See application file for complete search history.

(56) **References Cited**

U.S. PATENT DOCUMENTS

D63,702 S * 1/1924 Sinkins D26/91
D122,864 S * 10/1940 Dreyfuss D26/75

D155,340 S * 9/1949 Frisbie D26/93
3,212,713 A * 10/1965 Chatten 239/17
D235,914 S * 7/1975 Schacht D26/84
D240,156 S * 6/1976 von Serda D26/128
D241,066 S * 8/1976 Schacht D26/81
D265,134 S * 6/1982 Bessone et al. D26/93
D294,068 S * 2/1988 Platner D26/81
D619,291 S * 7/2010 Thevenot D26/75
D626,284 S * 10/2010 Zeisner D26/154
D627,503 S * 11/2010 Postelmans D26/93
D645,603 S * 9/2011 Overy et al. D26/93

* cited by examiner

Primary Examiner — Clare E Heflin

(74) *Attorney, Agent, or Firm* — Gottlieb, Rackman & Reisman, P.C.

(57) **CLAIM**

The ornamental design for a light fixture with a variety of light clusters, as shown and described.

DESCRIPTION

FIG. 1 is a perspective view of the light fixture with a variety of light clusters showing my new design;
FIG. 2 is a top plan view thereof;
FIG. 3 is a front side elevational view thereof;
FIG. 4 is a right side elevational view thereof;
FIG. 5 is a left side elevational view thereof;
FIG. 6 is a rear elevational view thereof; and,
FIG. 7 is a bottom plan view thereof.

1 Claim, 4 Drawing Sheets

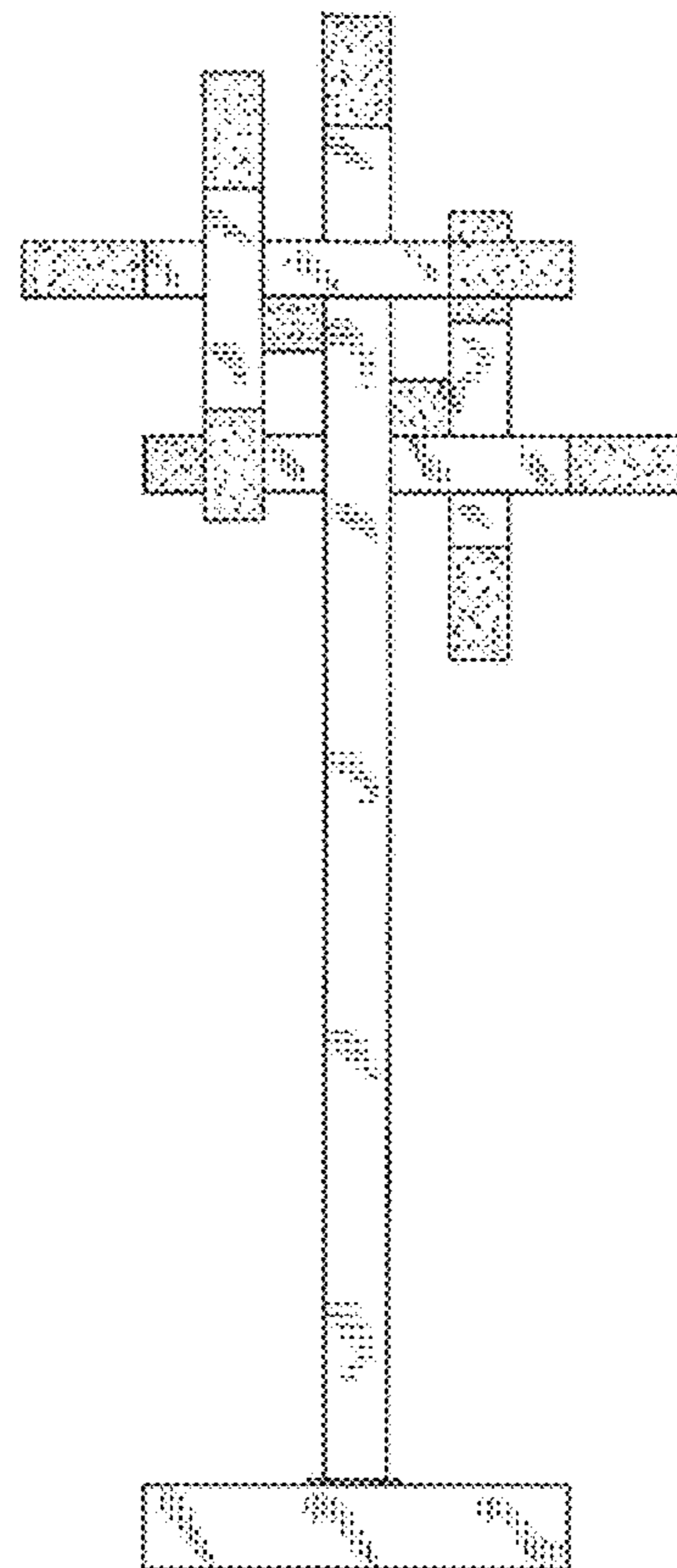
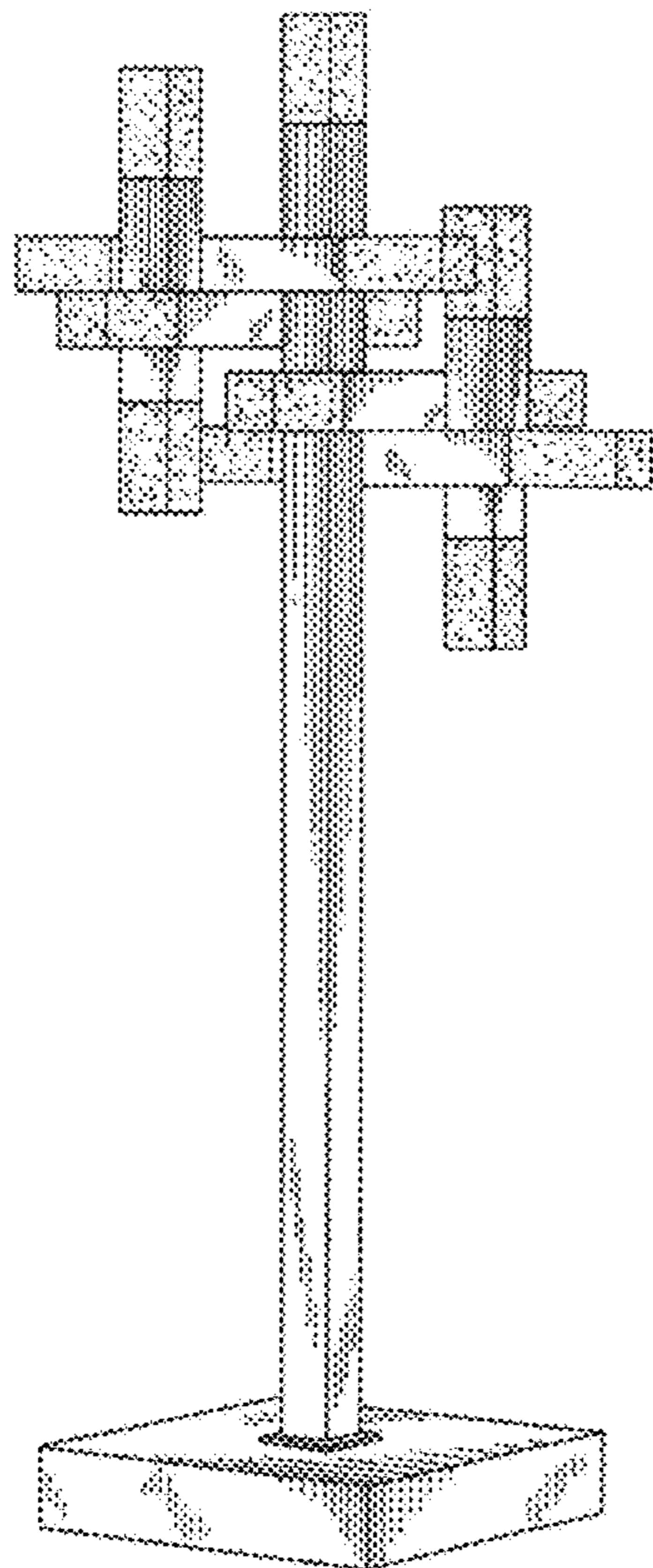

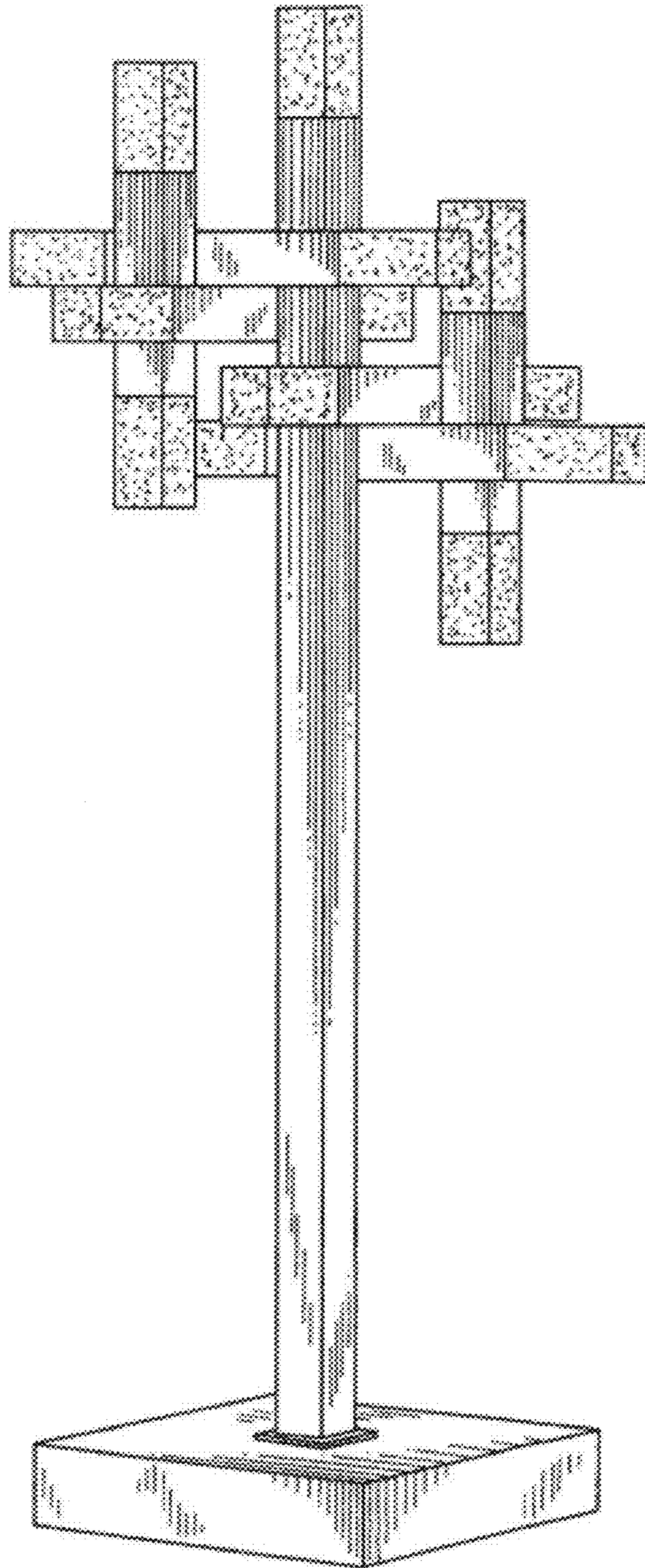

FIG. 1

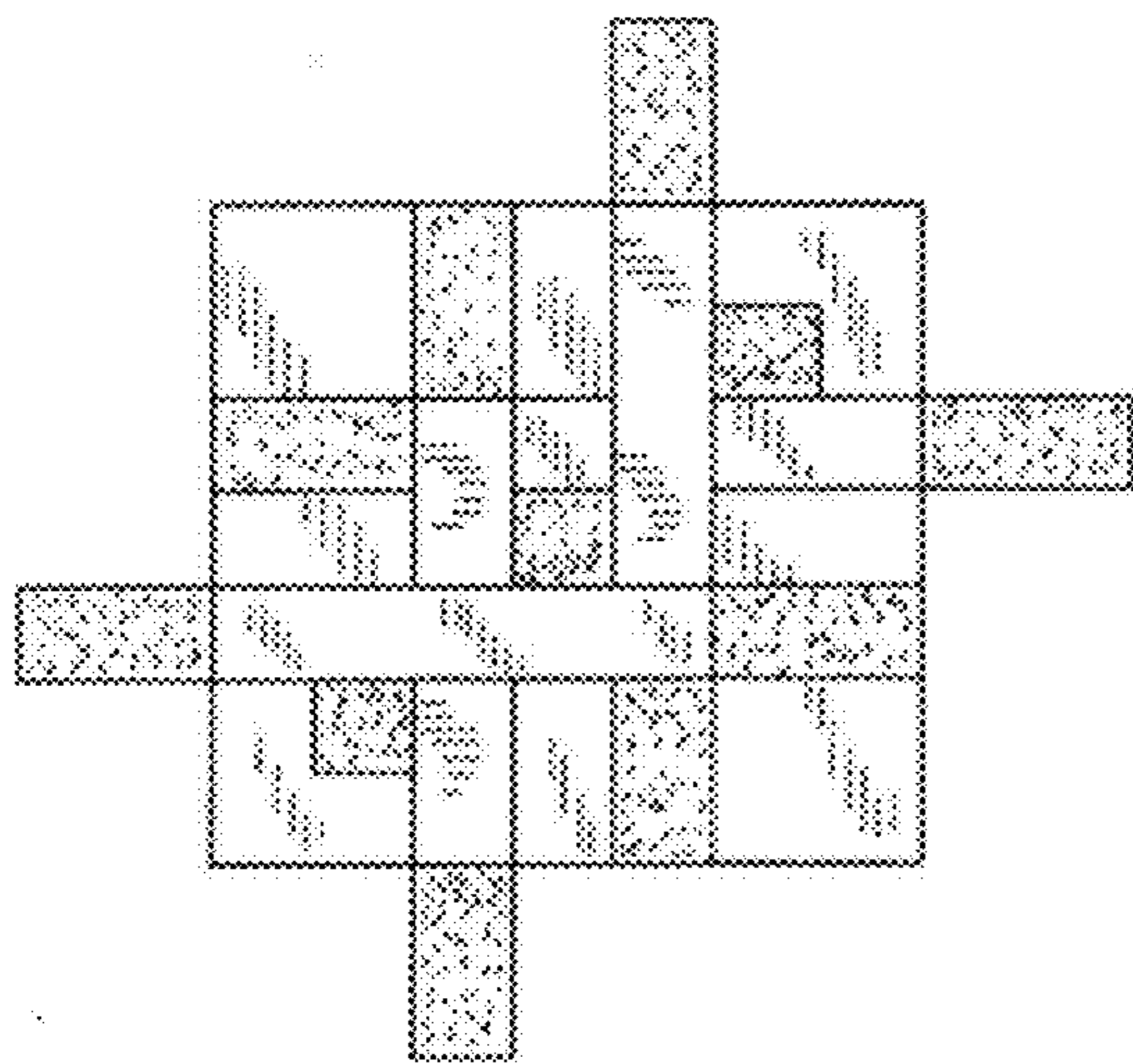

FIG. 2

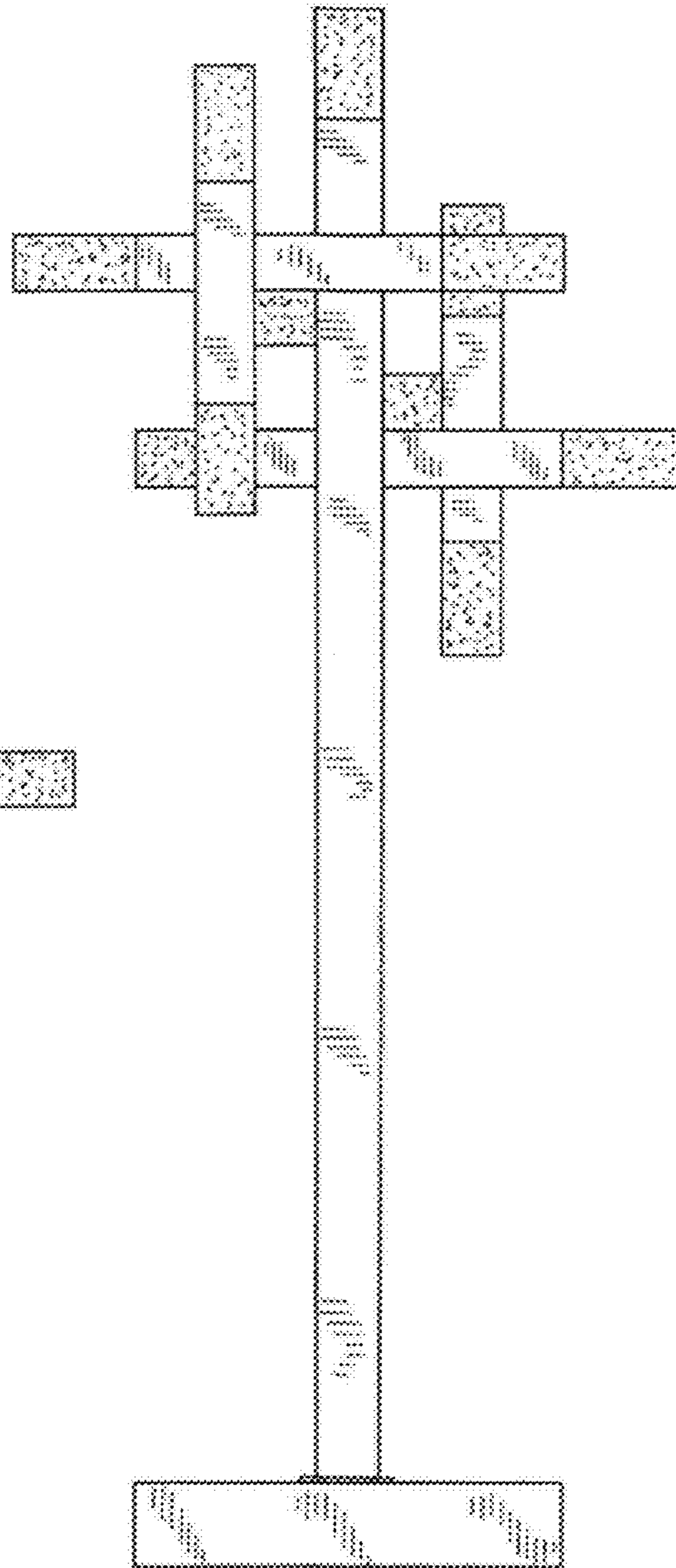

FIG. 3

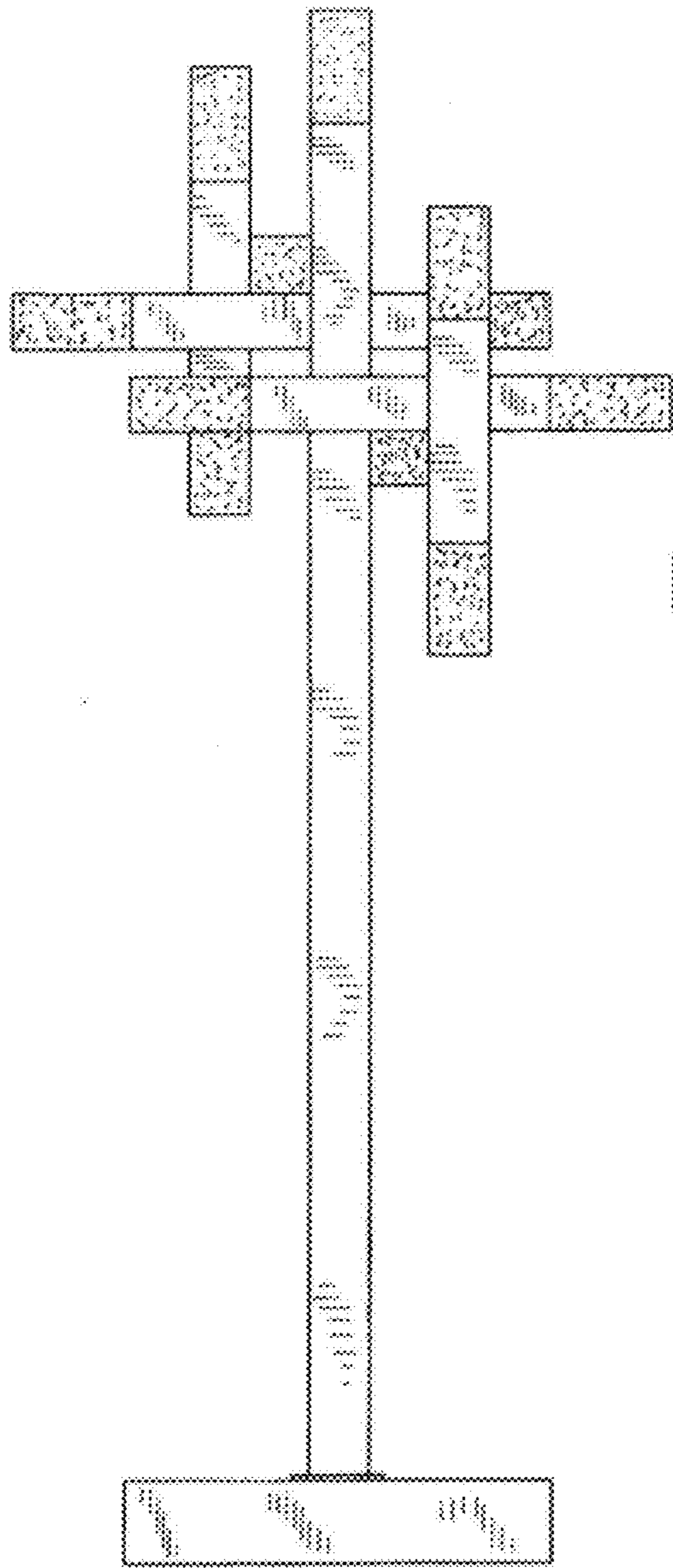

FIG. 4

FIG. 5

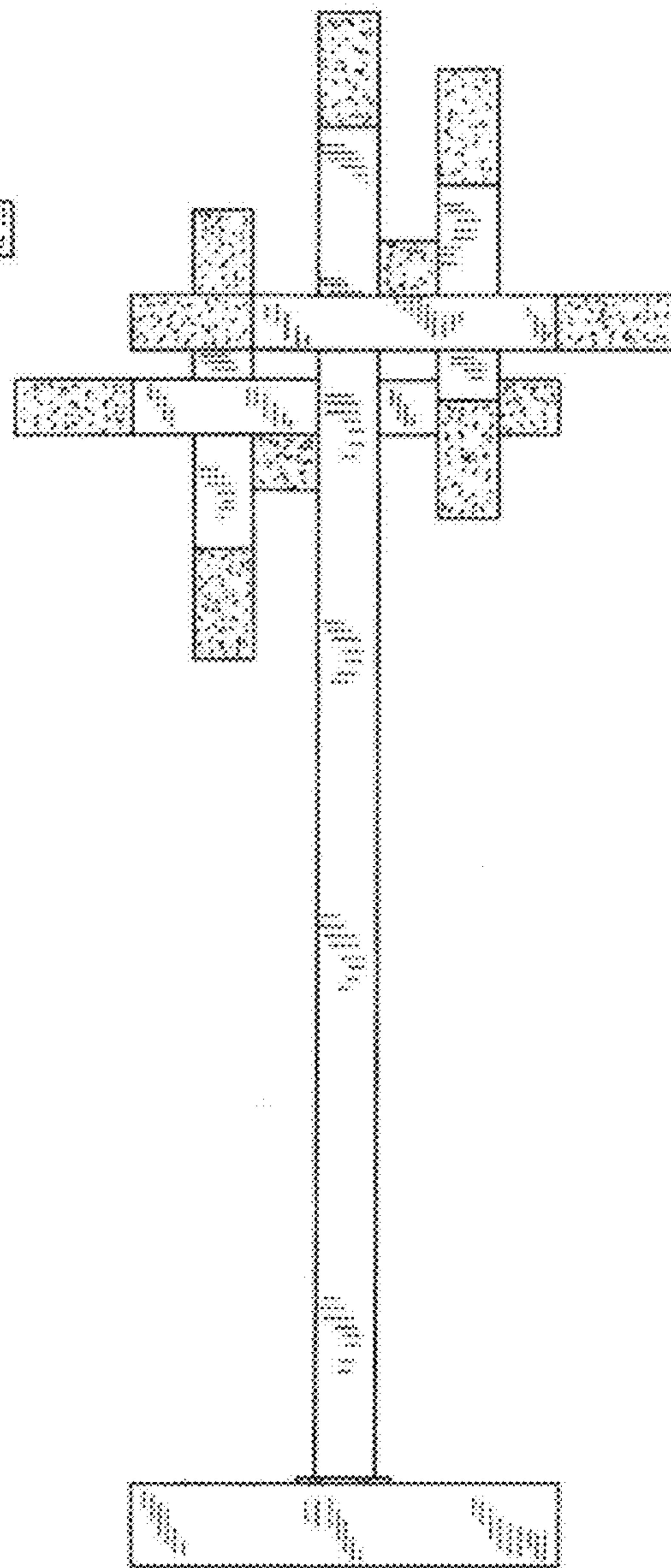

FIG. 6

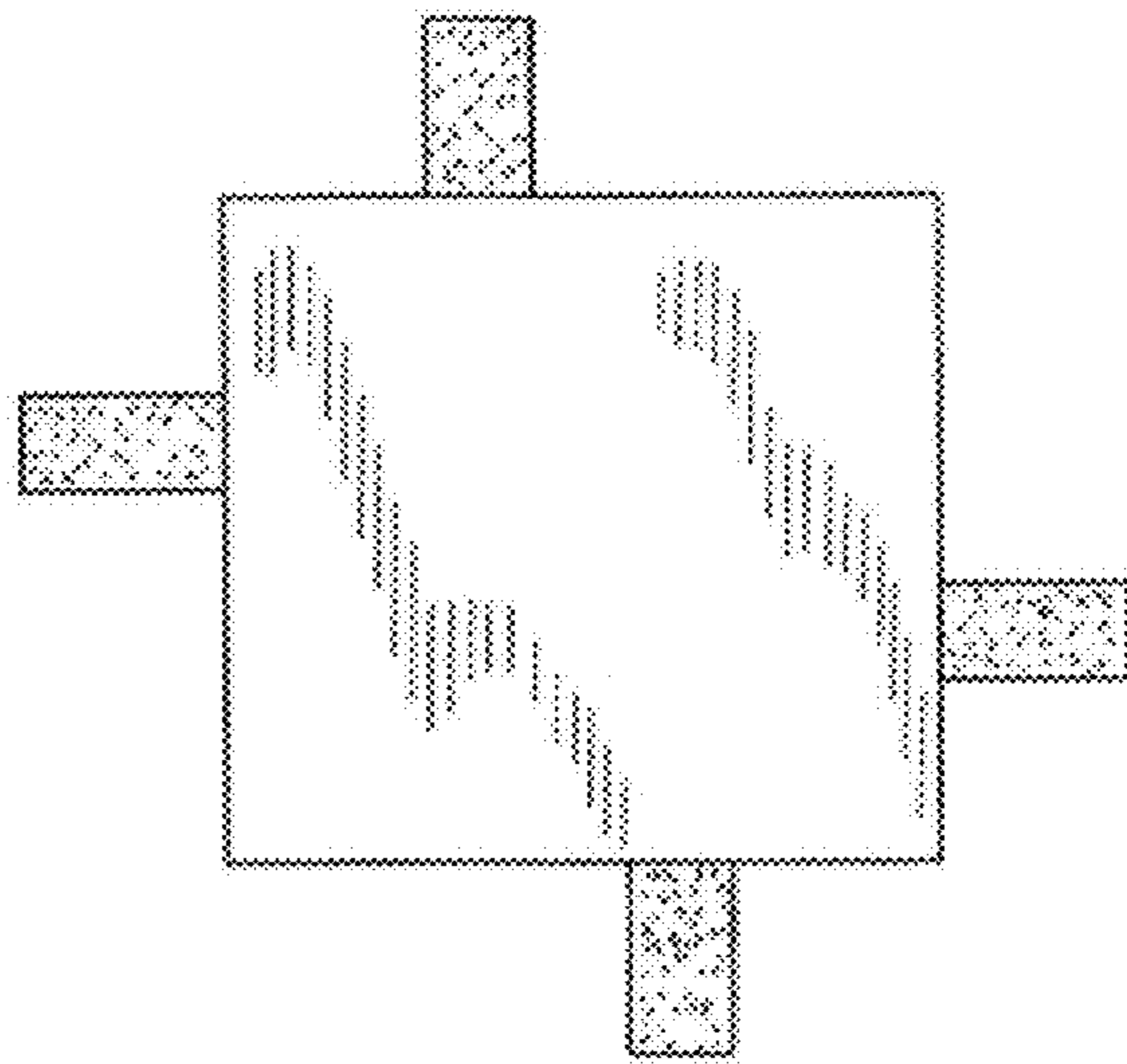
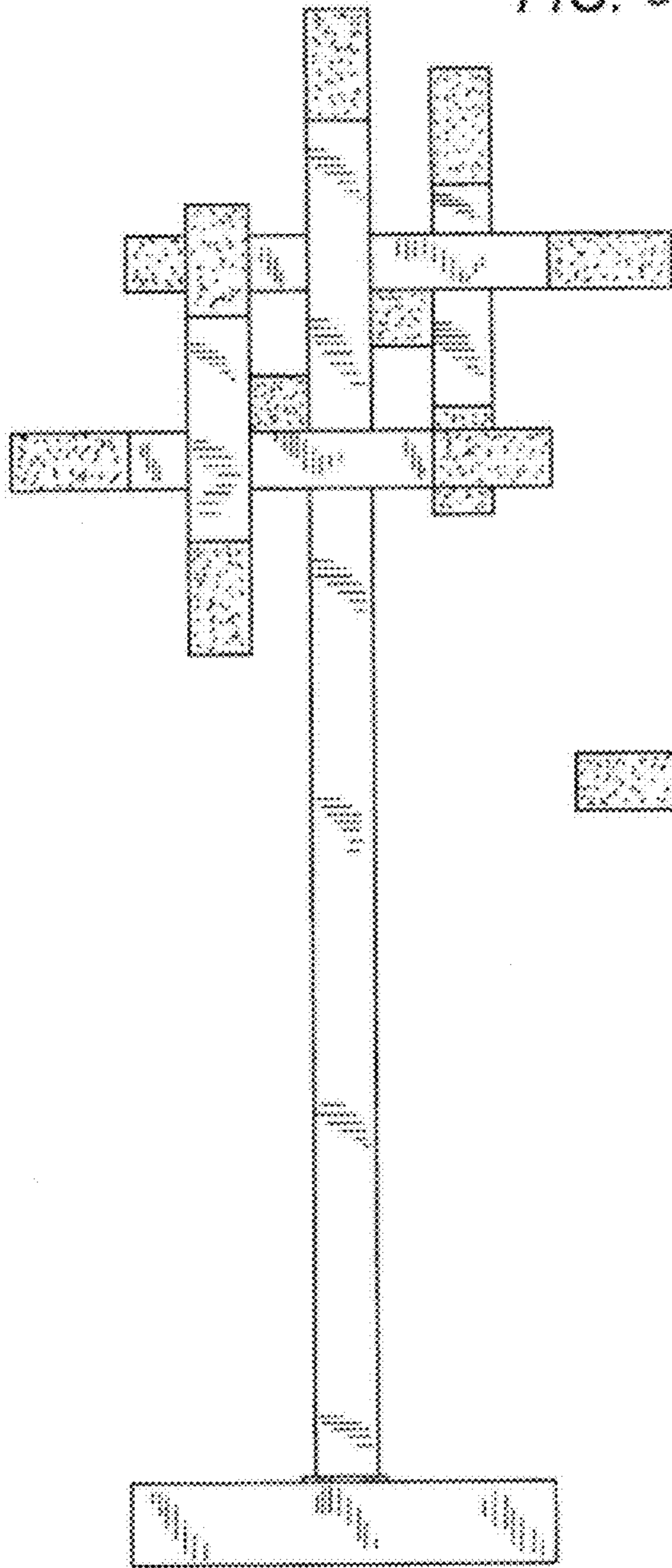

FIG. 7