



US00D674910S

(12) **United States Design Patent**
Adams et al.

(10) **Patent No.:** **US D674,910 S**
(45) **Date of Patent:** **** Jan. 22, 2013**

(54) **VIBRATING RING**

(75) Inventors: **Jesse Adams**, Seattle, WA (US); **Bruce Tetreault**, Newtown, PA (US); **Ming Zeng**, Edison, NJ (US)

(73) Assignee: **Church & Dwight Co., Inc.**, Princeton, NJ (US)

(**) Term: **14 Years**

(21) Appl. No.: **29/415,981**

(22) Filed: **Mar. 16, 2012**

(51) **LOC (9) Cl.** **28-03**

(52) **U.S. Cl.** **D24/215**

(58) **Field of Classification Search** D24/200,
D24/211–215, 141; 601/27, 28, 33, 40, 46,
601/47, 48, 63, 80, 99, 104, 112, 113, 114,
601/119, 122, 125, 129, 134, 135, 137, DIG. 12,
601/DIG. 13, DIG. 14, DIG. 15, DIG. 16,
601/DIG. 17

See application file for complete search history.

(56) **References Cited**

U.S. PATENT DOCUMENTS

5,524,638	A	6/1996	Lyons	
D463,751	S	10/2002	Wilkinson	
6,490,885	B1	12/2002	Wilkinson	
D496,458	S	9/2004	Lin	
6,790,189	B2	9/2004	Kobayashi et al.	
6,863,649	B2	3/2005	Yasue	
6,907,883	B2	6/2005	Lin	
D523,958	S	6/2006	Fang	
7,108,668	B2	9/2006	Fang	
D552,748	S *	10/2007	Gromosaik et al.	D24/215
D552,749	S *	10/2007	Gromosaik et al.	D24/215
D552,750	S *	10/2007	Gromosaik et al.	D24/215
D557,805	S *	12/2007	Gromosaik et al.	D24/143
D557,806	S *	12/2007	Gromosaik et al.	D24/143
D566,289	S	4/2008	Tasker et al.	
D581,544	S *	11/2008	Adams	D24/215
D637,302	S *	5/2011	Post	D24/215
D637,303	S *	5/2011	Post	D24/215
D643,129	S *	8/2011	Talbot et al.	D24/215
2005/0155609	A1	7/2005	Lin	

2005/0283044 A1 12/2005 Chang
2006/0178602 A1 8/2006 Teng et al.
2007/0038019 A1 2/2007 Weng
2007/0051373 A1 3/2007 Lin
2008/0027361 A1 1/2008 Lin

* cited by examiner

Primary Examiner — Sandra Snapp

(74) *Attorney, Agent, or Firm* — Frankel & Associates, P.C.

(57) **CLAIM**

We claim the ornamental design for a vibrating ring, as shown and described.

DESCRIPTION

FIG. 1 is a perspective view of the vibrating ring of this invention;
FIG. 2 is a front view of the vibrating ring of this invention;
FIG. 3 is a rear view of the vibrating ring of this invention;
FIG. 4 is a side view of the vibrating ring of this invention;
FIG. 5 is an opposite side view of the vibrating ring of this invention;
FIG. 6 is a bottom view of the vibrating ring of this invention;
FIG. 7 is a top view of the vibrating ring of this invention;
FIG. 8 is a perspective view of an alternative vibrating ring of this invention;
FIG. 9 is a front view of an alternative vibrating ring of this invention;
FIG. 10 is a rear view of an alternative vibrating ring of this invention;
FIG. 11 is a side view of an alternative vibrating ring of this invention;
FIG. 12 is an opposite side view of an alternative vibrating ring of this invention;
FIG. 13 is a bottom view of an alternative vibrating ring of this invention;
FIG. 14 is a top view of an alternative vibrating ring of this invention;
FIG. 15 is a perspective view of a second alternative vibrating ring of this invention;
FIG. 16 is a front view of a second alternative vibrating ring of this invention;

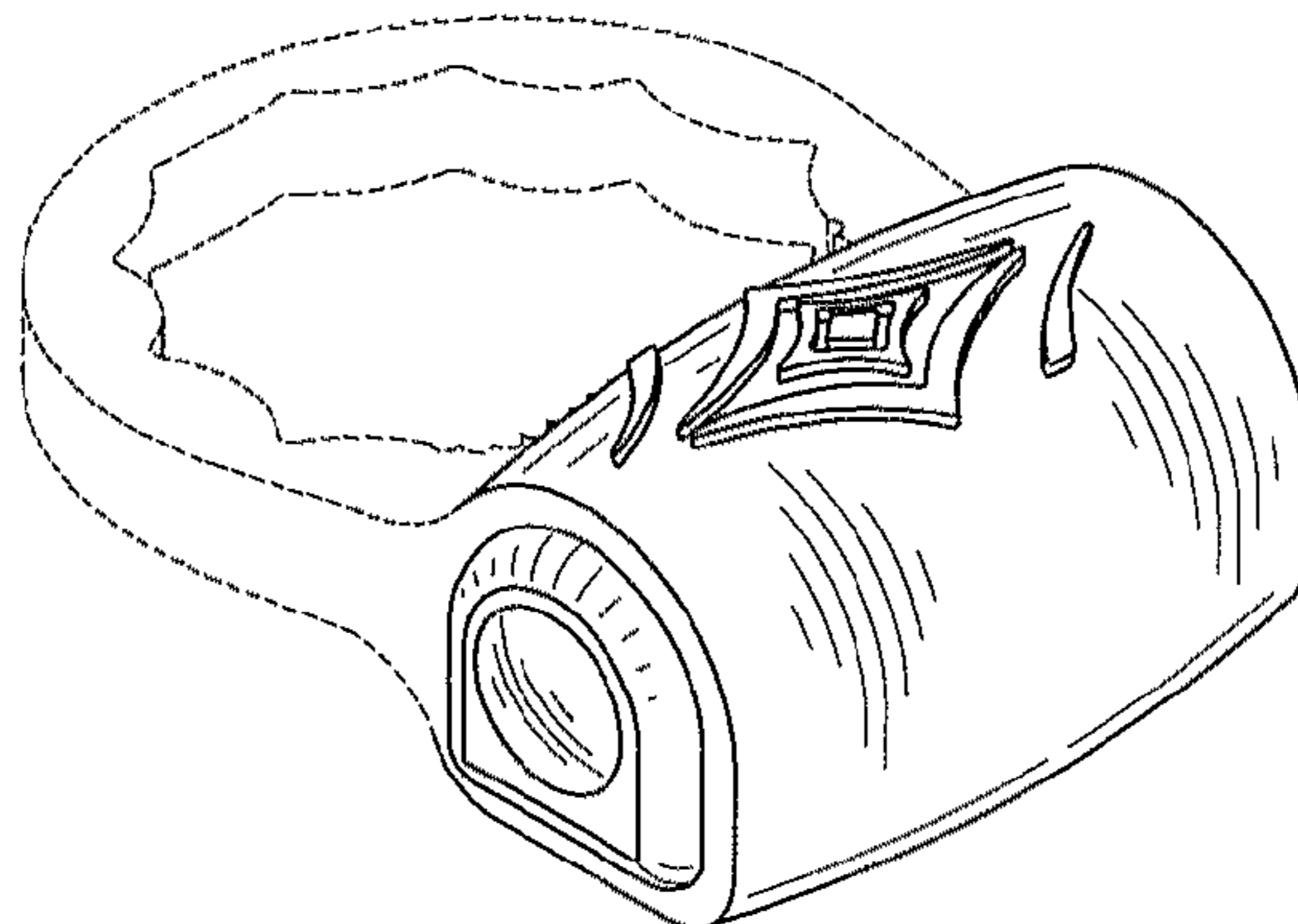

FIG. 17 is a rear view of a second alternative vibrating ring of this invention;

FIG. 18 is a side view of a second alternative vibrating ring of this invention;

FIG. 19 is an opposite side view of a second alternative vibrating ring of this invention;

FIG. 20 is a bottom view of a second alternative vibrating ring of this invention;

FIG. 21 is a top view of a second alternative vibrating ring of this invention;

FIG. 22 is a perspective view of a third alternative vibrating ring of this invention;

FIG. 23 is a front view of a third alternative vibrating ring of this invention;

FIG. 24 is a rear view of a third alternative vibrating ring of this invention;

FIG. 25 is a side view of a third alternative vibrating ring of this invention;

FIG. 26 is an opposite side view of a third alternative vibrating ring of this invention;

FIG. 27 is a bottom view of a third alternative vibrating ring of this invention;

FIG. 28 is a top view of a third alternative vibrating ring of this invention;

FIG. 29 is a perspective view of a fourth alternative vibrating ring of this invention;

FIG. 30 is a front view of a fourth alternative vibrating ring of this invention;

FIG. 31 is a rear view of a fourth alternative vibrating ring of this invention;

FIG. 32 is a side view of a fourth alternative vibrating ring of this invention;

FIG. 33 is an opposite side view of a fourth alternative vibrating ring of this invention;

FIG. 34 is a bottom view of a fourth alternative vibrating ring of this invention; and,

FIG. 35 is a top view of a fourth alternative vibrating ring of this invention.

The dotted line showing of the vibrating ring is for illustrative purposes only and forms no part of the claimed design.

1 Claim, 10 Drawing Sheets

Fig. 1

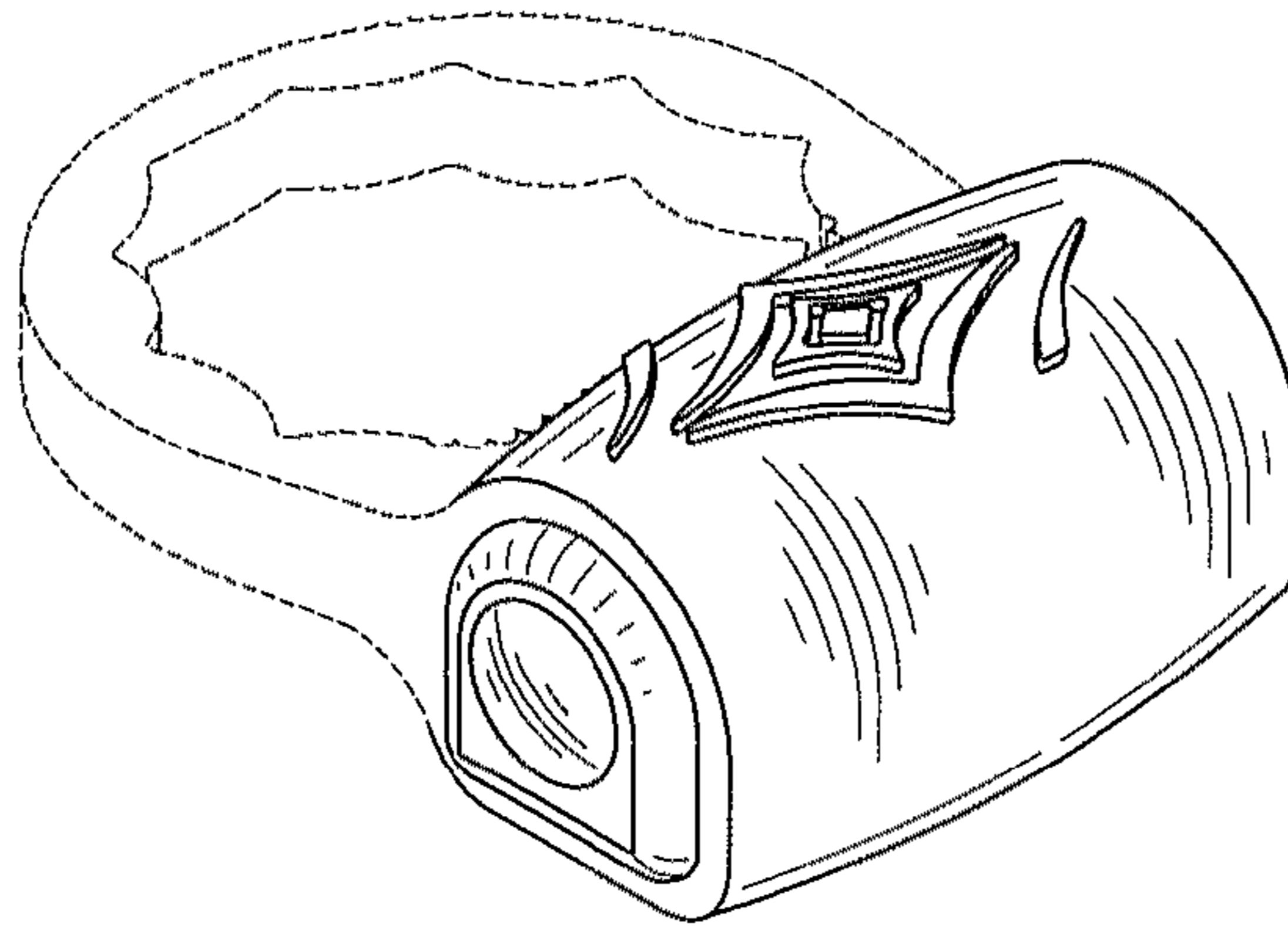

Fig. 2

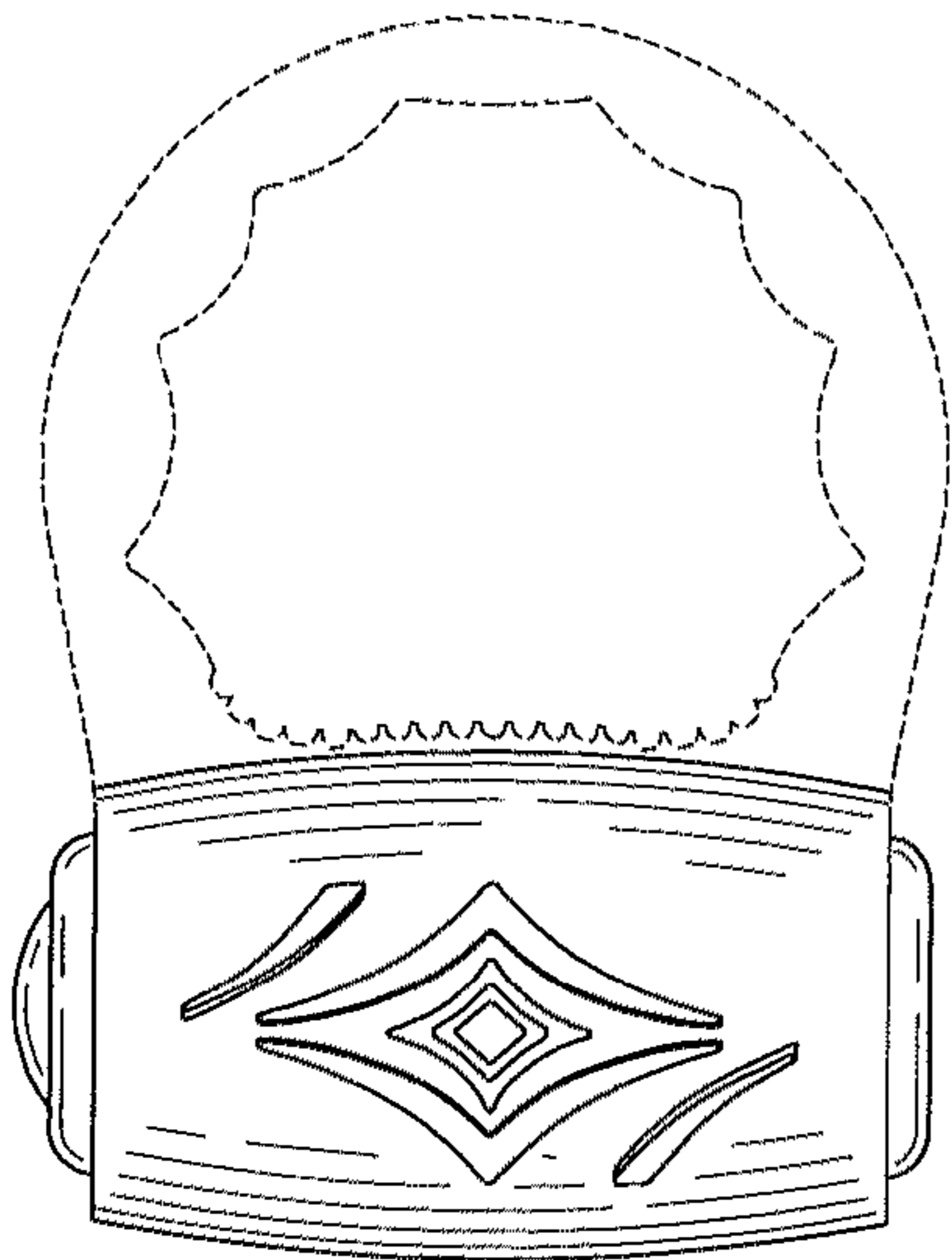

Fig. 3

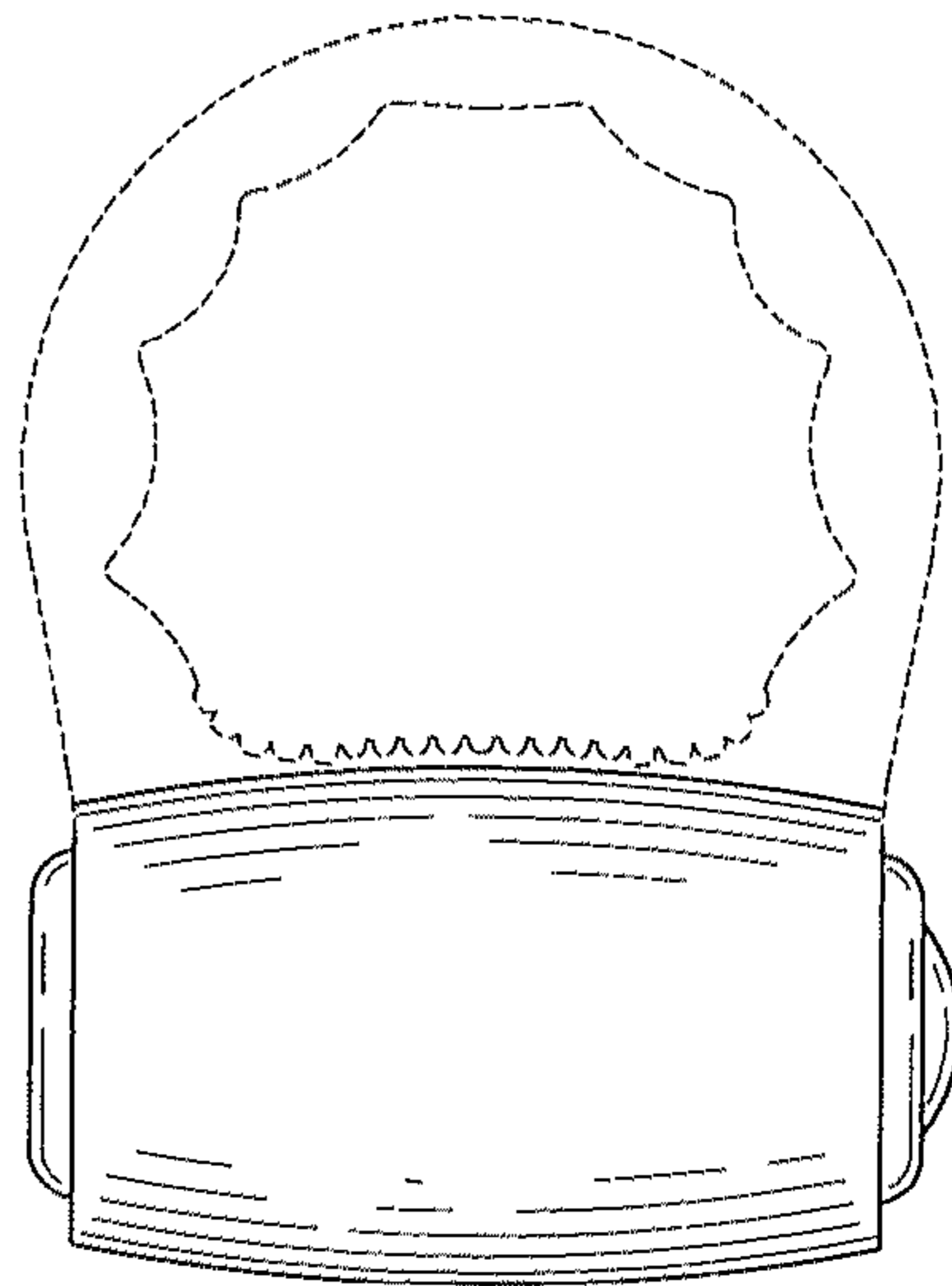

Fig. 4

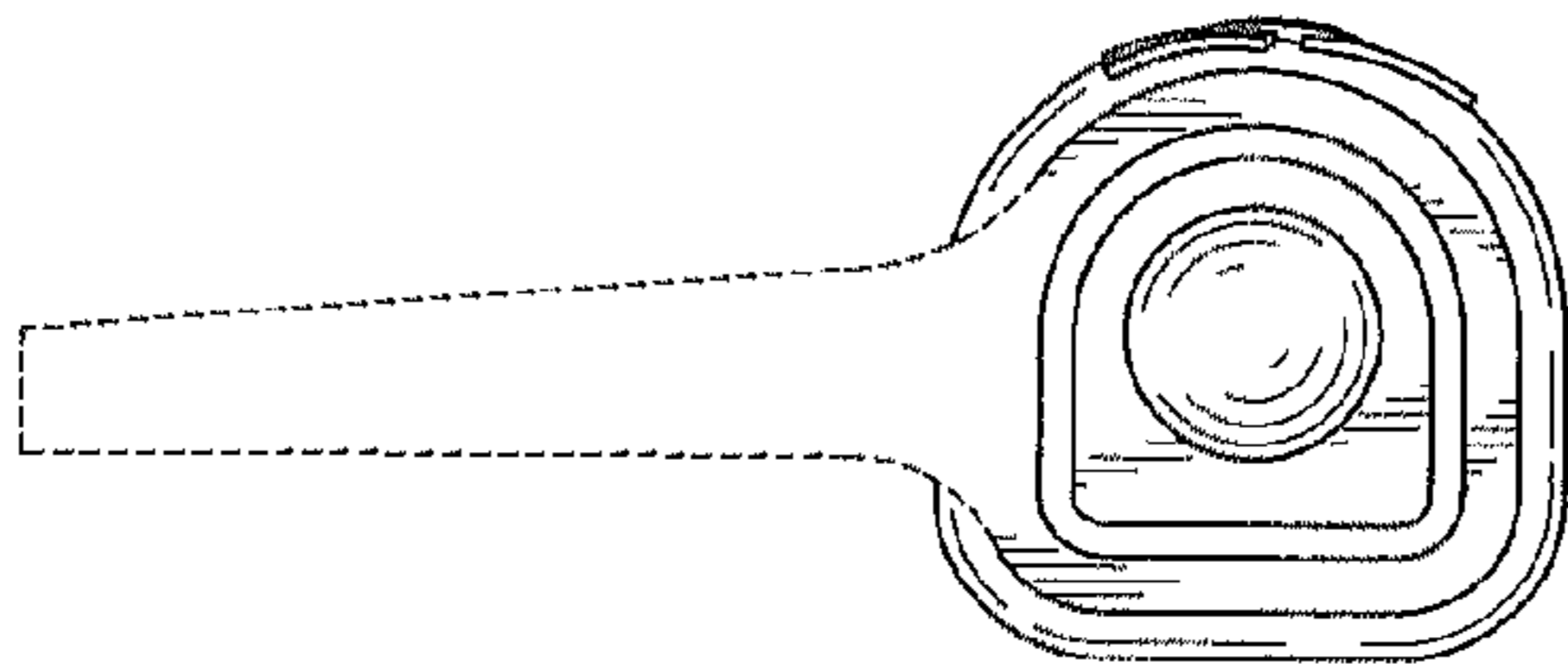

Fig. 5

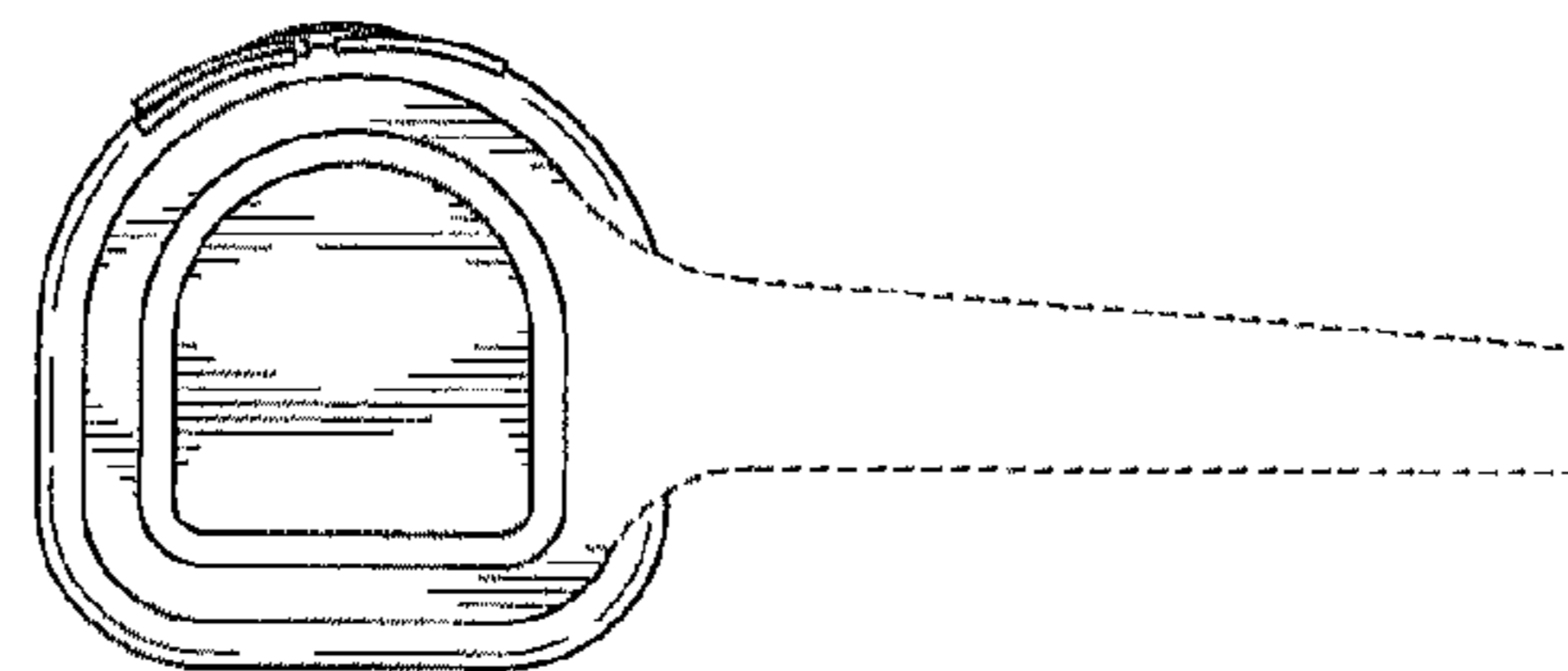

Fig. 6

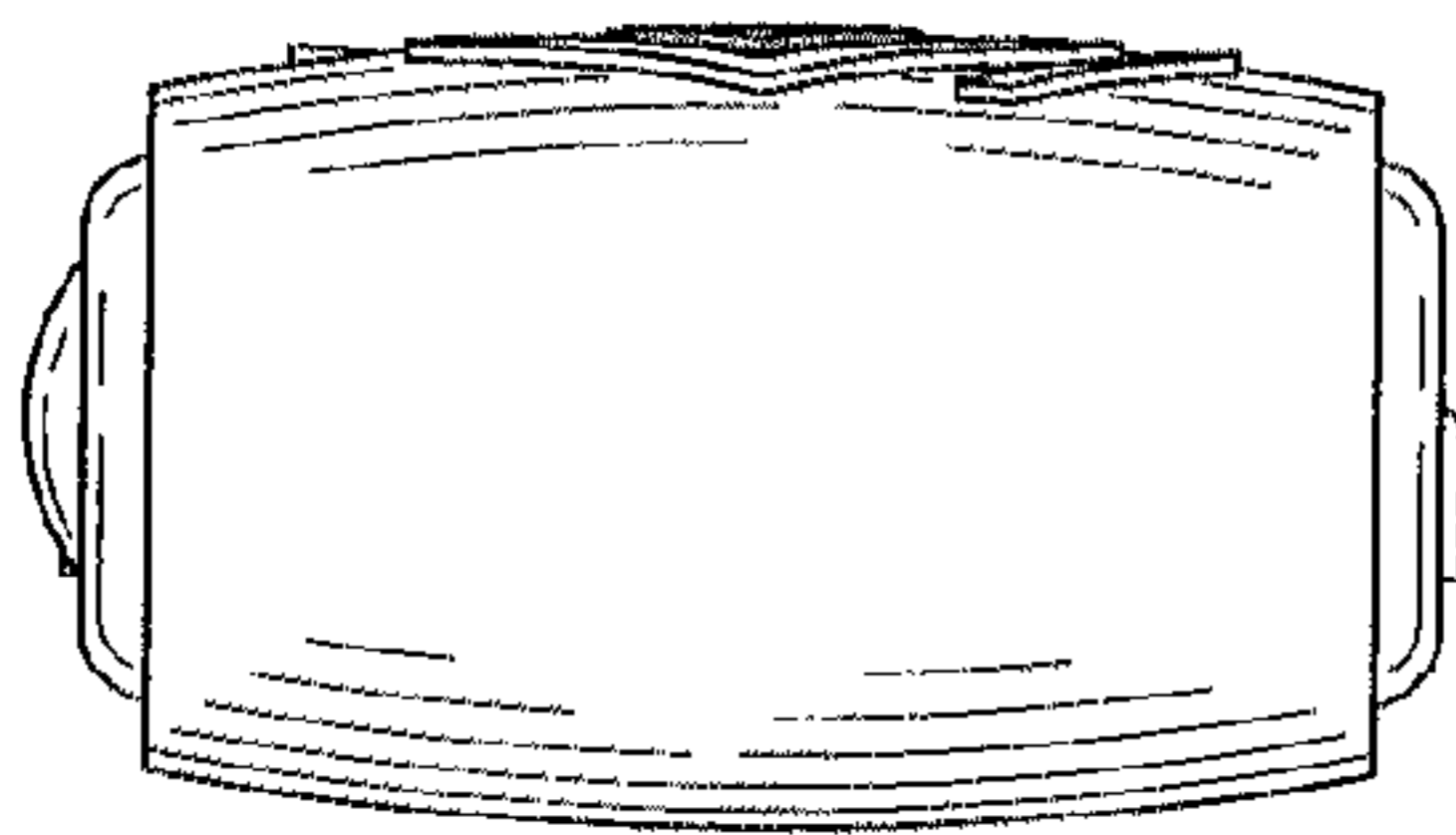

Fig. 7

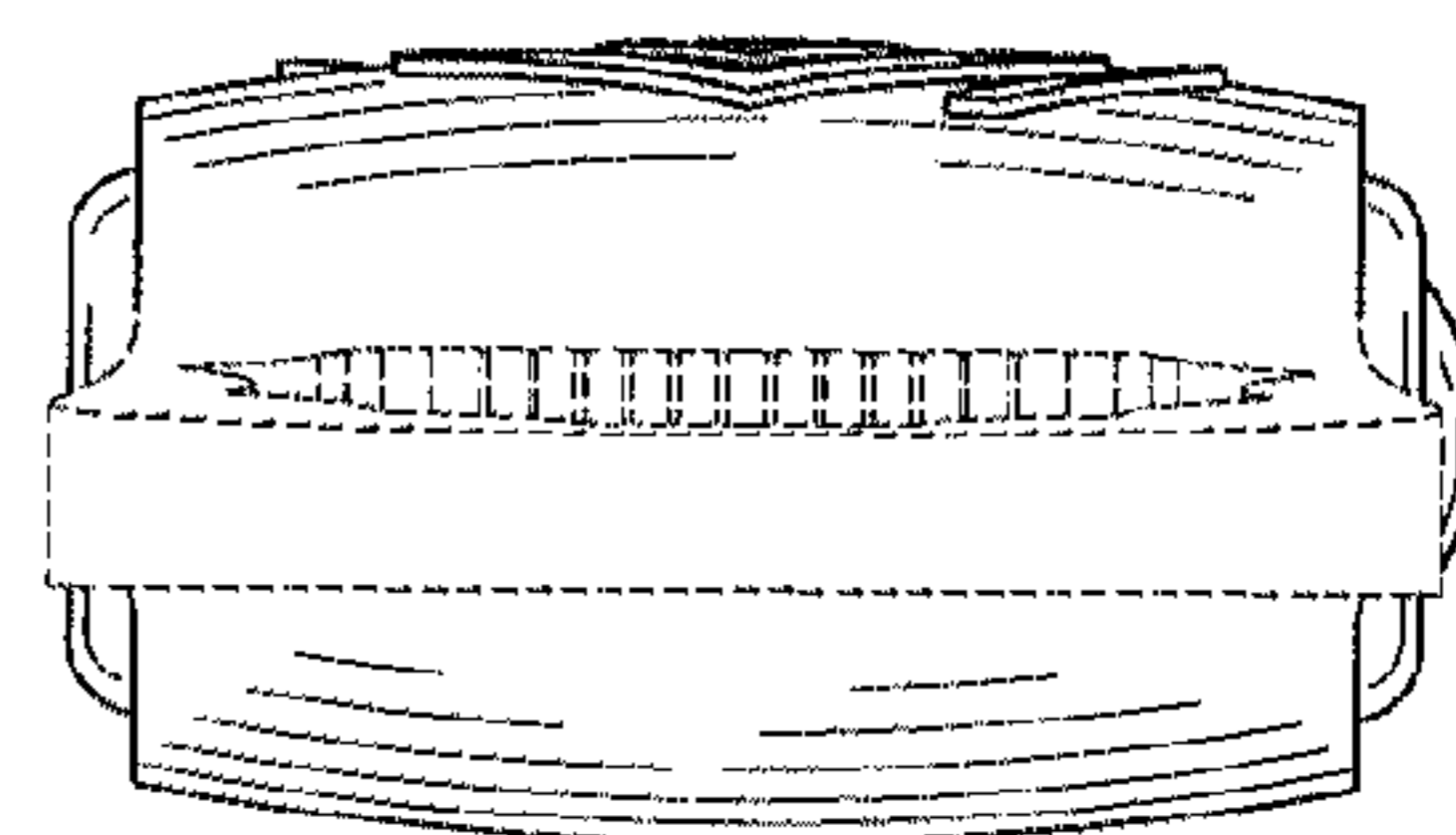

Fig. 8

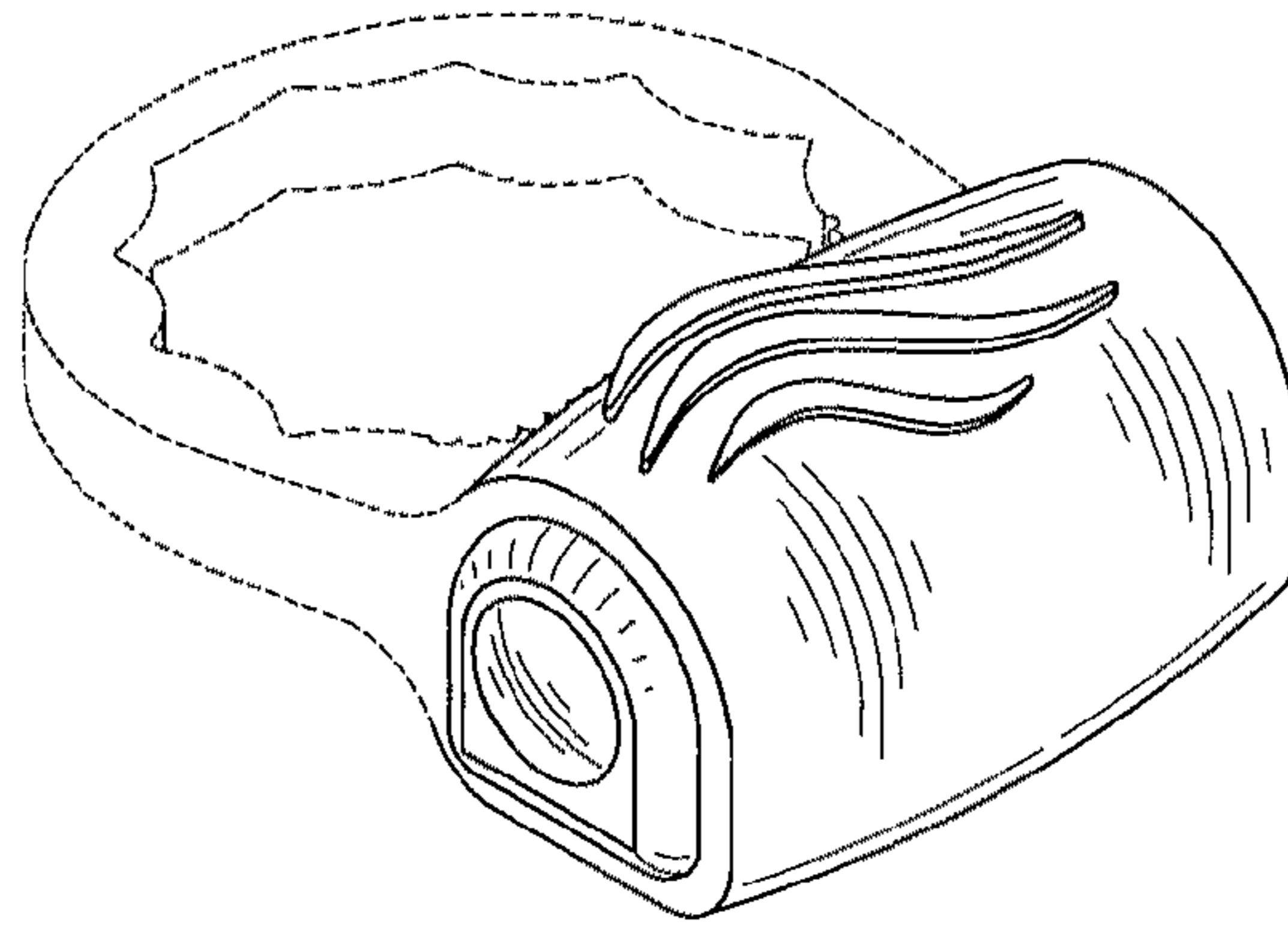

Fig. 9

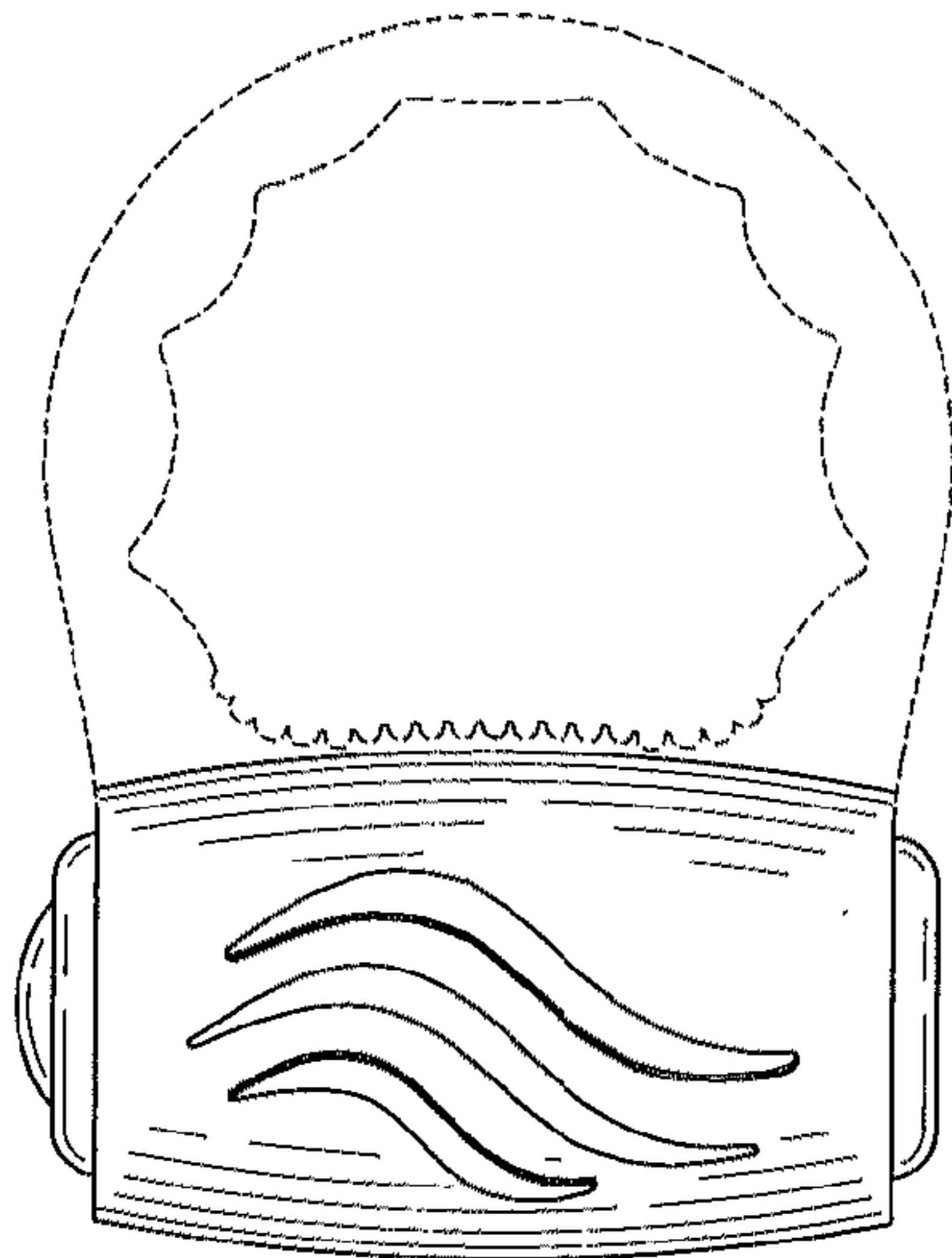

Fig. 10

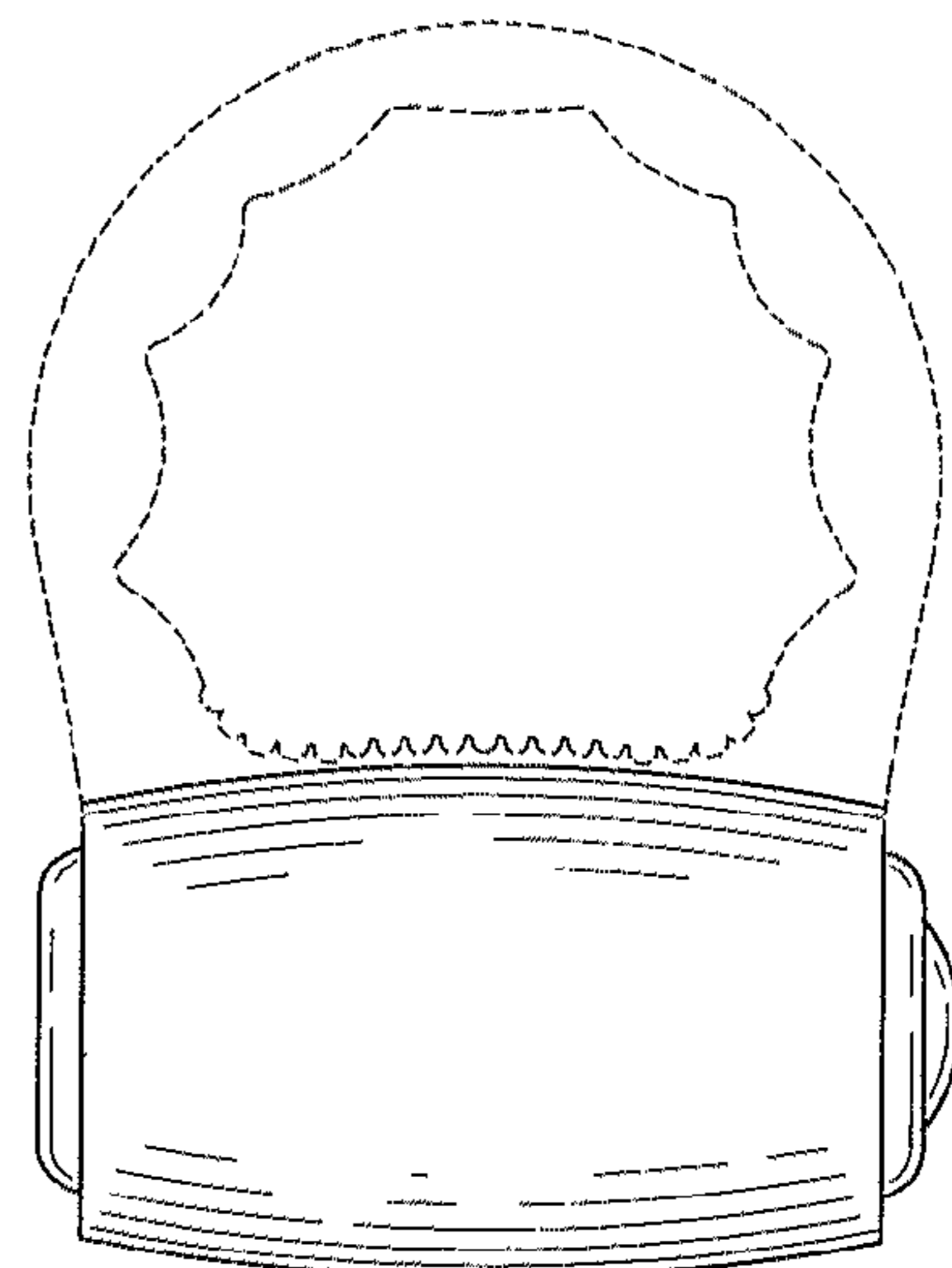

Fig. 11

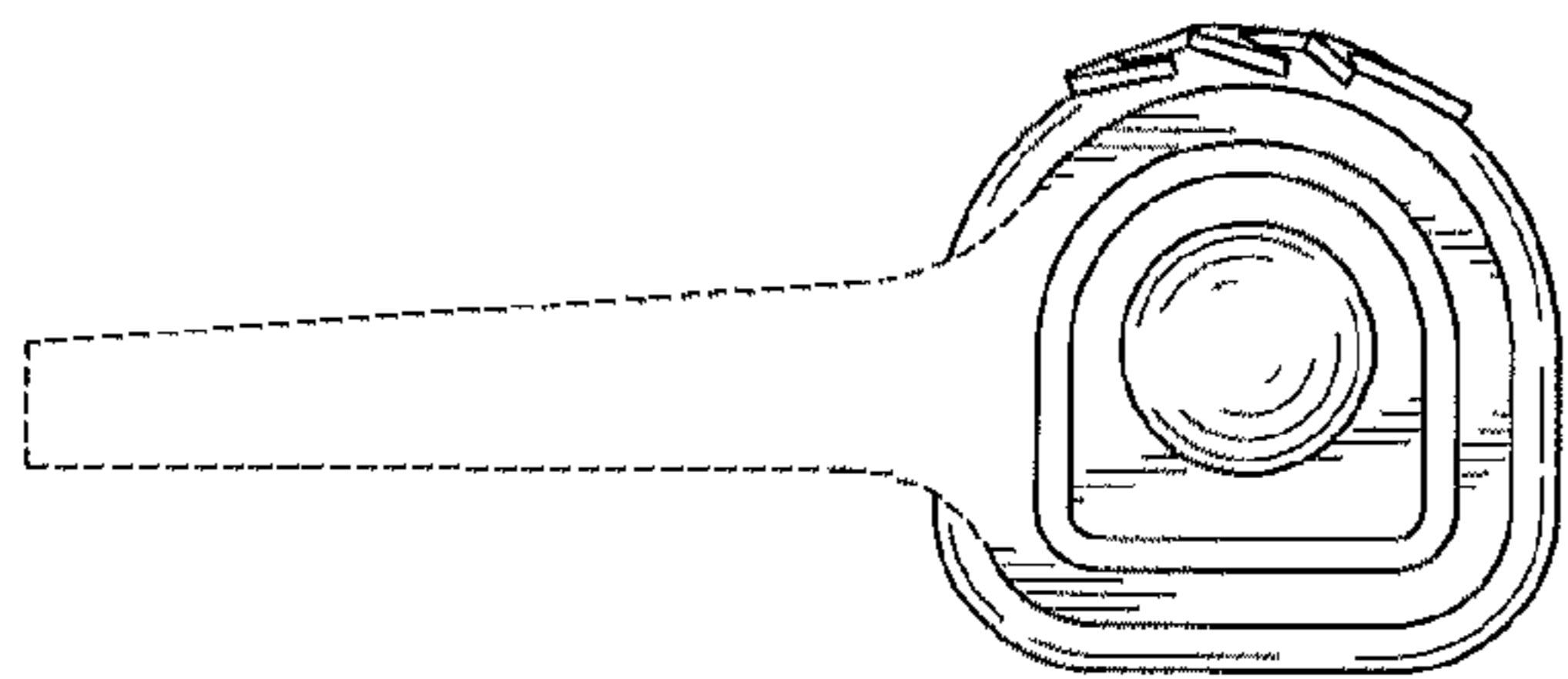

Fig. 12

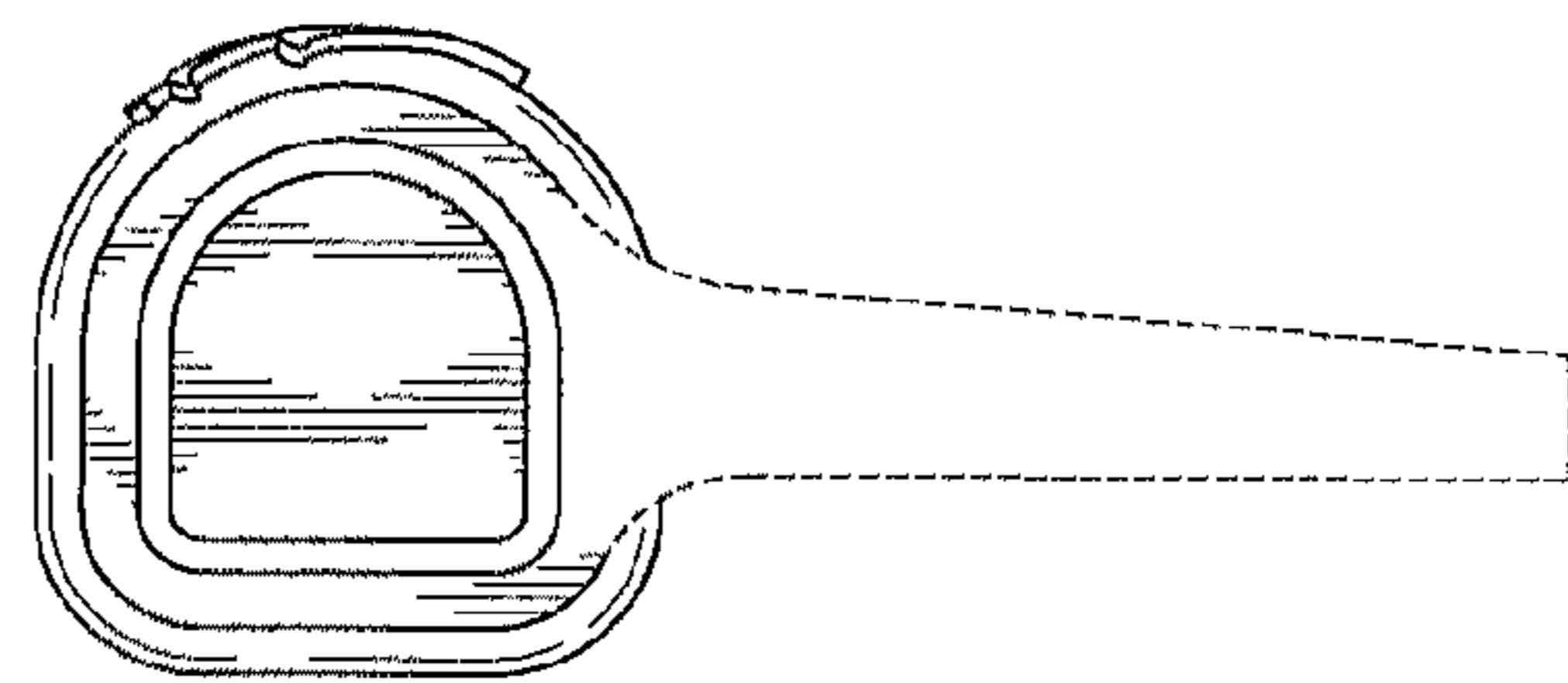

Fig. 13

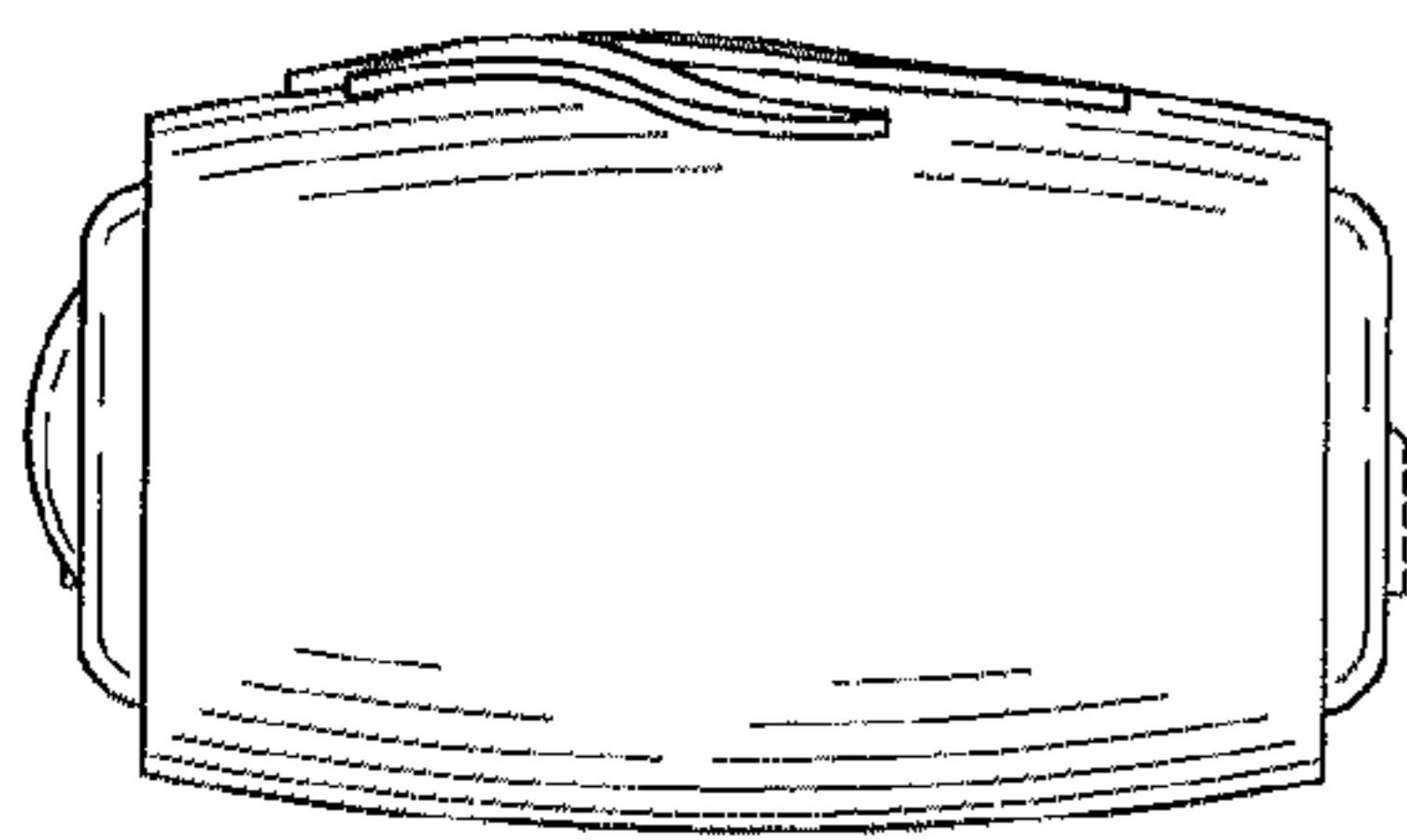

Fig. 14

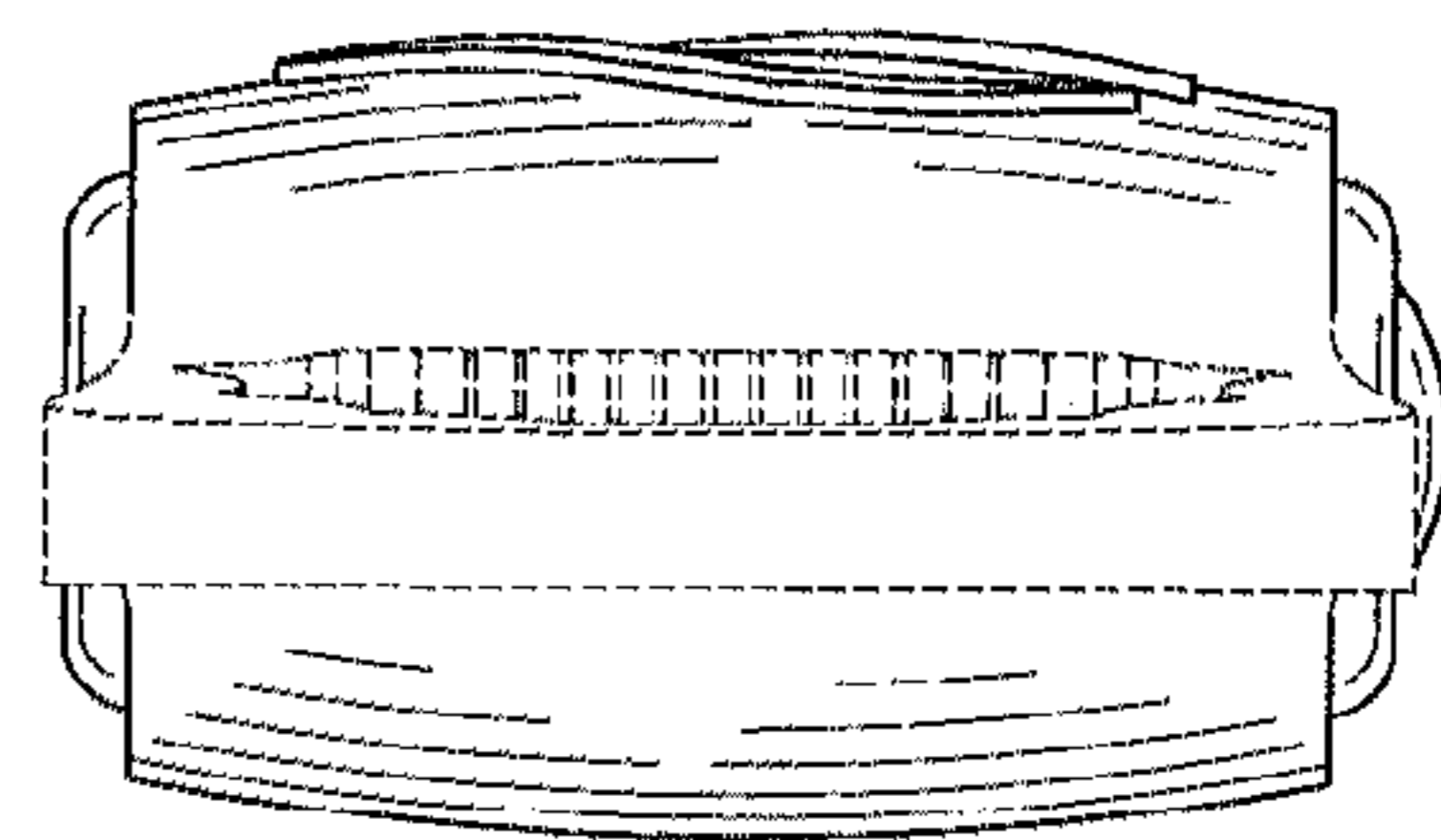

Fig. 15

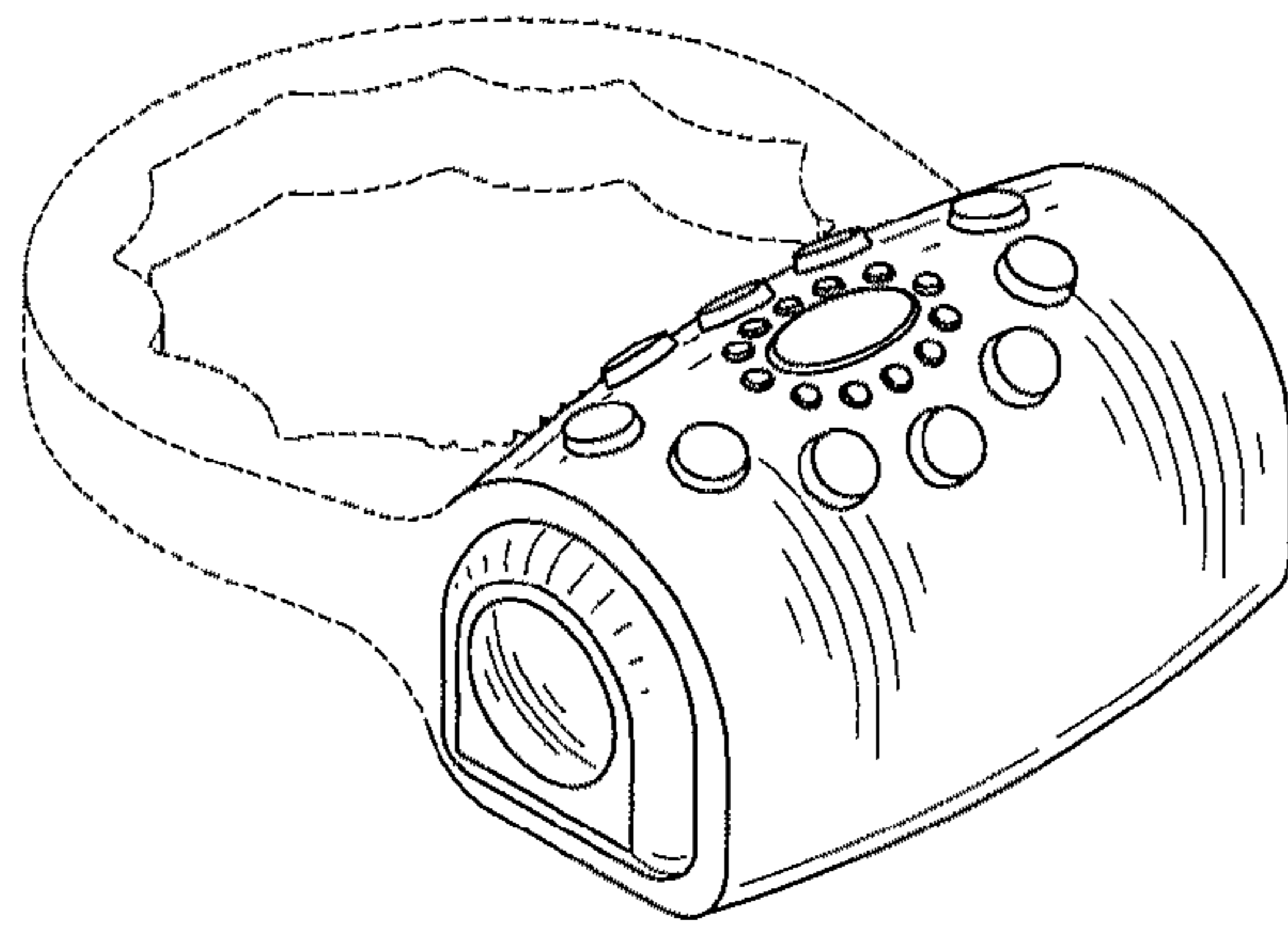

Fig. 16

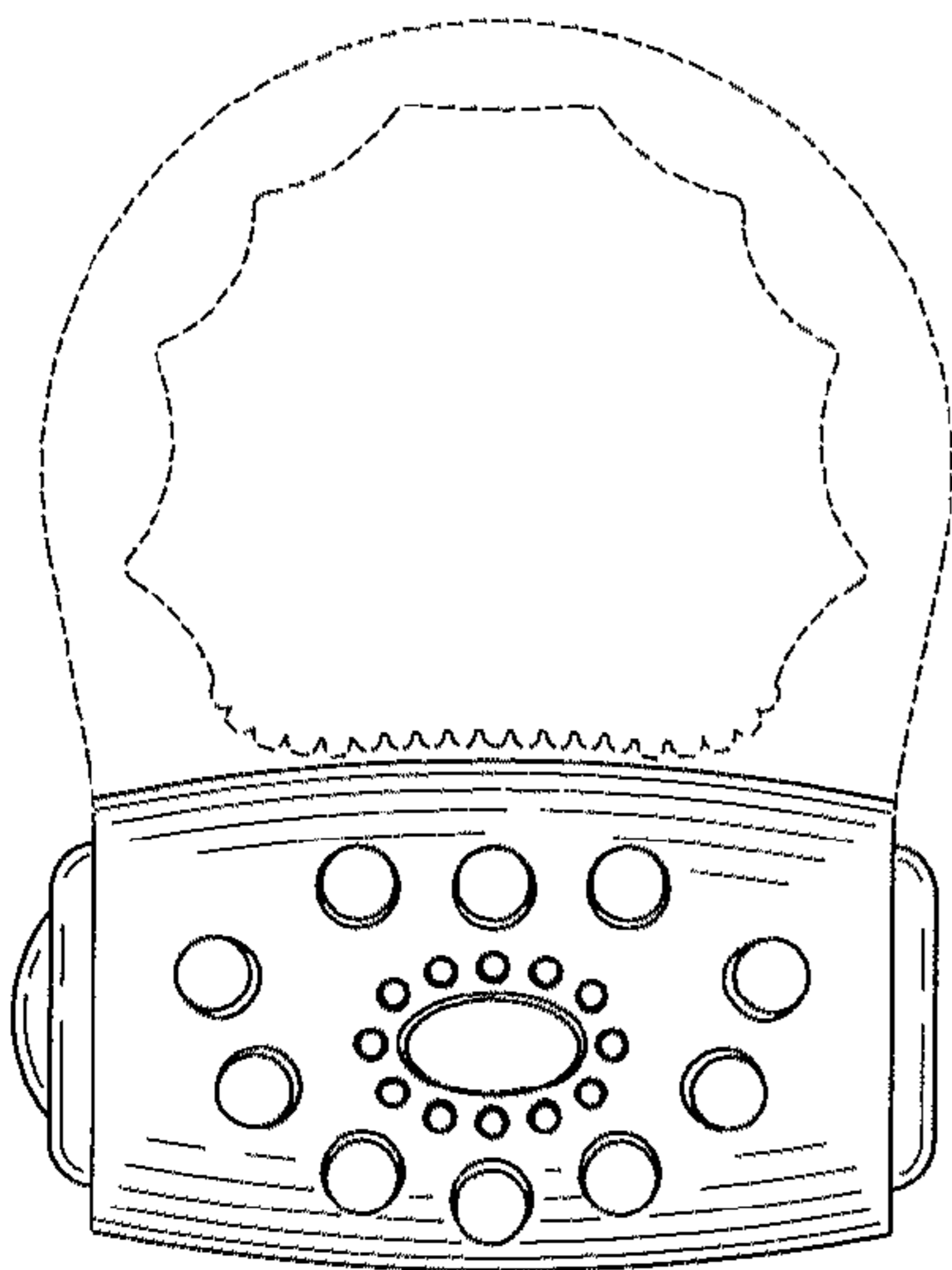

Fig. 17

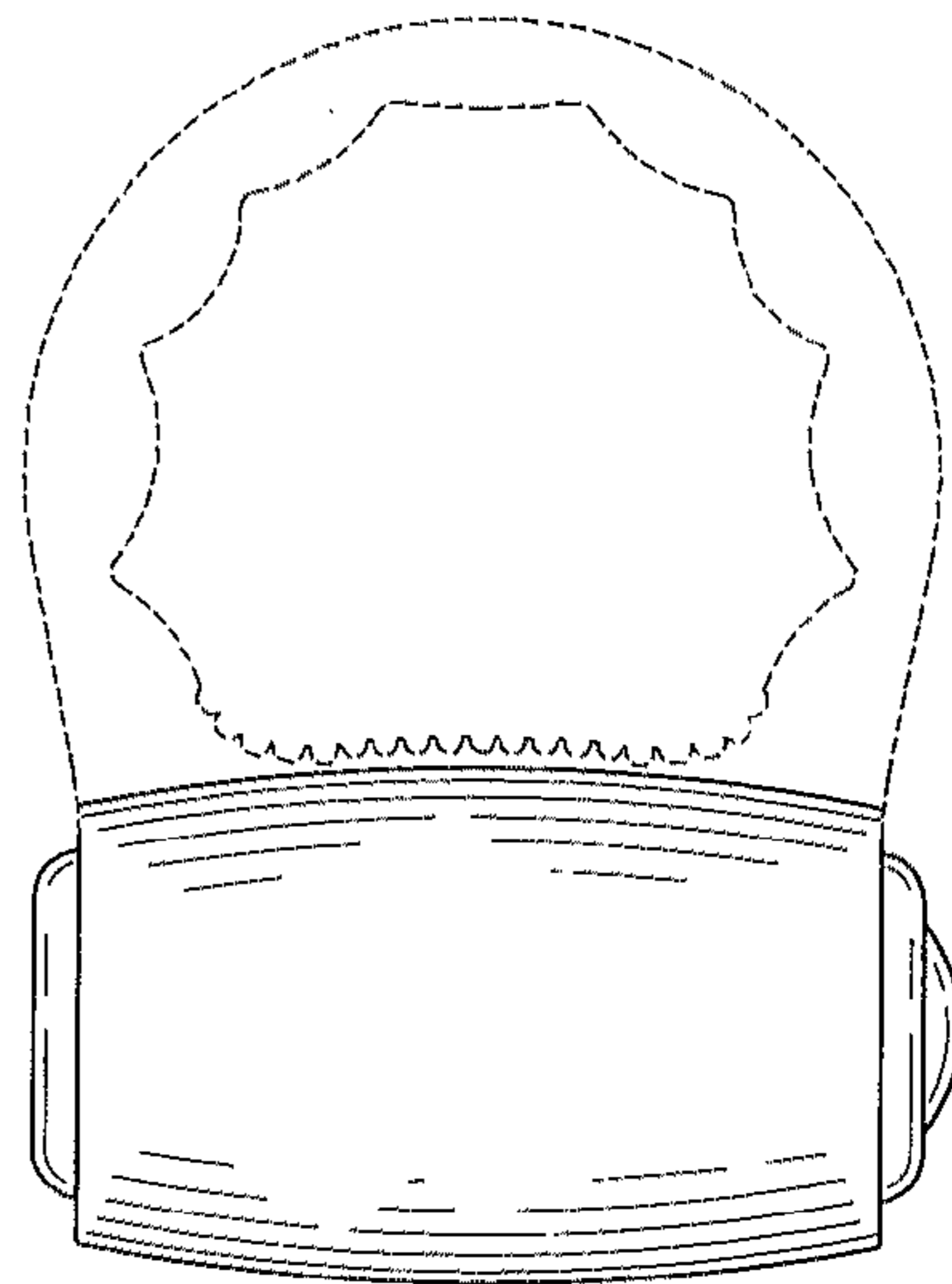

Fig. 18

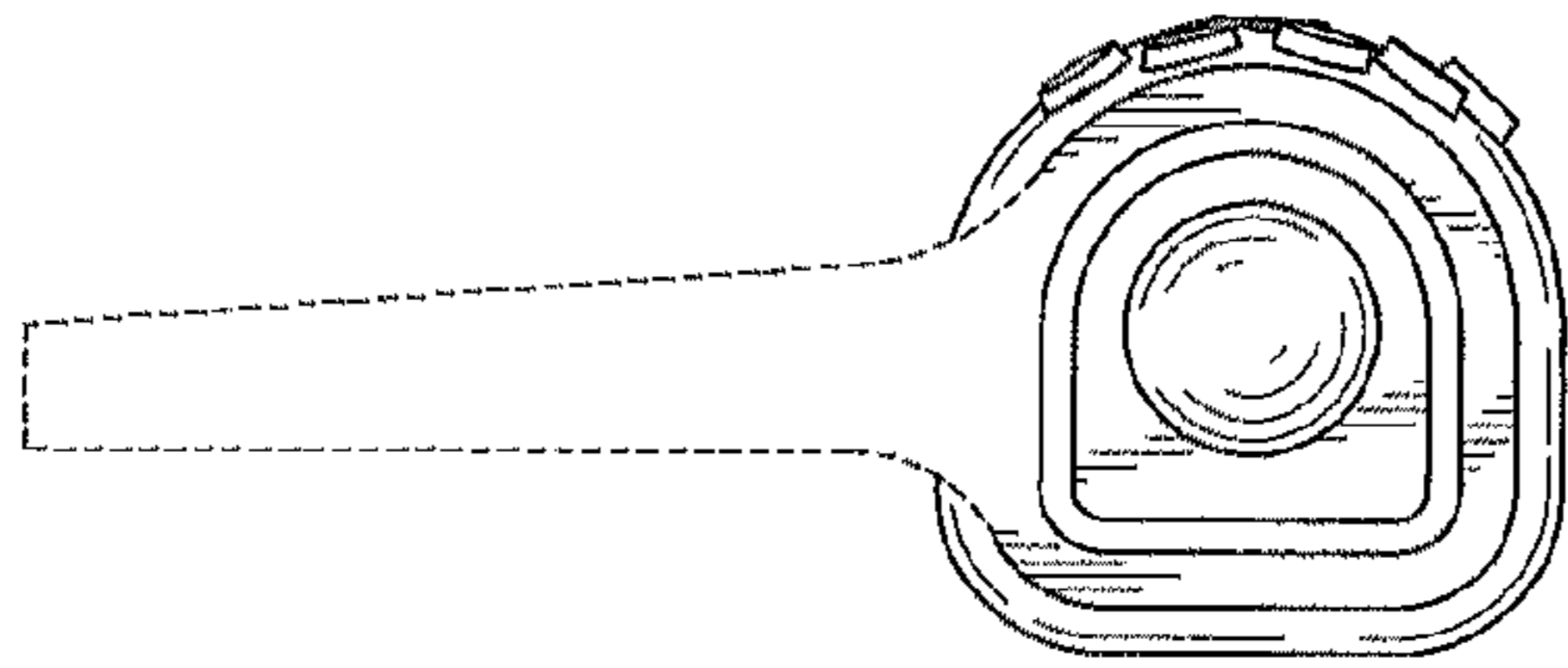

Fig. 19

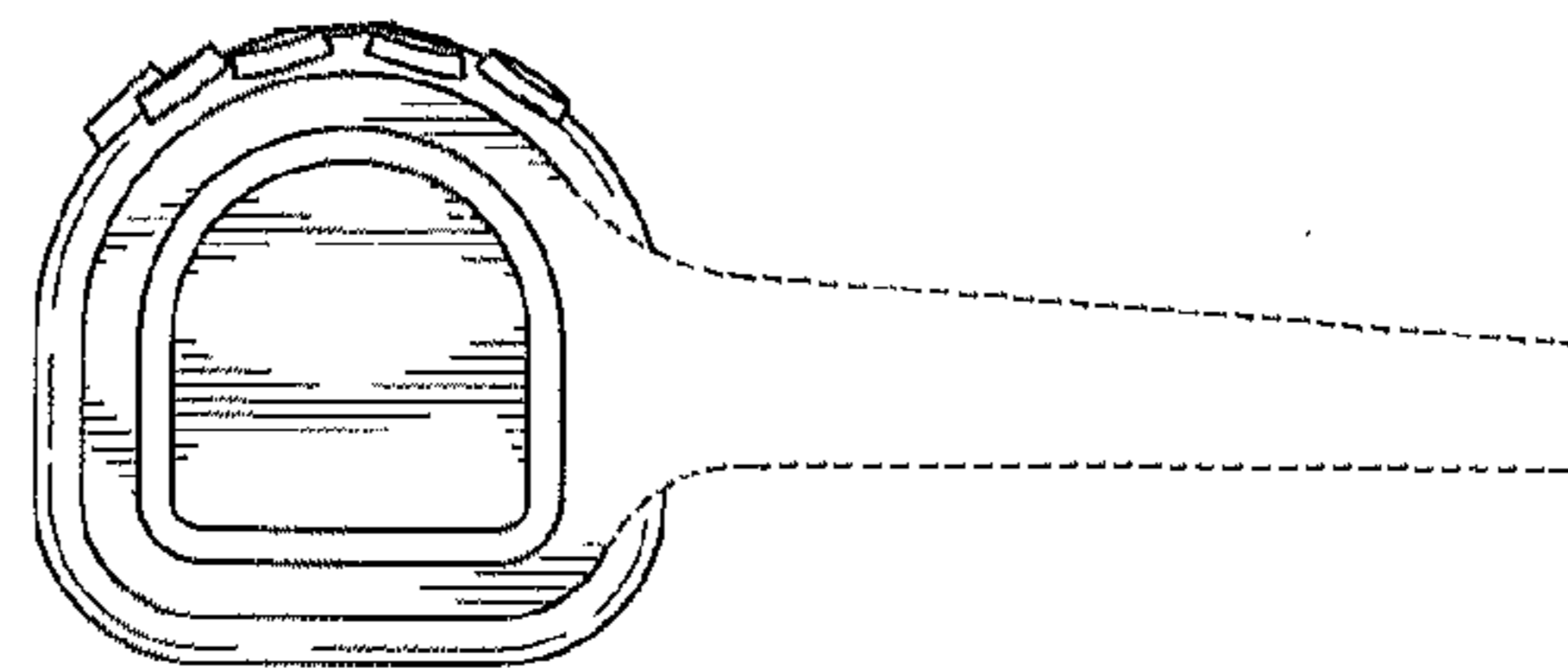

Fig. 20

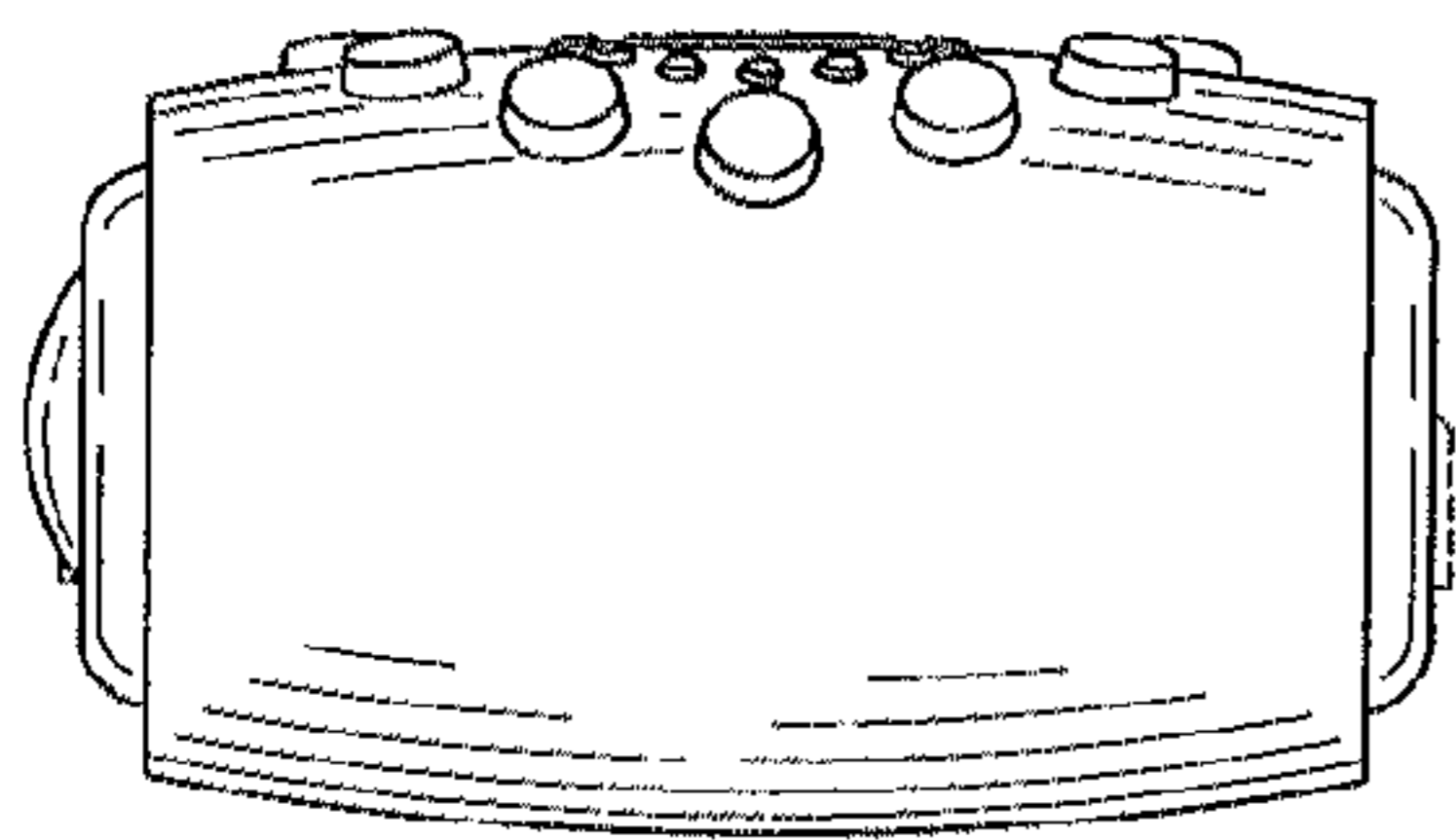

Fig. 21

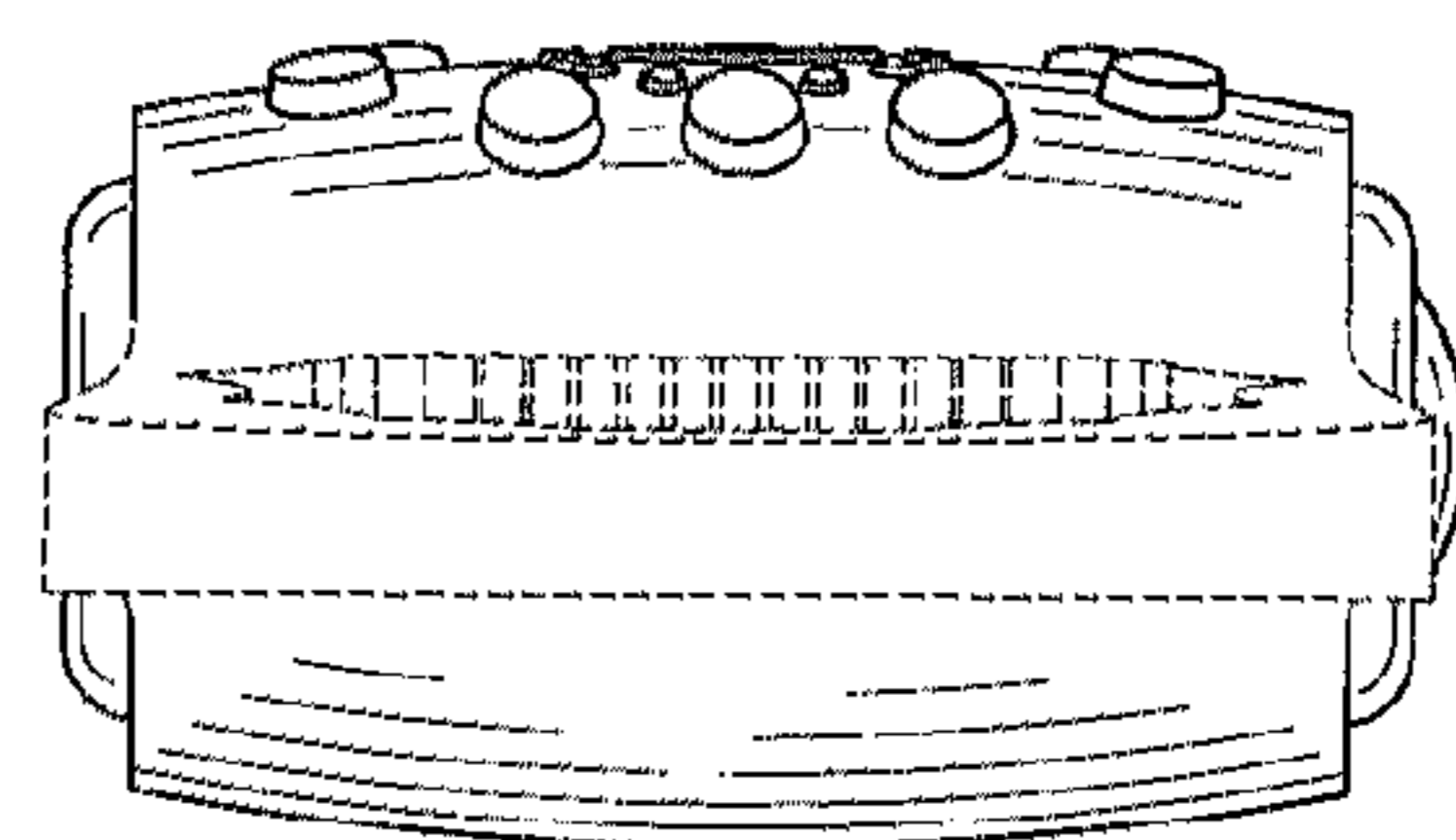

Fig. 22

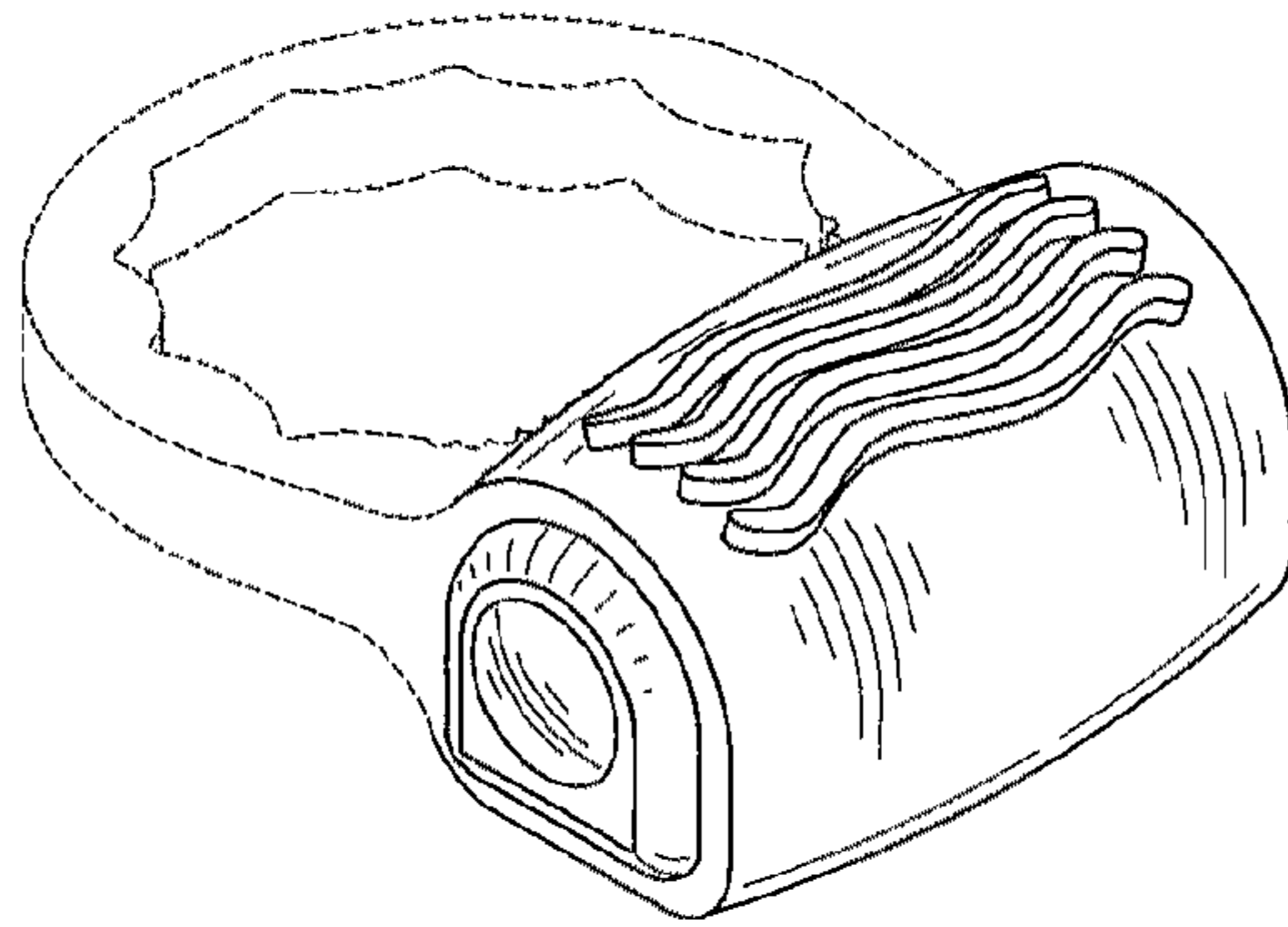

Fig. 23

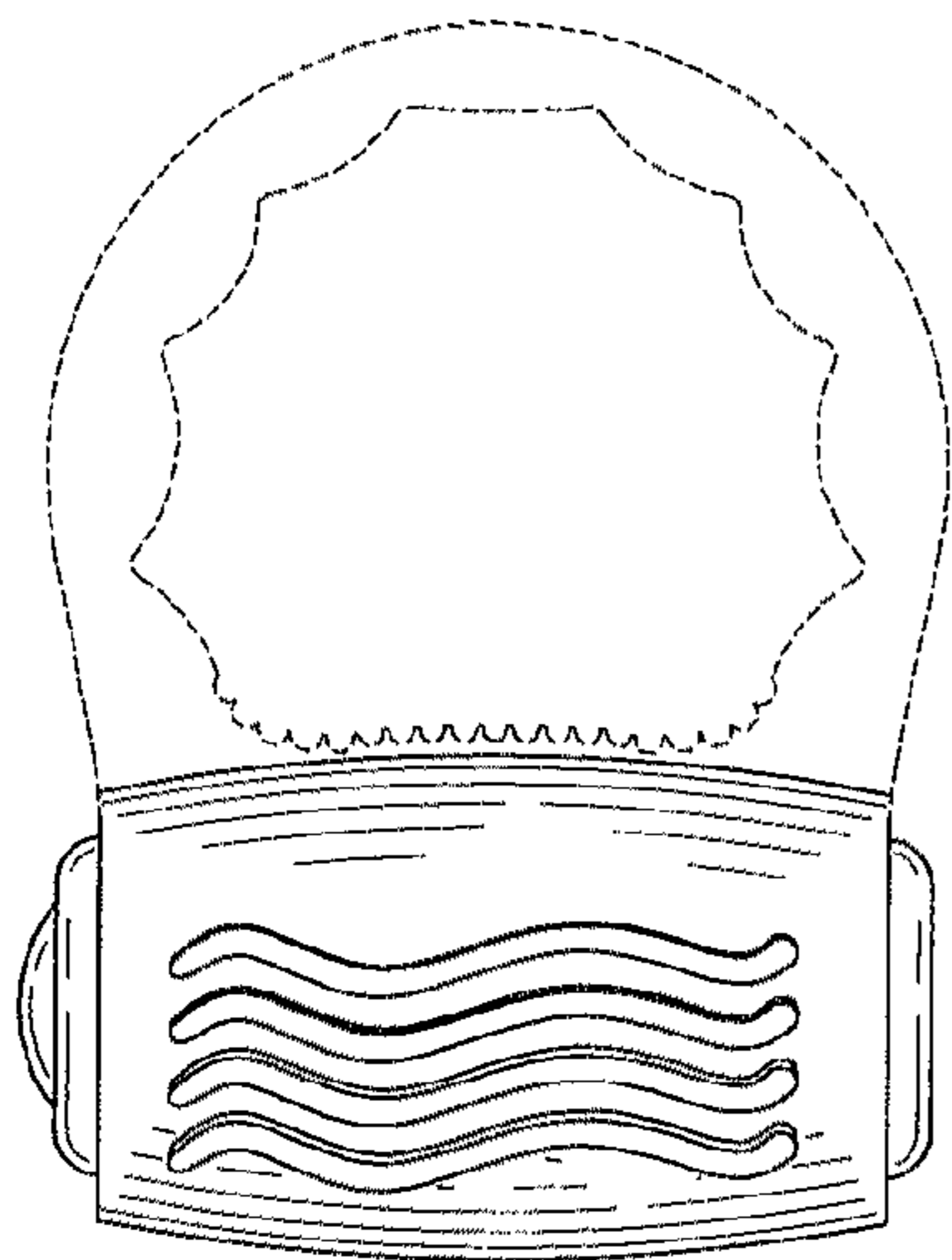

Fig. 24

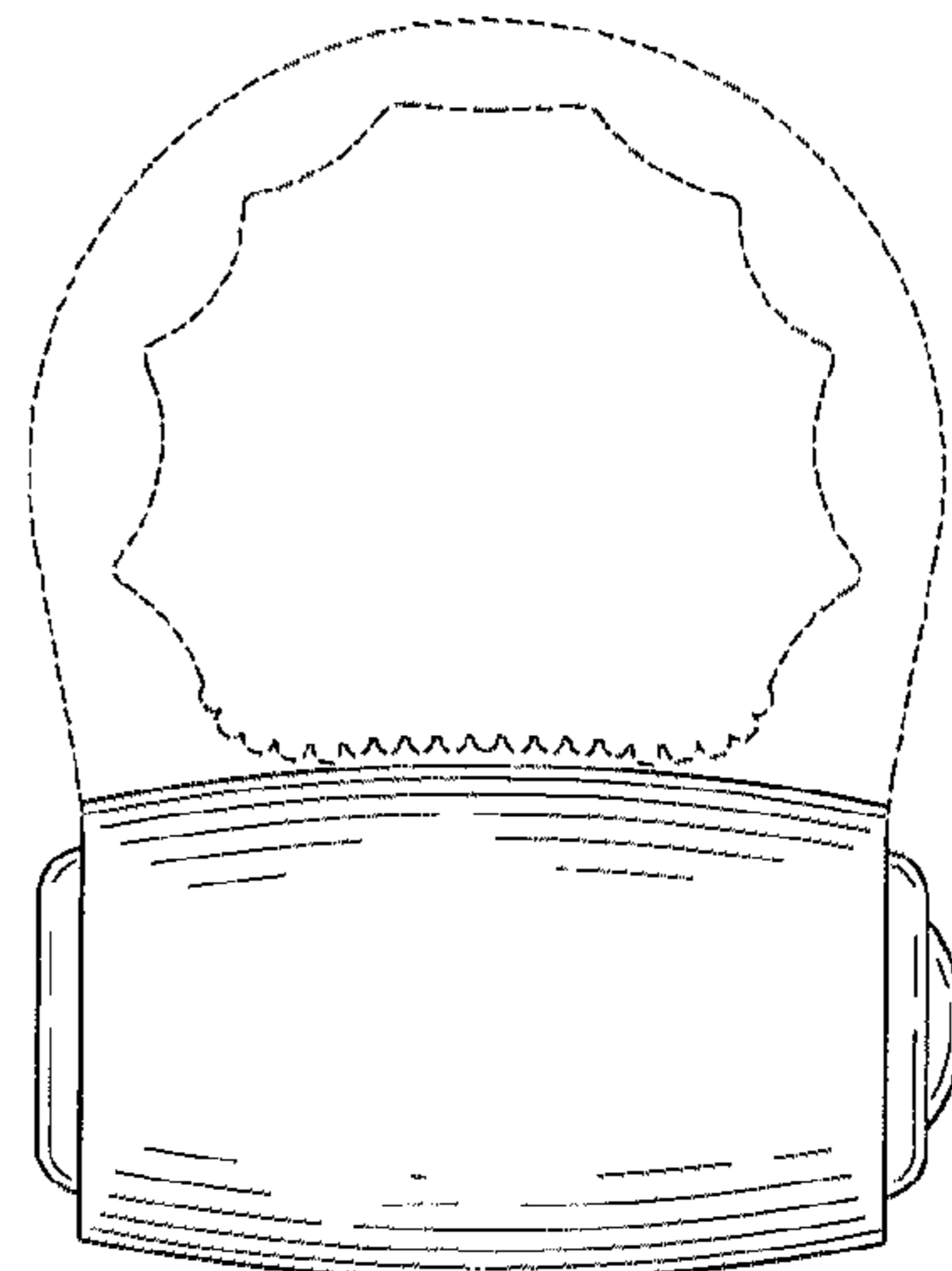

Fig. 25

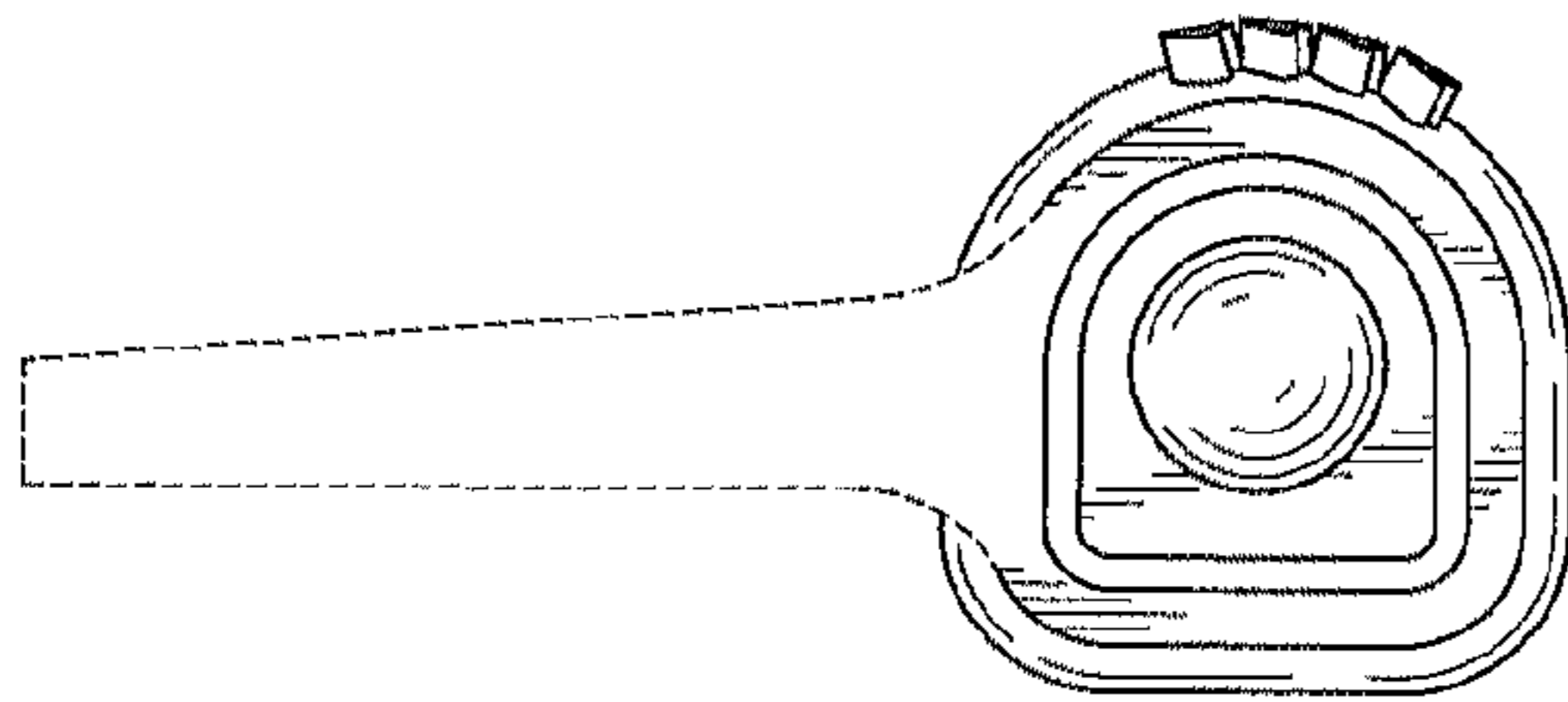

Fig. 26

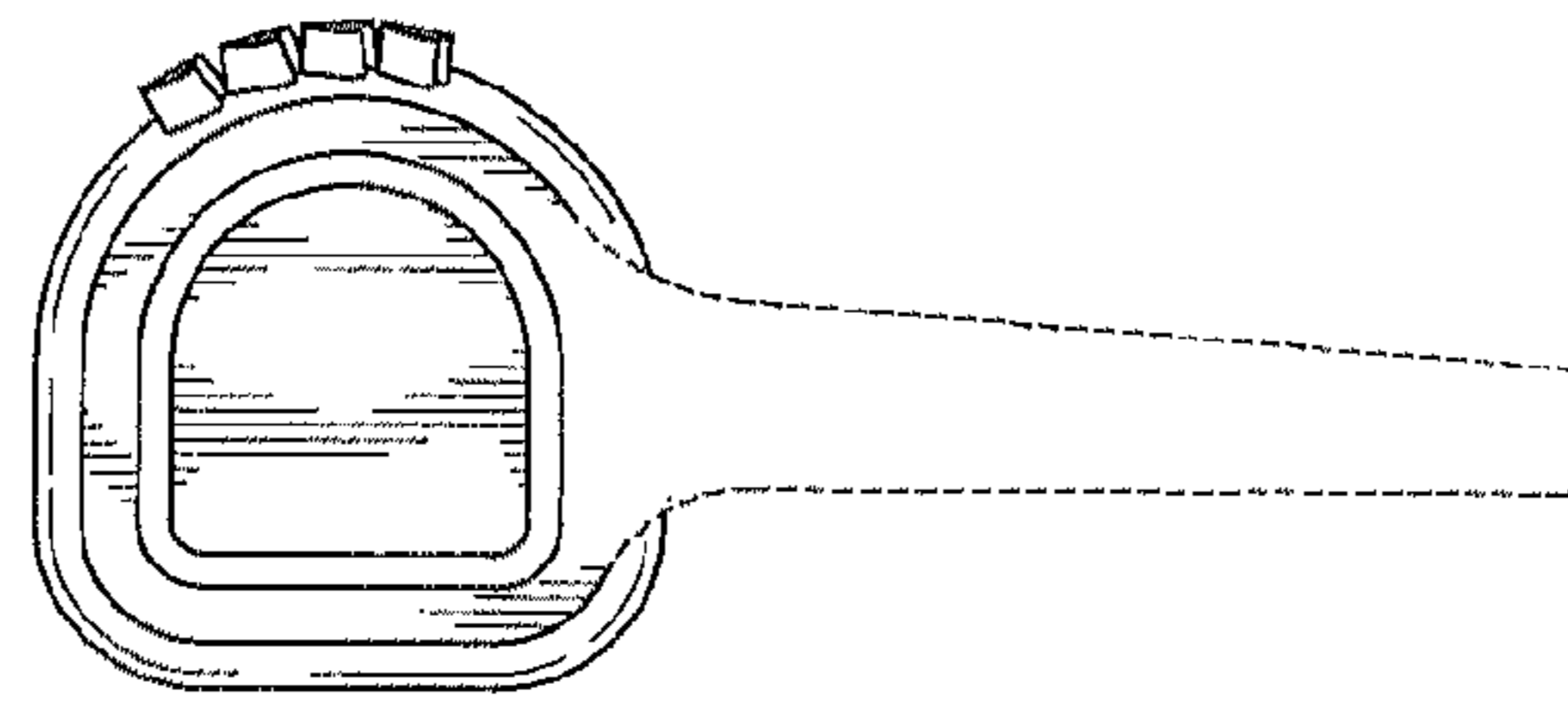

Fig. 27

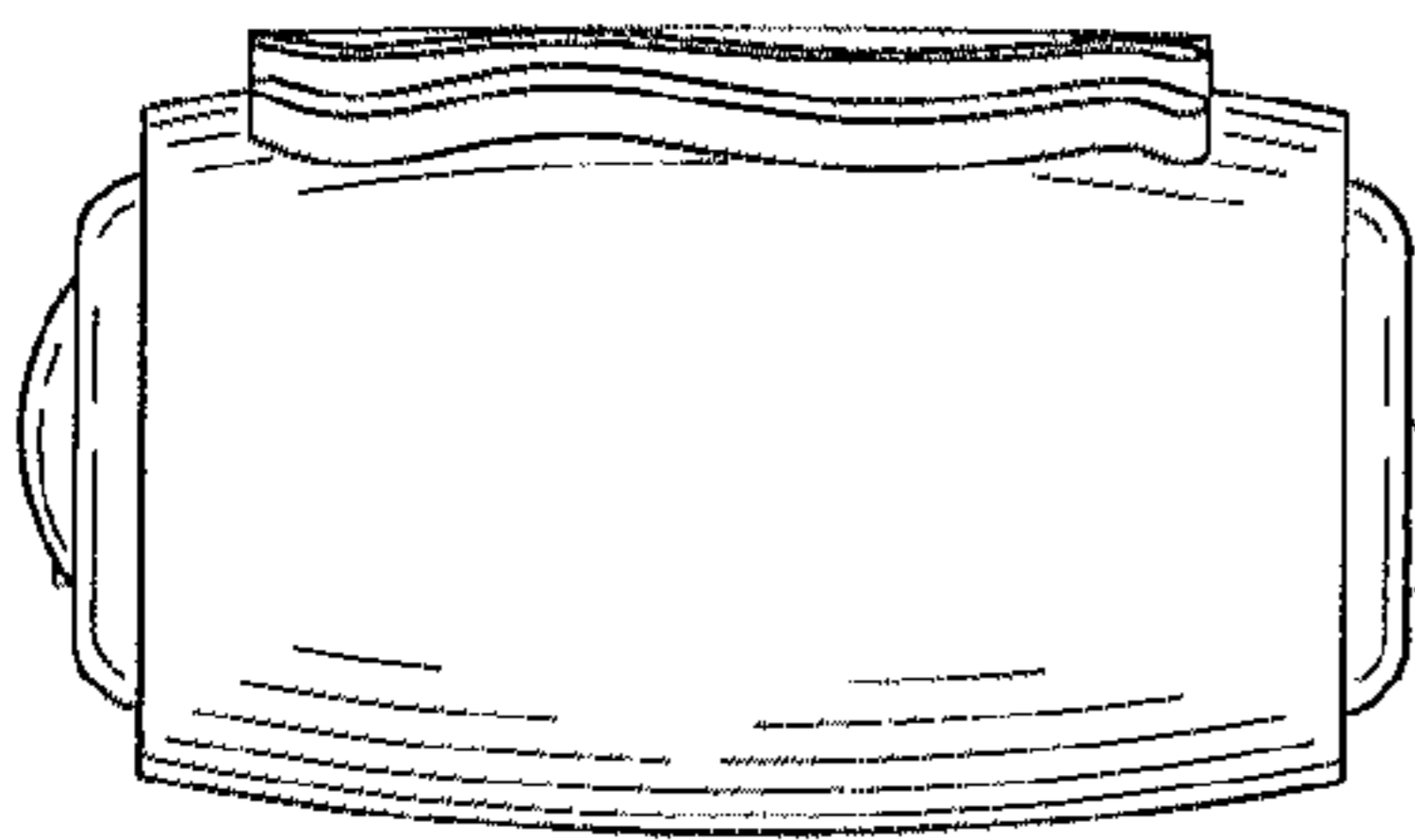

Fig. 28

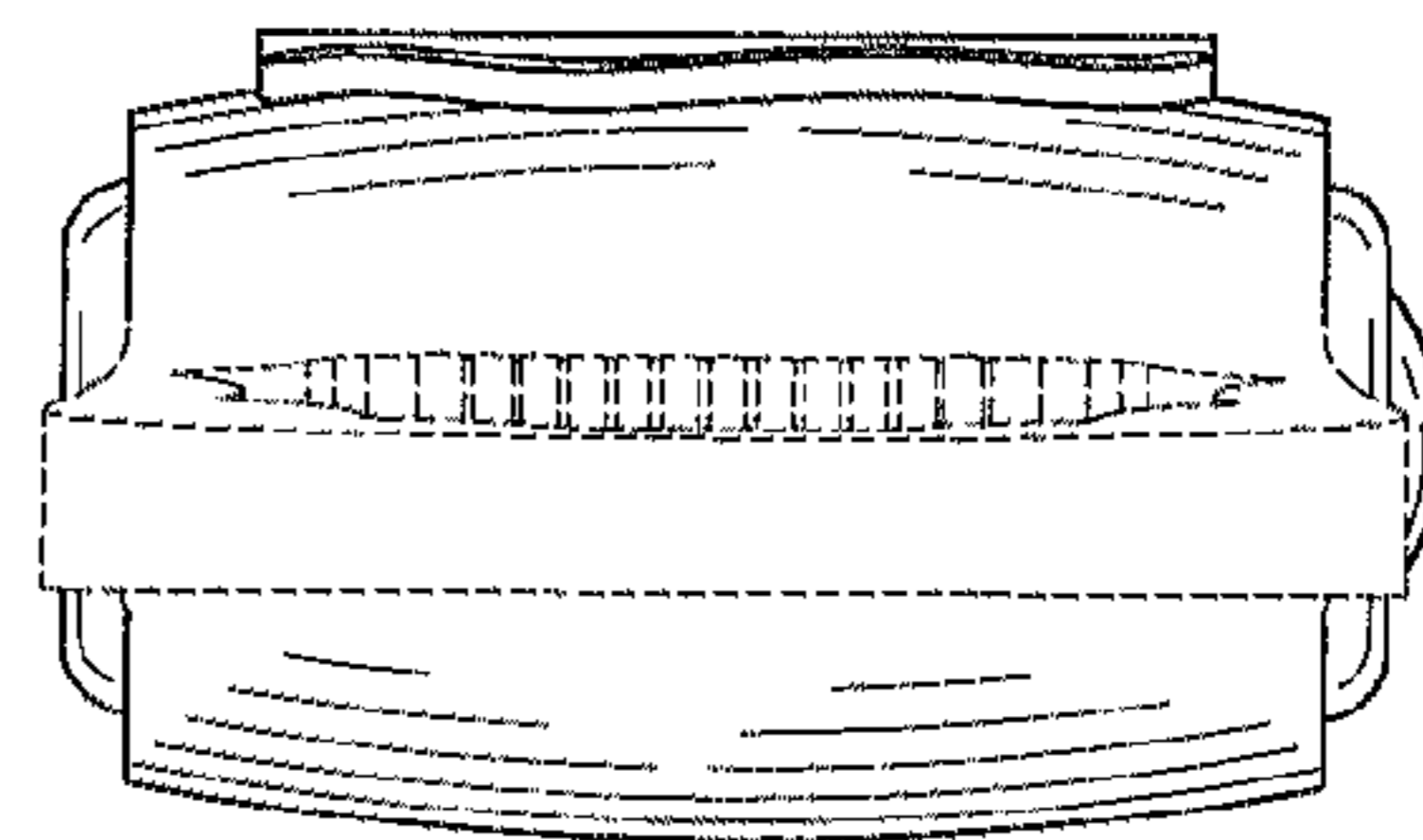

Fig. 29

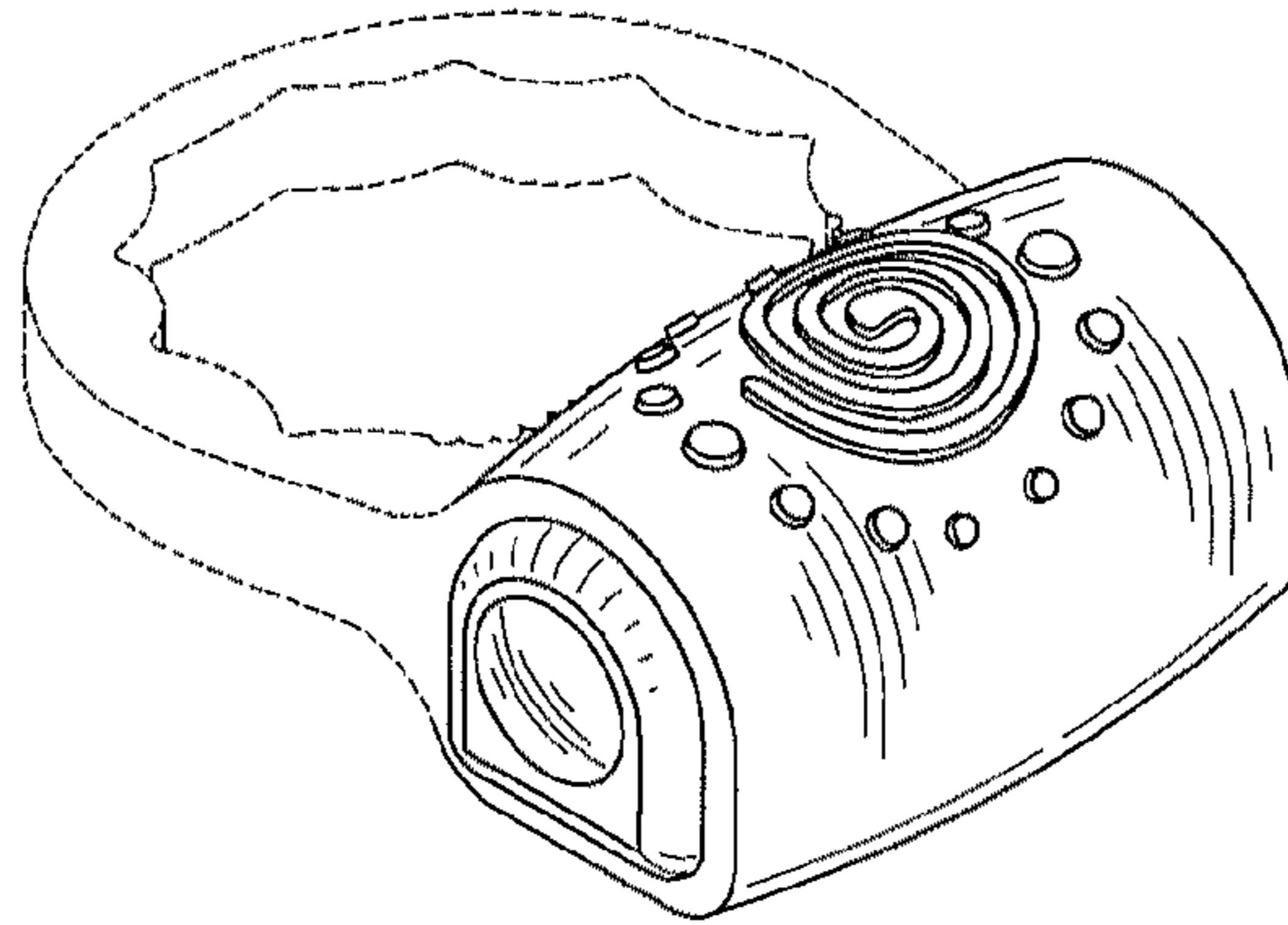

Fig. 30

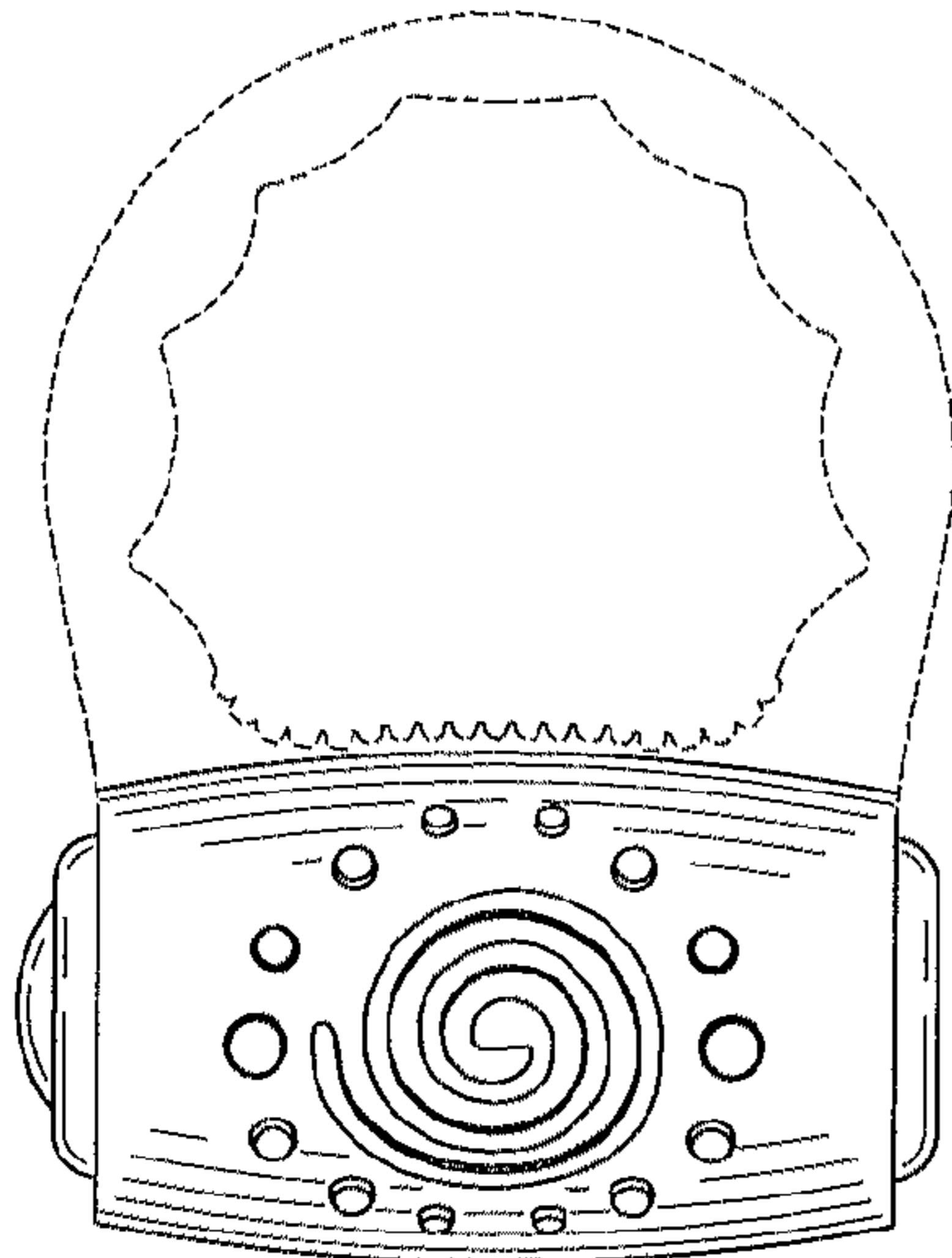

Fig. 31

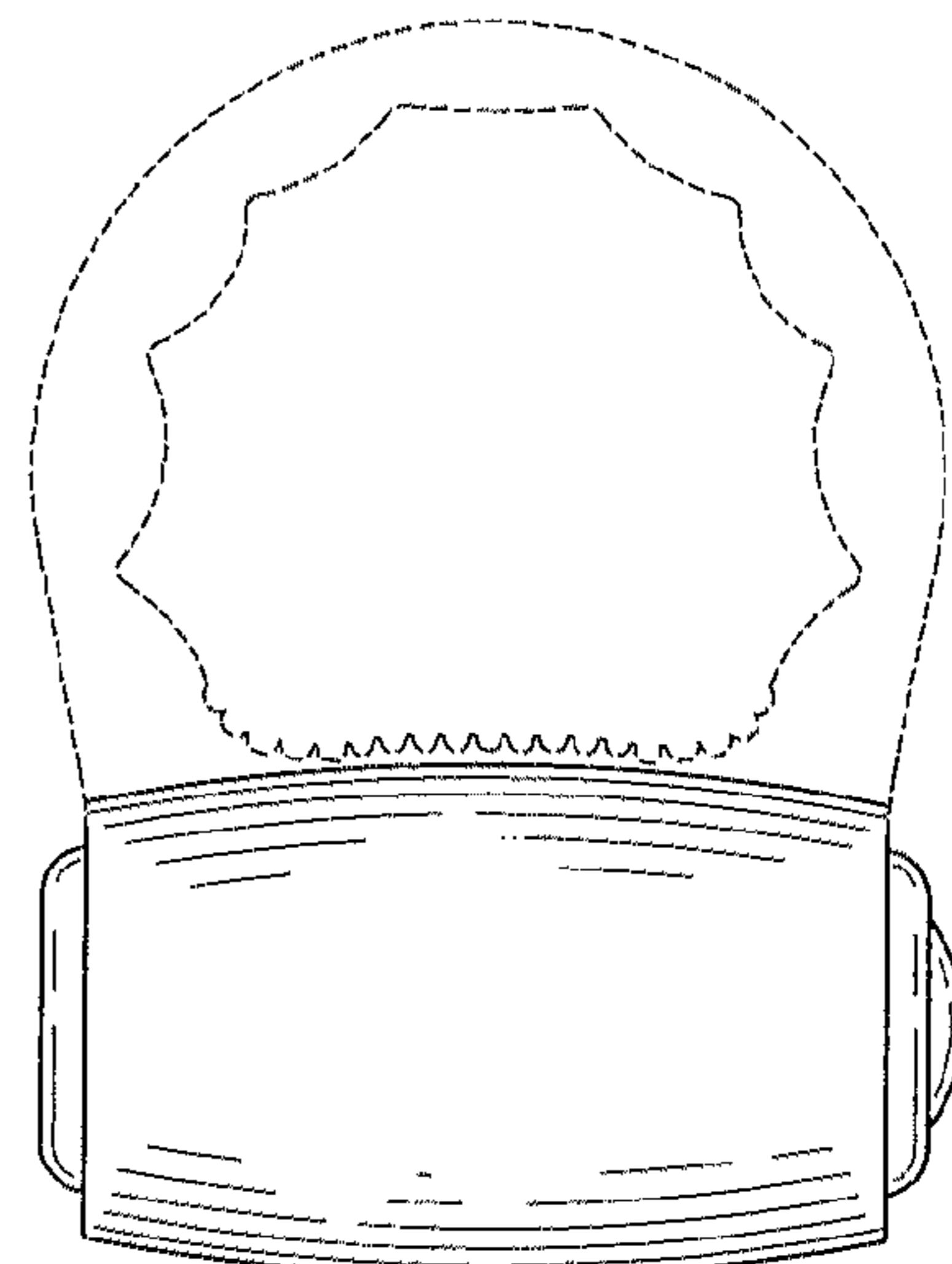

Fig. 32

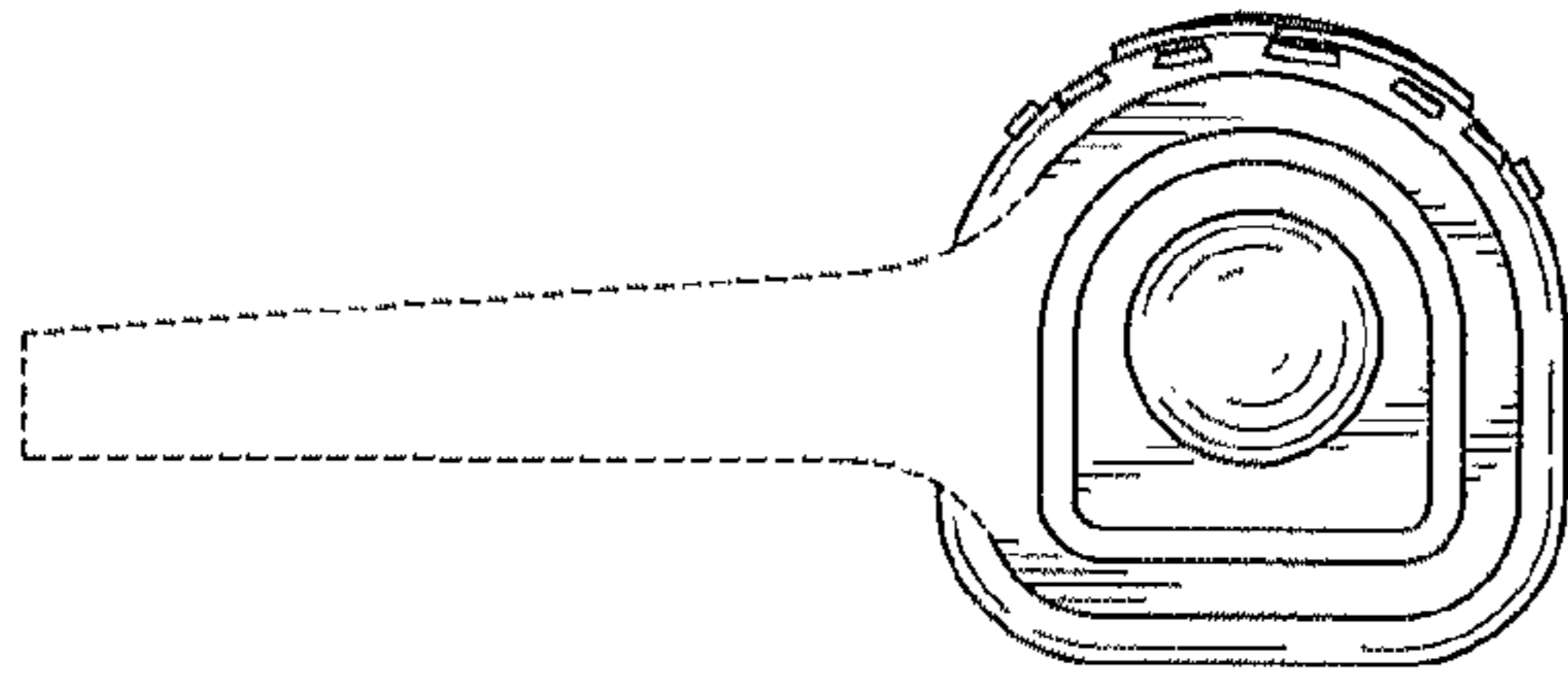

Fig. 33

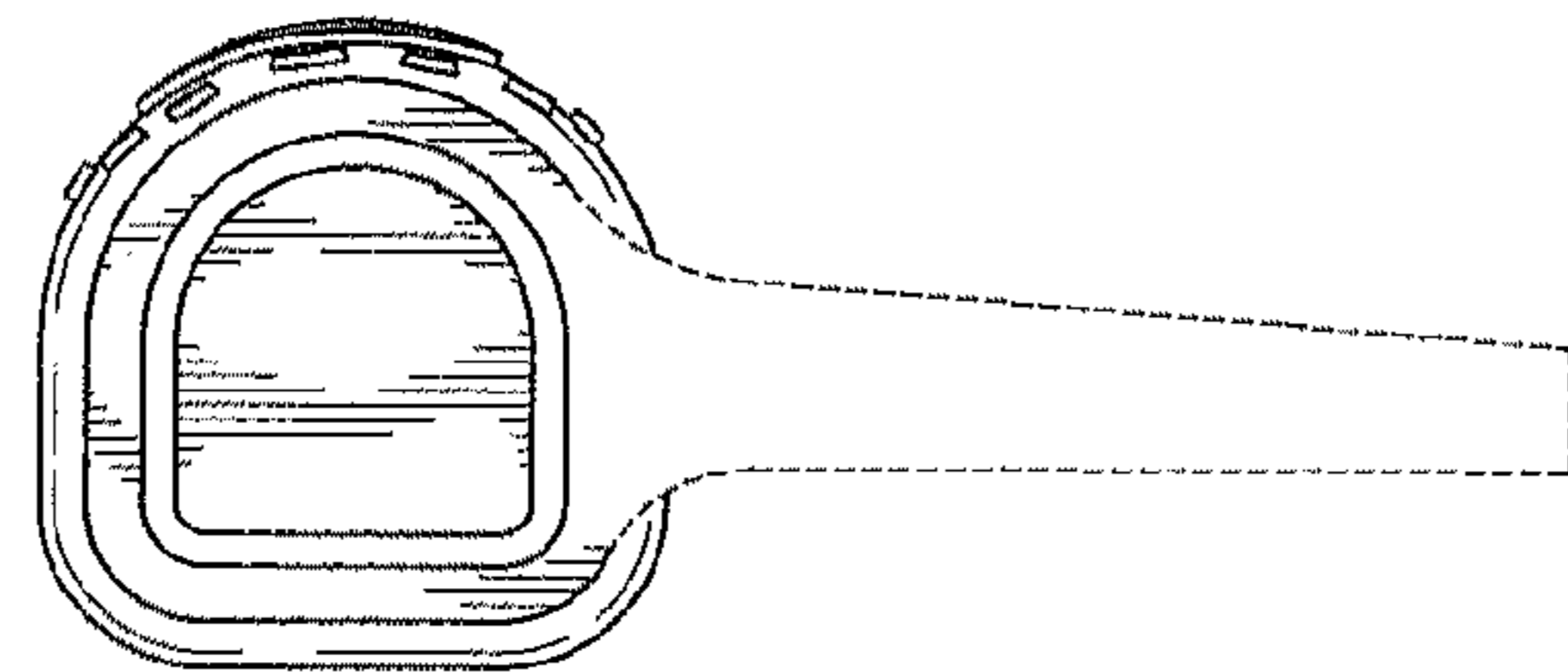

Fig. 34

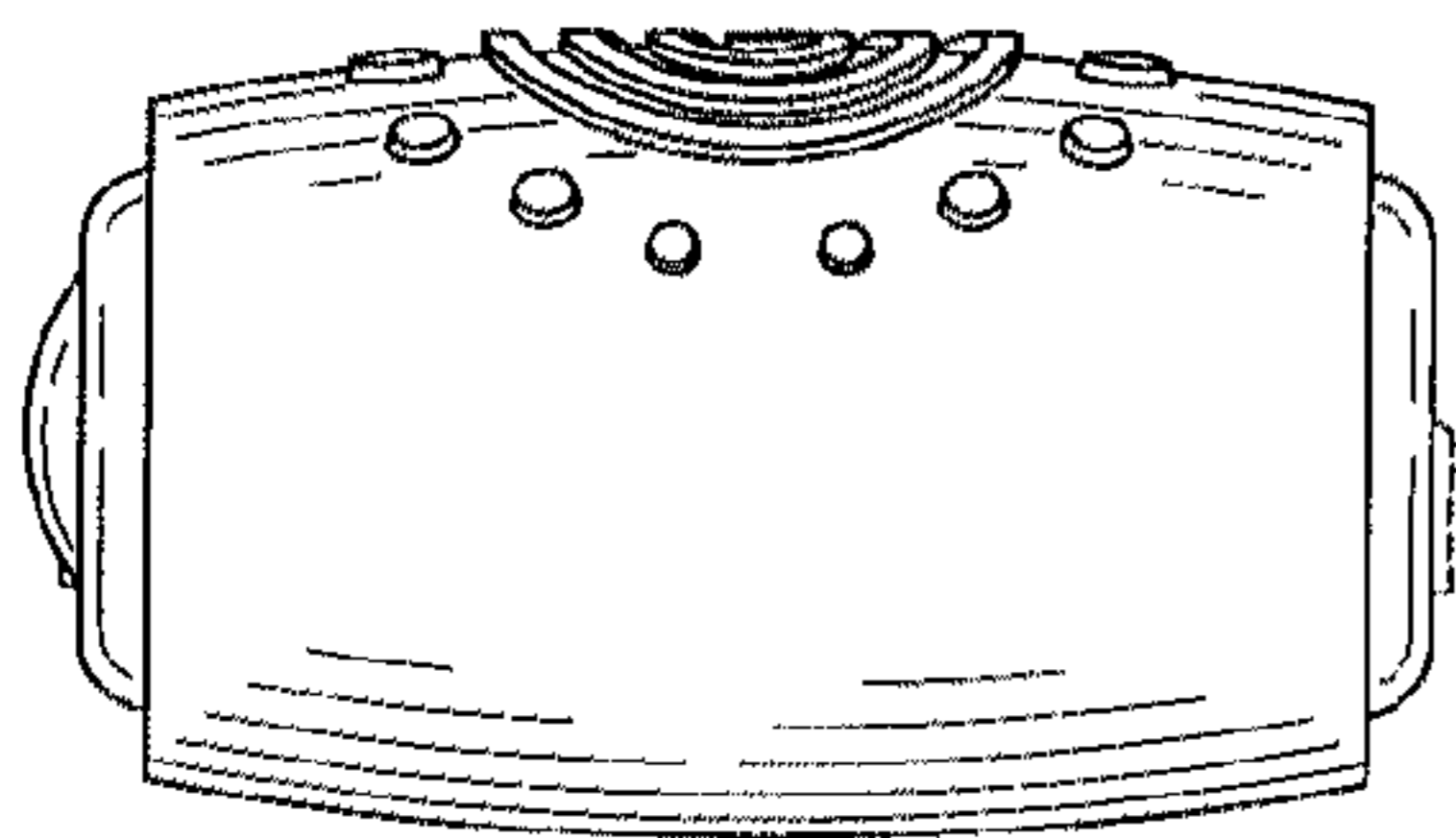

Fig. 35

