



US00D674886S

(12) **United States Design Patent**
Irwin et al.

(10) **Patent No.:** **US D674,886 S**
(45) **Date of Patent:** **** Jan. 22, 2013**

(54) **FACEPLATE FOR A DISPENSER**

Primary Examiner — Sandra Snapp

(75) Inventors: **Bryan Andrew Irwin**, Grayslake, IL (US); **Aparna Unnikrishnan**, Evanston, IL (US); **Nathan R. Westphal**, Union Grove, WI (US)

(57) **CLAIM**
The ornamental design for a faceplate for a dispenser, as shown and described.

(73) Assignee: **S.C. Johnson & Son, Inc.**, Racine, WI (US)

DESCRIPTION

(**) Term: **14 Years**

(21) Appl. No.: **29/404,361**

(22) Filed: **Oct. 19, 2011**

(51) **LOC (9) Cl.** **28-99**

(52) **U.S. Cl.** **D23/366**

(58) **Field of Classification Search** D23/355-369;
D28/5, 6; 261/DIG. 17, DIG. 42, DIG. 65,
261/DIG. 88, DIG. 89, DIG. 47, DIG. 55,
261/DIG. 70; 392/356, 390, 392, 394, 395;
239/34, 44, 53, 55, 56, 326, 60, 308

See application file for complete search history.

FIG. 1 is an isometric view of a front, top, and left side of an ornamental design for a first embodiment of a faceplate for a dispenser;
FIG. 2 is a front elevational view of the faceplate and the dispenser of FIG. 1;
FIG. 3 is a rear elevational view of the faceplate and the dispenser of FIG. 1;
FIG. 4 is a left side elevational view of the faceplate and the dispenser of FIG. 1;
FIG. 5 is a right side elevational view of the faceplate and the dispenser of FIG. 1;
FIG. 6 is a top plan view of the faceplate and the dispenser of FIG. 1;
FIG. 7 is a bottom plan view of the faceplate for a dispenser of FIG. 1;
FIG. 8 is an isometric view of a front, top, and left side of an ornamental design for a second embodiment of a faceplate for a dispenser;
FIG. 9 is a front elevational view of the faceplate for a dispenser of FIG. 8;
FIG. 10 is a rear elevational view of the faceplate for a dispenser of FIG. 8;
FIG. 11 is a left side elevational view of the faceplate for a dispenser of FIG. 8;
FIG. 12 is a right side elevational view of the faceplate for a dispenser of FIG. 8;
FIG. 13 is a top plan view of the faceplate for a dispenser of FIG. 8; and,
FIG. 14 is a bottom plan view of the faceplate for a dispenser of FIG. 8.

The broken lines are for the purpose of illustrating environmental structure and form no part of the claimed design.

(56) **References Cited**

U.S. PATENT DOCUMENTS

| | | | |
|---------------|---------|----------------|---------|
| D169,871 S | 6/1953 | Speer et al. | |
| D260,503 S | 9/1981 | Stangarone | |
| D269,838 S | 7/1983 | Altonaga | |
| D271,359 S | 11/1983 | Le | |
| D275,223 S | 8/1984 | Marxen | |
| D275,700 S | 9/1984 | Marxen | |
| D279,146 S | 6/1985 | McCaffrey | |
| D288,003 S | 1/1987 | Hoyt | |
| D296,957 S | 8/1988 | Gordon et al. | |
| 4,849,606 A * | 7/1989 | Martens et al. | 392/390 |
| D305,703 S | 1/1990 | Wang | |

(Continued)

FOREIGN PATENT DOCUMENTS

AU 124558 9/1995

(Continued)

1 Claim, 10 Drawing Sheets

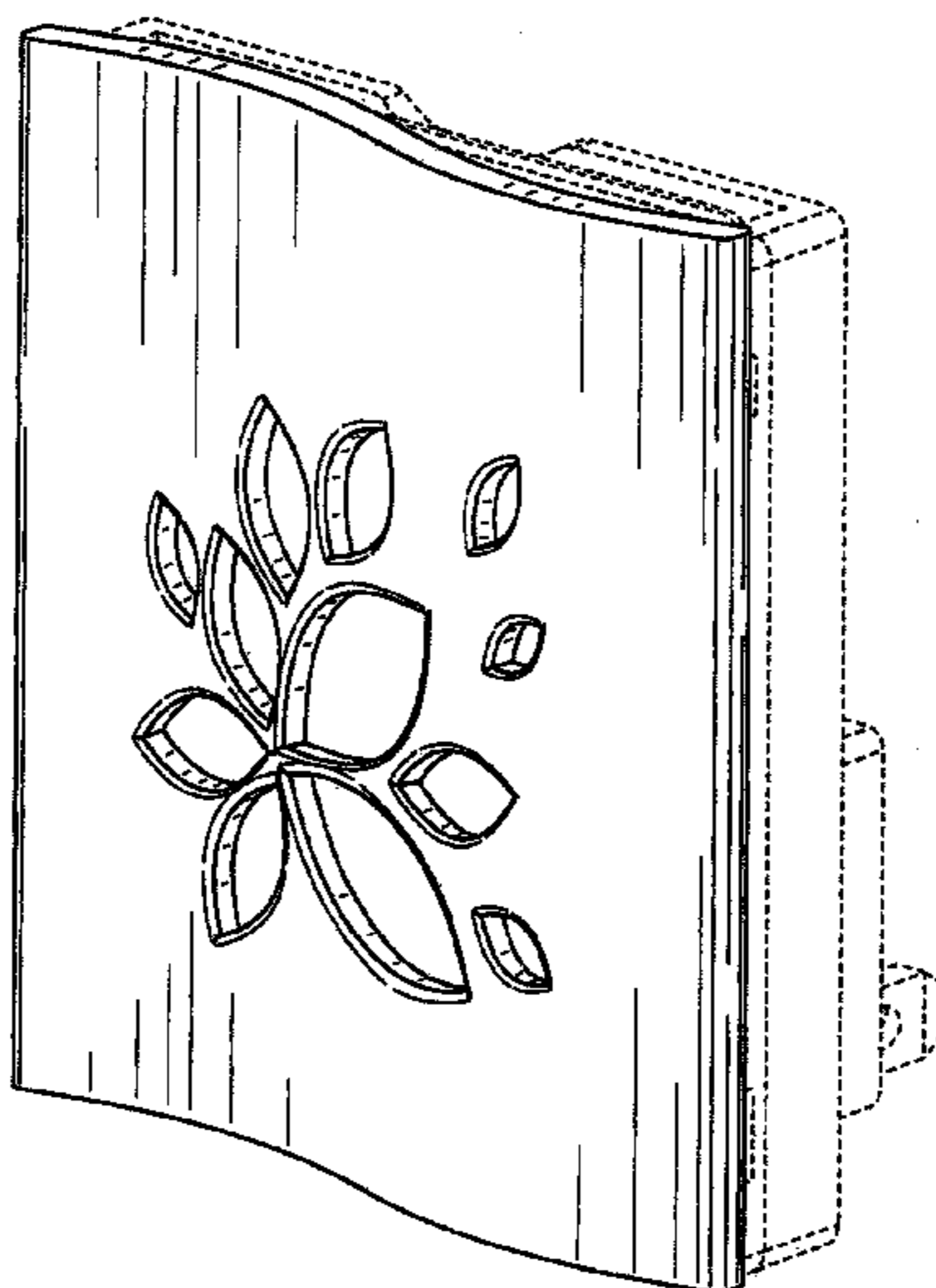

US D674,886 S

U.S. PATENT DOCUMENTS

| | | | |
|--------------|-----------|---------------------|---------|
| D323,554 S | 1/1992 | Hoyt et al. | |
| D325,077 S | 3/1992 | Kearnes | |
| D332,138 S | * 12/1992 | Lonker et al. | D23/366 |
| D339,238 S | 9/1993 | Hamilton | |
| D339,242 S | 9/1993 | Sontag et al. | |
| D346,068 S | 4/1994 | White | |
| D346,856 S | 5/1994 | Kany | |
| D349,157 S | 7/1994 | Rymer | |
| D350,209 S | * 8/1994 | Martin | D26/26 |
| D354,627 S | 1/1995 | Rowan | |
| D358,037 S | 5/1995 | Monroe | |
| D360,461 S | 7/1995 | Gillespie | |
| D361,896 S | 9/1995 | Bramley et al. | |
| D366,107 S | 1/1996 | Shaffer | |
| D366,521 S | 1/1996 | Wijaranakula | |
| D369,473 S | 5/1996 | Gluck | |
| D372,797 S | 8/1996 | Ilaria et al. | |
| D373,822 S | * 9/1996 | Leonard et al. | D23/366 |
| D374,713 S | 10/1996 | Ford et al. | |
| D374,777 S | 10/1996 | Agam | |
| D376,002 S | 11/1996 | Upson | |
| D376,420 S | 12/1996 | Rymer | |
| D376,914 S | 12/1996 | Waszkiewicz, III | |
| D377,213 S | 1/1997 | Wang | |
| D379,853 S | 6/1997 | Long et al. | |
| D380,822 S | 7/1997 | Decker et al. | |
| D383,613 S | 9/1997 | Handler | |
| D384,408 S | 9/1997 | Foreman | |
| D384,821 S | 10/1997 | Sugar | |
| D392,031 S | 3/1998 | Miller | |
| D395,705 S | 6/1998 | Ediger et al. | |
| D396,275 S | 7/1998 | Pearson | |
| D399,298 S | 10/1998 | Whitehead | |
| D401,767 S | 12/1998 | Leung | |
| D402,746 S | 12/1998 | Clark et al. | |
| D405,473 S | 2/1999 | Tikhonski et al. | |
| D405,961 S | 2/1999 | Stangl et al. | |
| D407,477 S | 3/1999 | Chen | |
| D407,809 S | 4/1999 | Hammond | |
| D411,001 S | 6/1999 | Pinchuk | |
| D414,656 S | 10/1999 | Richmond | |
| D424,812 S | 5/2000 | Kacius | |
| D431,075 S | 9/2000 | Barraclough | |
| D435,097 S | 12/2000 | Huang | |
| D435,100 S | 12/2000 | Pesu et al. | |
| D437,404 S | 2/2001 | Wu | |
| D438,607 S | 3/2001 | Edwards et al. | |
| D439,964 S | 4/2001 | Wu | |
| D441,441 S | 5/2001 | Upson | |
| D445,262 S | 7/2001 | Rowan | |
| D456,070 S | 4/2002 | Garman | |
| D456,620 S | 5/2002 | Vincent | |
| D456,886 S | 5/2002 | Hart et al. | |
| D456,888 S | 5/2002 | Buthier | |
| D457,230 S | 5/2002 | Huang | |
| D461,006 S | 7/2002 | Buthier | |
| D461,393 S | 8/2002 | Aubert Capella | |
| D465,567 S | 11/2002 | Choi | |
| D466,204 S | 11/2002 | Wolpert et al. | |
| D466,205 S | 11/2002 | Garcia | |
| D468,033 S | 12/2002 | Warren et al. | |
| D476,726 S | 7/2003 | Rosenberg | |
| D479,742 S | 9/2003 | Hollingsworth | |
| D480,221 S | 10/2003 | Luciano | |
| D481,113 S | 10/2003 | Groene et al. | |
| 6,631,852 B1 | 10/2003 | O'Leary | |
| D481,785 S | 11/2003 | Koike | |
| D485,341 S | 1/2004 | Wu | |
| D485,607 S | 1/2004 | Wu | |
| D487,308 S | 3/2004 | Engerant | |
| D488,622 S | 4/2004 | Dwiggins | |
| D498,524 S | 11/2004 | Morillas | |
| D498,525 S | 11/2004 | Harbutt et al. | |
| D498,526 S | 11/2004 | Emrich | |
| D498,836 S | 11/2004 | Morillas | |
| D503,974 S | 4/2005 | Morillas | |
| D504,500 S | 4/2005 | Morillas | |
| D508,285 S | 8/2005 | Velicescu | |

| | | | |
|------------|----------|---------------------|---------|
| D509,894 S | 9/2005 | Hoyt et al. | |
| D515,681 S | 2/2006 | Muir et al. | |
| D516,689 S | 3/2006 | Salmon et al. | |
| D518,964 S | 4/2006 | Carter et al. | |
| D520,130 S | 5/2006 | Miró | |
| D521,621 S | 5/2006 | Slater | |
| D522,640 S | 6/2006 | Miró | |
| D528,309 S | 9/2006 | Schwind | |
| D541,054 S | 4/2007 | Schwind | |
| D548,827 S | 8/2007 | Pivert et al. | |
| D552,225 S | 10/2007 | Borovicka et al. | |
| D555,478 S | 11/2007 | Miller et al. | |
| D558,870 S | 1/2008 | Triplett et al. | |
| D561,887 S | 2/2008 | Friedman et al. | |
| D573,241 S | 7/2008 | Chiu | |
| D573,706 S | 7/2008 | Zlotnik et al. | |
| D577,427 S | 9/2008 | Spiegel | |
| D578,197 S | 10/2008 | Spiegel | |
| D581,677 S | 12/2008 | Yeh | |
| D590,141 S | 4/2009 | McClaskie | |
| D600,788 S | 9/2009 | Campbell et al. | |
| D603,949 S | 11/2009 | Campbell et al. | |
| D606,185 S | 12/2009 | Wefler et al. | |
| D608,433 S | 1/2010 | Murai et al. | |
| D609,321 S | 2/2010 | Tomasulo et al. | |
| D616,740 S | 6/2010 | Akers et al. | |
| D638,531 S | * 5/2011 | Irwin et al. | D23/366 |
| D642,667 S | * 8/2011 | Irwin et al. | D23/366 |
| D662,582 S | * 6/2012 | Olchovy et al. | D23/366 |

FOREIGN PATENT DOCUMENTS

| | | |
|----|---------------|---------|
| AU | 127817 | 9/1996 |
| AU | 128464 | 10/1996 |
| AU | 128465 | 10/1996 |
| AU | 132238 | 11/1997 |
| AU | 133431 | 4/1998 |
| AU | 138445 | 9/1999 |
| AU | 139593 | 1/2000 |
| AU | 144711 | 8/2001 |
| AU | 144970 | 8/2001 |
| AU | 144983 | 8/2001 |
| AU | 150220 | 1/2003 |
| AU | 151264 | 3/2003 |
| AU | 152330 | 7/2003 |
| AU | 152331 | 7/2003 |
| AU | 152332 | 7/2003 |
| AU | 153589 | 11/2003 |
| AU | 154829 | 3/2004 |
| AU | 155668 | 6/2004 |
| AU | 300248 | 11/2004 |
| AU | 300600 | 2/2005 |
| AU | 301146 | 3/2005 |
| AU | 309626 | 9/2006 |
| AU | 309627 | 9/2006 |
| AU | 309737 | 9/2006 |
| AU | 311260 | 11/2006 |
| AU | 315944 | 9/2007 |
| AU | 315945 | 9/2007 |
| AU | 315946 | 9/2007 |
| AU | 318723 | 4/2008 |
| AU | 326307 | 6/2009 |
| AU | 329139 | 1/2010 |
| AU | 332678 | 9/2010 |
| AU | 332679 | 9/2010 |
| AU | 332682 | 9/2010 |
| AU | 333047 | 9/2010 |
| DE | M9506278-0001 | 1/1996 |
| DE | M9705311-0001 | 11/1997 |
| DE | 40104057-0001 | 1/2002 |
| DE | 40104057-0002 | 1/2002 |
| DE | 40104057-0003 | 1/2002 |
| DE | 40104057-0004 | 1/2002 |
| DE | 40302332-0001 | 9/2003 |
| DE | 40302332-0002 | 9/2003 |
| DE | 40302332-0003 | 9/2003 |
| DE | 40302332-0004 | 9/2003 |
| DE | 40302332-0005 | 9/2003 |
| DE | 40302332-0006 | 9/2003 |
| DE | 40302332-0007 | 9/2003 |

US D674,886 S

Page 3

| | | | | | |
|----|----------------|---------|----|-----------------|---------|
| DE | 40302332-0008 | 9/2003 | FR | 005700-003 | 3/2001 |
| DE | 40302332-0009 | 9/2003 | GB | 2028376 | 1/1994 |
| DE | 40302332-0010 | 9/2003 | GB | 2045032 | 6/1995 |
| DE | 40302332-0011 | 9/2003 | GB | 2043826 | 7/1995 |
| DE | 40302332-0012 | 9/2003 | GB | 2083911 | 9/1999 |
| DE | 40302332-0013 | 9/2003 | GB | 2083912 | 9/1999 |
| DE | 40302332-0014 | 9/2003 | GB | 2100214 | 9/2000 |
| EM | 000205661-0001 | 10/2004 | GB | 3007055 | 9/2003 |
| EM | 000358940-0004 | 8/2005 | JP | 1079079 | 7/2000 |
| EM | 000820352-0001 | 11/2007 | JP | 1131488 | 1/2002 |
| EM | 000820352-0002 | 11/2007 | JP | 1154856 | 10/2002 |
| EM | 000820352-0003 | 11/2007 | JP | 1212383 | 7/2004 |
| EM | 000820352-0004 | 11/2007 | JP | 1230282 | 2/2005 |
| EM | 000820352-0005 | 11/2007 | KR | 30-0202619-0000 | 7/1997 |
| EM | 000834726-0001 | 2/2008 | KR | 30-0381782-0000 | 5/2005 |
| EM | 001642026-0001 | 12/2009 | WO | DM050034 | 2/2000 |
| EM | 001740572-0005 | 10/2010 | WO | DM054925 | 3/2001 |
| EM | 001740572-0008 | 10/2010 | WO | WO 02-078750 | 10/2002 |
| FR | 973411-001 | 10/1997 | WO | DM066131 | 6/2005 |
| FR | 005700-001 | 3/2001 | | | |
| FR | 005700-002 | 3/2001 | | | |

* cited by examiner

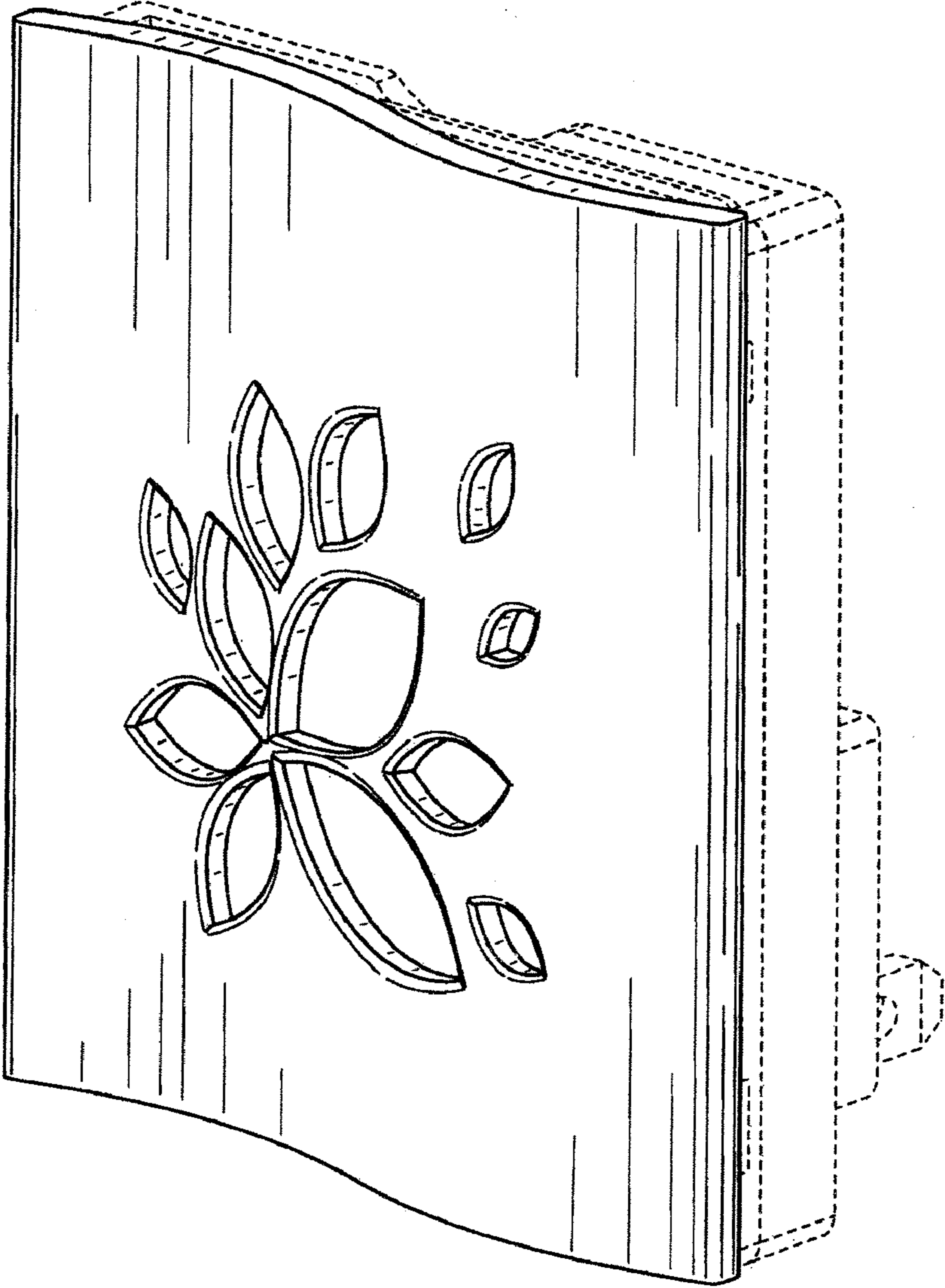

FIG. 1

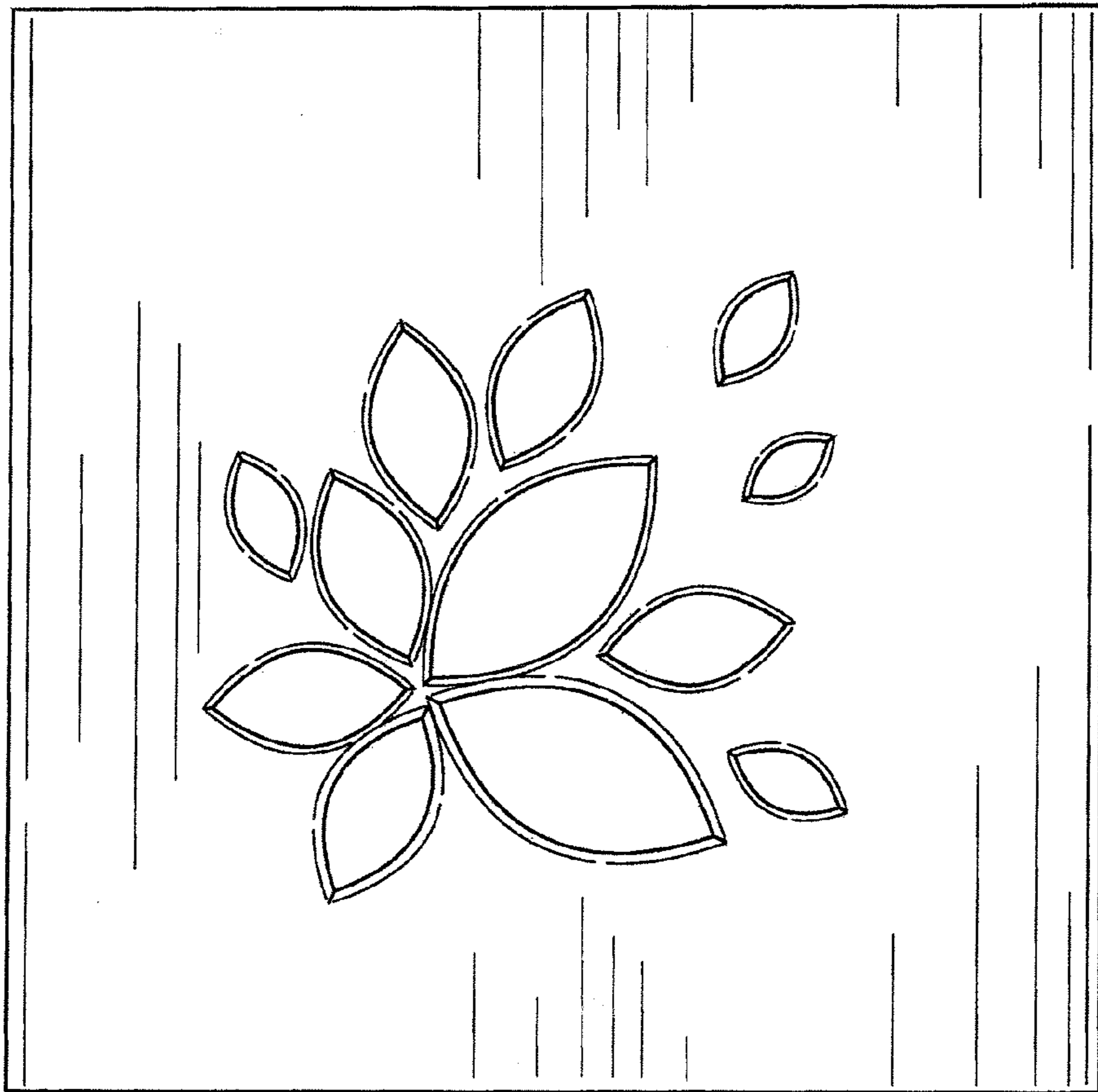

FIG. 2

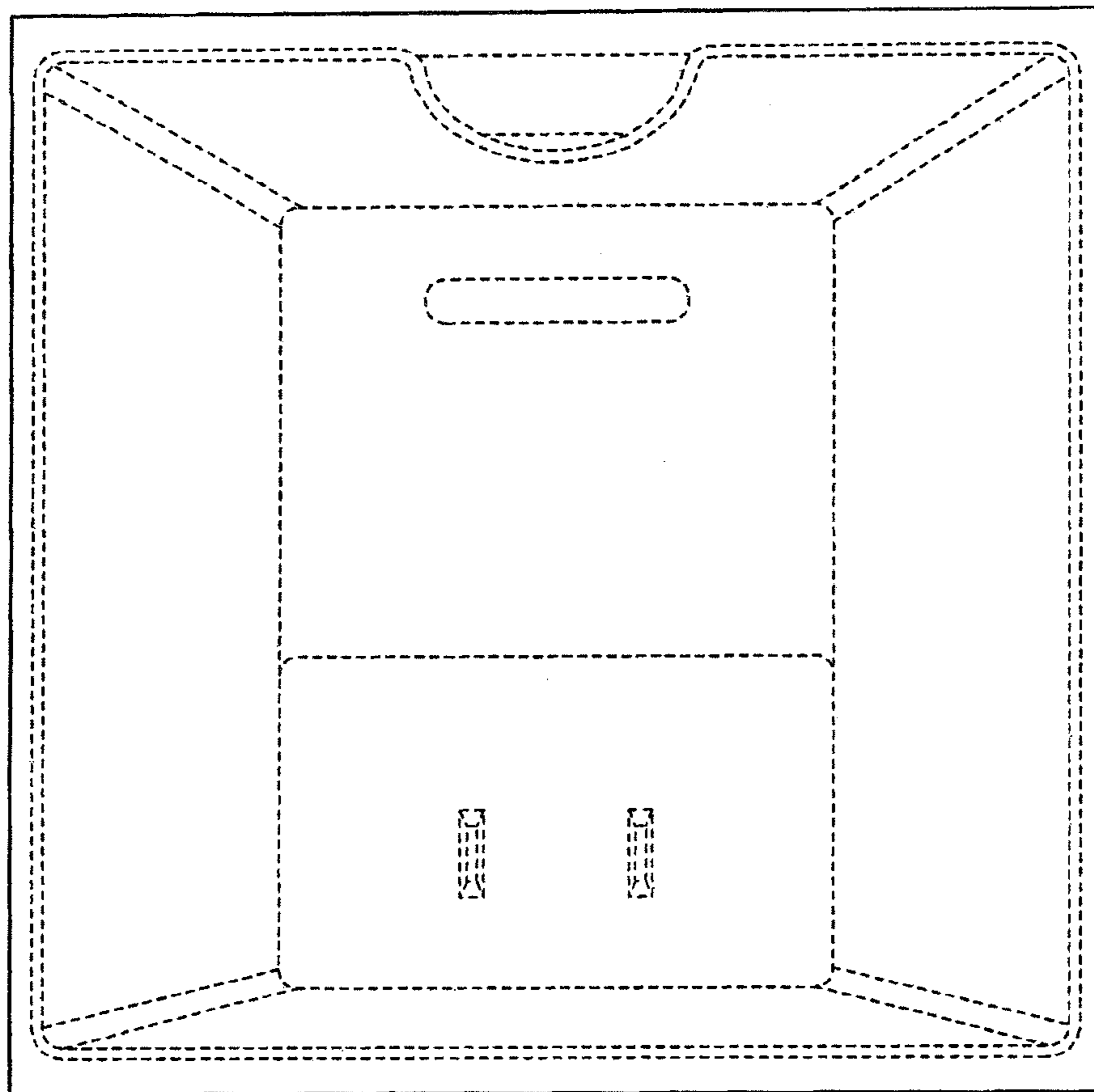

FIG. 3

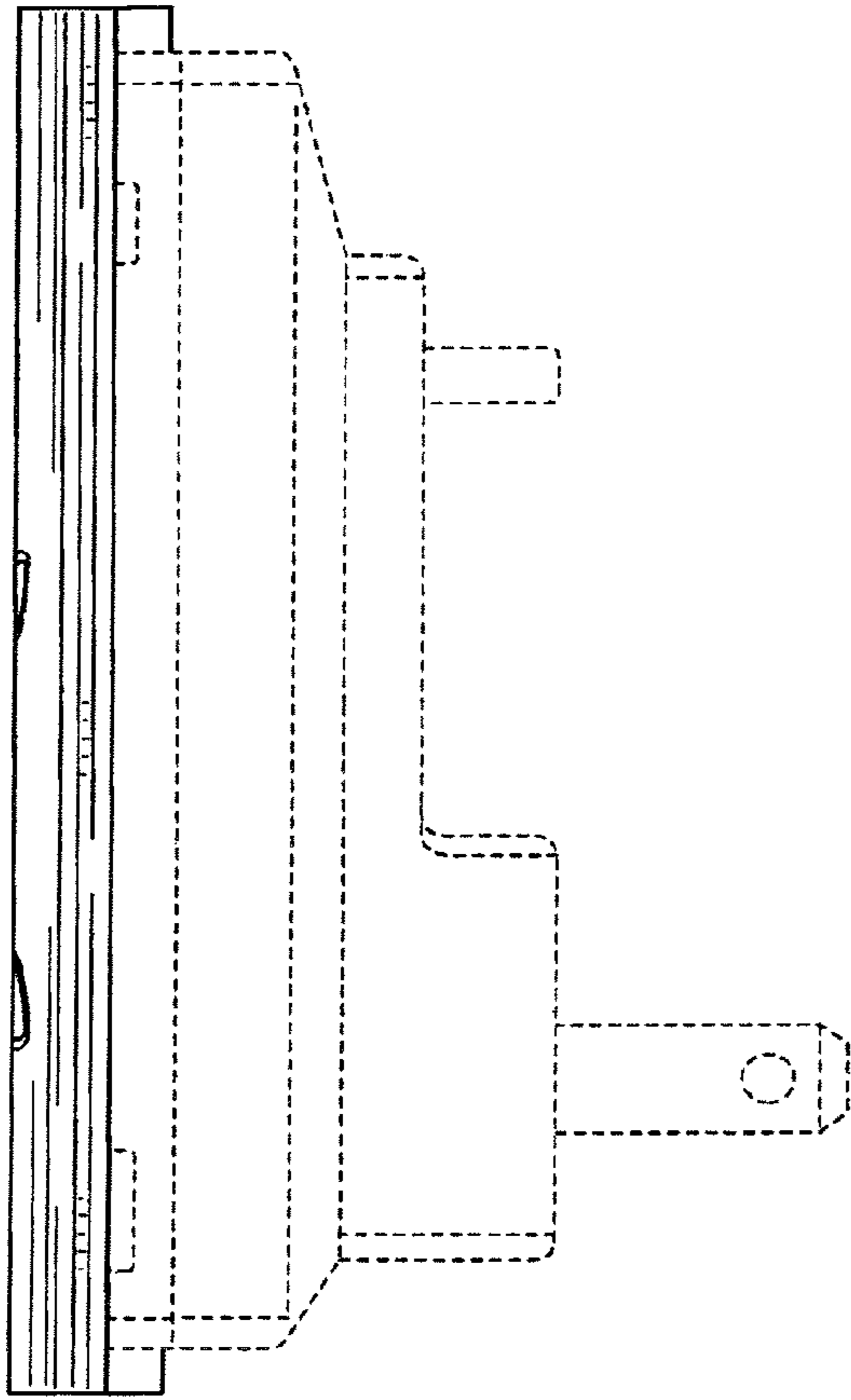

FIG. 4

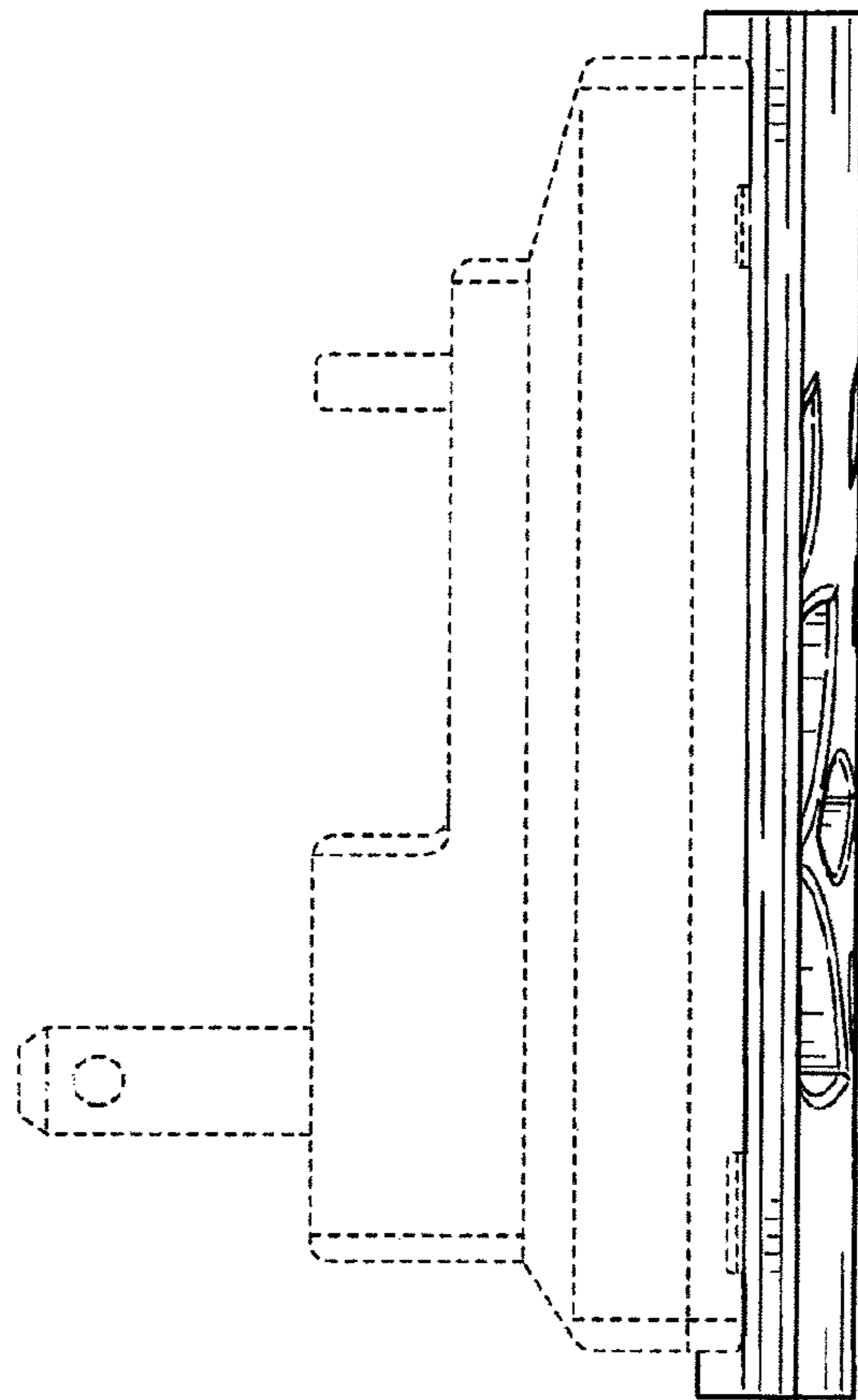

FIG. 5

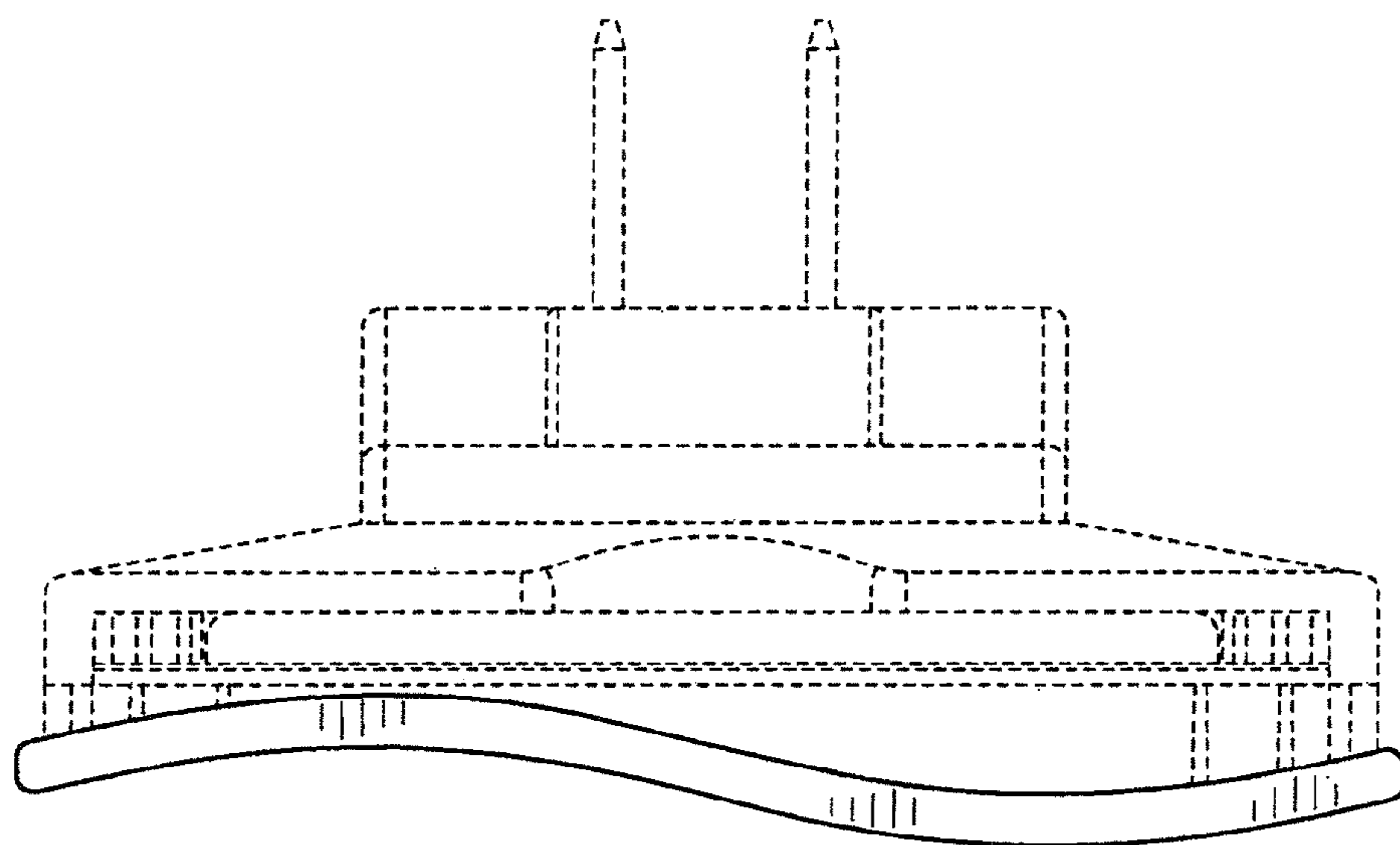

FIG. 6

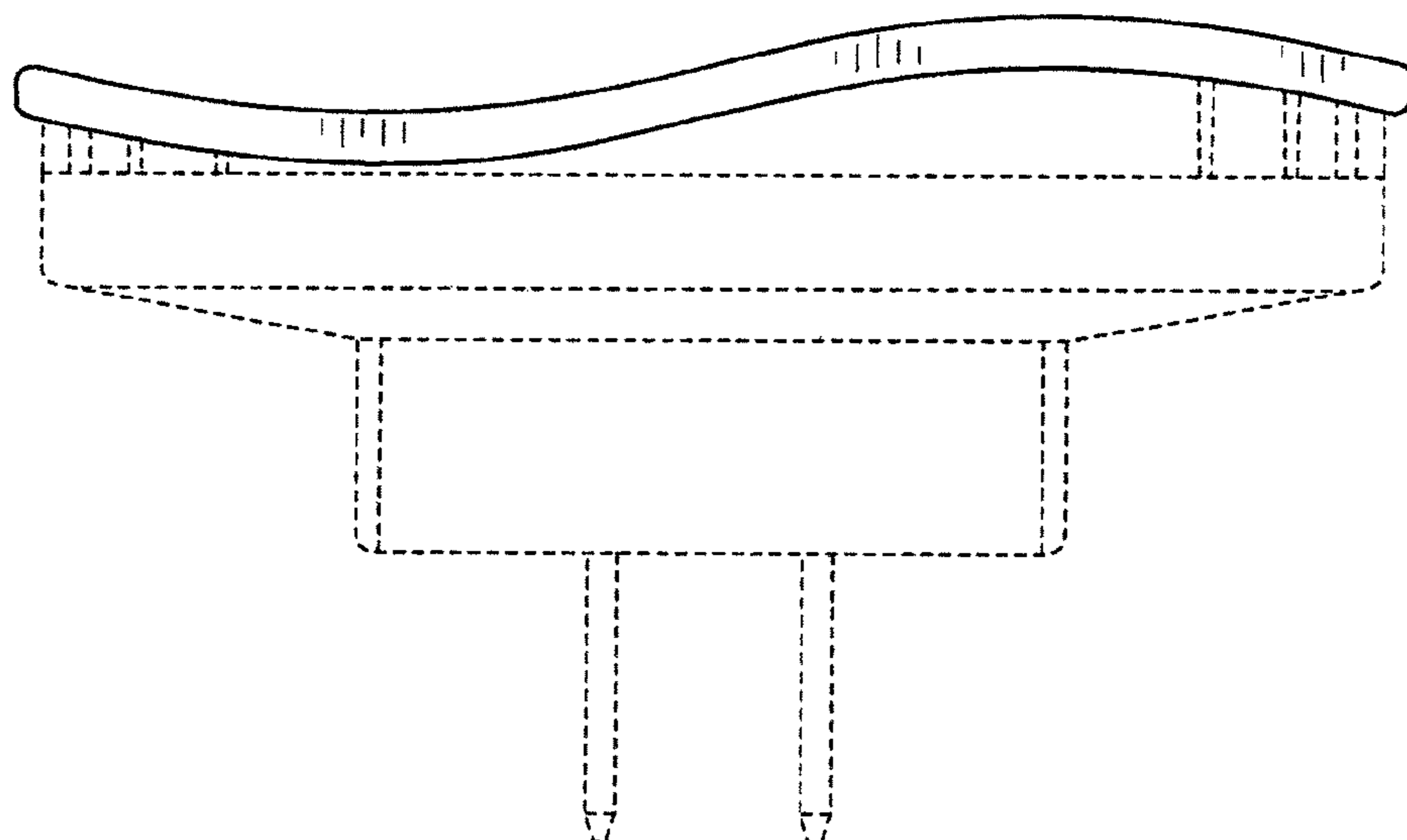

FIG. 7

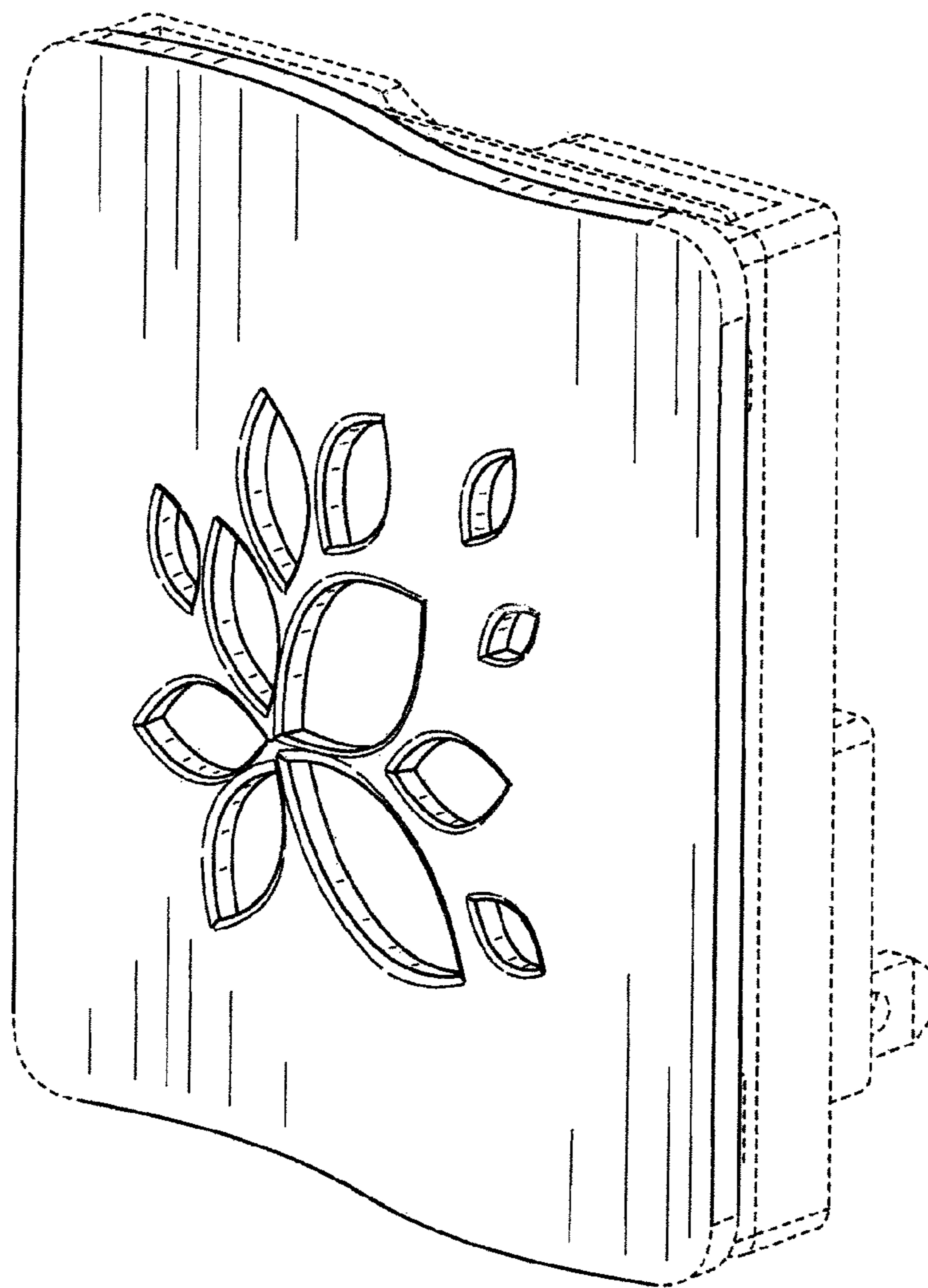

FIG. 8

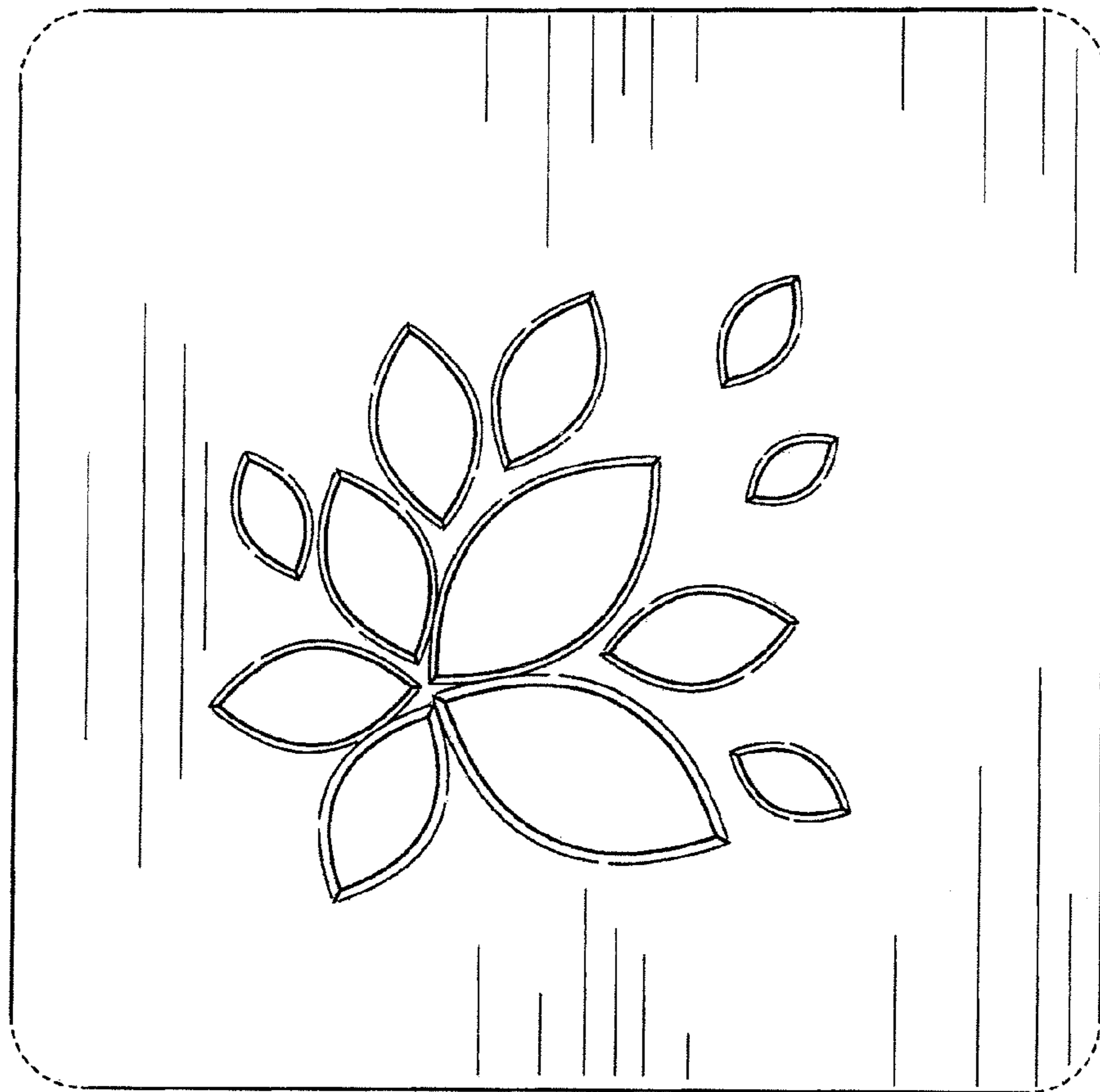

FIG. 9

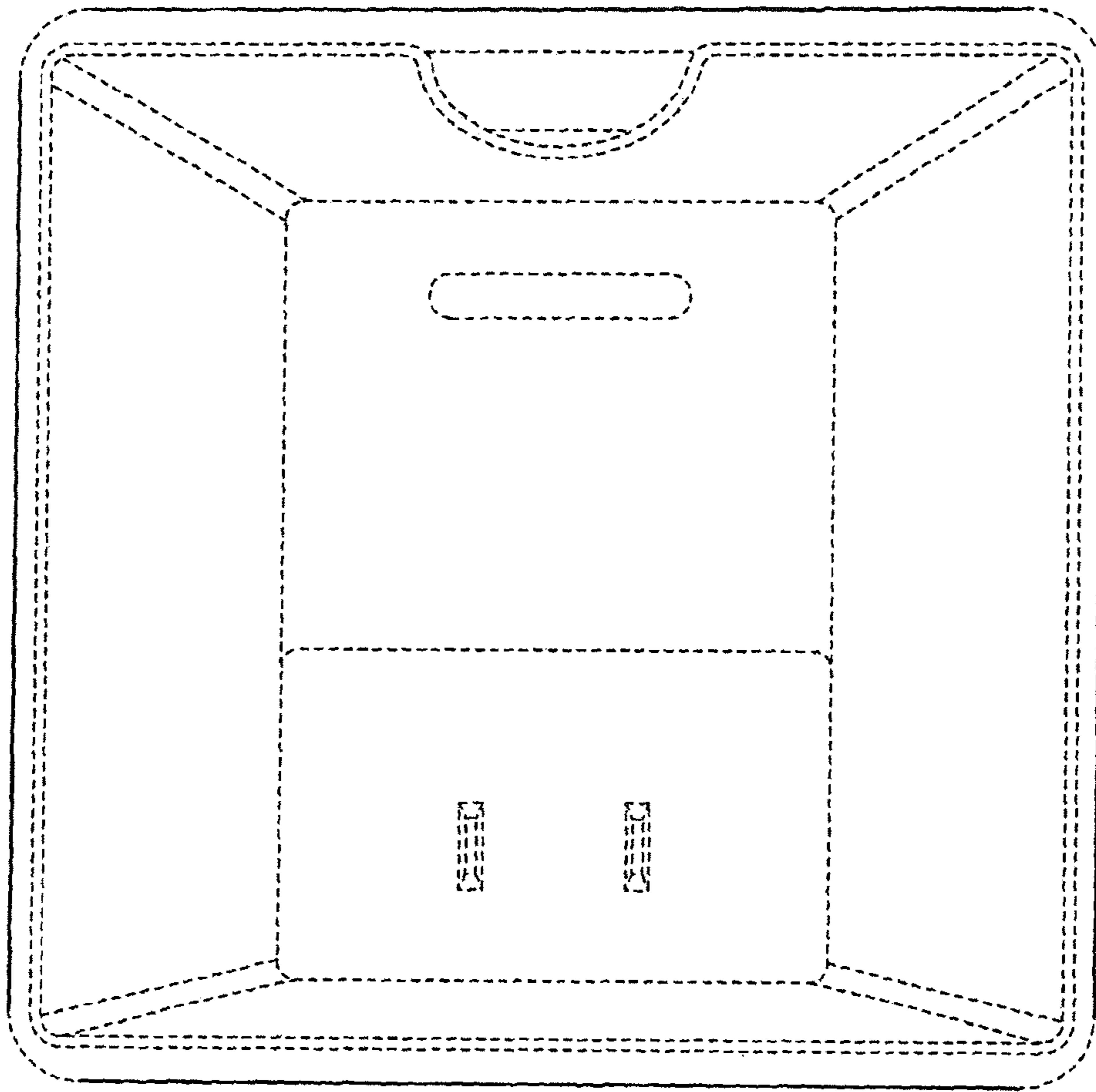

FIG. 10

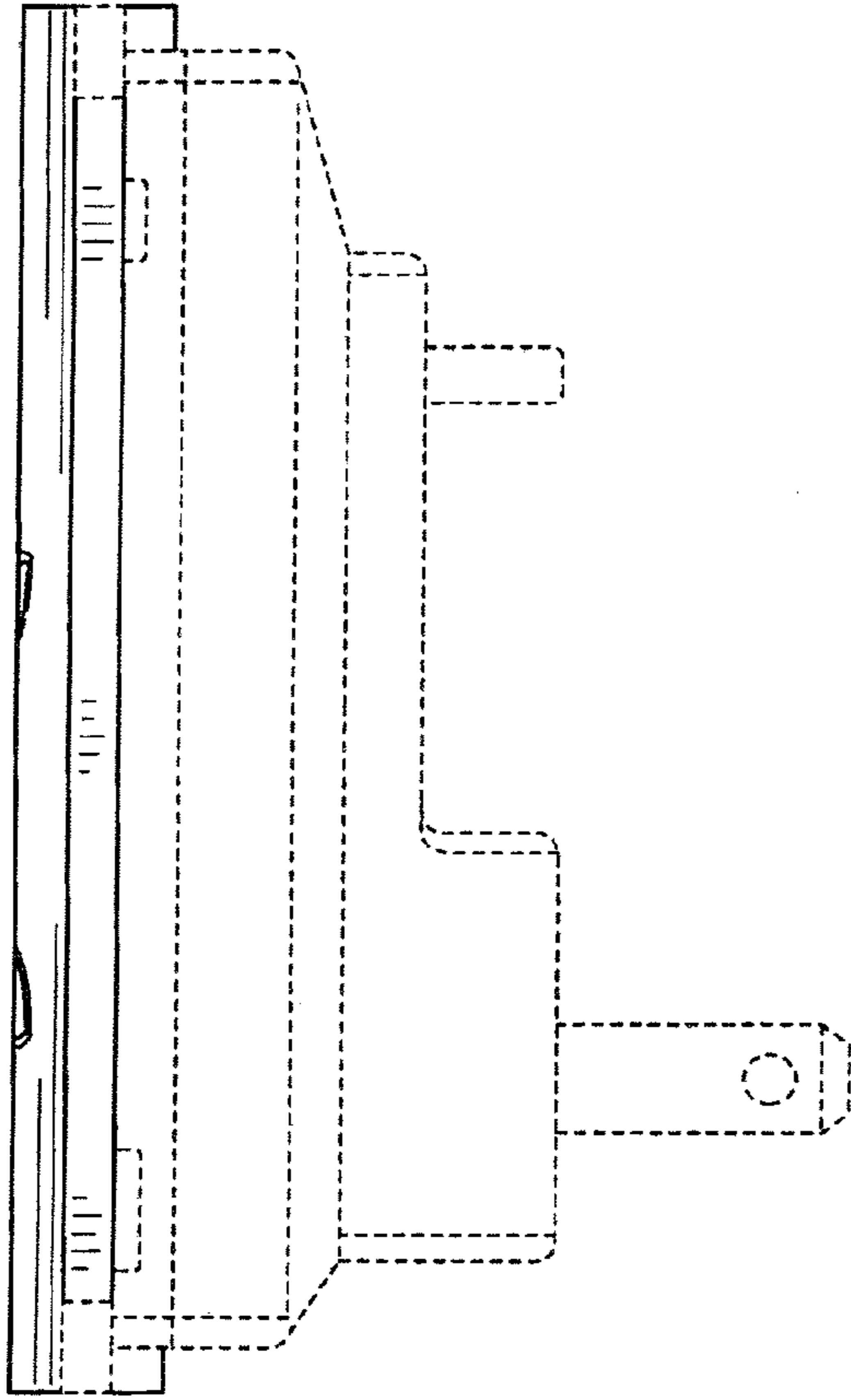

FIG. 11

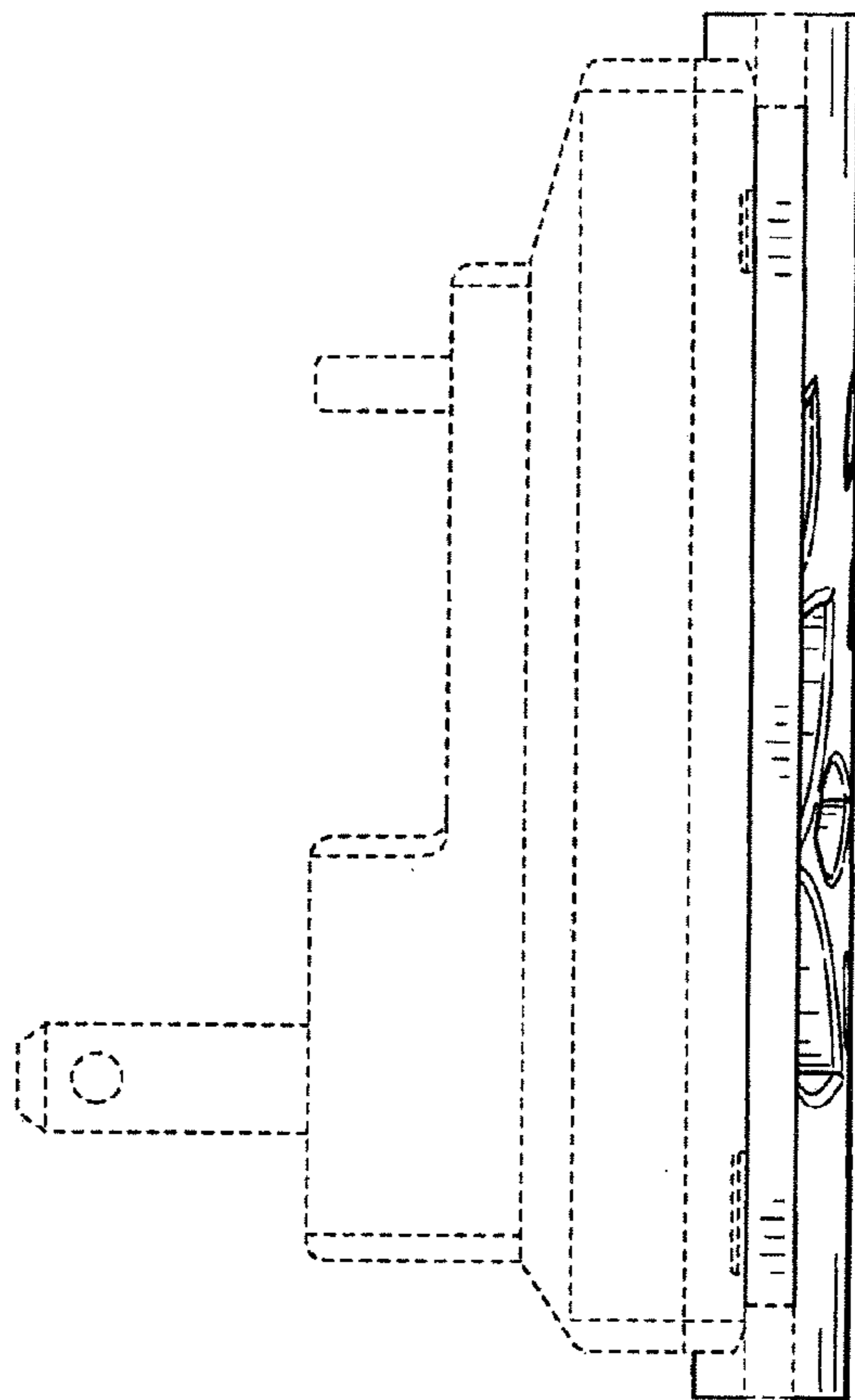

FIG. 12

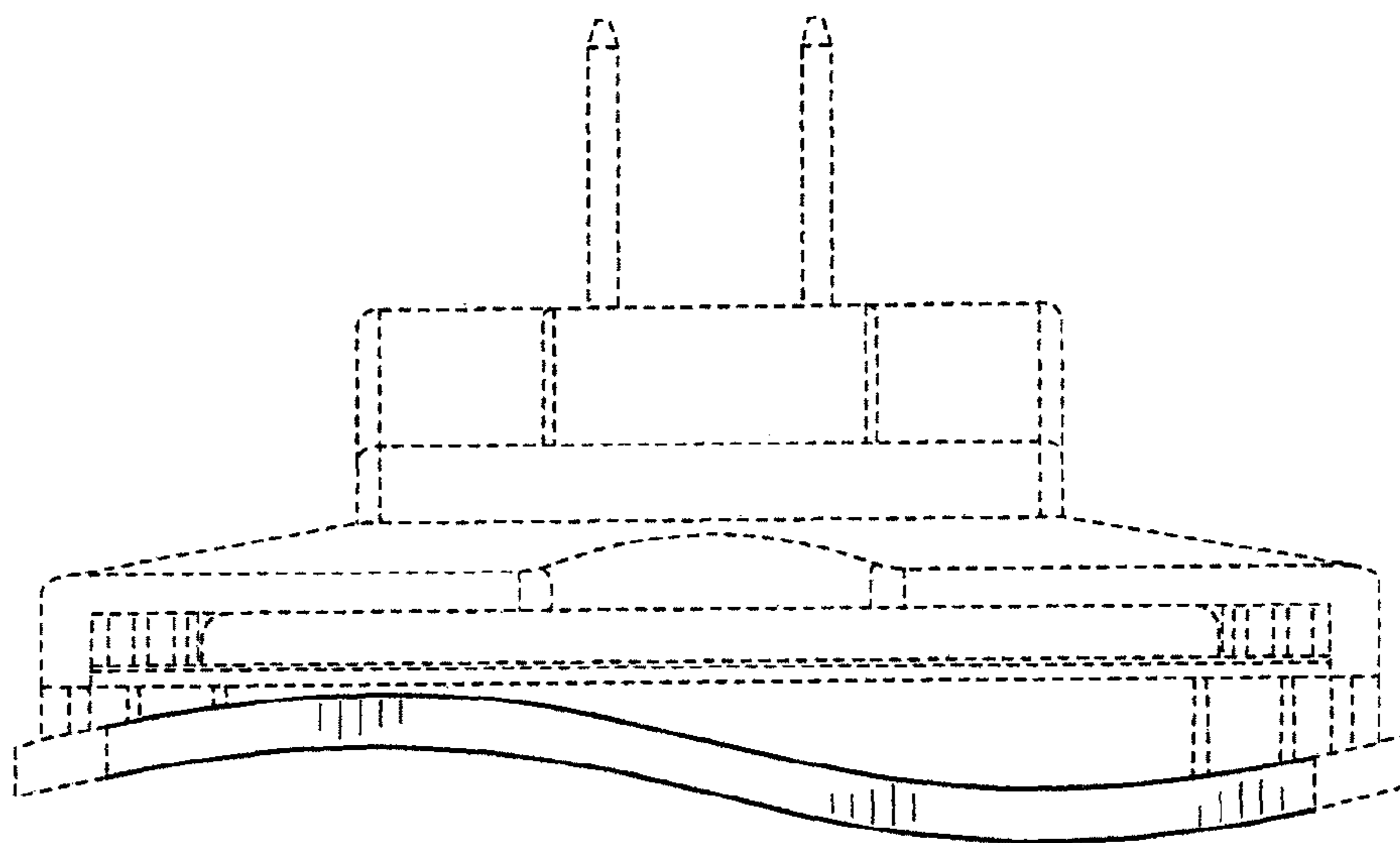

FIG. 13

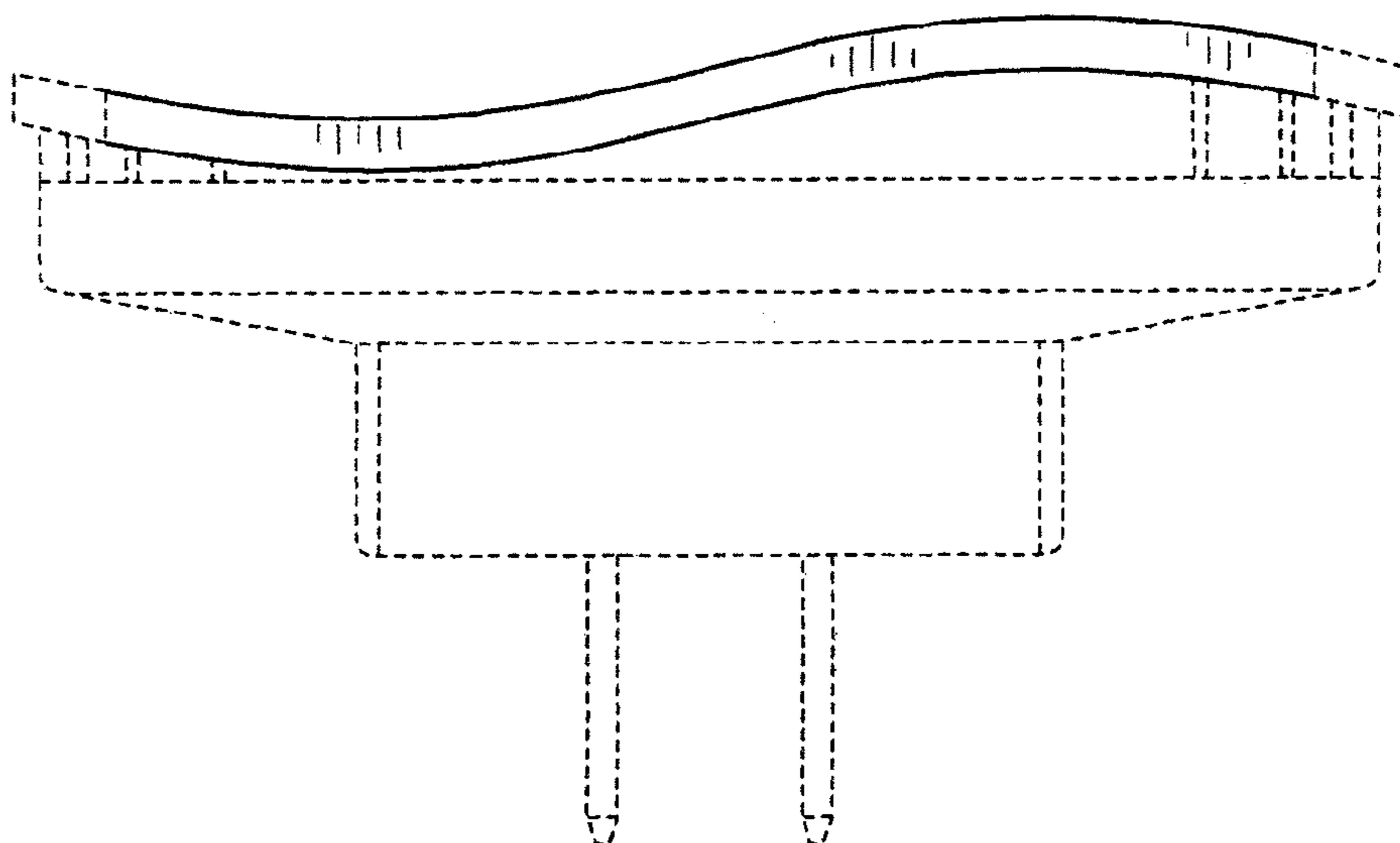

FIG. 14