



US00D674754S

(12) **United States Design Patent**
Zanoni et al.

(10) **Patent No.:** **US D674,754 S**
(45) **Date of Patent:** **** Jan. 22, 2013**

(54) **ELECTRIC RECEPTACLE**

(75) Inventors: **Gabor Zanoni**, Cambridge, MA (US);
Nicholas Rike Partridge, Brooklyn, NY
(US); **Jan Schminke**, Marshfield, MA
(US); **Phillip Donald Prestigomo**,
Simsbury, CT (US); **Theodore Peter**
Junko, Manlius, NY (US)

(73) Assignee: **The Wiremold Company**, West
Hartford, CT (US)

(**) Term: **14 Years**

(21) Appl. No.: **29/425,265**

(22) Filed: **Jun. 21, 2012**

Related U.S. Application Data

(62) Division of application No. 29/390,602, filed on Apr.
27, 2011.

(51) **LOC (9) Cl.** **13-03**

(52) **U.S. Cl.** **D13/139.1**

(58) **Field of Classification Search** D13/137.1,
D13/137.2, 137.3, 137.4, 138.1, 138.2, 139.1,
D13/139.2, 139.3, 139.4, 139.5, 139.6, 139.7,
D13/139.8, 101, 110, 123, 107, 108, 133,
D13/154, 184, 199; 439/131, 166, 628, 101,
439/102, 105, 106, 108, 172, 173, 174, 175,
439/177, 476.1, 578, 583, 620.15, 620.17;
363/15, 146, 34; 307/151; 320/111, 114;
174/493, 494, 66, 67

See application file for complete search history.

(56) **References Cited**

U.S. PATENT DOCUMENTS

2,673,969	A *	3/1954	Pfister	439/653
D216,262	S *	12/1969	Robinson	D13/137.2
D399,488	S *	10/1998	Williams	D13/139.7
6,118,643	A *	9/2000	Dyer et al.	361/111
D462,661	S *	9/2002	Owens	D13/139.6
D467,873	S *	12/2002	Yu	D13/137.2
D547,272	S *	7/2007	Ng	D13/137.2
7,371,122	B2 *	5/2008	Ivanova et al.	439/652
D639,742	S *	6/2011	Doucet	D13/139.8
2012/0108085	A1 *	5/2012	Row	439/131

* cited by examiner

Primary Examiner — Angela J Lee

(74) *Attorney, Agent, or Firm* — McCormick, Paulding &
Huber LLP

(57) **CLAIM**

The ornamental design for electric receptacle, as shown and
described.

DESCRIPTION

FIG. 1 is a front, top, left-hand side perspective view of an
electric receptacle comprising a new, original and ornamental
design;

FIG. 2 is a front view of an electric receptacle comprising the
new, original and ornamental design;

FIG. 3 is a rear view of an electric receptacle comprising the
new, original and ornamental design;

FIG. 4 is a right-hand side view of an electric receptacle
comprising the new, original and ornamental design;

FIG. 5 is a left-hand side view of an electric receptacle com-
prising the new, original and ornamental design; and,

FIG. 6 is a top view of an electric receptacle comprising the
new, original and ornamental design.

No claim is being made to the bottom view of the embodi-
ments, therefore, none has been shown.

1 Claim, 4 Drawing Sheets

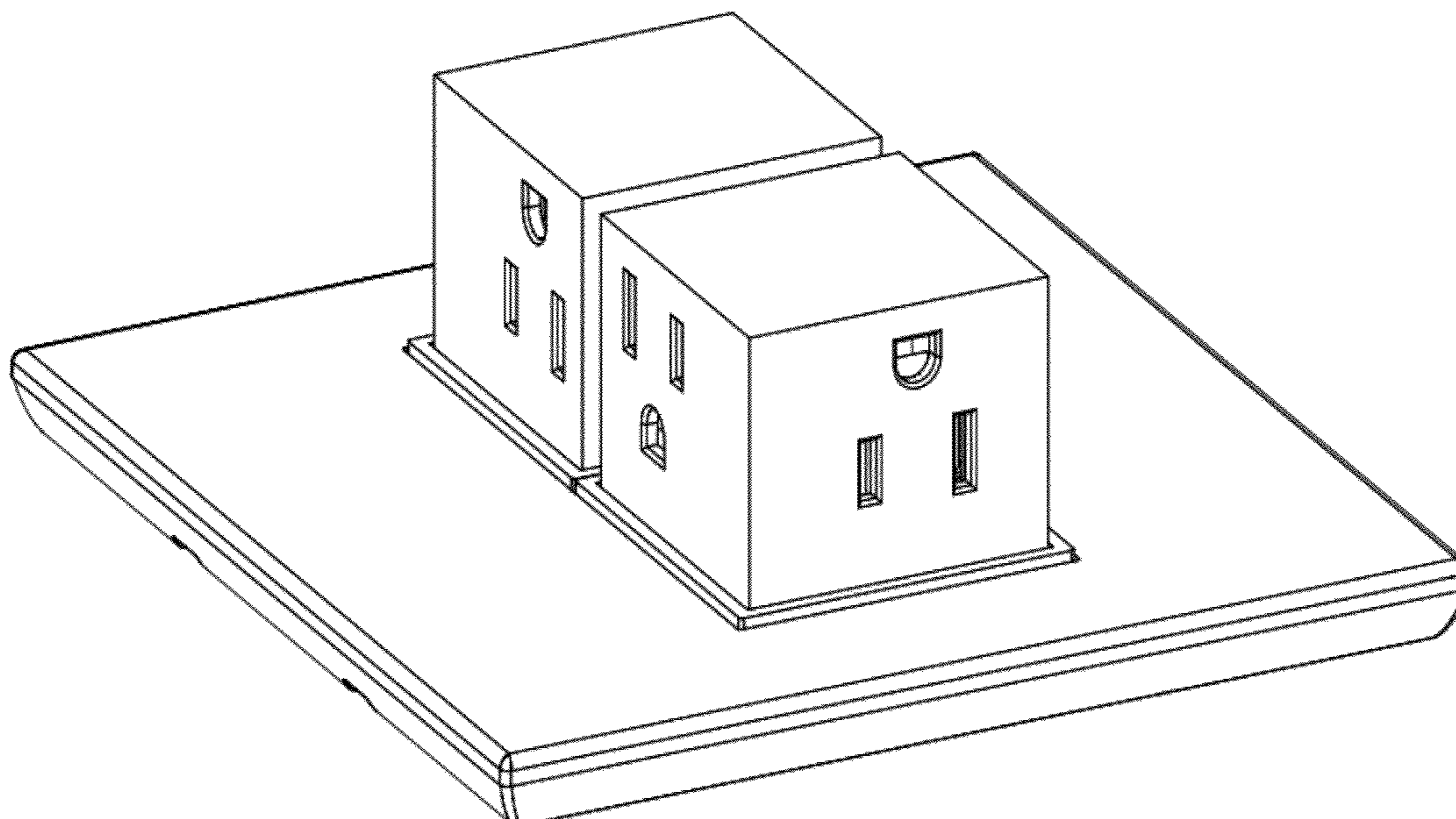

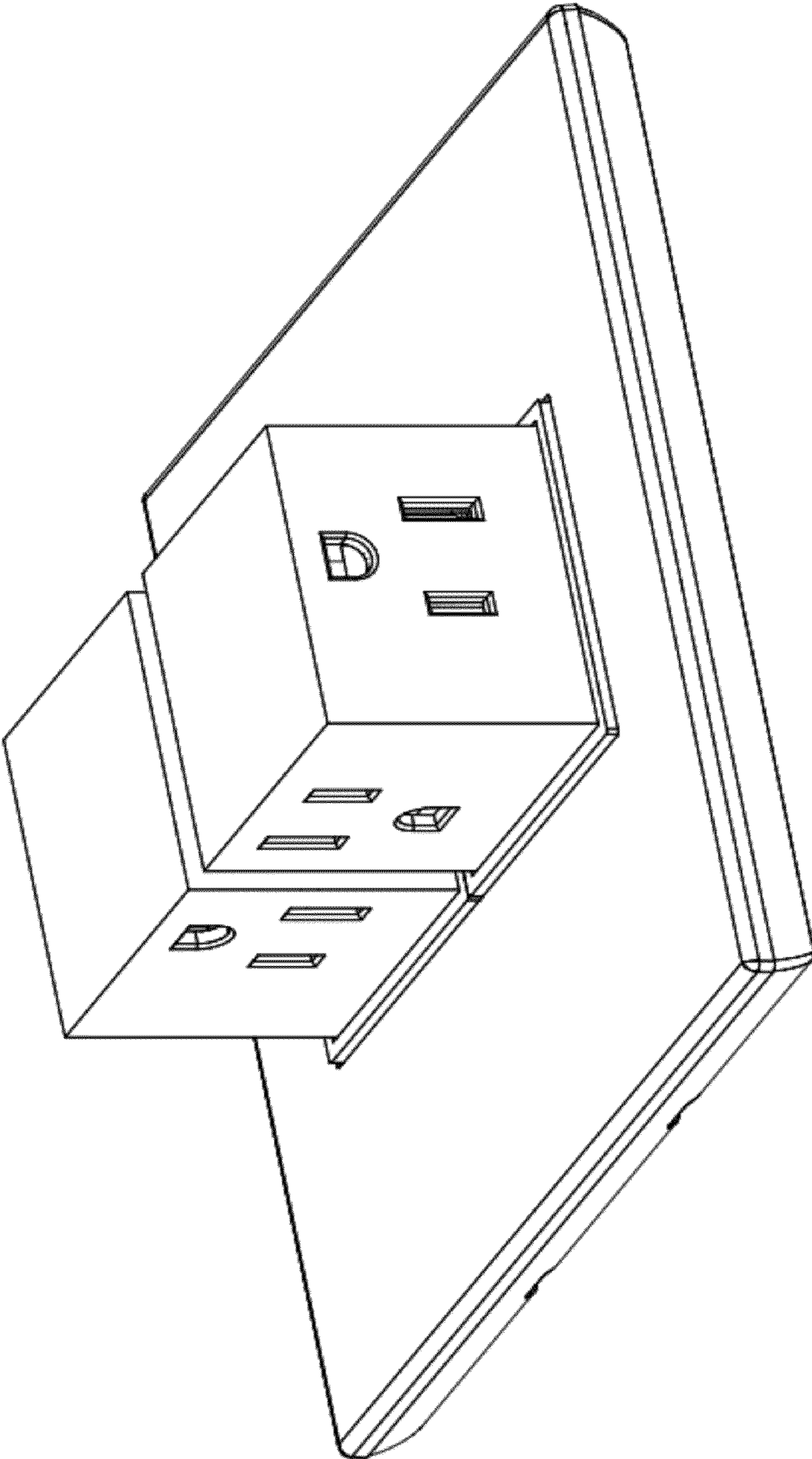

FIG. 1

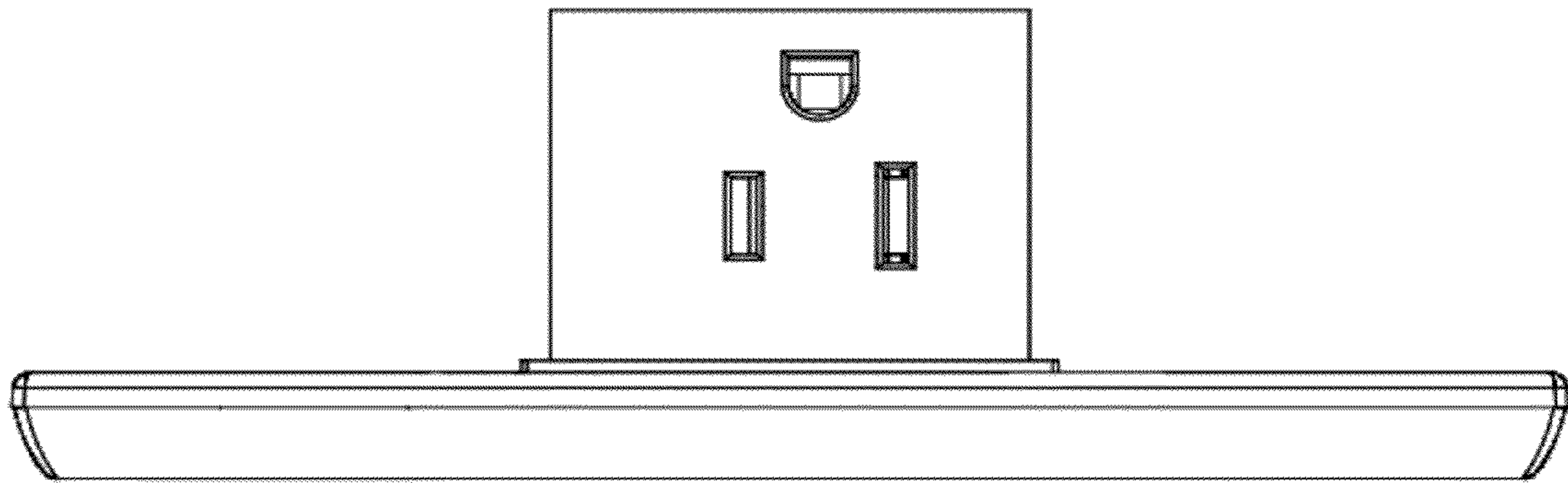

FIG. 2

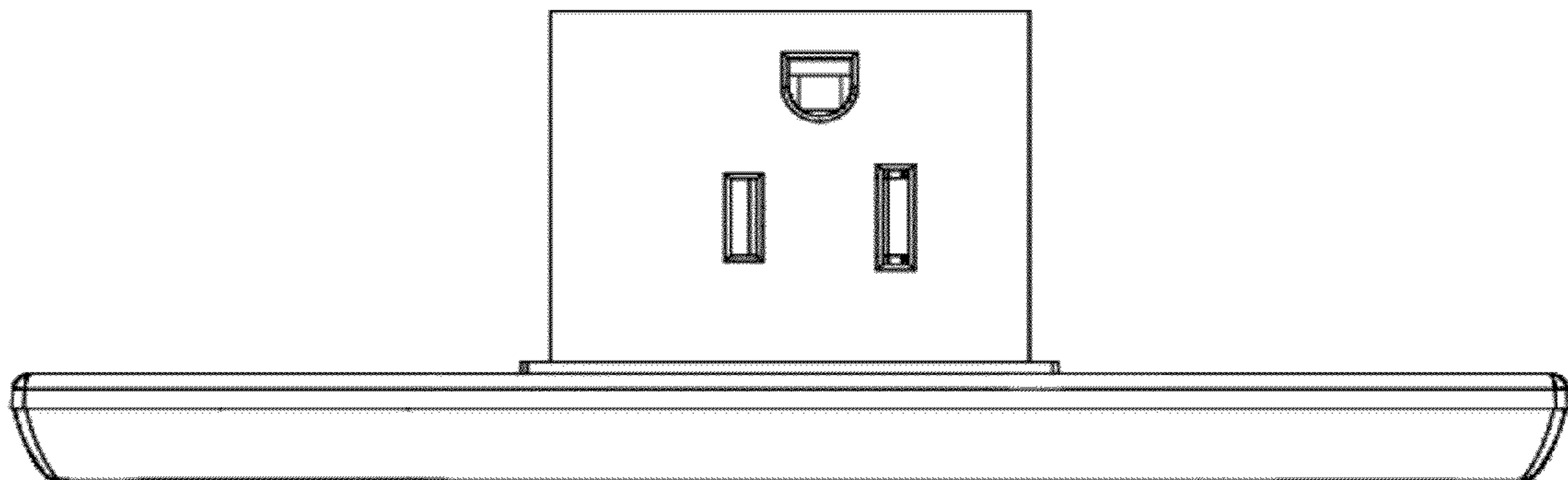

FIG. 3

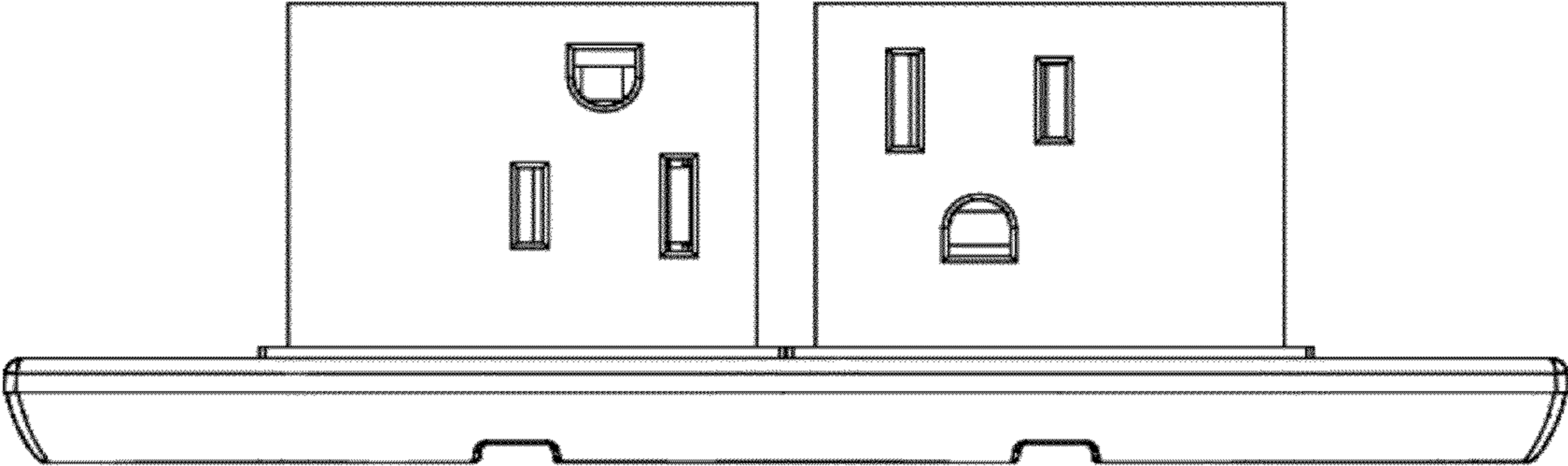

FIG. 4

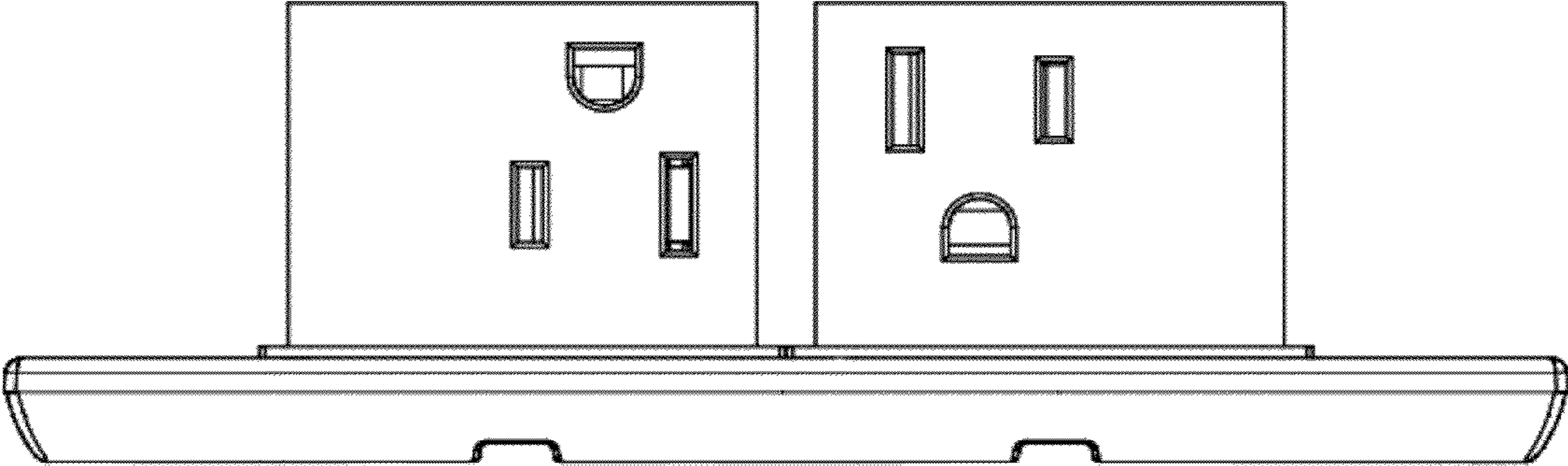

FIG. 5

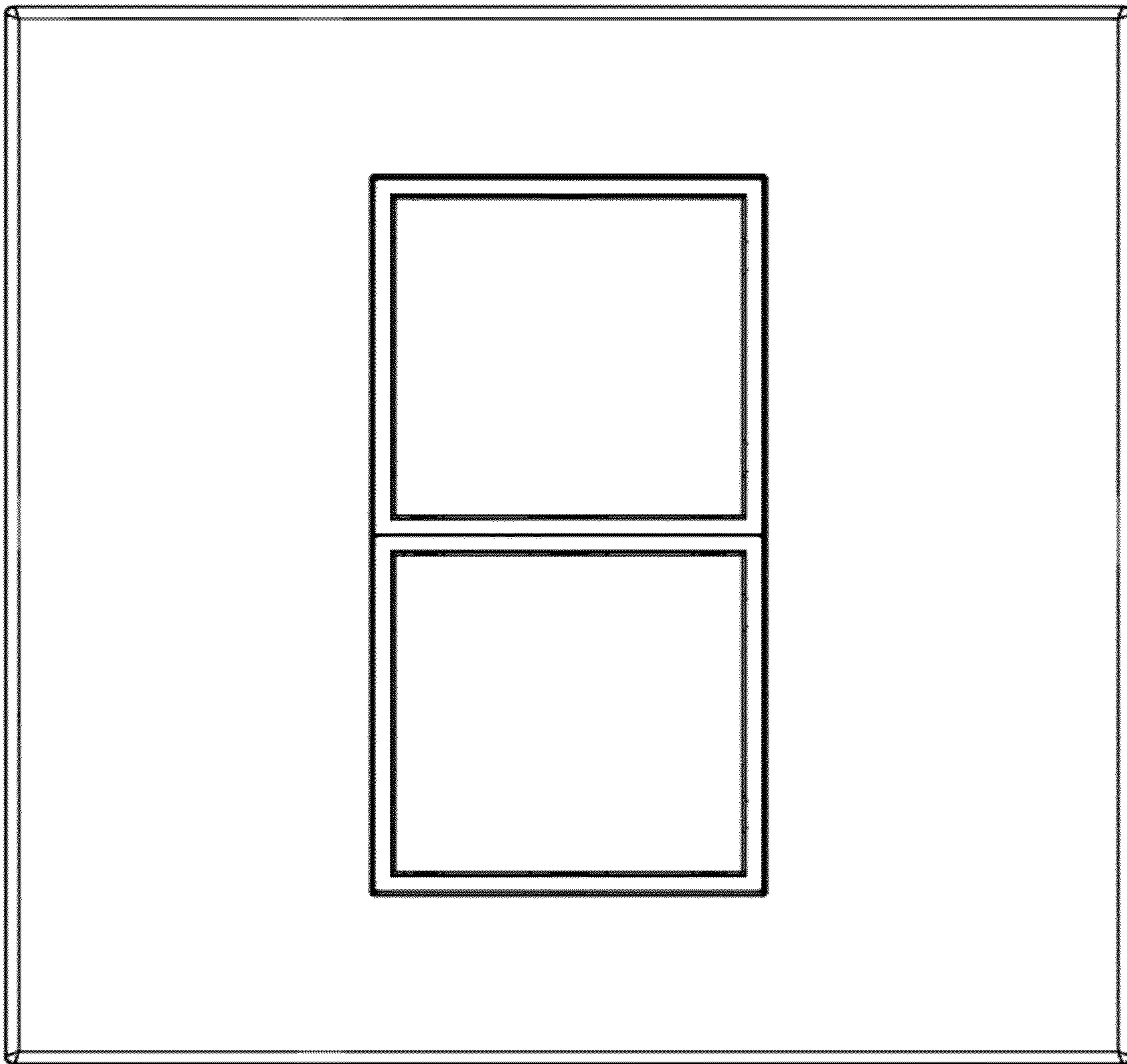

FIG. 6