



US00D674691S

(12) **United States Design Patent**  
**Martineck**

(10) **Patent No.:** **US D674,691 S**  
(45) **Date of Patent:** **\*\* Jan. 22, 2013**

(54) **WINE BOX**

[http://www.best-b2b.com/Products/738/761-1/wooden-wine-box\\_295760.html](http://www.best-b2b.com/Products/738/761-1/wooden-wine-box_295760.html) searched RMS Oct. 25, 2012.\*

(76) Inventor: **Christopher Martineck**, Grand Island, NY (US)

\* cited by examiner

(\*\*) Term: **14 Years**

*Primary Examiner* — Robert M Spear  
*Assistant Examiner* — Rhea Shields

(21) Appl. No.: **29/390,152**

(74) *Attorney, Agent, or Firm* — Vincent G. LoTempio; Kloss, Stenger & LoTempio

(22) Filed: **Apr. 20, 2011**

(51) **LOC (9) Cl.** ..... **09-03**

(52) **U.S. Cl.** ..... **D9/432**

(58) **Field of Classification Search** ..... D9/414, D9/416, 423, 428, 430-33, 444, 449, 455, D9/501-503, 508, 519, 522, 529, 531, 537, D9/545, 548-52, 554, 558, 560, 564, 574, D9/575, 688-692, 711, 737, 738, 740-742, D9/744, 751, 755-756, 760, 415; D24/216, D24/516; 222/131; 206/446; 312/111  
See application file for complete search history.

(57) **CLAIM**

The ornamental design for a wine box, as shown and described.

**DESCRIPTION**

FIG. 1 is a top, front perspective view of a wine box of my design;  
FIG. 2 is a top, side view of my design showing a stacked wine box array comprised of four wine box units of my design. The dashed subunits are to illustrate that wine box arrays may be comprised of any number of subunits placed in columns and/or rows;  
FIG. 3 is a front view of my design;  
FIG. 4 is a rear view of my design;  
FIG. 5 is a left side view of my design;  
FIG. 6 is a right side view of my design;  
FIG. 7 is a top view of my design; and,  
FIG. 8 is a bottom view of my design.  
The broken lines depict environmental structures of the wine box and form no part of the claim.

(56) **References Cited**

**U.S. PATENT DOCUMENTS**

3,567,298 A \* 3/1971 Ambaum et al. .... 312/111  
5,191,983 A 3/1993 Hardy  
D485,172 S \* 1/2004 Defino, Jr. .... D9/415

**OTHER PUBLICATIONS**

<http://www.havenboxes.com/default.asp?F=ShowProduct&ProductID=45> searched RMS Oct. 25, 2012.\*  
<http://www.woodthings.com/wholesale/w10.htm> searched RMS Oct. 25, 2012.\*  
<http://www.uncommongoods.com/product/anniversary-wine-box> searched RMS Oct. 25, 2012.\*

**1 Claim, 6 Drawing Sheets**

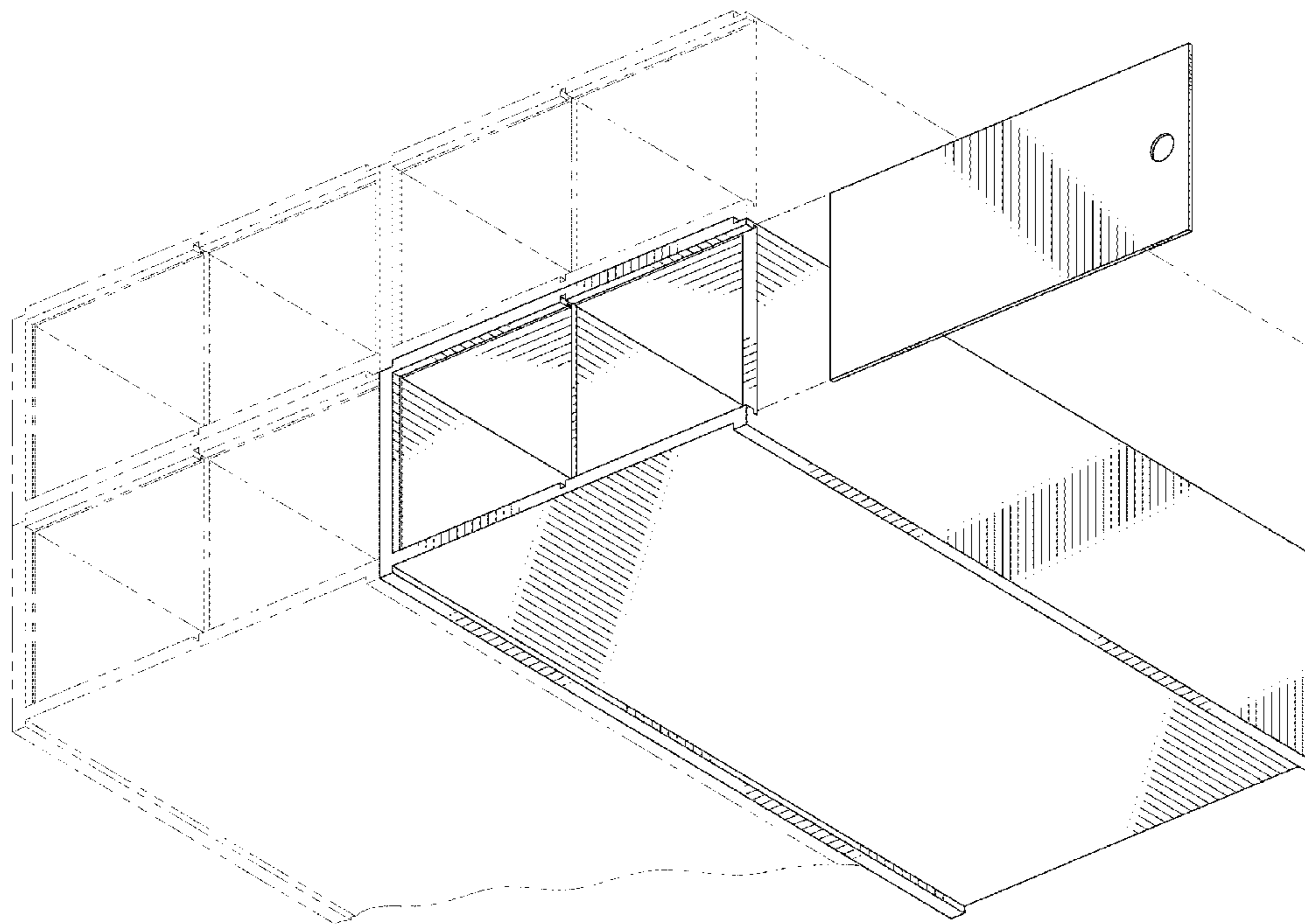

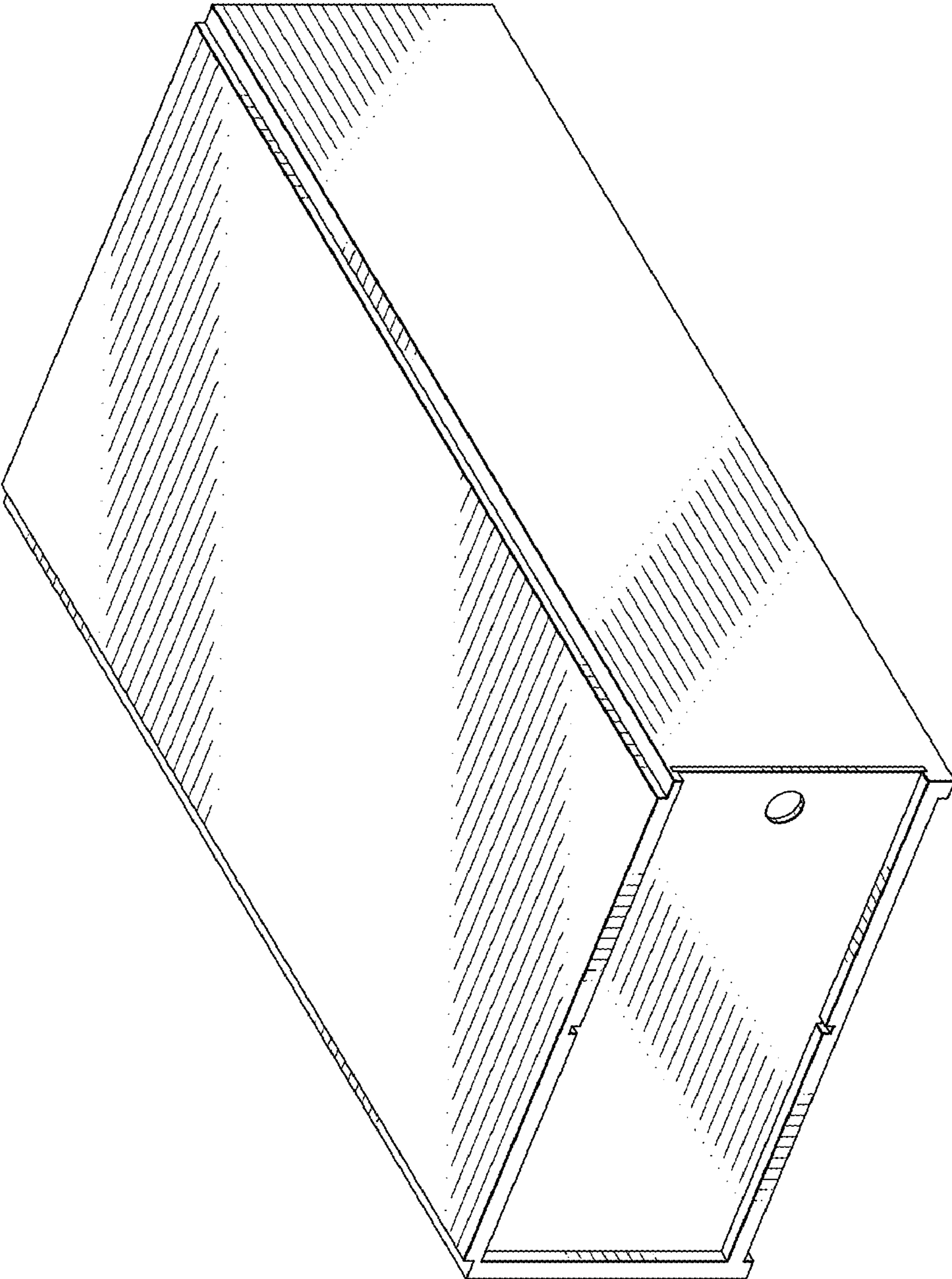

FIG.1

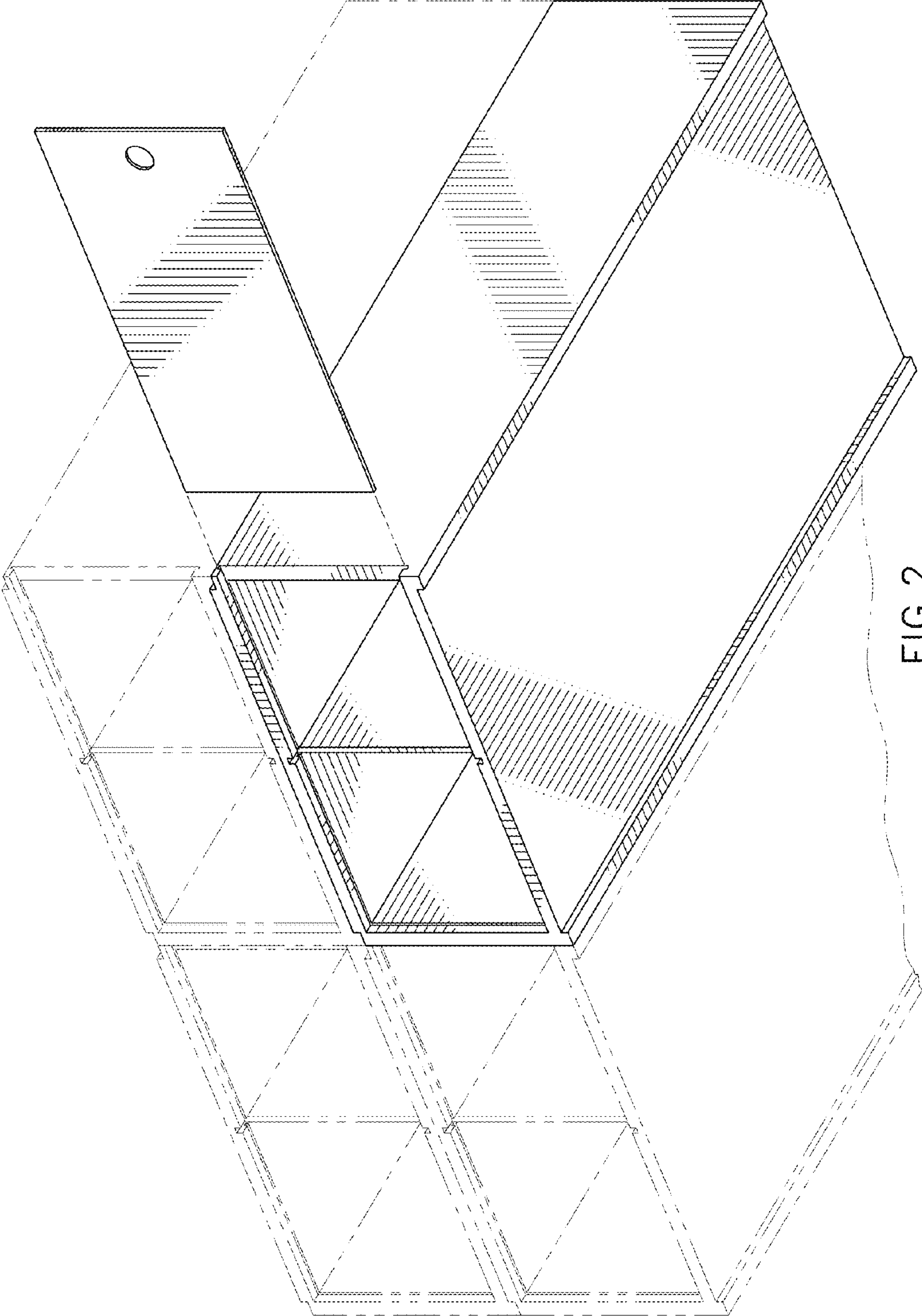

FIG. 2

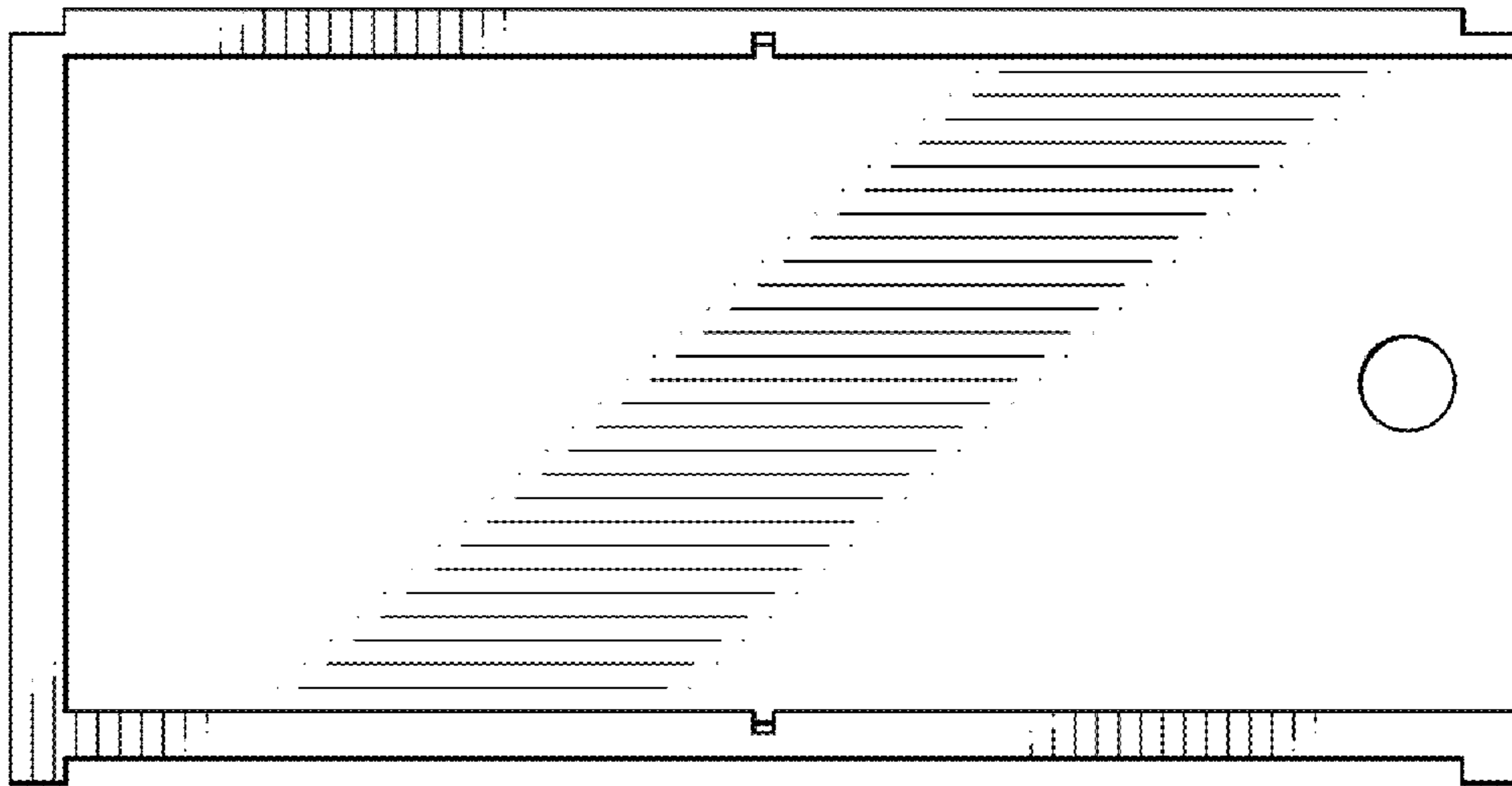

FIG. 3

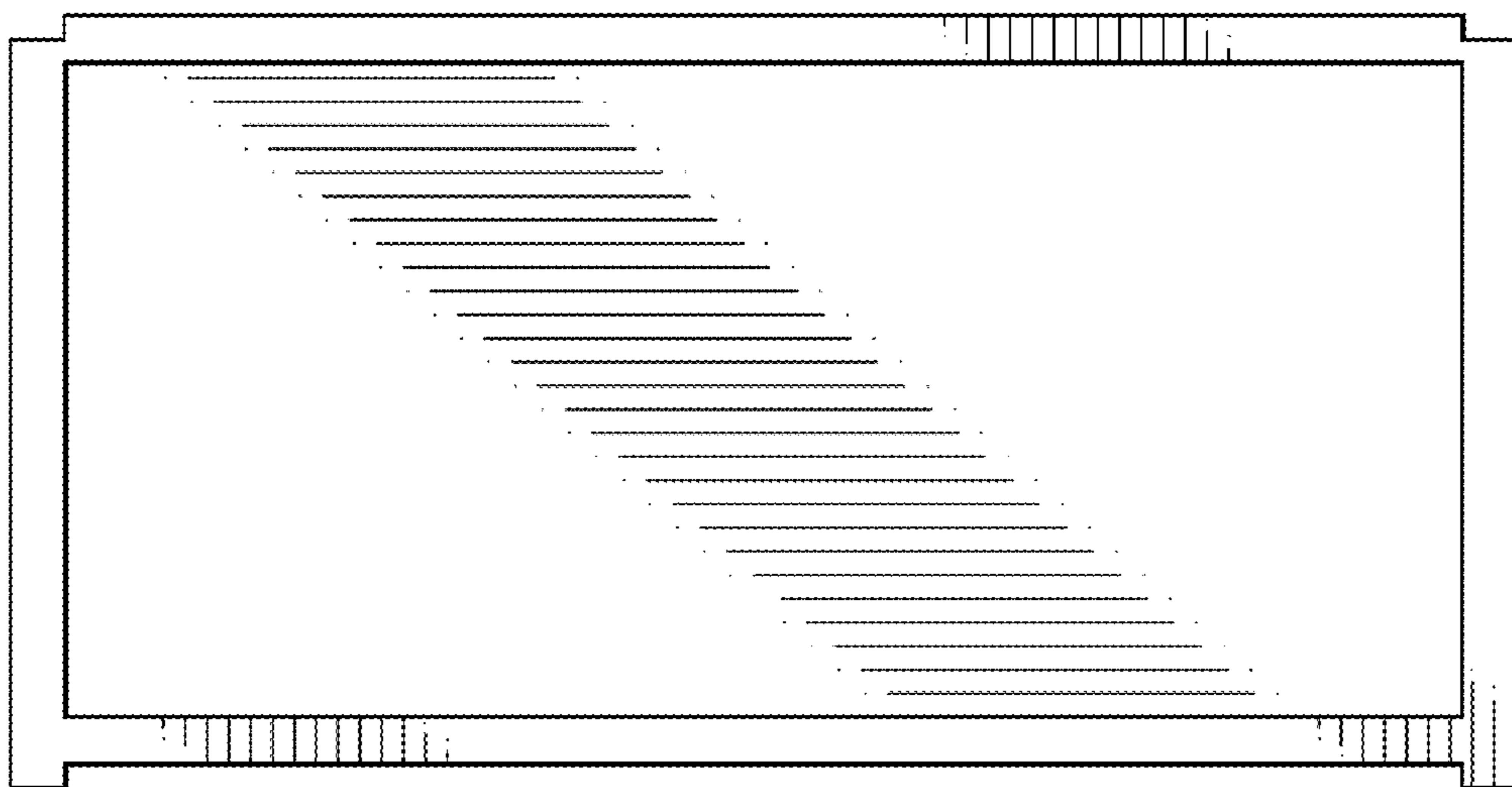

FIG. 4

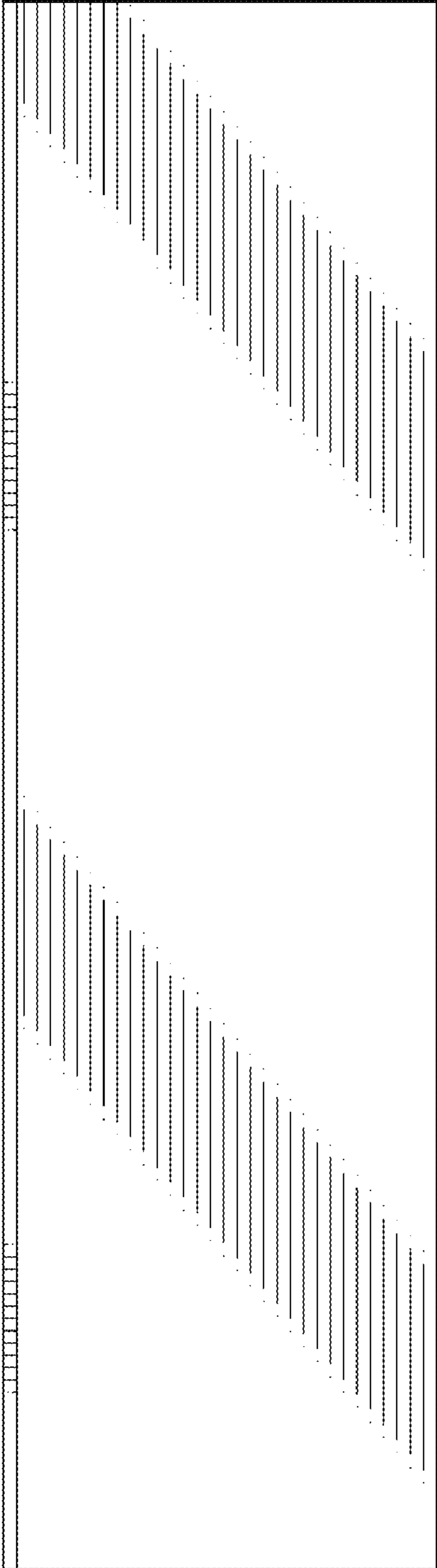

FIG. 5

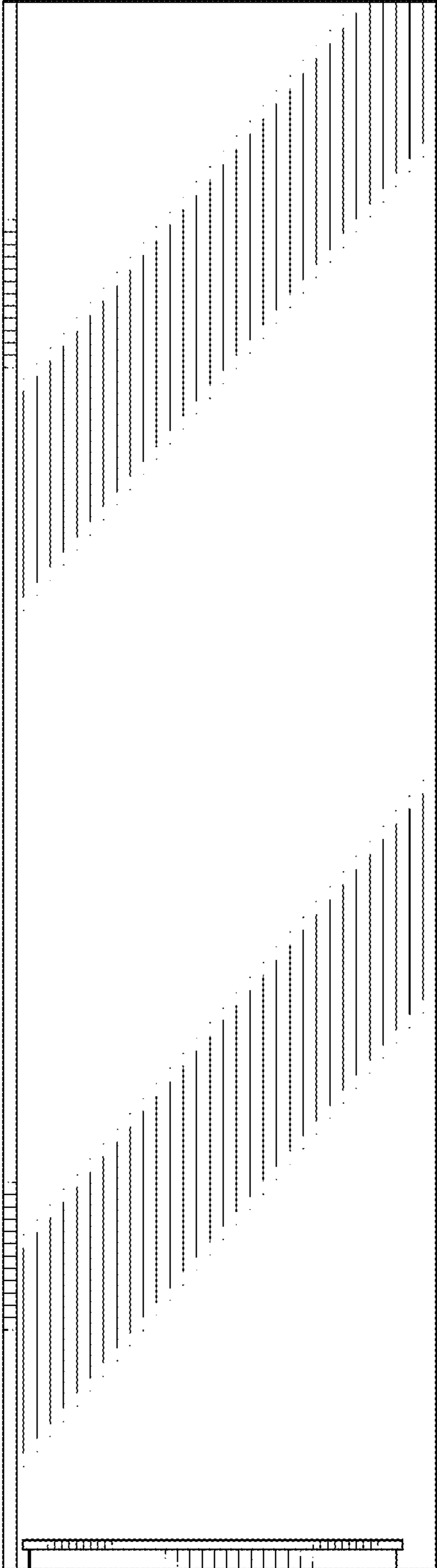

FIG. 6

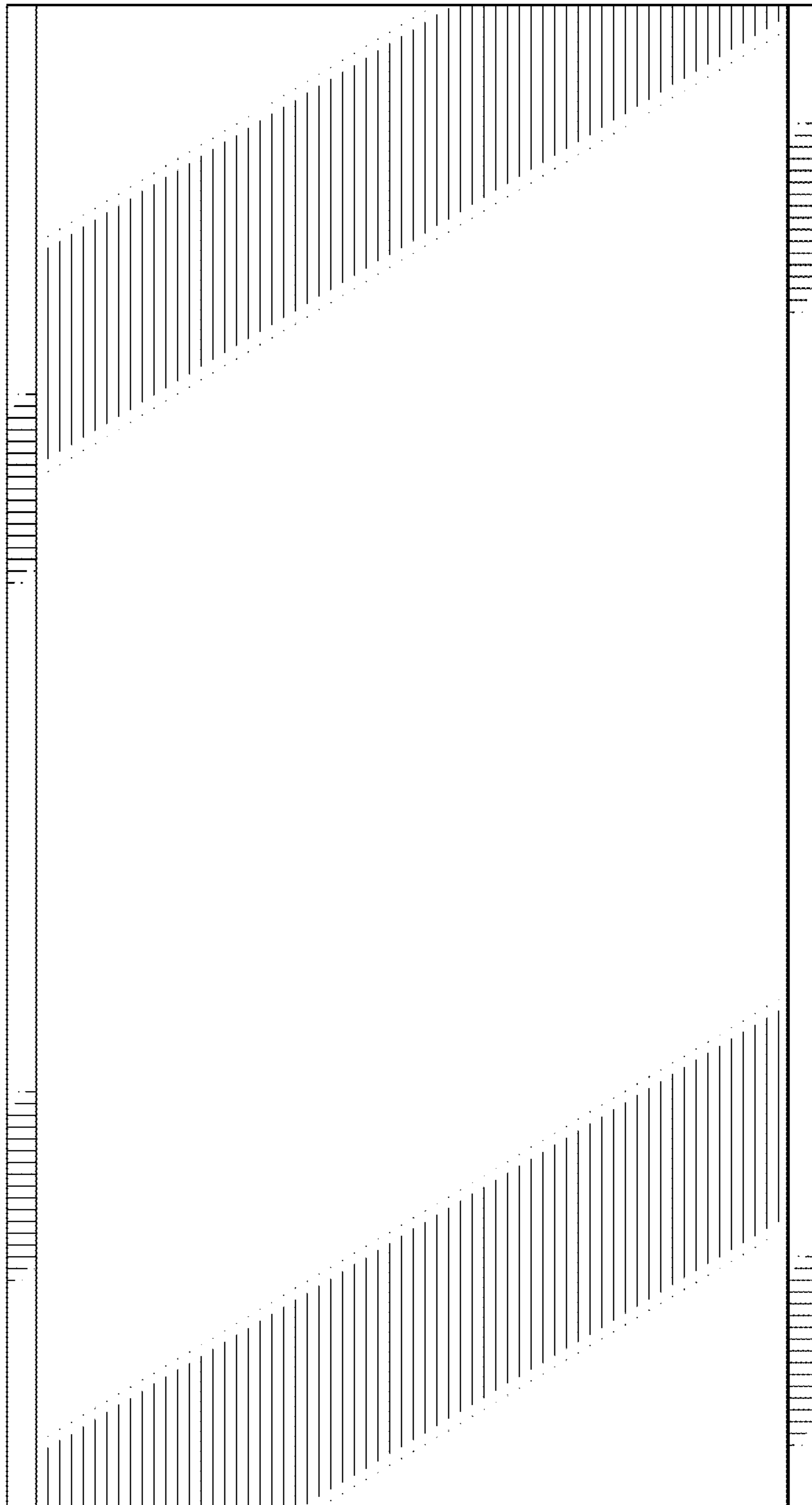

FIG.7

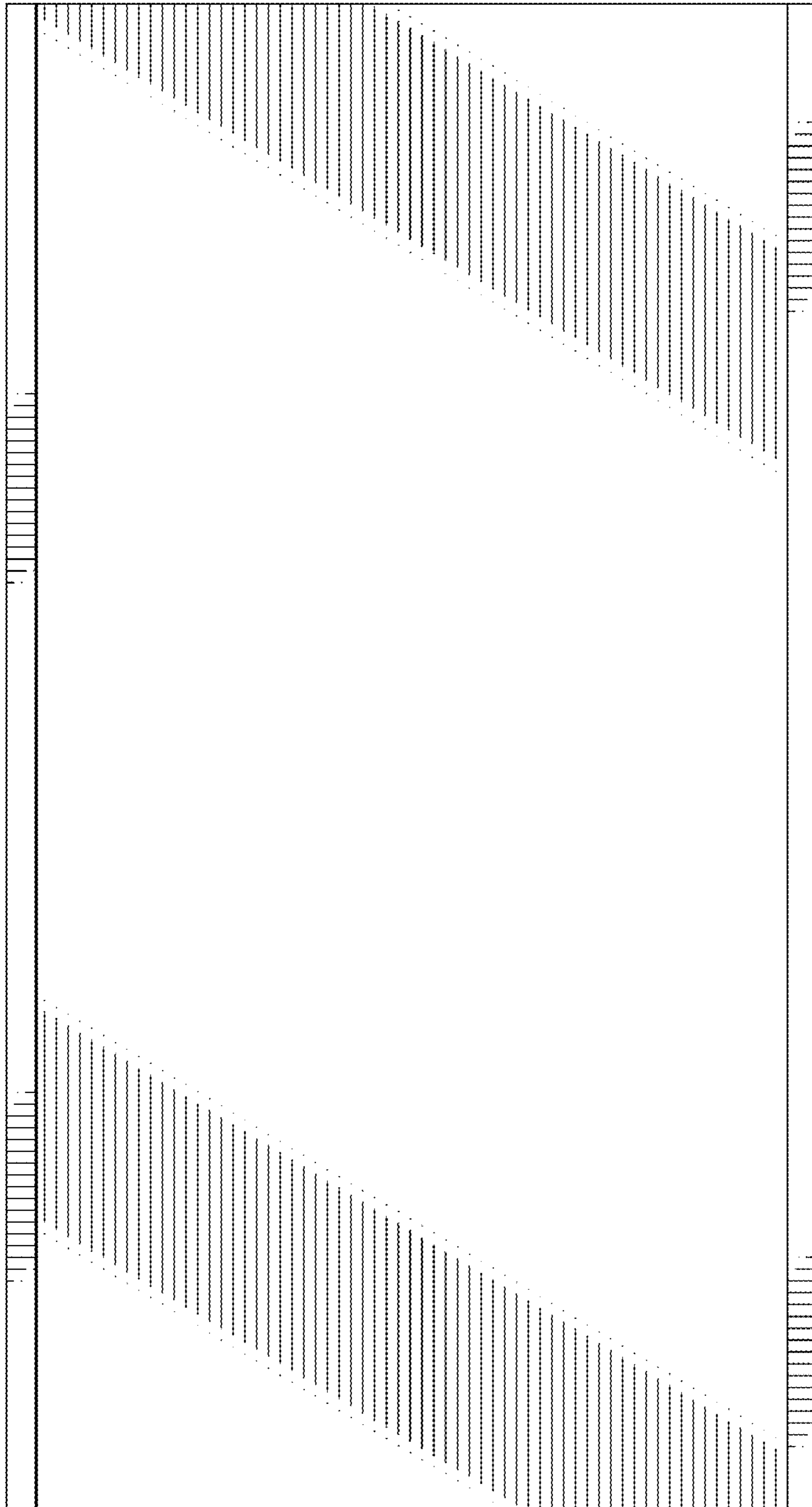

FIG.8