

US00D674678S

(12) **United States Design Patent**
Pickar et al.

(10) **Patent No.:** **US D674,678 S**
(45) **Date of Patent:** **** Jan. 22, 2013**

(54) **VEHICLE OUTSIDE DOOR HANDLE**

(75) Inventors: **Barbara J. Pickar**, New Hampton, IA (US); **Kevin P. Eschweiler**, New Hampton, IA (US); **Christopher R. Zenner**, Elma, IA (US); **Bruce E. Boerschel**, Charles City, IA (US)

(73) Assignee: **Trimark Corporation**, New Hampton, IA (US)

(**) Term: **14 Years**

(21) Appl. No.: **29/407,607**

(22) Filed: **Nov. 30, 2011**

(51) **LOC (9) Cl.** **08-06**

(52) **U.S. Cl.** **D8/302**

(58) **Field of Classification Search** D8/300,
D8/301, 302, 321, 331, 343, 352, 353; 70/208,
70/209, 218; 292/336.3, 337

See application file for complete search history.

(56) **References Cited**

U.S. PATENT DOCUMENTS

2,721,751	A *	10/1955	Holritz	292/169
D303,618	S *	9/1989	Russell et al.	D8/306
D304,155	S *	10/1989	Russell et al.	D8/303
4,989,907	A *	2/1991	Edmonds et al.	292/223
D339,050	S	9/1993	Gleason et al.		
D346,731	S *	5/1994	Larsen et al.	D8/301
D369,089	S *	4/1996	Zenner	D8/343
D373,298	S *	9/1996	Miehe et al.	D8/302
D383,664	S *	9/1997	Bennett	D8/331
D390,443	S *	2/1998	Zenner	D8/331
5,983,682	A *	11/1999	Parikh	70/208
D419,421	S	1/2000	Larsen et al.		
D459,969	S *	7/2002	Larsen et al.	D8/302
6,547,290	B1 *	4/2003	Zenner et al.	292/173
D485,155	S	1/2004	Bacon		
D496,576	S *	9/2004	Pickar et al.	D8/306
D498,655	S *	11/2004	Perfetti et al.	D8/306
D504,803	S *	5/2005	Misner et al.	D8/302

D519,823	S *	5/2006	Pickar et al.	D8/331
D529,367	S *	10/2006	Zweibohmer et al.	D8/301
D537,701	S *	3/2007	Houdek et al.	D8/302
7,232,162	B2 *	6/2007	Pickar	292/175
D614,016	S	4/2010	Zenner et al.		
D628,041	S *	11/2010	Tieu et al.	D8/302
D646,143	S *	10/2011	Stuckey	D8/321
D661,172	S *	6/2012	Pickar	D8/301

OTHER PUBLICATIONS

Bauer Products, bp-12, <http://www.bauerproducts.com/allproducts.php?ProductProduct=p1329&ProductCategory=>, 1 page, [retrieved from Internet on Nov. 25, 2011].

Bauer Products, bp-7 <http://www.bauerproducts.com/allproducts.php?ProductProduct=p5042788&ProductCategory=>, 1 page, [retrieved from Internet on Nov. 25, 2011].

Southco, R3 Push-to-Close Latch, pp. 166-168 Product Catalog Literature, 2011.

TriMark, 060-0600 Motor Home Entrance Door Hardware, brochure 30/11-4, 3 pages.

* cited by examiner

Primary Examiner — Paula Greene

(74) *Attorney, Agent, or Firm* — McKee, Voorhees & Sease, P.L.C.

(57) **CLAIM**

We claim the ornamental design for a vehicle outside door handle, substantially as shown and described.

DESCRIPTION

FIG. 1 is a perspective view of a vehicle outside door handle showing our new design;

FIG. 2 is an end view thereof;

FIG. 3 is an opposite end view thereof;

FIG. 4 is a side elevational view thereof;

FIG. 5 is an opposite side elevational view thereof; and,

FIG. 6 is a top plan view thereof.

The broken lines form no part of the claimed design.

1 Claim, 5 Drawing Sheets

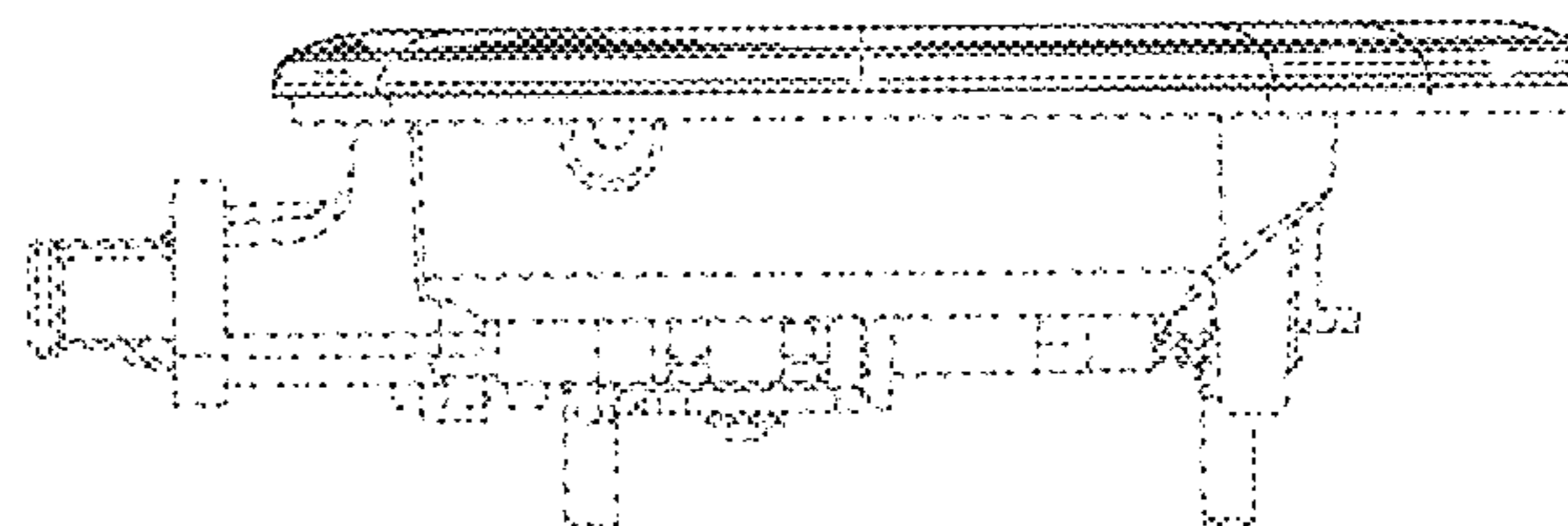
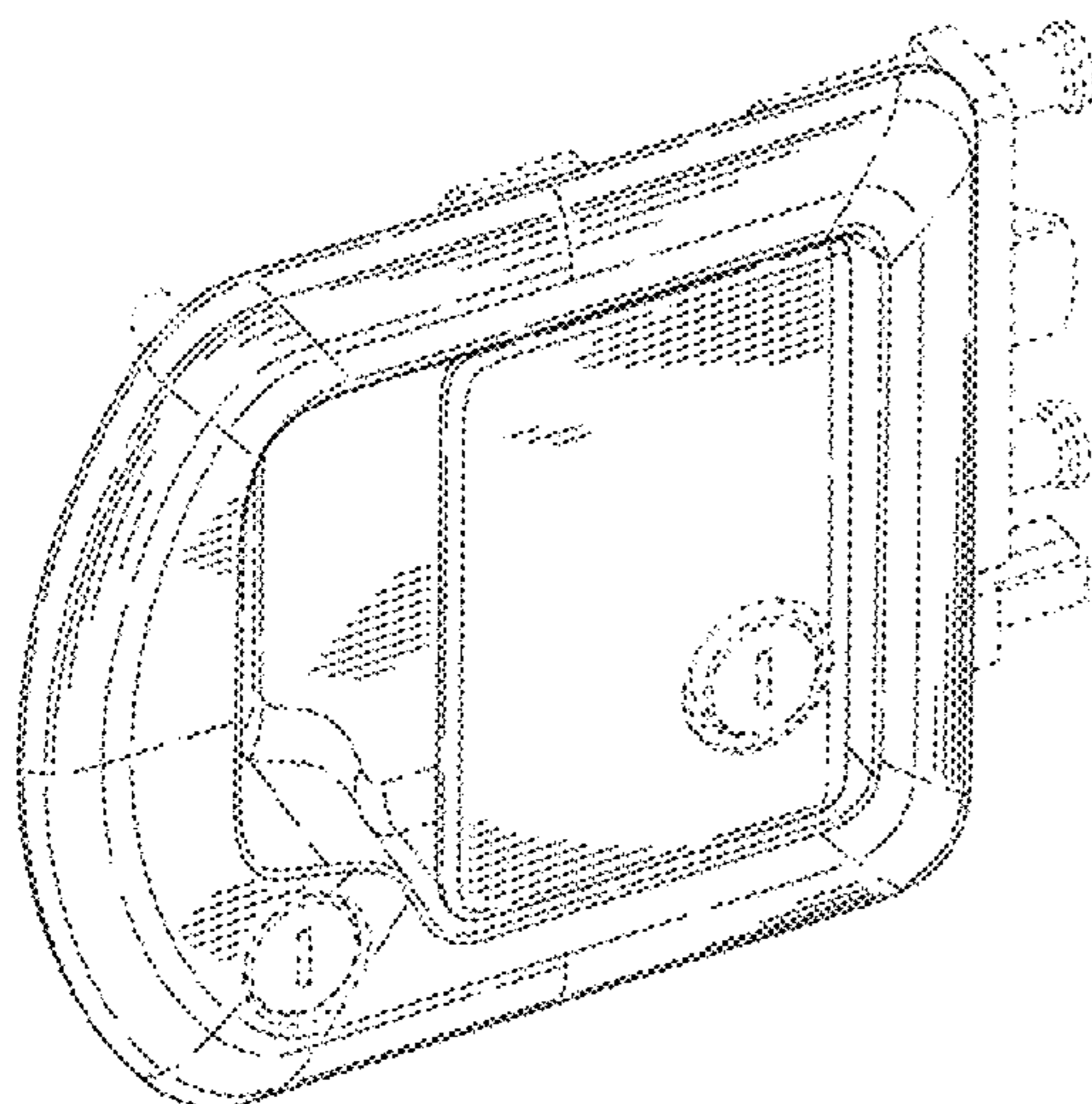

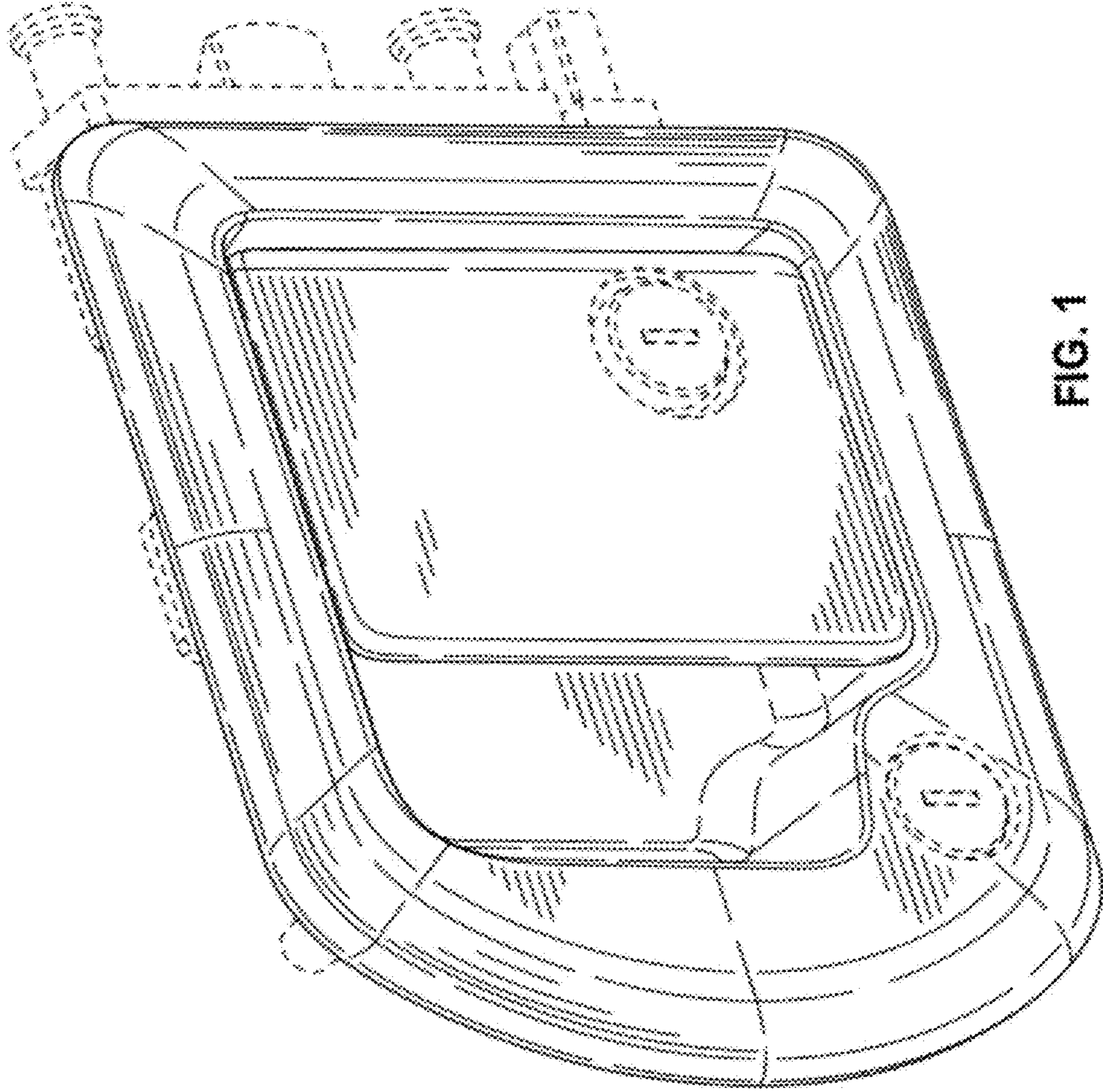

FIG. 1

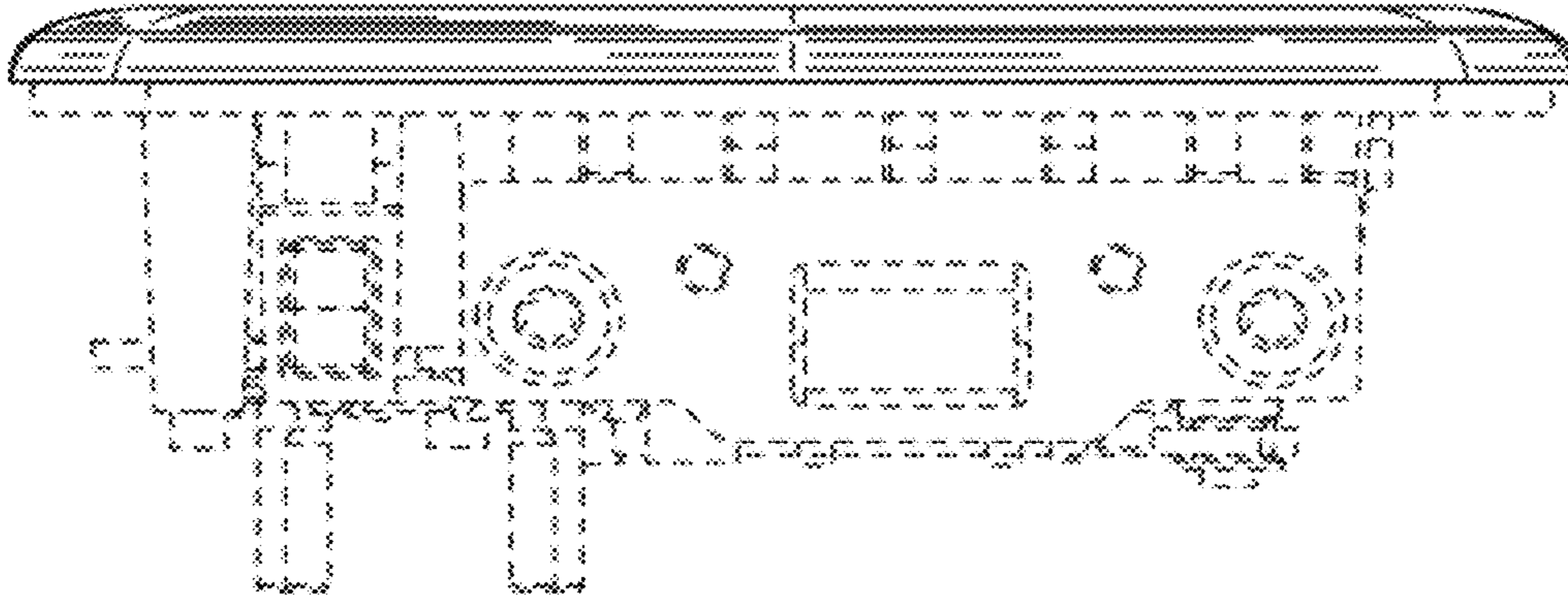

FIG. 2

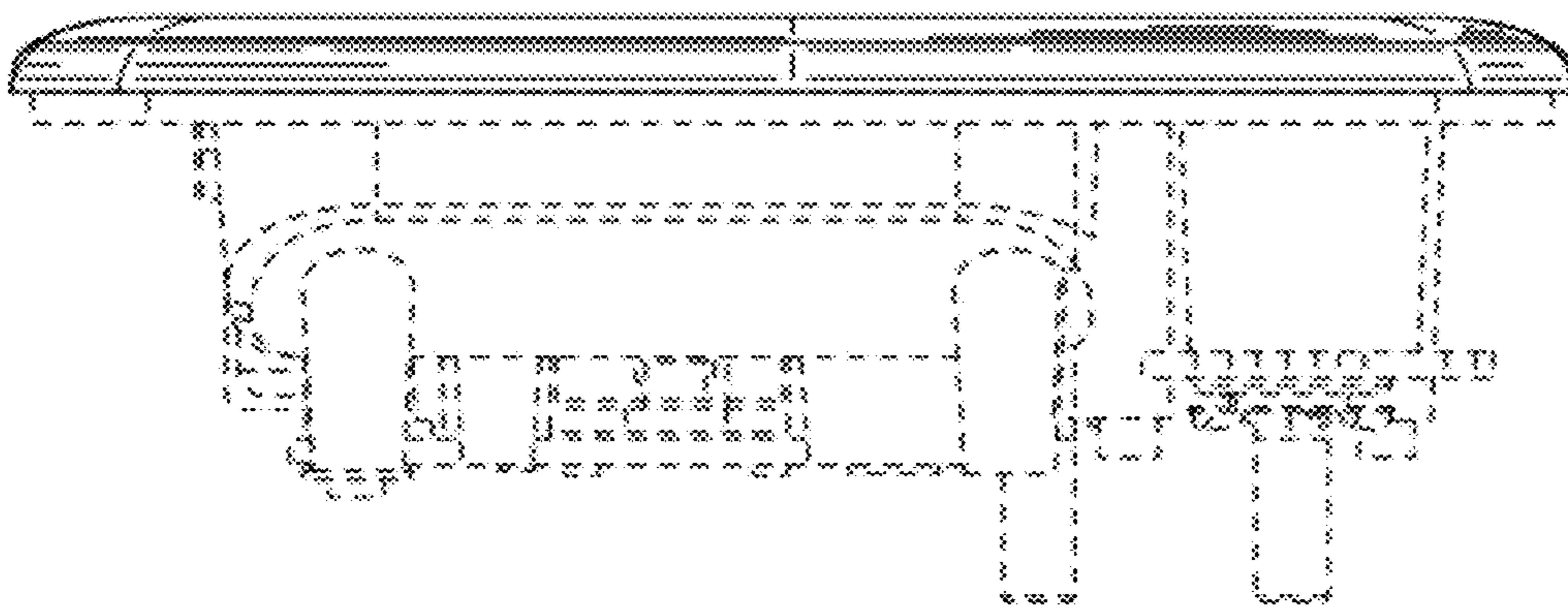

FIG. 3

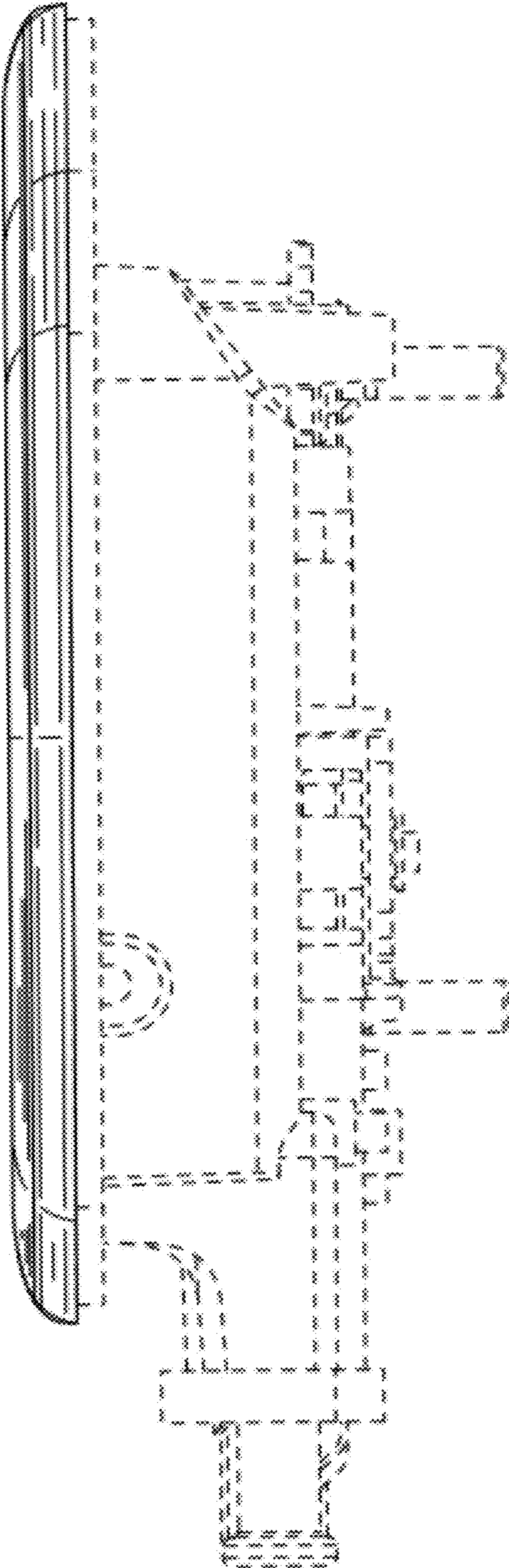

FIG. 4

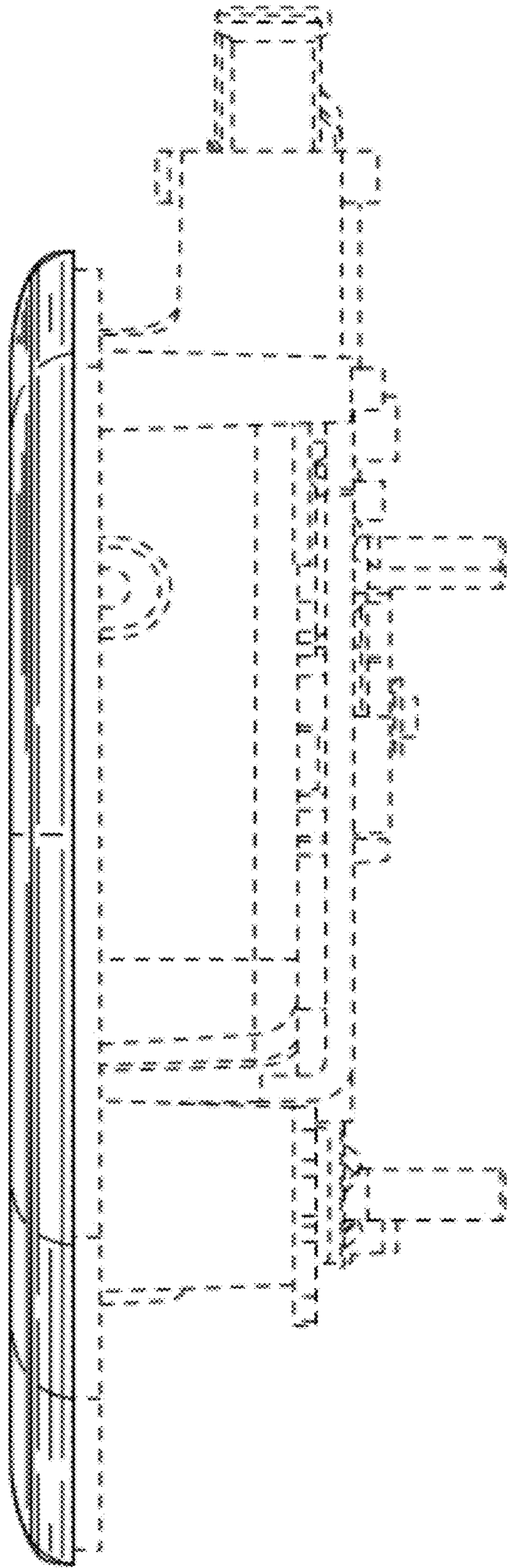

FIG. 5

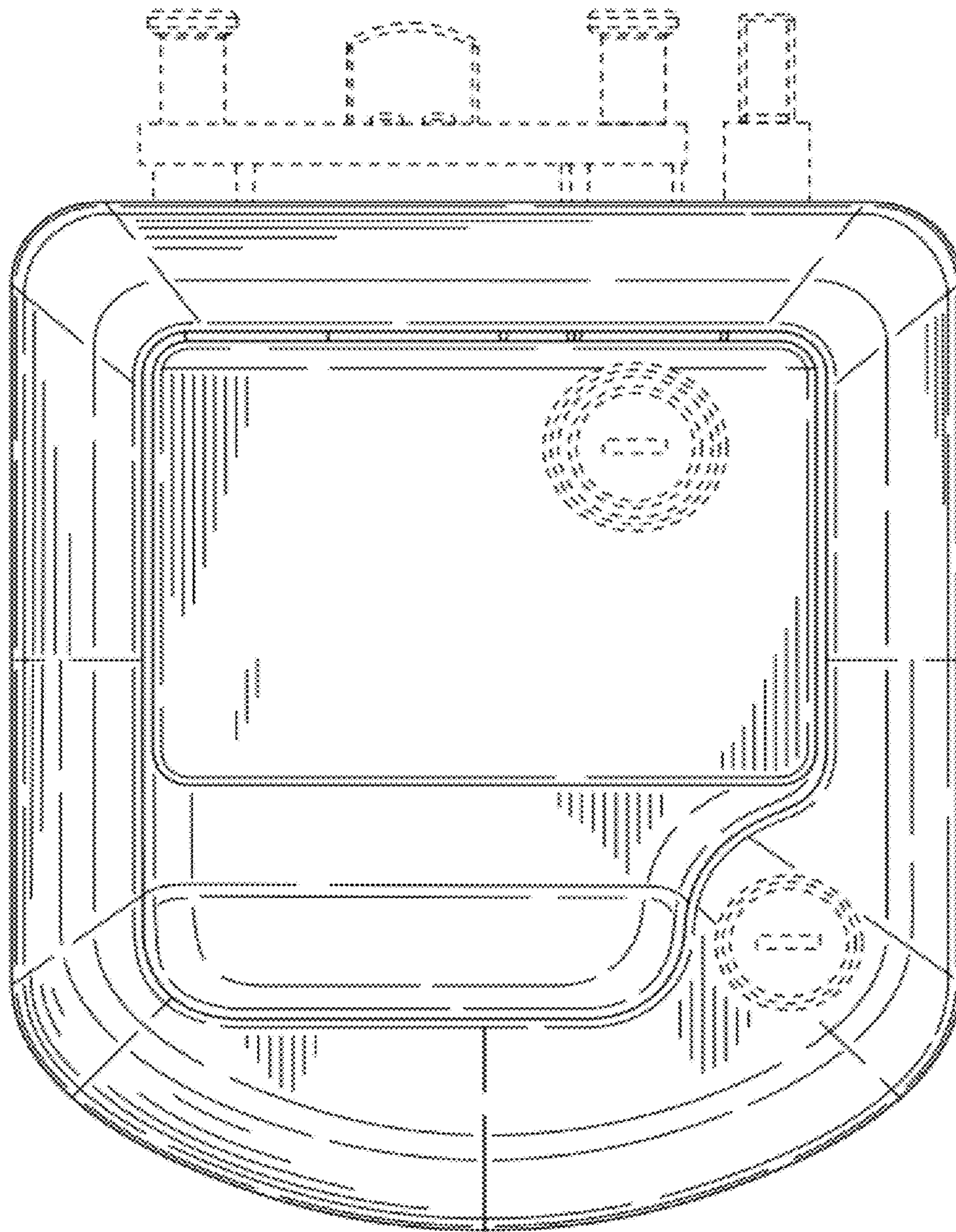

FIG. 6