



US00D674668S

(12) **United States Design Patent**
Hassanpour Aghdam

(10) **Patent No.:** **US D674,668 S**
(45) **Date of Patent:** **** Jan. 22, 2013**

(54) **UTENSIL WITH DETACHABLE DENTAL HYGIENE MECHANISM**

(76) Inventor: **Kamran Hassanpour Aghdam,**
Glendale, CA (US)

(**) Term: **14 Years**

(21) Appl. No.: **29/427,752**

(22) Filed: **Jul. 23, 2012**

(51) **LOC (9) Cl.** **07-03**

(52) **U.S. Cl.** **D7/643; D7/642; D7/645; D7/653**

(58) **Field of Classification Search** D4/108;
D28/65-68; D7/368, 393-395, 401.2, 505,
D7/642-646, 649-654, 660-664, 669, 675-676,
D7/683, 688-692, 695-696; 15/105; 30/137,
30/141-143, 147-150, 322-327, 329, 340,
30/342-344, 425; 132/323; 220/574.1, 735;
416/70 R, 75; 606/161

See application file for complete search history.

(56) **References Cited**

U.S. PATENT DOCUMENTS

2,634,497 A * 4/1953 Waldesbuehl 30/142
5,280,797 A * 1/1994 Fry 132/323
5,438,726 A * 8/1995 Leite 15/105
D374,744 S * 10/1996 Dolan et al. D28/68

(Continued)

Primary Examiner — Ricky Pham

(74) *Attorney, Agent, or Firm* — Marc Martino

(57) **CLAIM**

The ornamental design for a utensil with detachable dental hygiene mechanism, as shown and described.

DESCRIPTION

FIG. 1 is a perspective view of a utensil with detachable dental hygiene mechanism embodying my new design;
FIG. 2 is a bottom plan view thereof of FIG. 1;
FIG. 3 is a top plan view thereof of FIG. 1;
FIG. 4 is a front elevation view thereof of FIG. 1;
FIG. 5 is a rear elevation view thereof of FIG. 1;
FIG. 6 is a right side elevation view thereof of FIG. 1;
FIG. 7 is a left side elevation view thereof of FIG. 1;
FIG. 8 is a perspective view similar to FIG. 1, now illustrating a new embodiment thereof;
FIG. 9 is a bottom plan view thereof of FIG. 8;
FIG. 10 is a top plan view thereof of FIG. 8;
FIG. 11 is a front elevation view thereof of FIG. 8;
FIG. 12 is a rear elevation view thereof of FIG. 8;
FIG. 13 is a right side elevation view thereof of FIG. 8;
FIG. 14 is a left side elevation view thereof of FIG. 8;
FIG. 15 is a perspective view similar to FIGS. 1 and 8, now illustrating a new embodiment thereof;
FIG. 16 is a bottom plan view thereof of FIG. 15;
FIG. 17 is a top plan view thereof of FIG. 15;
FIG. 18 is a front elevation view thereof of FIG. 15;
FIG. 19 is a rear elevation view thereof of FIG. 15;
FIG. 20 is a right side elevation view thereof of FIG. 15; and,
FIG. 21 is a left side elevation view thereof of FIG. 15.
The broken lines shown in the drawings are for illustrative purposes only and form no part of the claimed design.

1 Claim, 18 Drawing Sheets

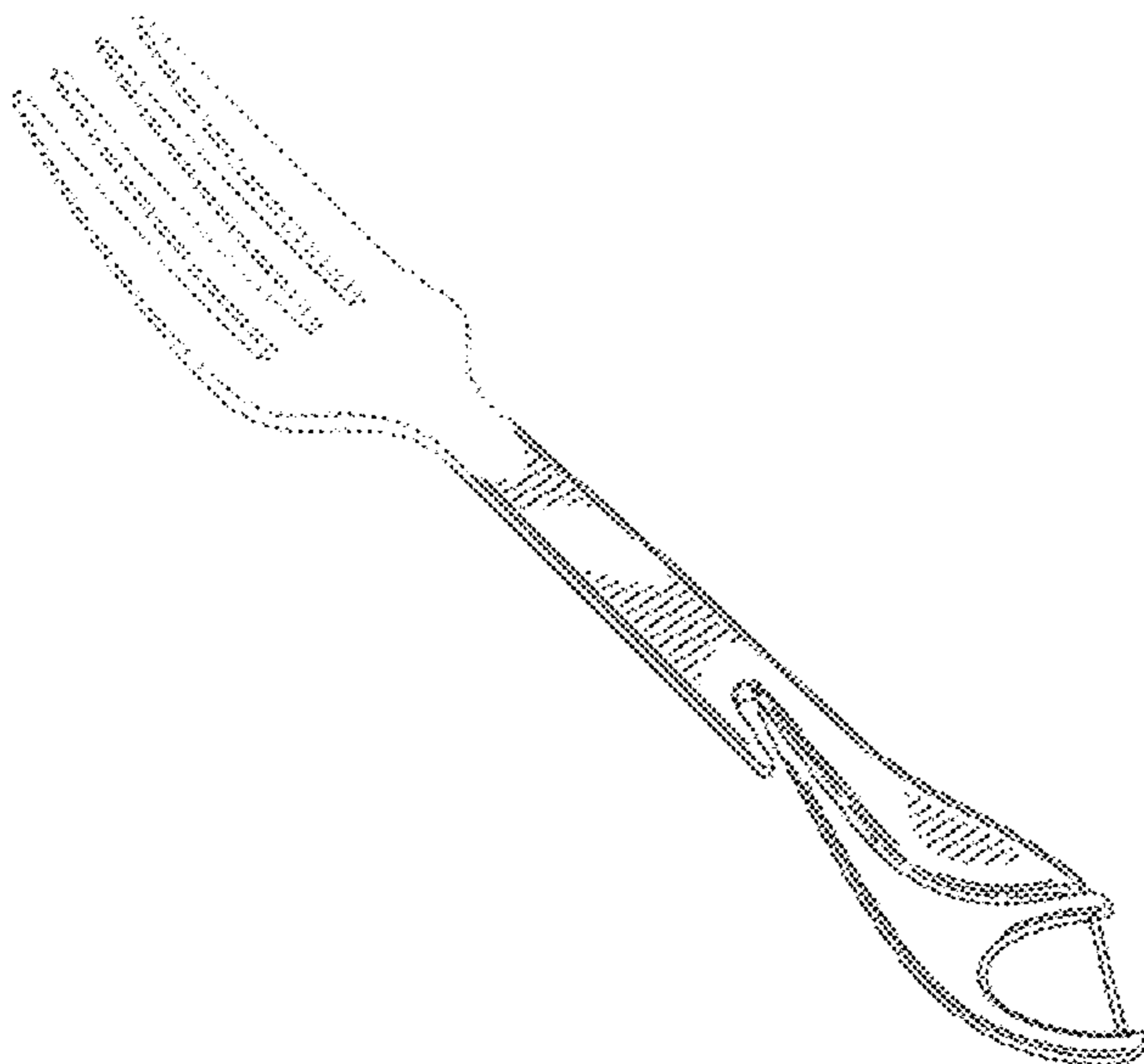

US D674,668 S

Page 2

U.S. PATENT DOCUMENTS

| | | | | | | | | | | | |
|-----------|------|---------|------------------|-------|---------|-----------|------|---------|------------------|-------|--------|
| 6,257,252 | B1 * | 7/2001 | Hall | | 132/323 | D582,098 | S * | 12/2008 | Jansheski et al. | | D28/66 |
| 6,440,149 | B1 * | 8/2002 | Potti | | 606/161 | 7,458,163 | B2 * | 12/2008 | Teich et al. | | 30/425 |
| D531,757 | S * | 11/2006 | Jansheski et al. | | D28/68 | D599,557 | S * | 9/2009 | Crossman | | D4/108 |
| D532,934 | S * | 11/2006 | Crossman | | D28/65 | D657,914 | S * | 4/2012 | Crossman | | D28/68 |
| D577,462 | S * | 9/2008 | Jansheski et al. | | D28/66 | | | | | | |

* cited by examiner

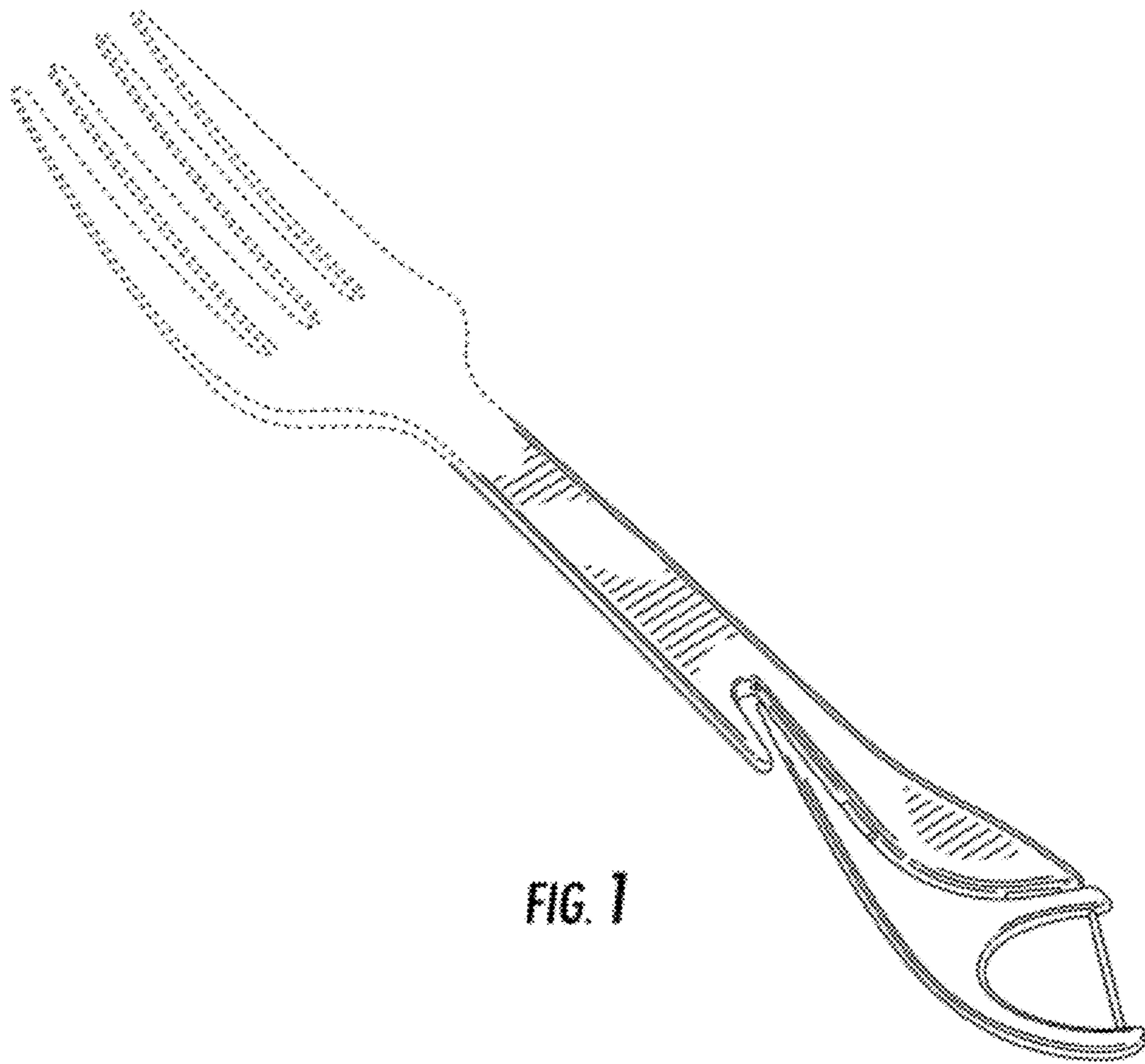

FIG. 1

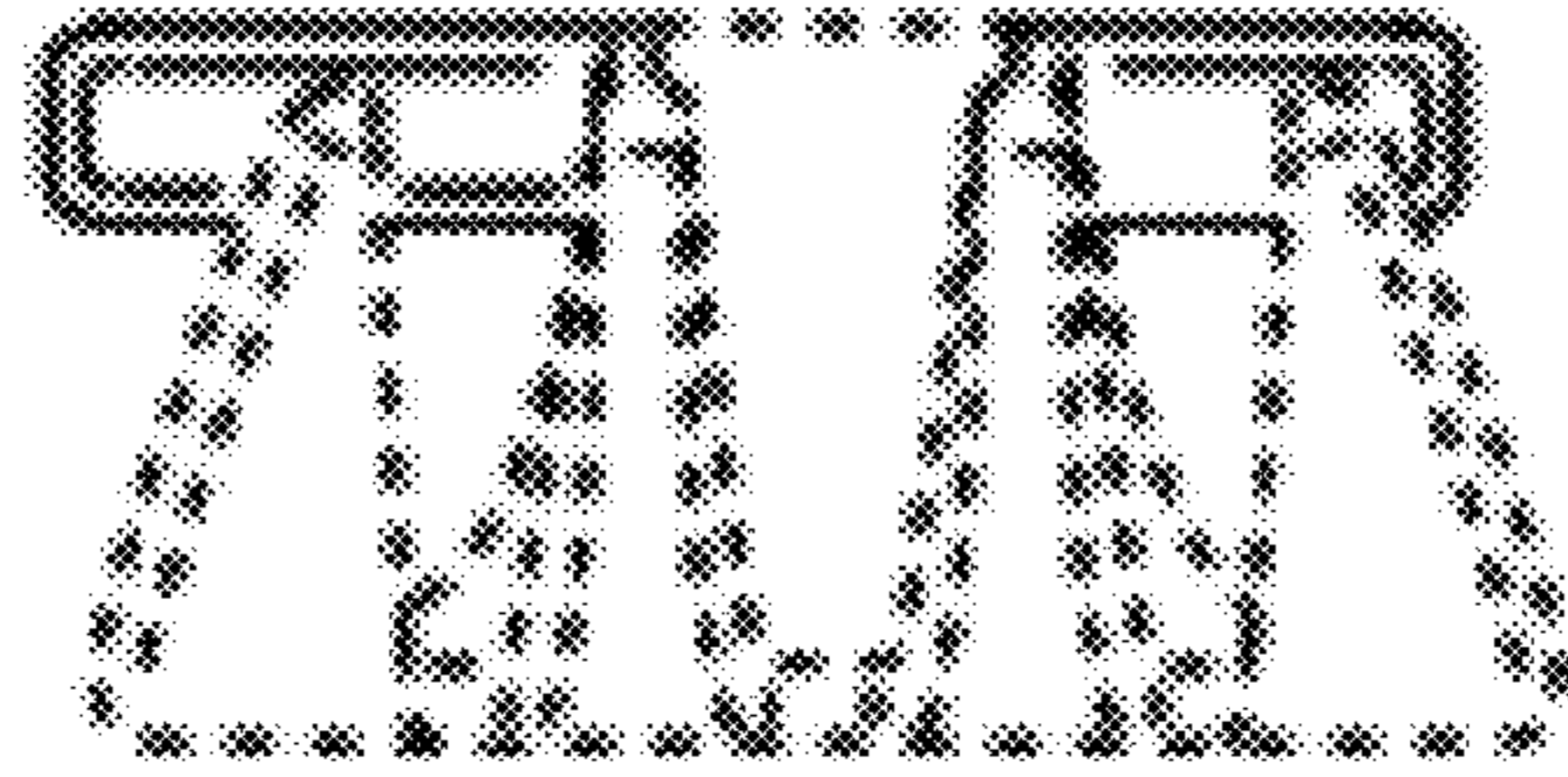

FIG. 2

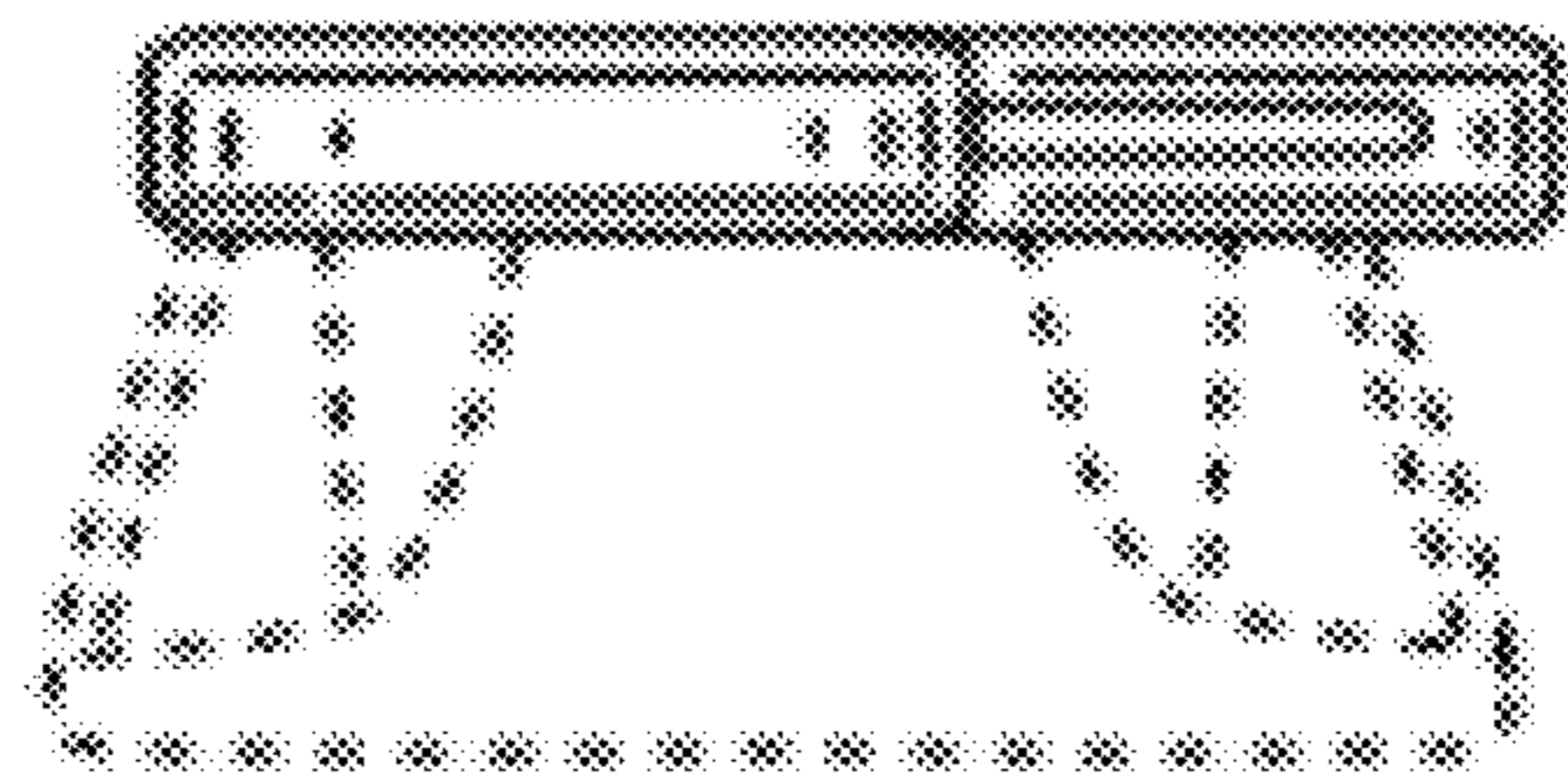

FIG. 3

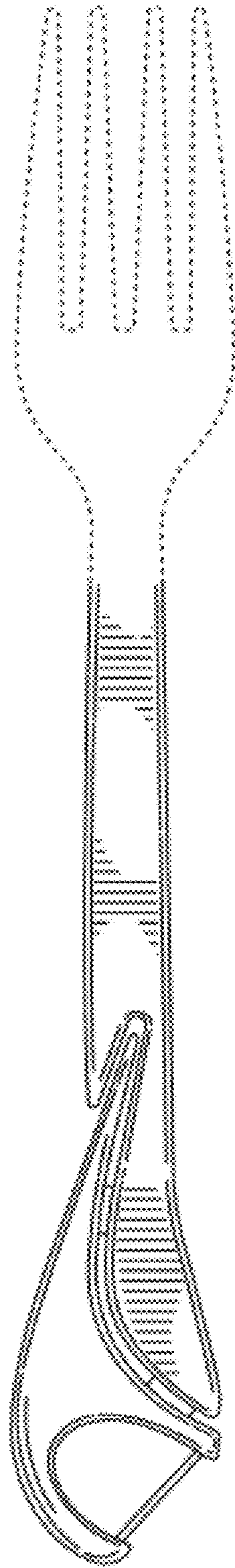

FIG. 4

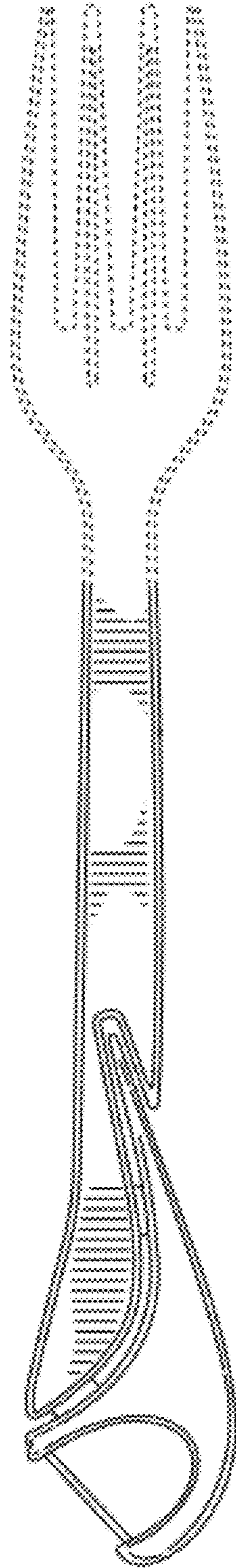

FIG. 5

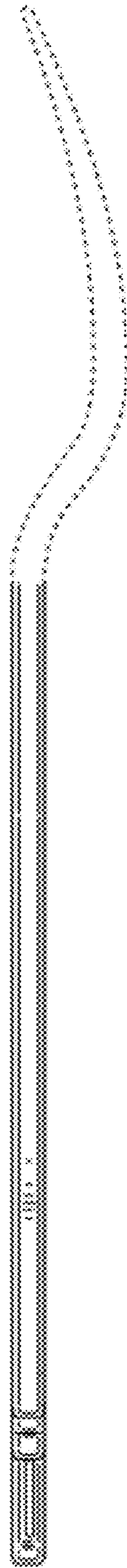

FIG. 6

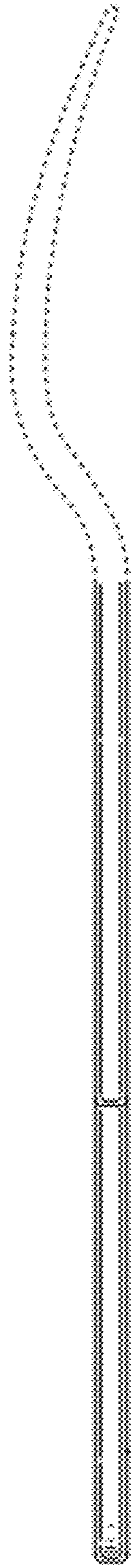

FIG. 7

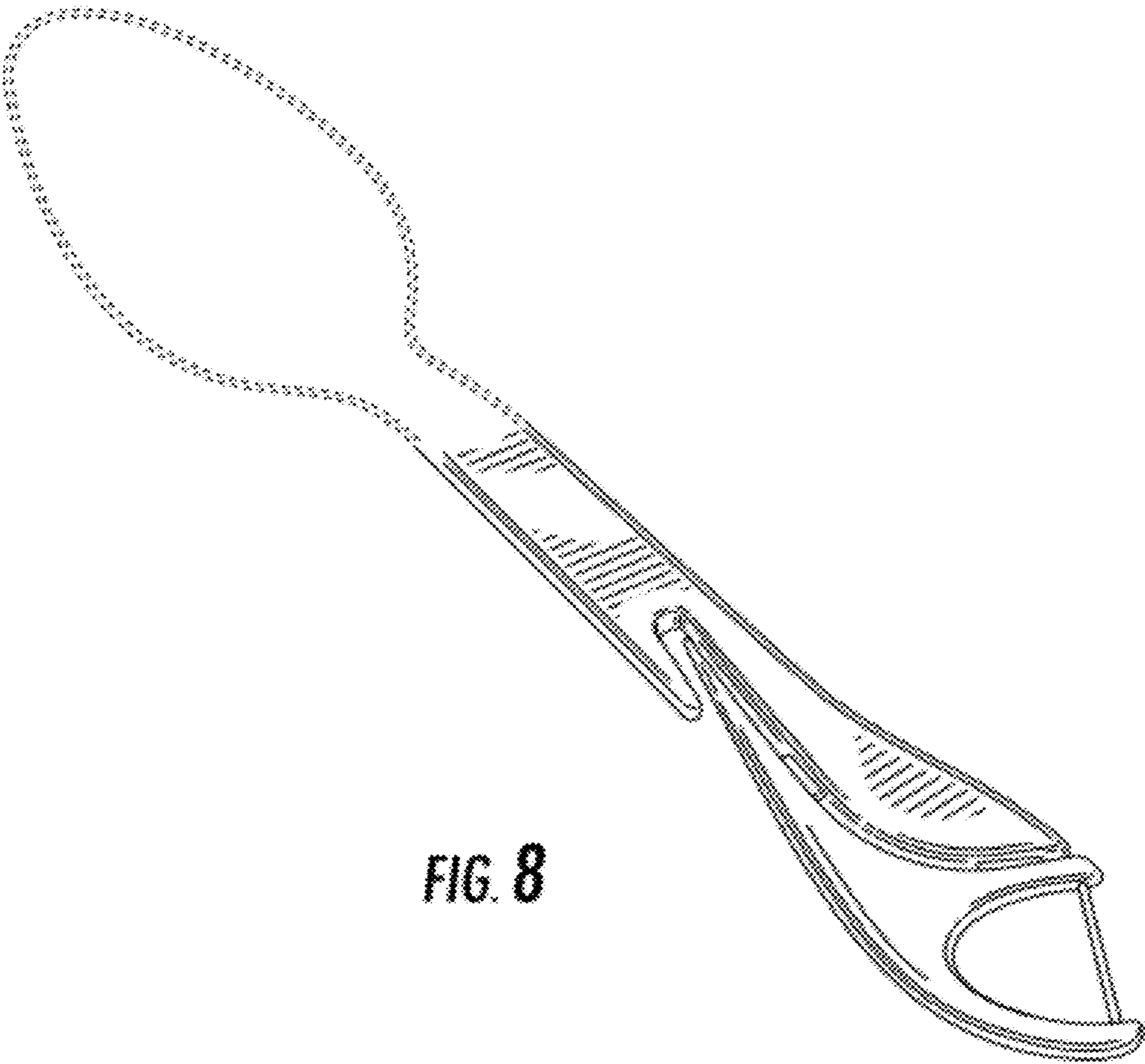

FIG. 8

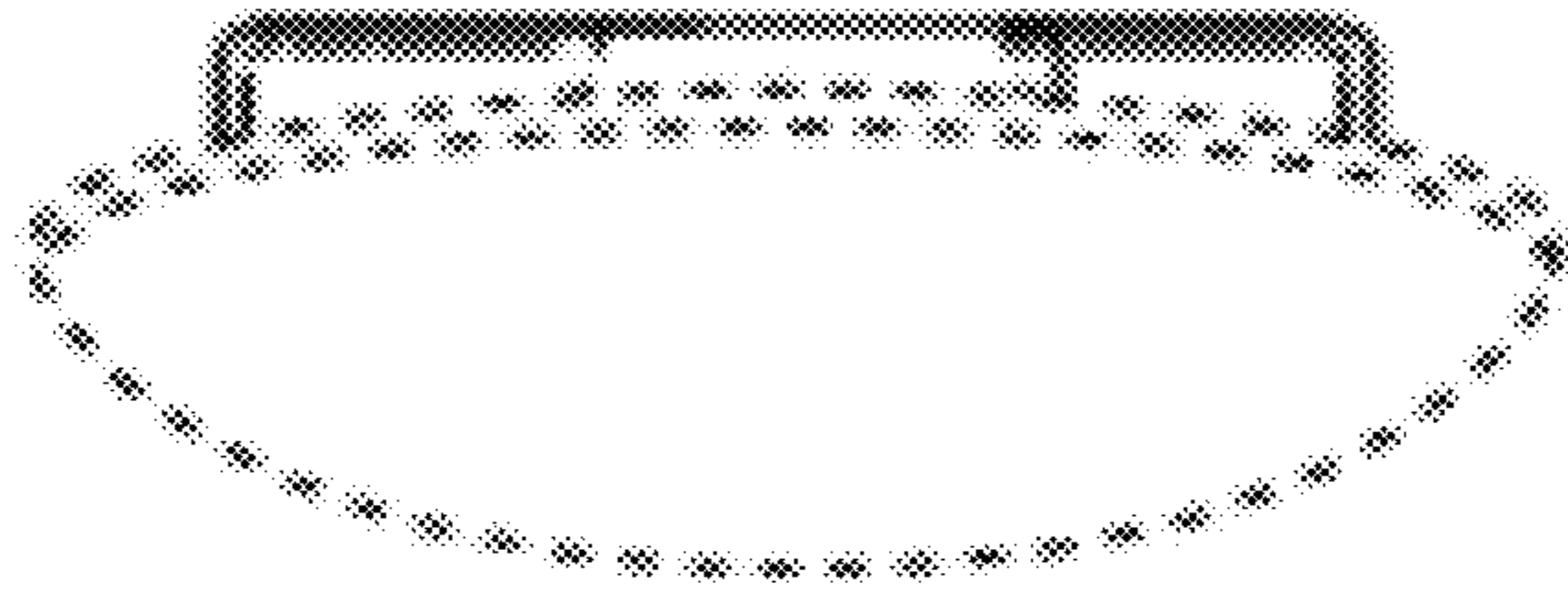

FIG. 9

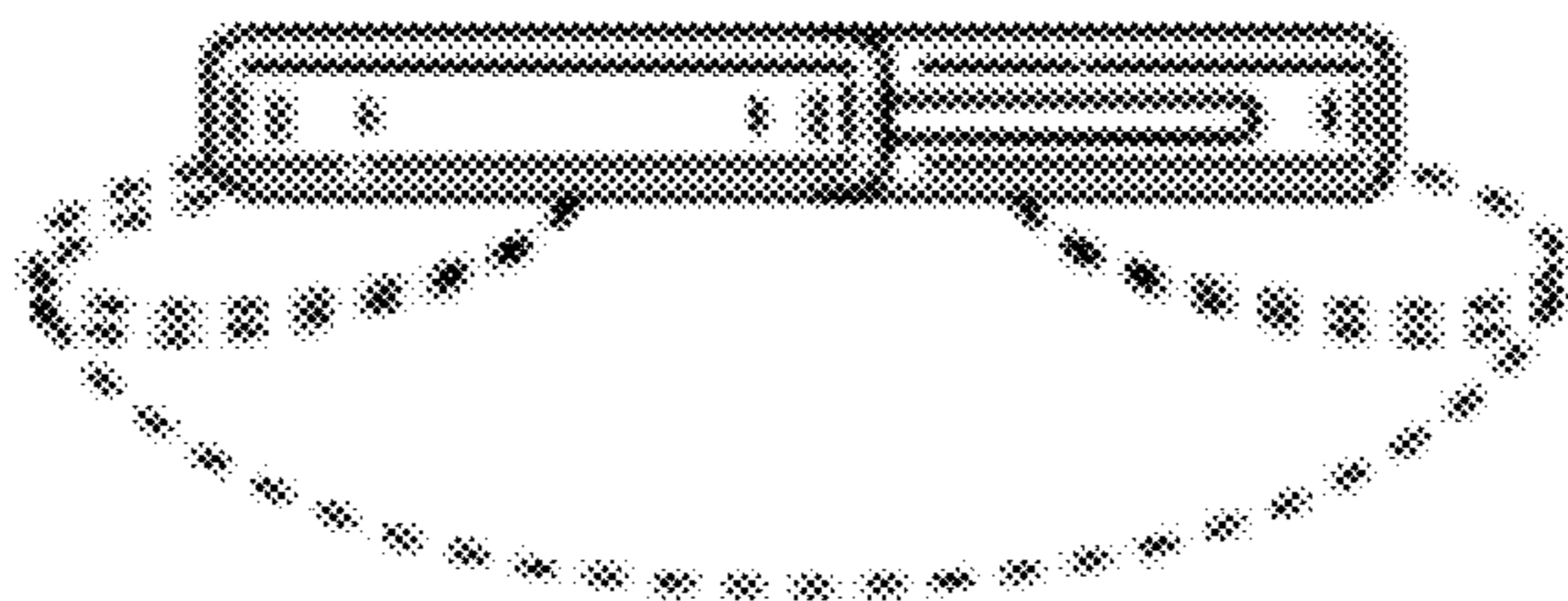

FIG. 10

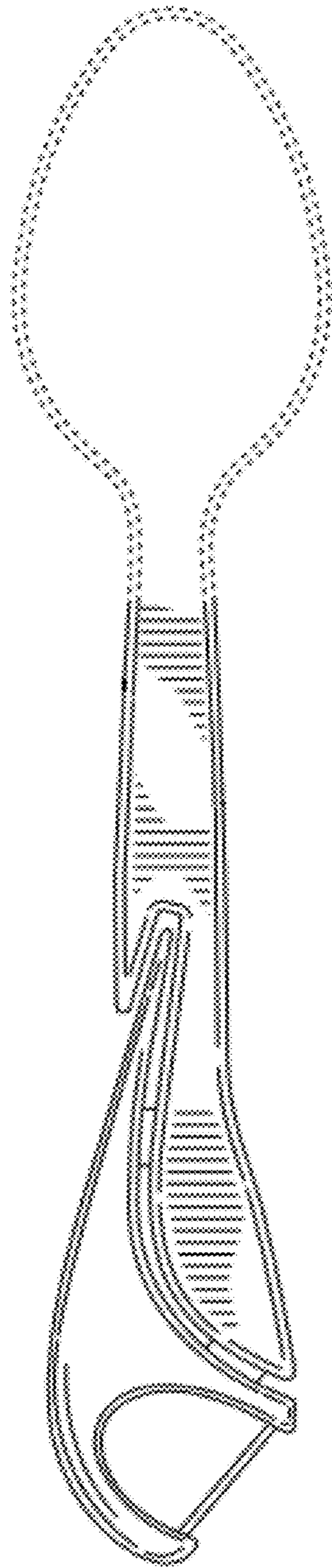

FIG. 11

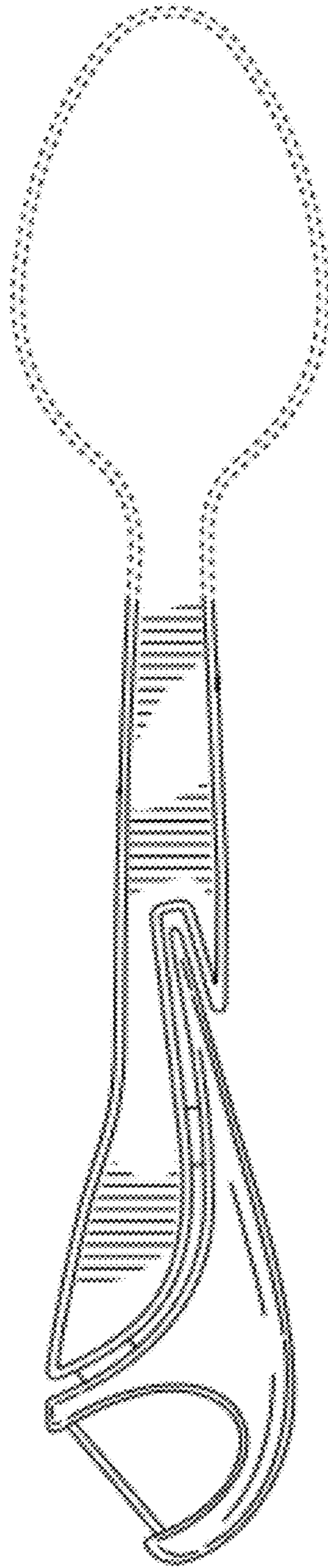

FIG. 12

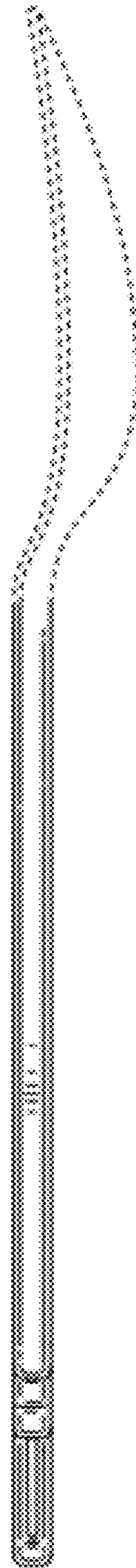

FIG. 13

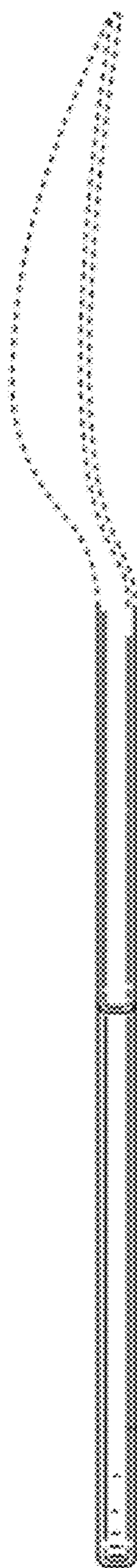

FIG. 14

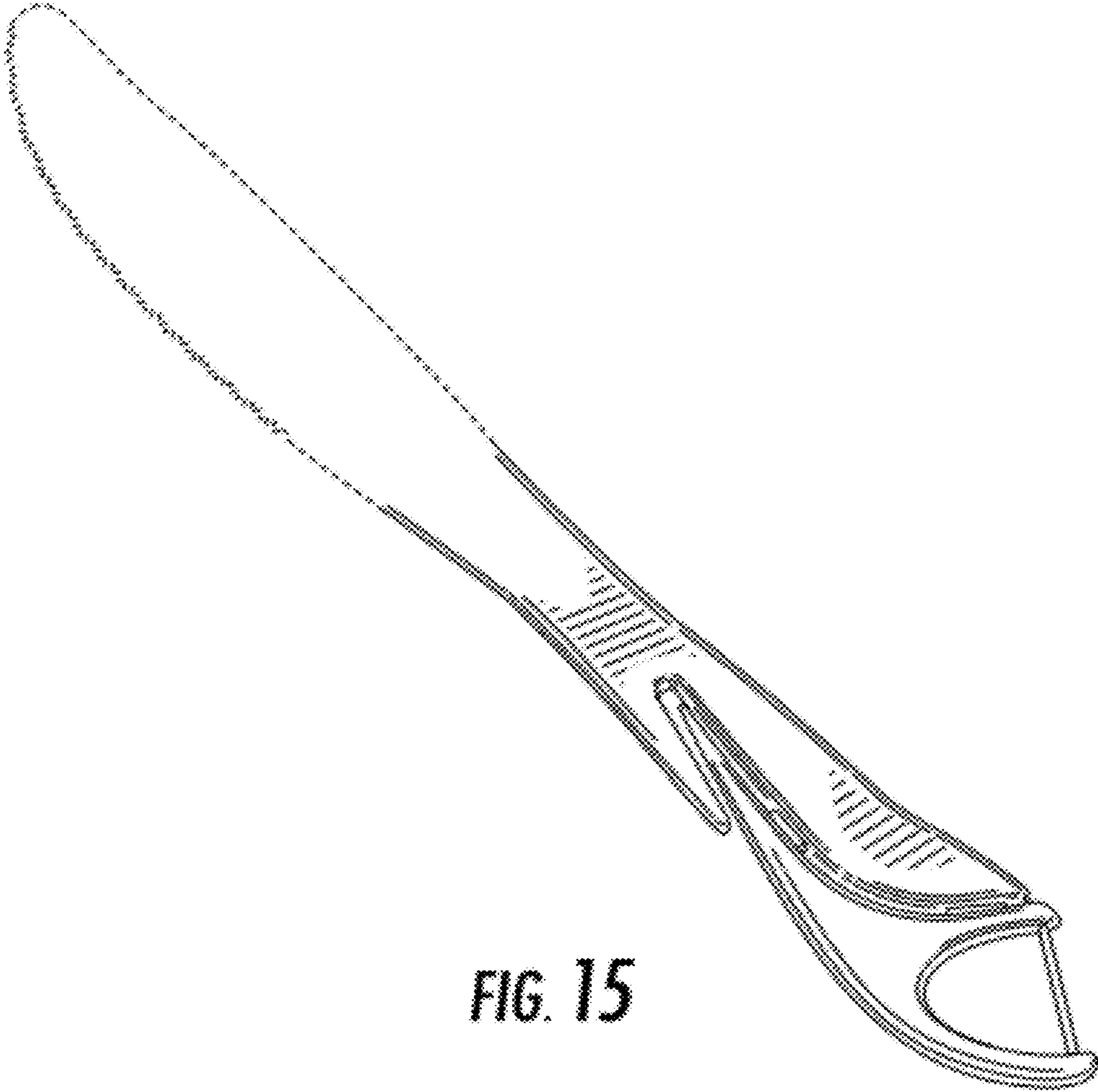

FIG. 15



FIG. 16

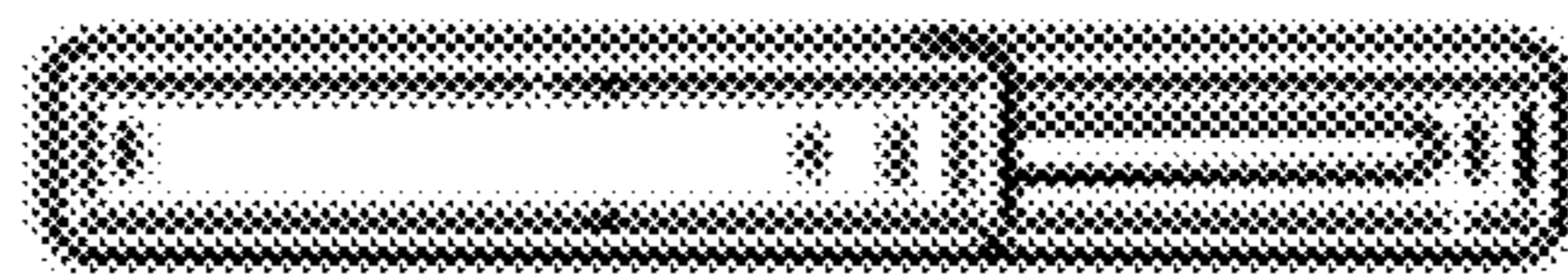

FIG. 17

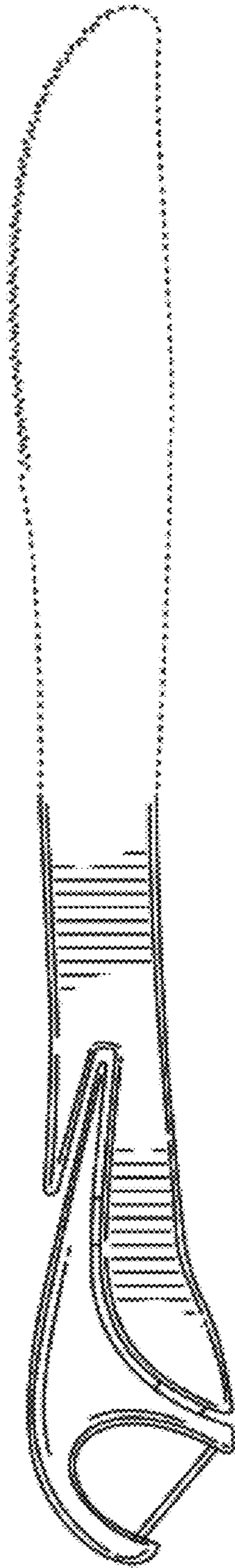

FIG. 18

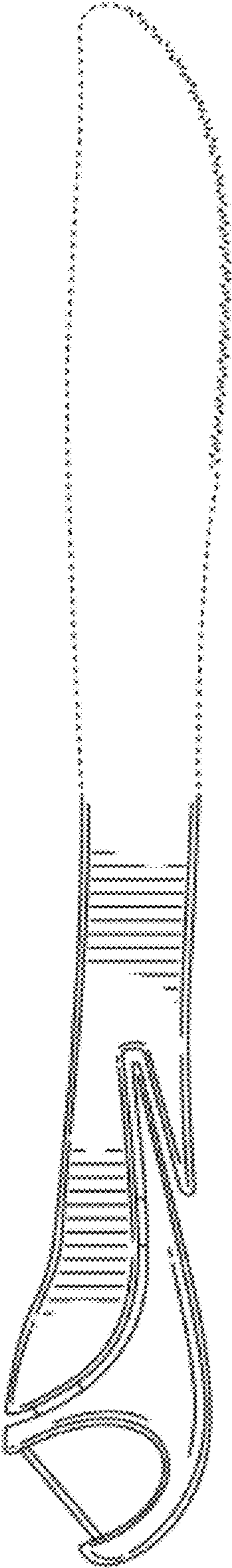

FIG. 19



FIG. 20



FIG. 21