



US00D674620S

(12) **United States Design Patent**
Petrick et al.

(10) **Patent No.:** **US D674,620 S**
(45) **Date of Patent:** **** Jan. 22, 2013**

(54) **ELECTRONIC DEVICE STORAGE TRAY**

(75) Inventors: **Christopher Petrick**, Park Ridge, IL (US); **Matthew Petrick**, Oak Park, IL (US); **Tad Petrick**, Evanston, IL (US); **Jim Fisher**, Waukegan, IL (US); **Stewart Long**, Des Plaines, IL (US); **Chris Brandel**, Chicago, IL (US)

(73) Assignee: **Bretford Manufacturing**, Franklin Park

(**) Term: **14 Years**

(21) Appl. No.: **29/412,420**

(22) Filed: **Feb. 2, 2012**

(51) **LOC (9) Cl.** **06-06**

(52) **U.S. Cl.** **D6/407**

(58) **Field of Classification Search** D3/407,
D3/626-635; D19/26-27; D14/478-479;
206/307, 307.1, 308.1, 309-313, 308.2-308.3,
206/445, 387.15, 749-751; 312/9.1, 9.9,
312/9.48, 9.55, 9.64, 9.47, 9.53; D9/414-415,
D9/418, 420, 422-426, 432-433

See application file for complete search history.

(56) **References Cited**

U.S. PATENT DOCUMENTS

4,684,027 A * 8/1987 Wright 211/40
D427,835 S * 7/2000 Tisbo D6/629
D440,809 S * 4/2001 Hunt D6/629
D485,725 S * 1/2004 Real D6/629

D489,556 S * 5/2004 Mason D6/511
D524,586 S * 7/2006 Menard D6/629
D530,117 S * 10/2006 Nomoto D6/474
D552,399 S * 10/2007 Jaricot D6/629
D554,929 S * 11/2007 Jajdelski D6/629
D660,650 S * 5/2012 Moore D7/553.2
D661,126 S * 6/2012 Hester D6/407

* cited by examiner

Primary Examiner — Kelley Donnelly

(74) *Attorney, Agent, or Firm* — Anderson Gorecki & Rouille LLP

(57) **CLAIM**

The ornamental design for a electronic device storage tray, as shown and described.

DESCRIPTION

FIG. 1 is a front perspective view of an electronic device storage tray;
FIG. 2 is a front view of the electronic device storage tray of FIG. 1;
FIG. 3 is a rear view of the electronic device storage tray of FIG. 1;
FIG. 4 is a top plan view of the electronic device storage tray of FIG. 1;
FIG. 5 is a bottom plan view of the electronic device storage tray of FIG. 1;
FIG. 6 is a left view of the electronic device storage tray of FIG. 1; and,
FIG. 7 is a right view of the electronic device storage tray of FIG. 1.

The broken lines shown in the drawings are for illustrative purposes only and form no part of the claimed design.

1 Claim, 7 Drawing Sheets

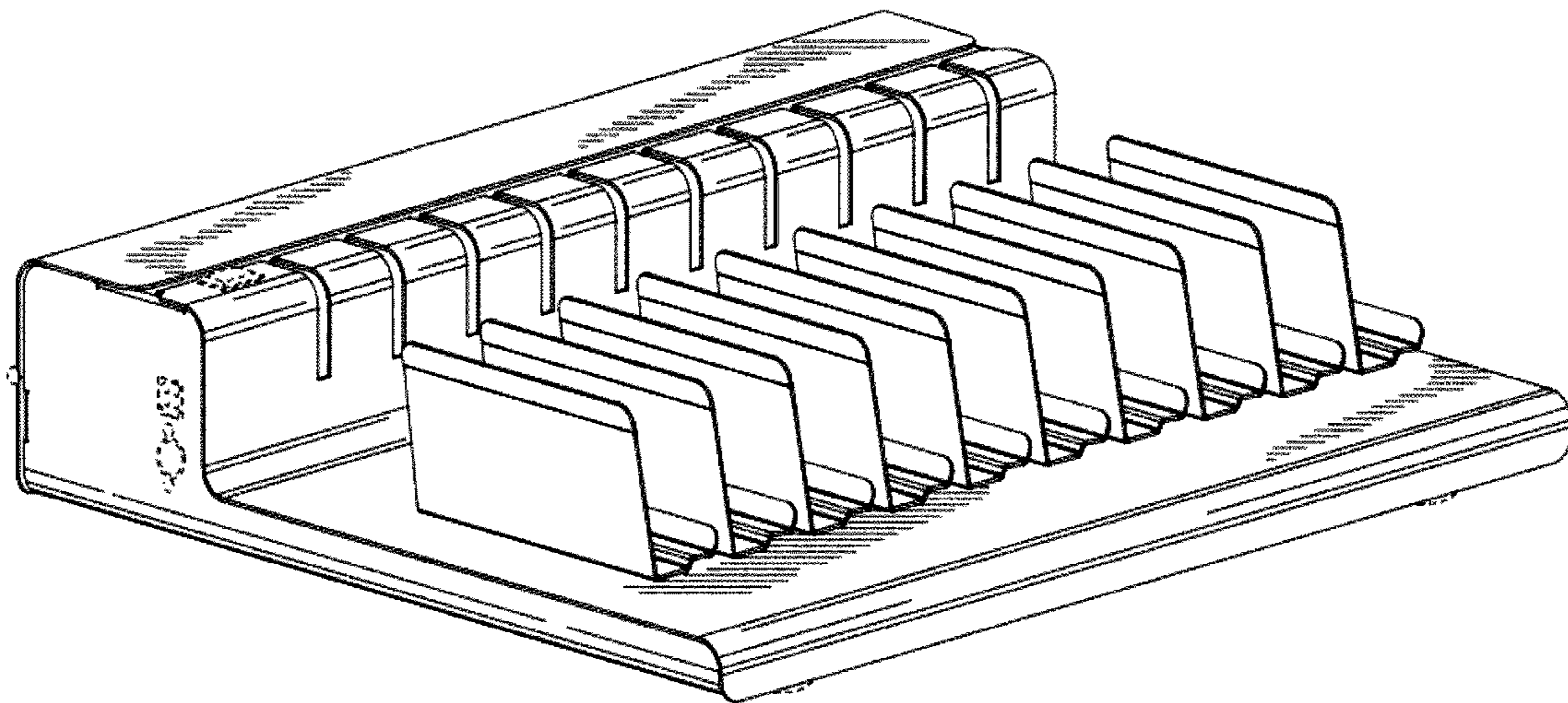

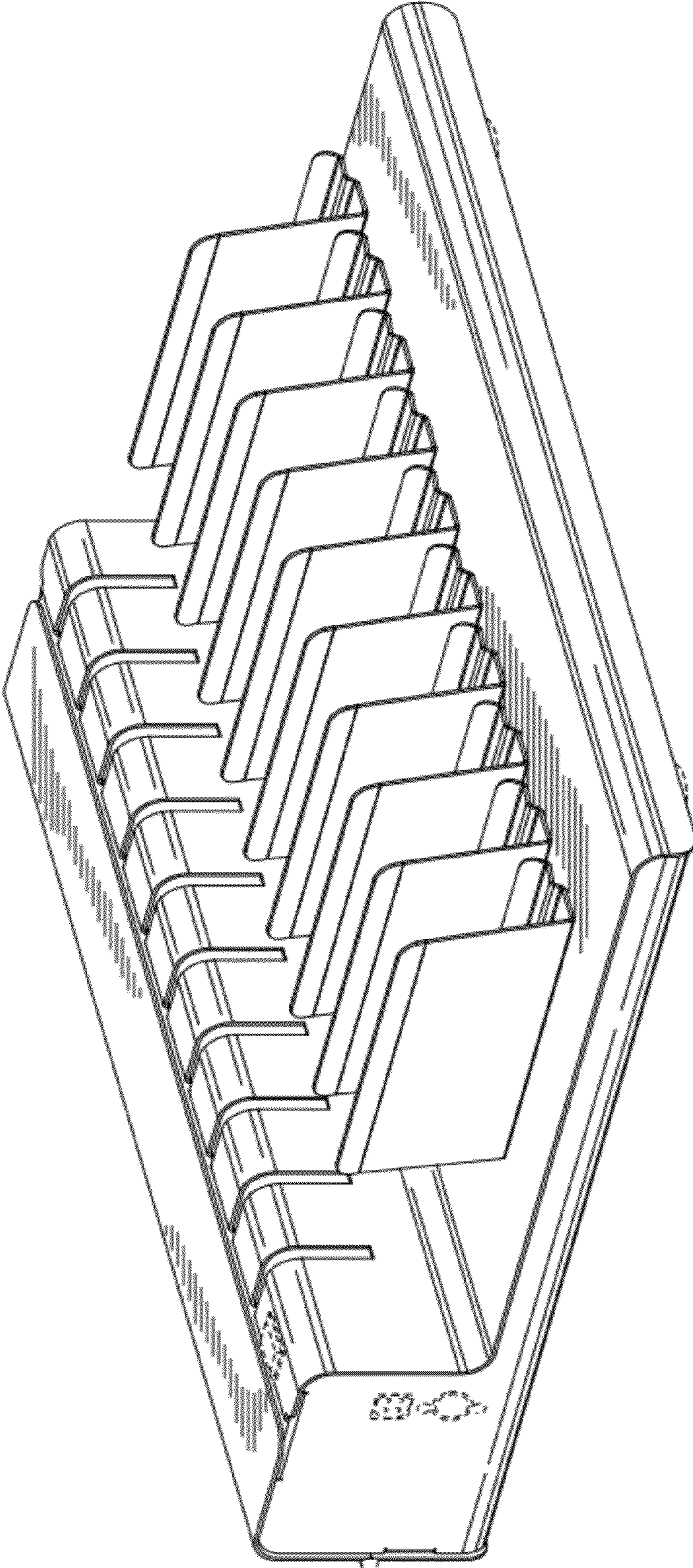

FIG. 1

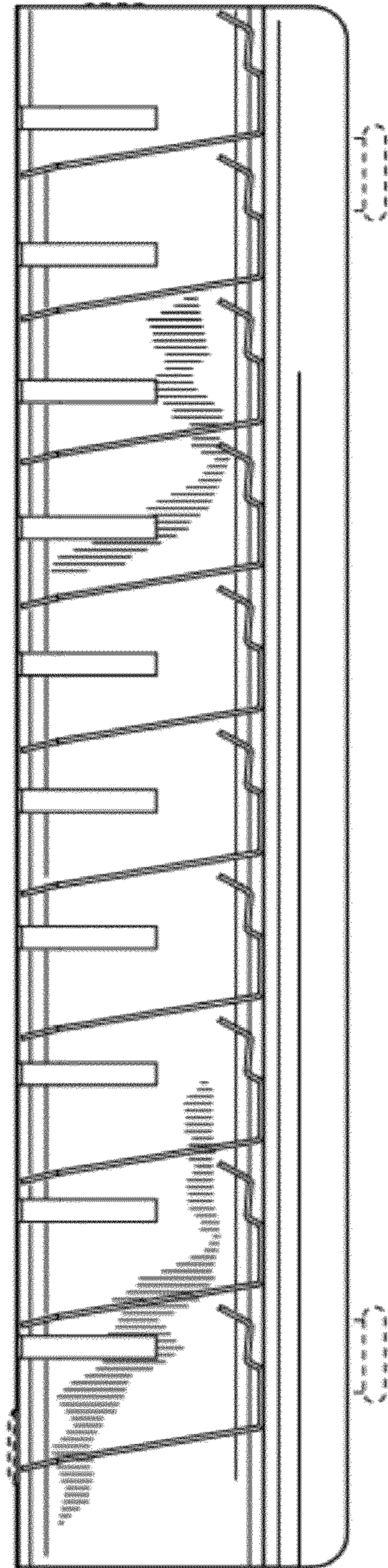

FIG. 2

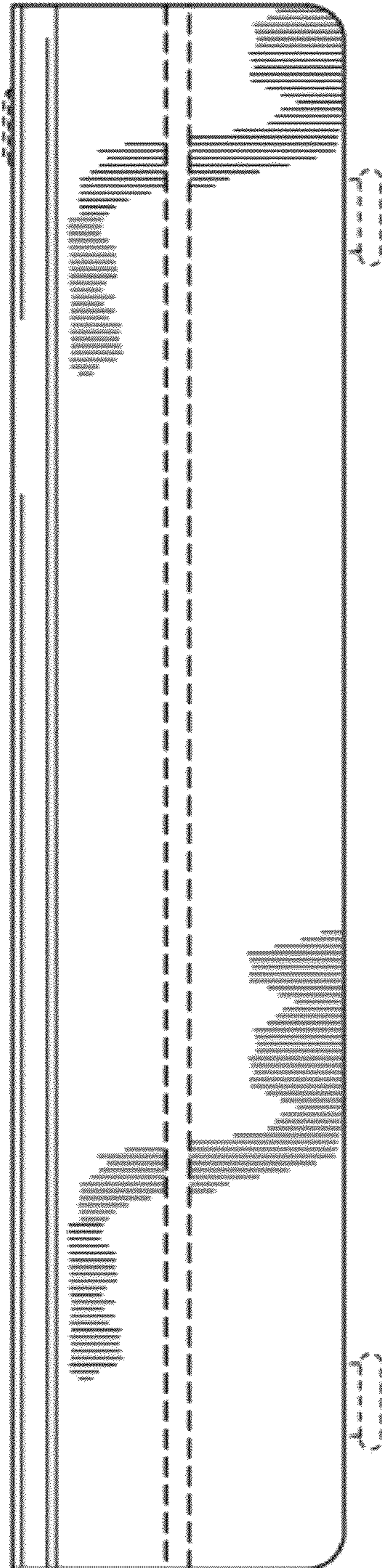

FIG. 3

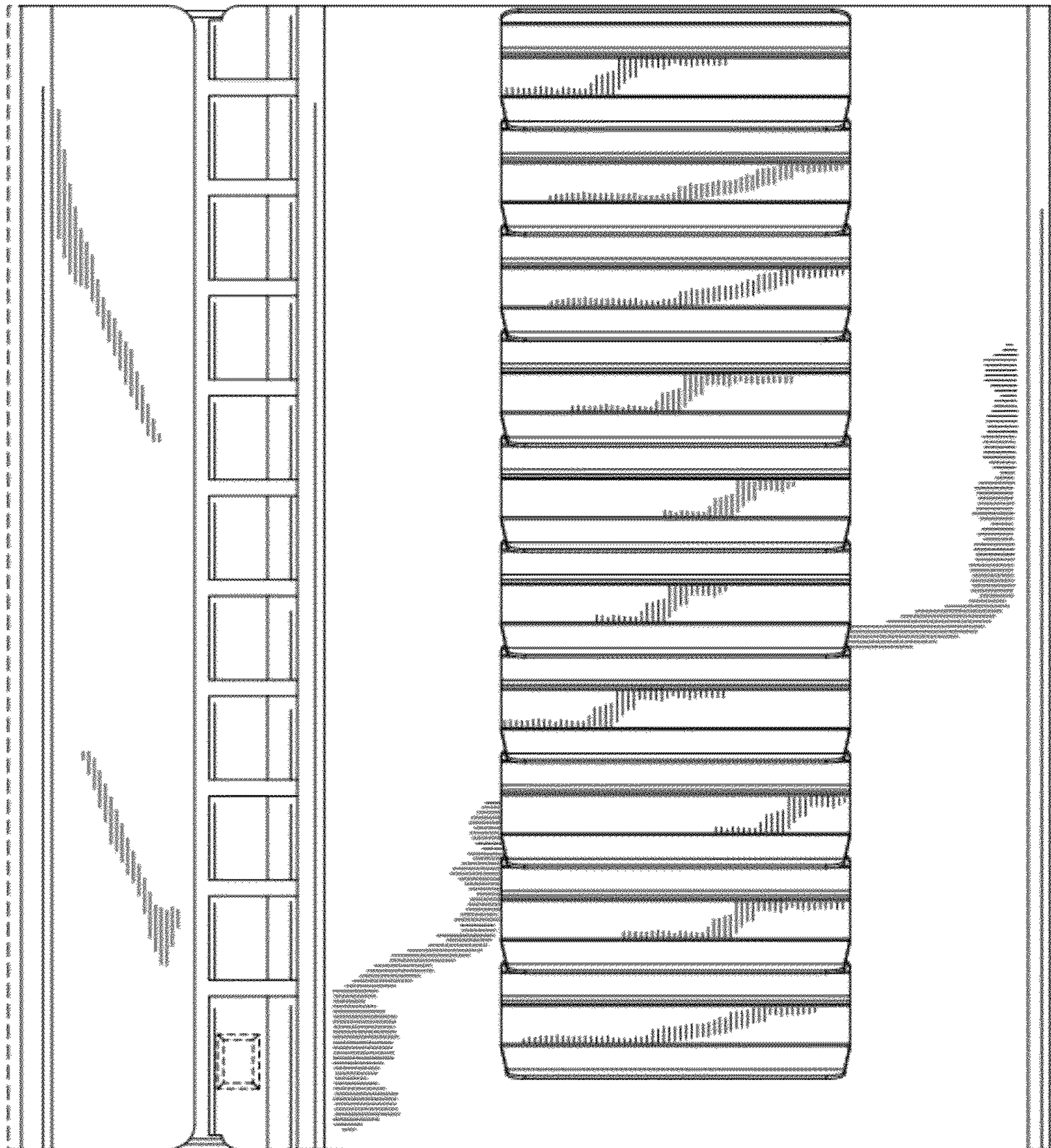

FIG. 4

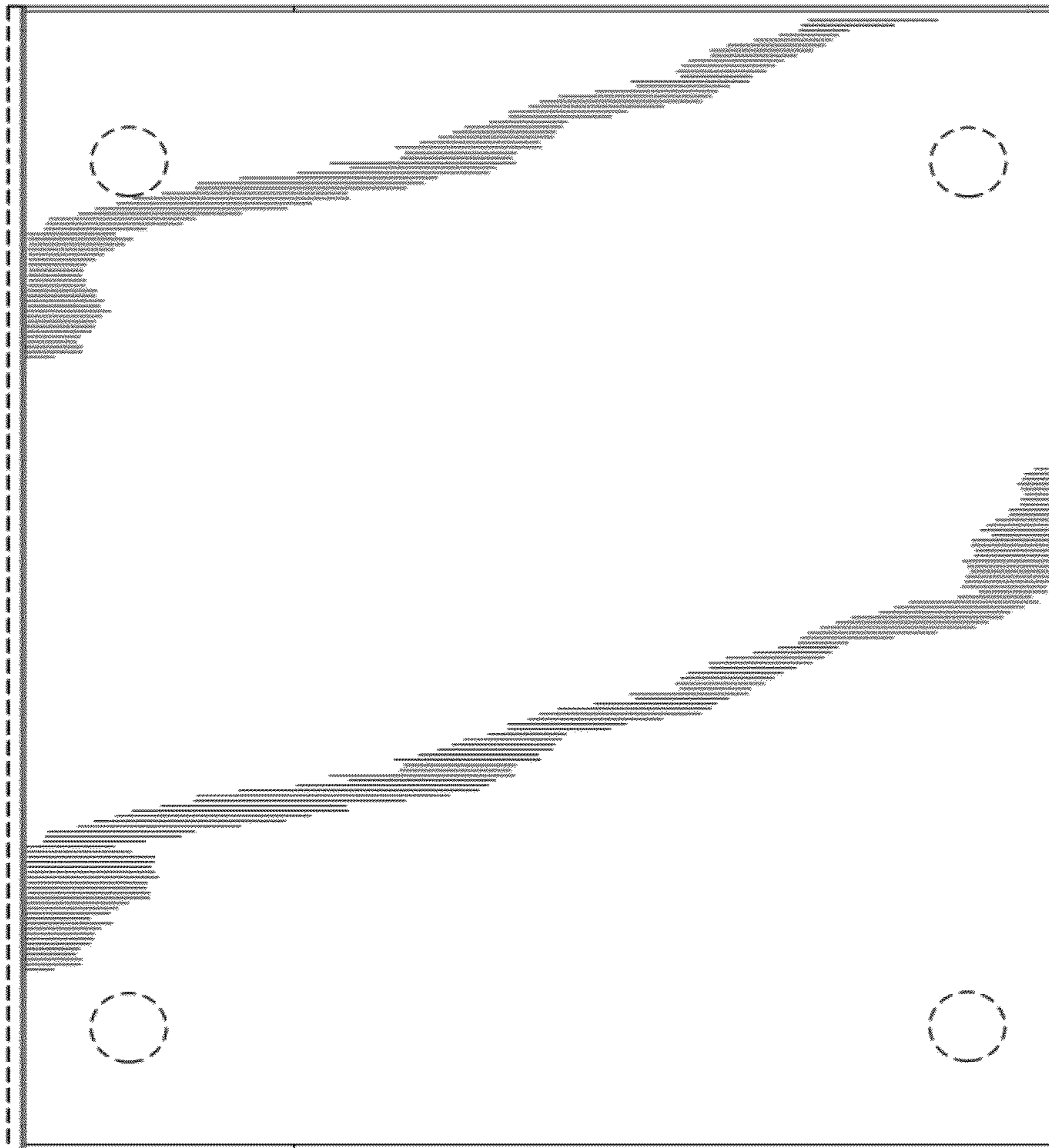

FIG. 5

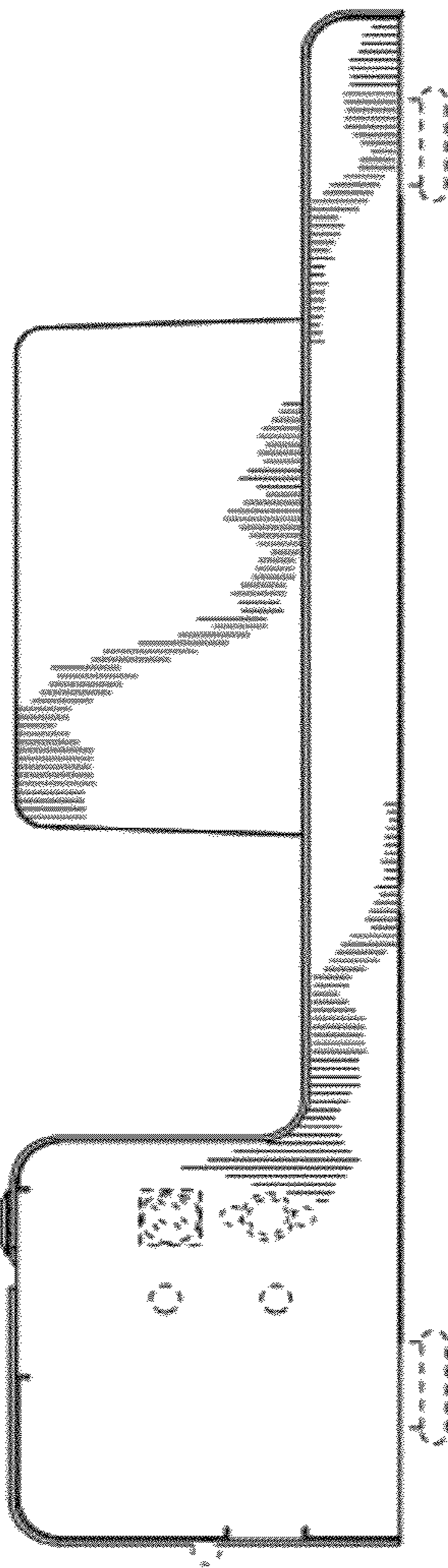

FIG. 6

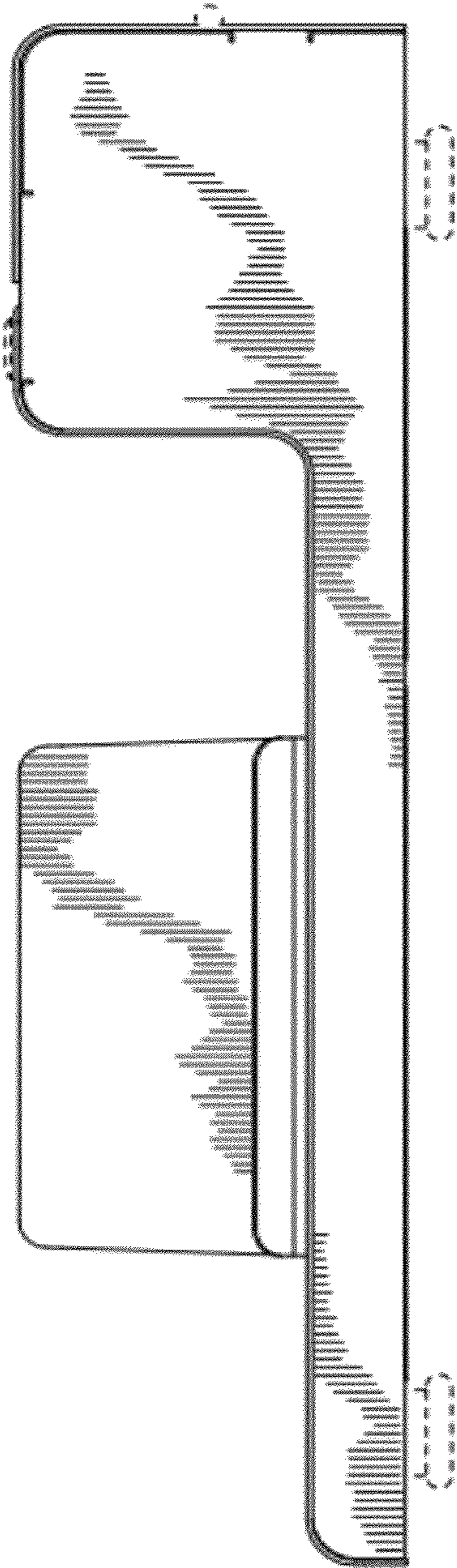

FIG. 7