



US00D674436S

(12) **United States Design Patent**
Takada et al.

(10) **Patent No.:** **US D674,436 S**
(45) **Date of Patent:** **** Jan. 15, 2013**

(54) **INK TANK FOR PRINTER**

(75) Inventors: **Hitoshi Takada**, Yokohama (JP); **Koichi Kubo**, Yokohama (JP); **Takeho Miyashita**, Kawasaki (JP); **Hiroki Hayashi**, Kawasaki (JP); **Yasuhiro Morishita**, Tokyo (JP); **Hitomi Ogasawara**, Yokohama (JP)

(73) Assignee: **Canon Kabushiki Kaisha**, Tokyo (JP)

(**) Term: **14 Years**

(21) Appl. No.: **29/398,498**

(22) Filed: **Aug. 1, 2011**

(30) **Foreign Application Priority Data**

Feb. 10, 2011 (JP) 2011-002841

(51) **LOC (9) Cl.** **18-02**

(52) **U.S. Cl.** **D18/56**

(58) **Field of Classification Search** D18/12,
D18/40, 43, 56; 347/86-67

See application file for complete search history.

(56) **References Cited**

U.S. PATENT DOCUMENTS

D419,593 S * 1/2000 Shimizu et al. D18/56
D438,897 S * 3/2001 Hatasa et al. D18/56
6,276,789 B1 * 8/2001 Miyazaki et al. 347/86
D448,798 S * 10/2001 Shimizu et al. D18/56

D462,089 S * 8/2002 Trafton et al. D18/56
D490,102 S * 5/2004 Umeyama et al. D18/56
D525,652 S * 7/2006 Hegge D18/56
D530,365 S * 10/2006 Wakayama et al. D18/56
D531,664 S * 11/2006 Hegge D18/56
D542,345 S 5/2007 Hayashi et al. D18/56
D548,780 S 8/2007 Hayashi et al. D18/56
D587,749 S * 3/2009 Perrill et al. D18/56
D611,532 S 3/2010 Nanjo et al. D18/56
D624,960 S 10/2010 Inoue et al. D18/56
D626,173 S 10/2010 Inoue et al. D18/56

* cited by examiner

Primary Examiner — Cathy A MacCormac

(74) *Attorney, Agent, or Firm* — Fitzpatrick, Cella, Harper & Scinto

(57) **CLAIM**

The ornamental design for an ink tank for printer, as shown and described.

DESCRIPTION

FIG. 1 is a front view of an ink tank for printer showing our new design;

FIG. 2 is a rear view thereof;

FIG. 3 is a top plan view thereof;

FIG. 4 is a bottom plan view thereof;

FIG. 5 is a left side view thereof;

FIG. 6 is a right side view thereof; and,

FIG. 7 is a perspective view thereof.

The broken lines are for illustration only and form no part of the claimed design.

1 Claim, 4 Drawing Sheets

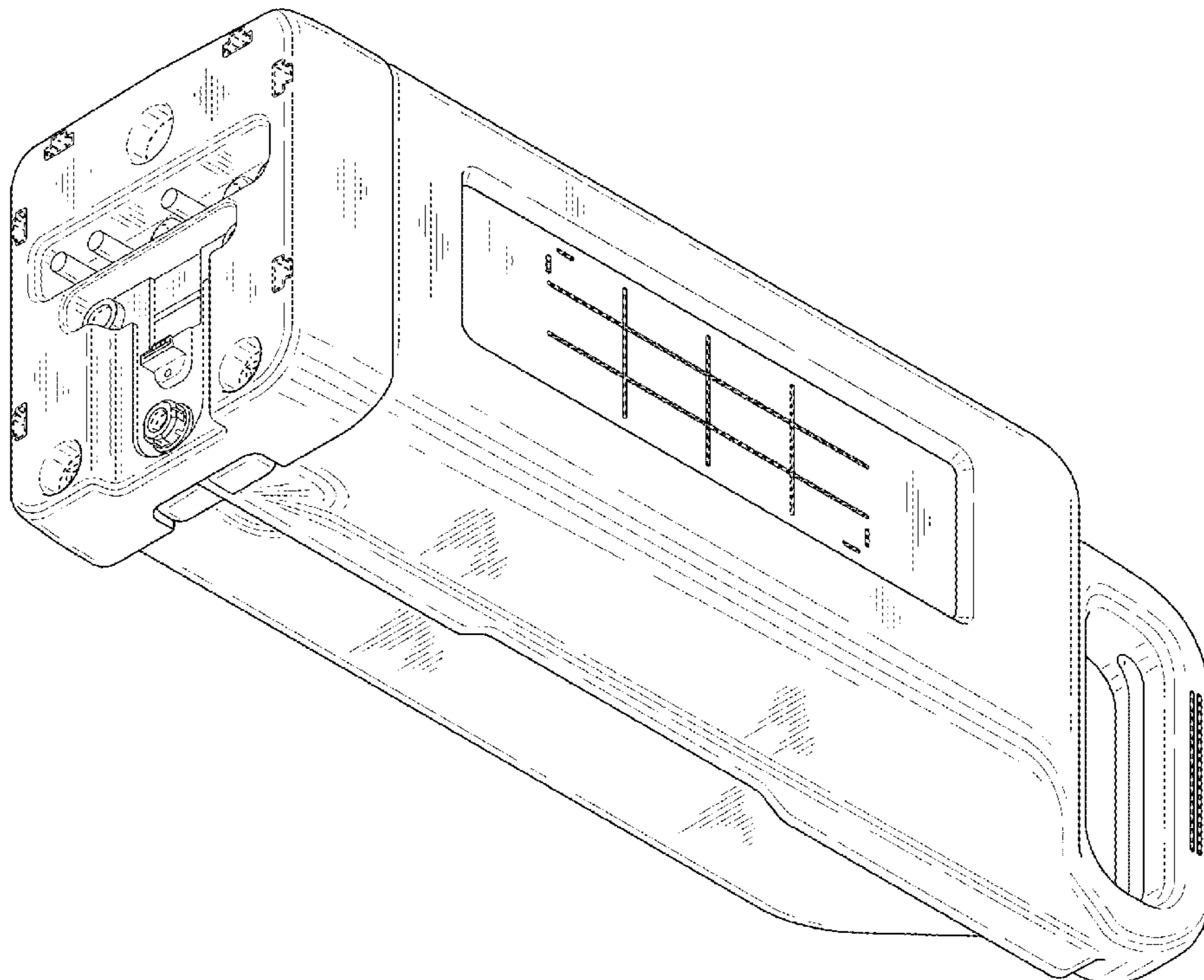

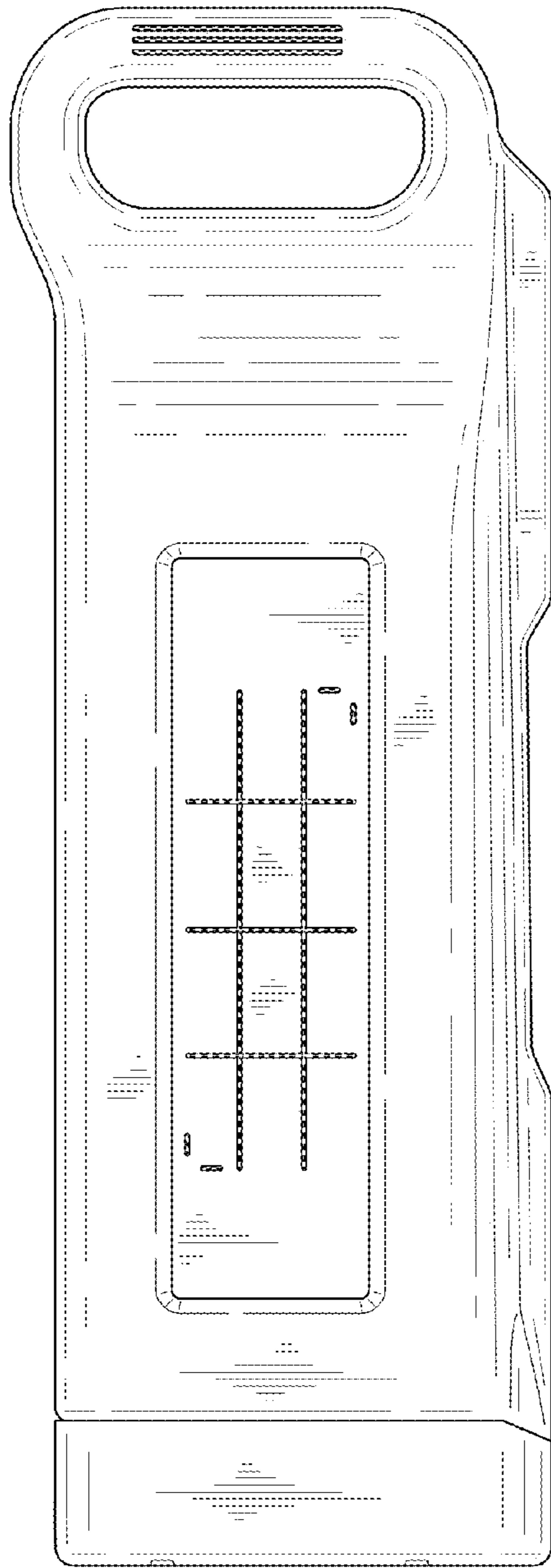

FIG. 1

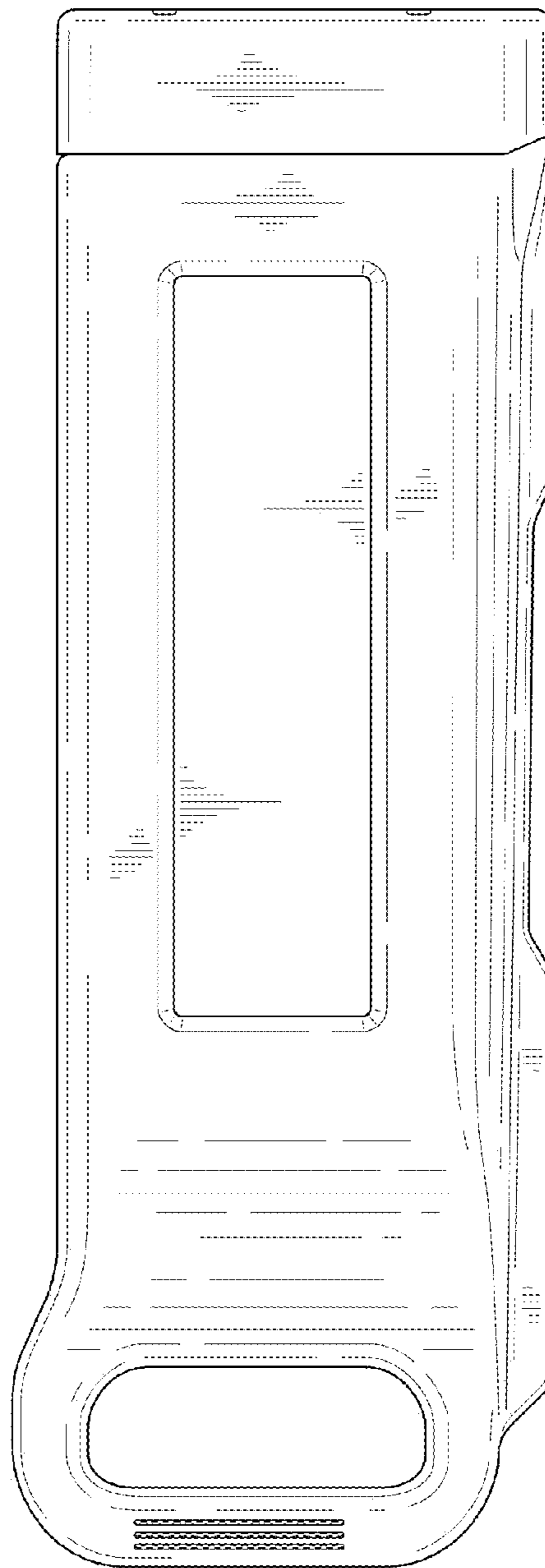

FIG. 2

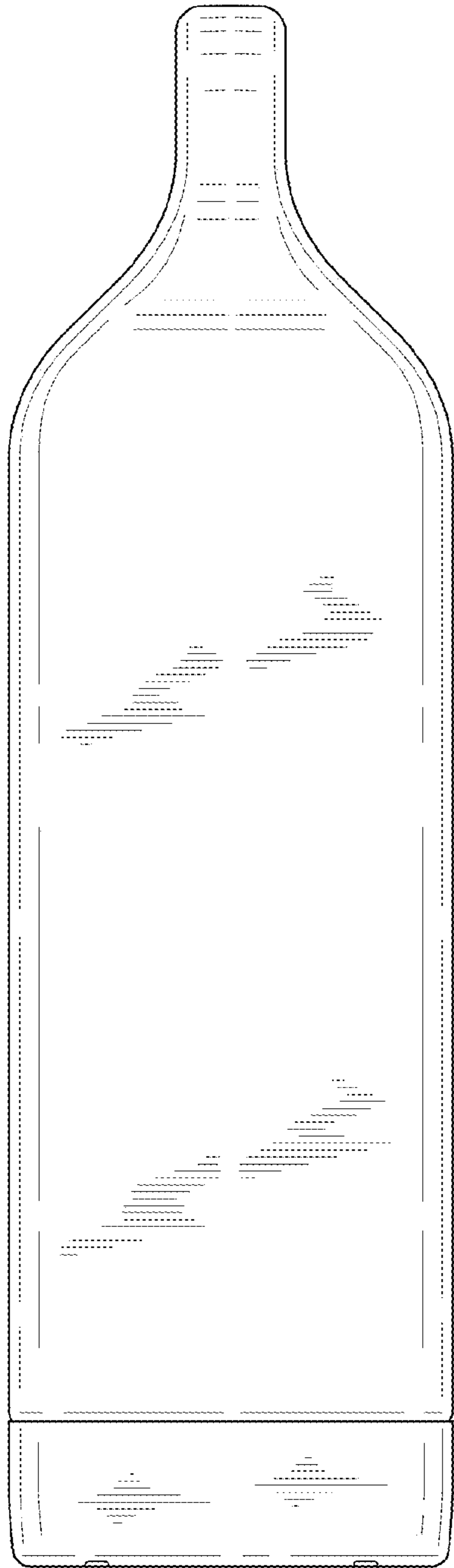

FIG. 3

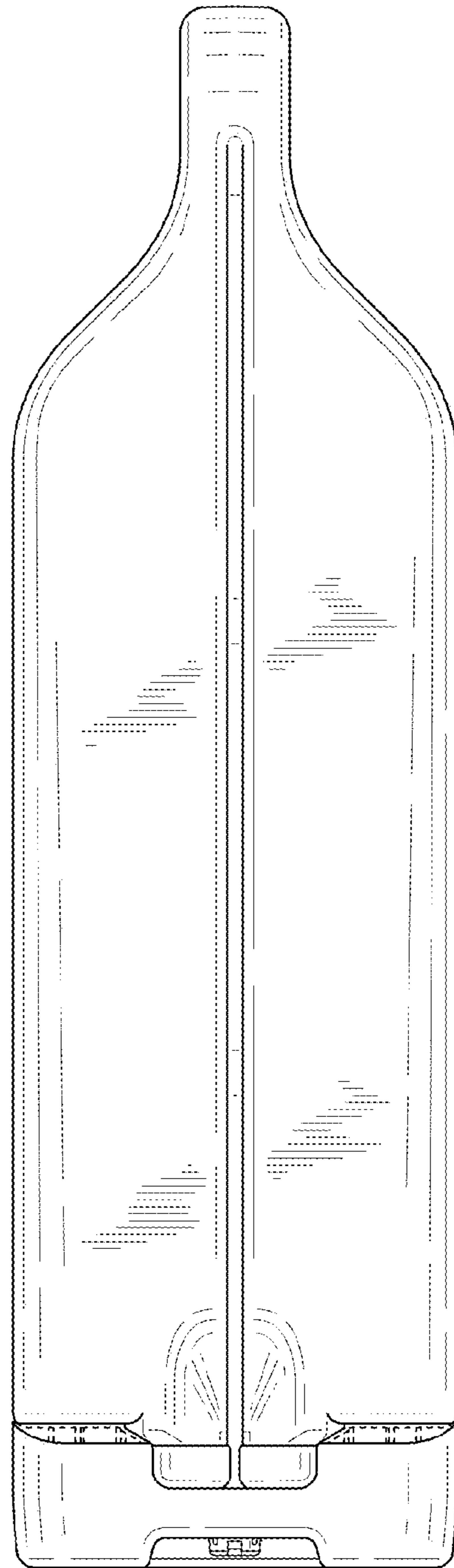

FIG. 4

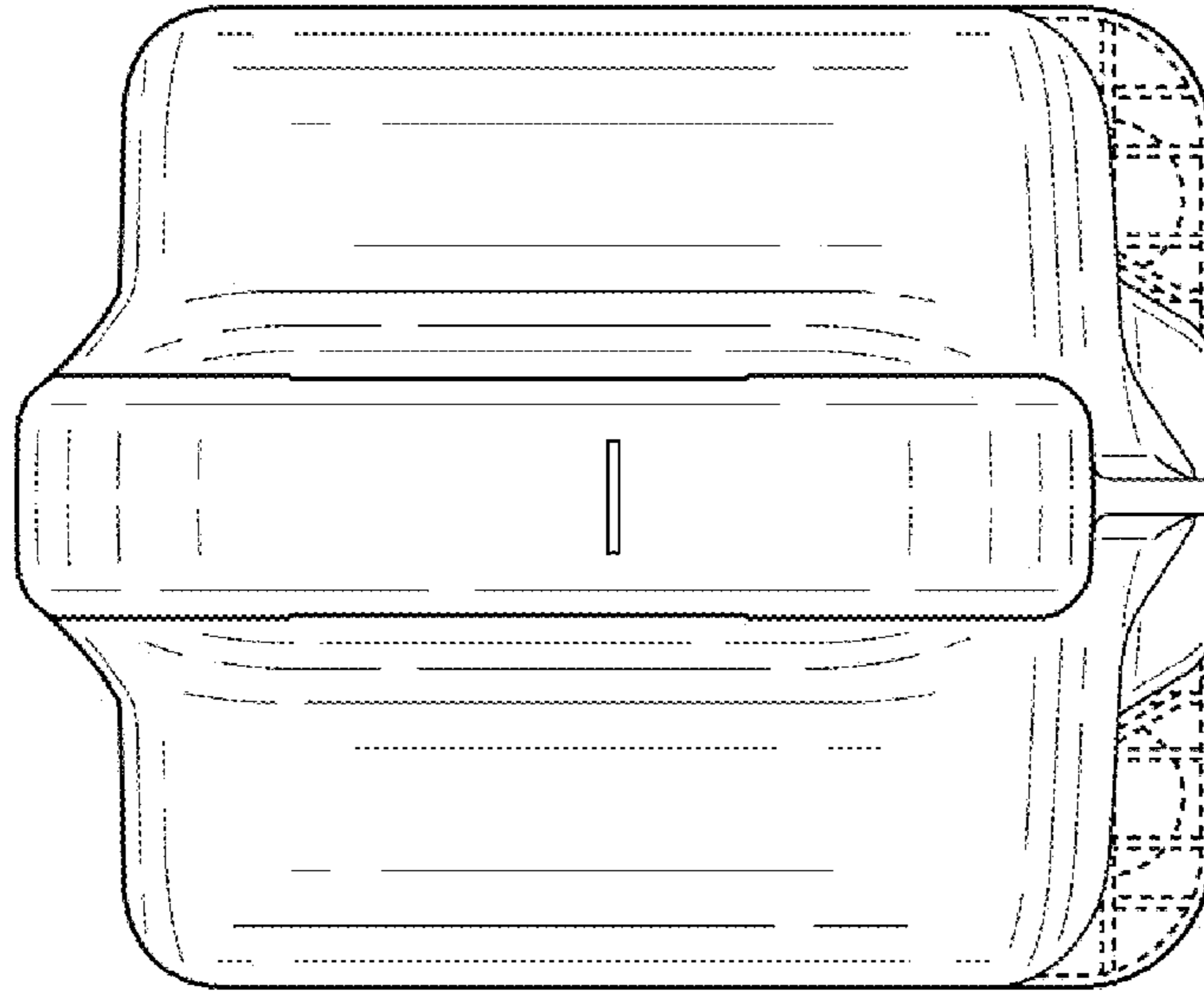

FIG. 6

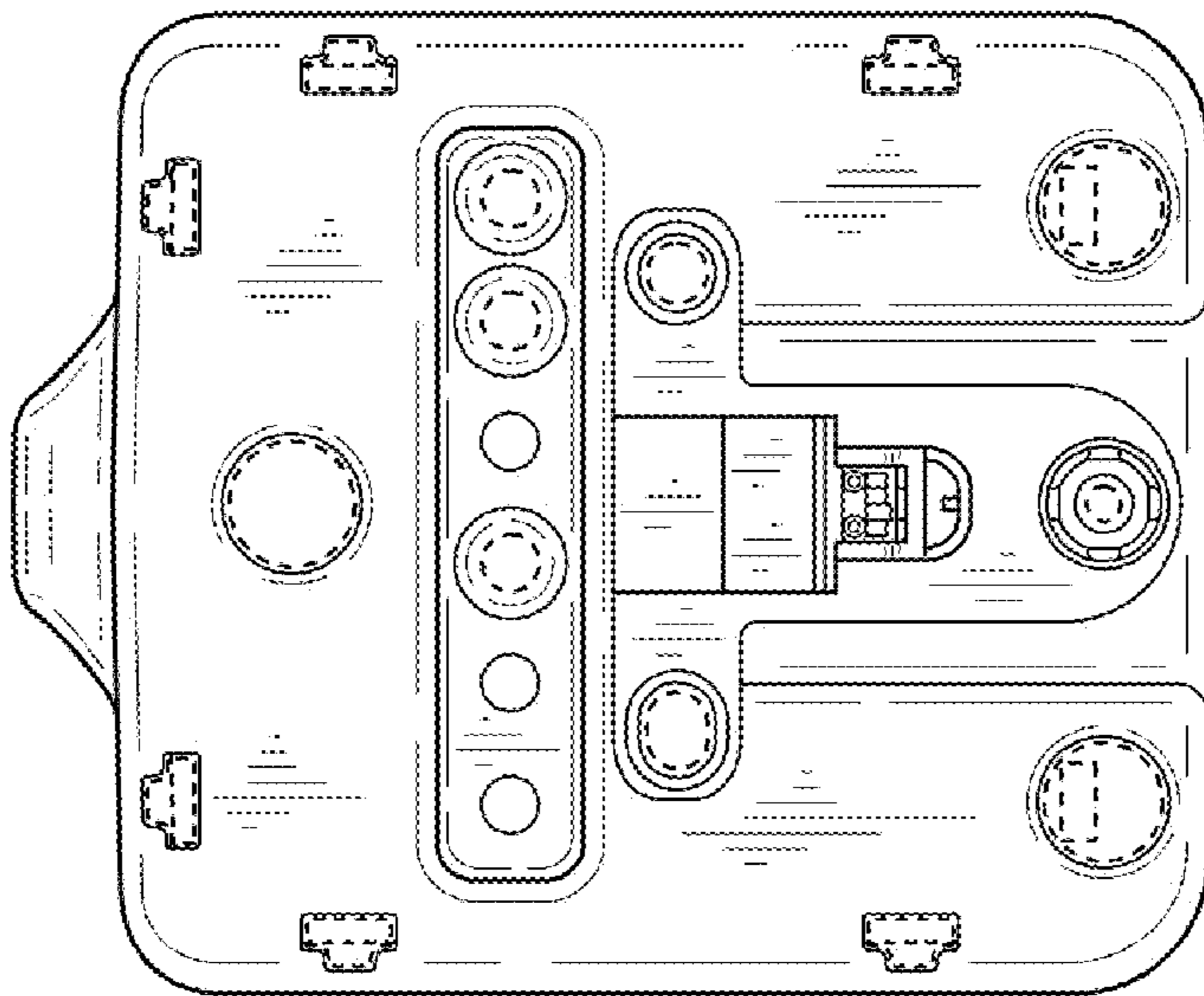

FIG. 5

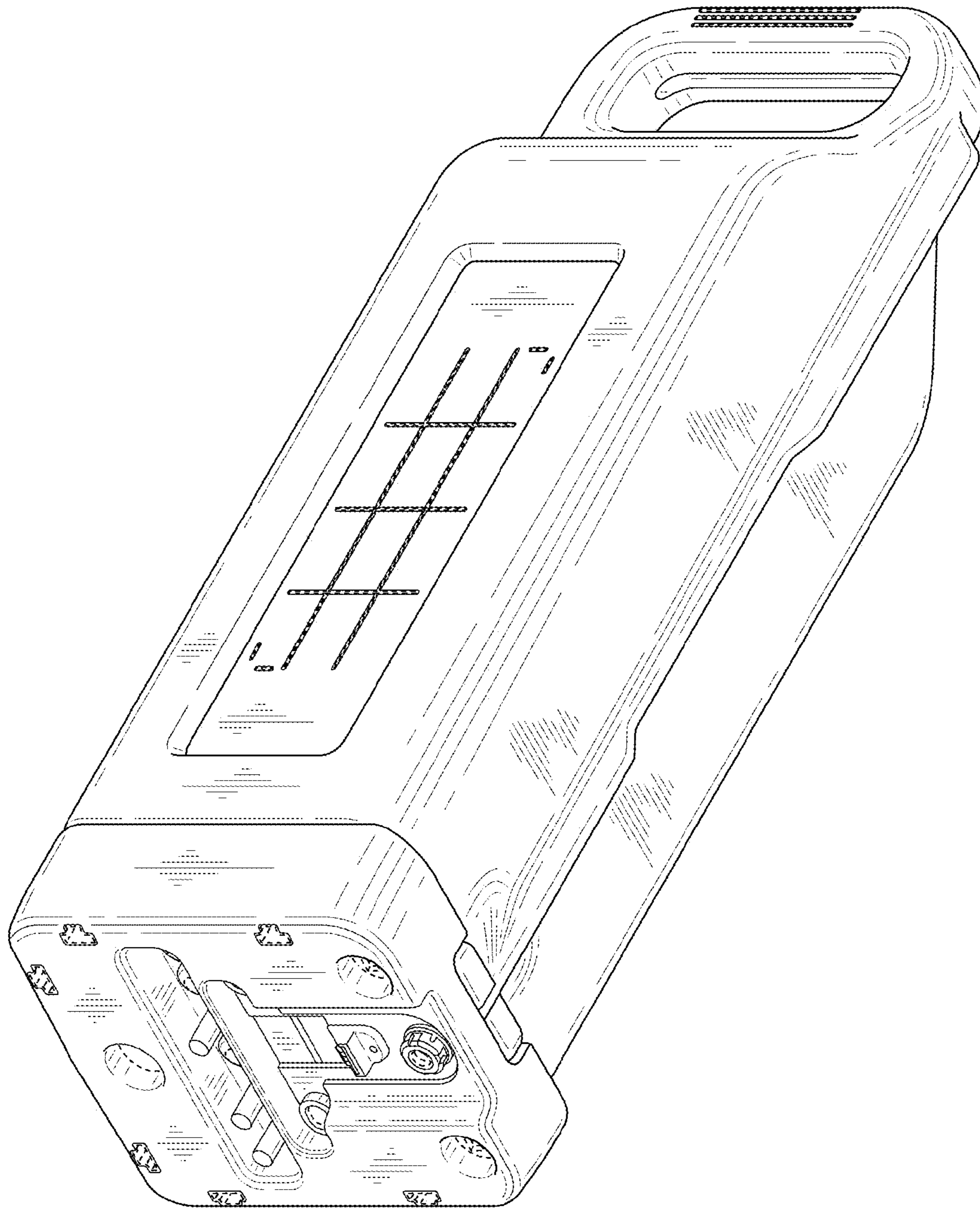

FIG. 7