



US00D674415S

(12) **United States Design Patent**  
**Lee et al.**

(10) **Patent No.:** **US D674,415 S**  
(45) **Date of Patent:** **\*\* Jan. 15, 2013**

(54) **REFRIGERATOR**

(75) Inventors: **Hang Bok Lee**, Gyeonggi-do (KR);  
**Kyung Soo Park**, Seoul (KR); **Seon**  
**Kyu Kim**, Seoul (KR); **Hyok Ku Kwon**,  
Seoul (KR); **Kyu Tae Park**,  
Gyeonggi-do (KR)

(73) Assignee: **LG Electronics Inc.**, Seoul (KR)

(\*\*) Term: **14 Years**

(21) Appl. No.: **29/411,325**

(22) Filed: **Jan. 19, 2012**

(30) **Foreign Application Priority Data**

Aug. 2, 2011 (KR) ..... 30-2011-0032330

(51) **LOC (9) Cl.** ..... **15-07**

(52) **U.S. Cl.** ..... **D15/86**

(58) **Field of Classification Search** ..... D15/79-90;  
62/3.6, 3.63, 3.64, 293, 331, 371, 440-445,  
62/467; 312/112-119, 236, 440-408, 138.1,  
312/139.1

See application file for complete search history.

(56) **References Cited**

U.S. PATENT DOCUMENTS

D190,453 S *	5/1961	Munz et al. ....	D15/86
D541,828 S *	5/2007	Nishibori et al. ....	D15/87
D615,564 S *	5/2010	Kristiansen et al. ....	D15/86
D629,021 S *	12/2010	Cho et al. ....	D15/85
D655,321 S *	3/2012	Lee et al. ....	D15/86
D658,215 S *	4/2012	Seo et al. ....	D15/86

\* cited by examiner

*Primary Examiner* — Mitchell Siegel

(74) *Attorney, Agent, or Firm* — Morgan, Lewis & Bockius LLP

(57) **CLAIM**

We claim the ornamental design for a refrigerator, as shown and described.

**DESCRIPTION**

FIG. 1 is a perspective view of a refrigerator showing our new design:

FIG. 2 is a front elevation view thereof;

FIG. 3 is a rear elevation view thereof;

FIG. 4 is a left-side elevation view thereof;

FIG. 5 is a right-side elevation view thereof;

FIG. 6 is a top plan view thereof; and,

FIG. 7 is a bottom plan view thereof.

**1 Claim, 6 Drawing Sheets**

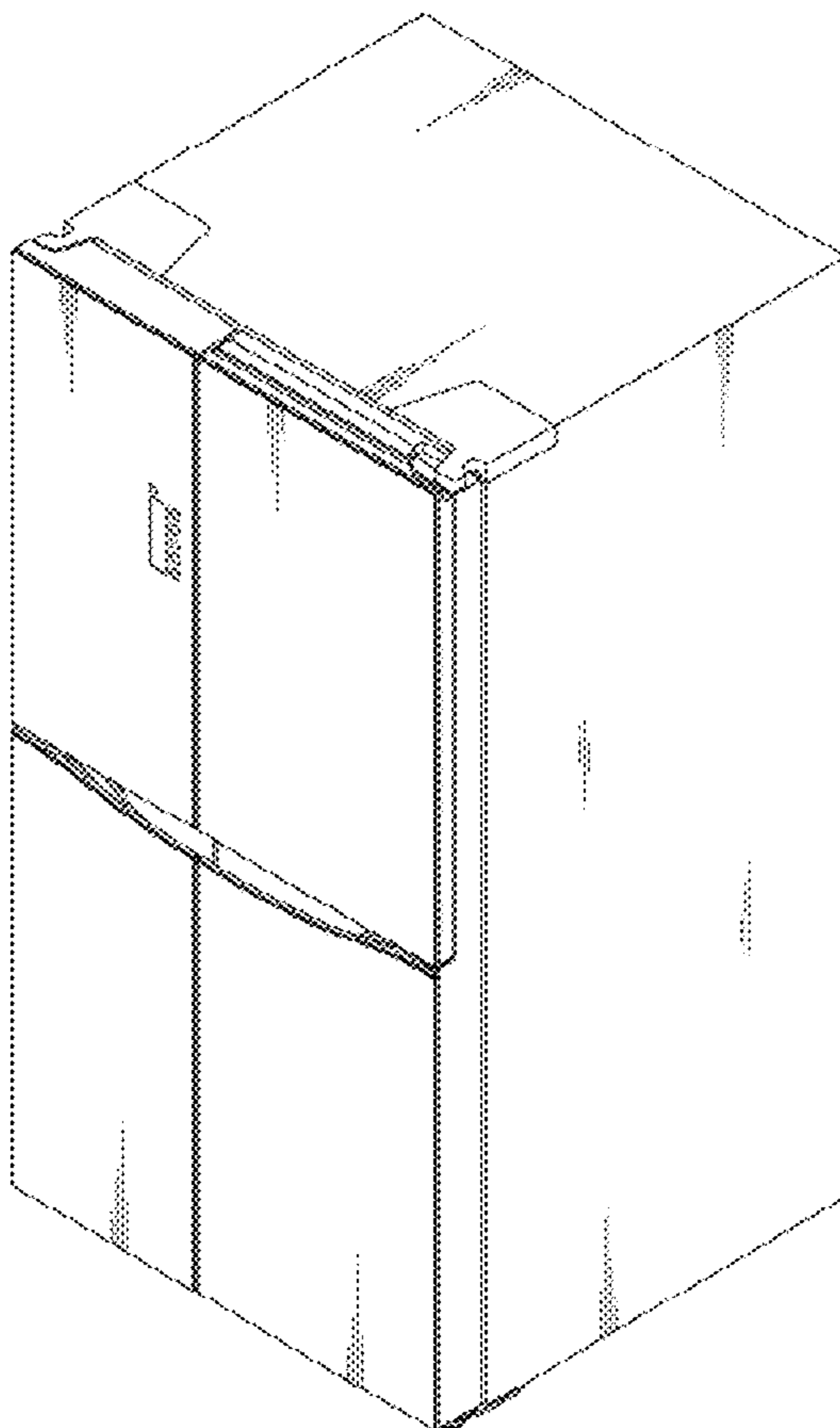

FIG. 1

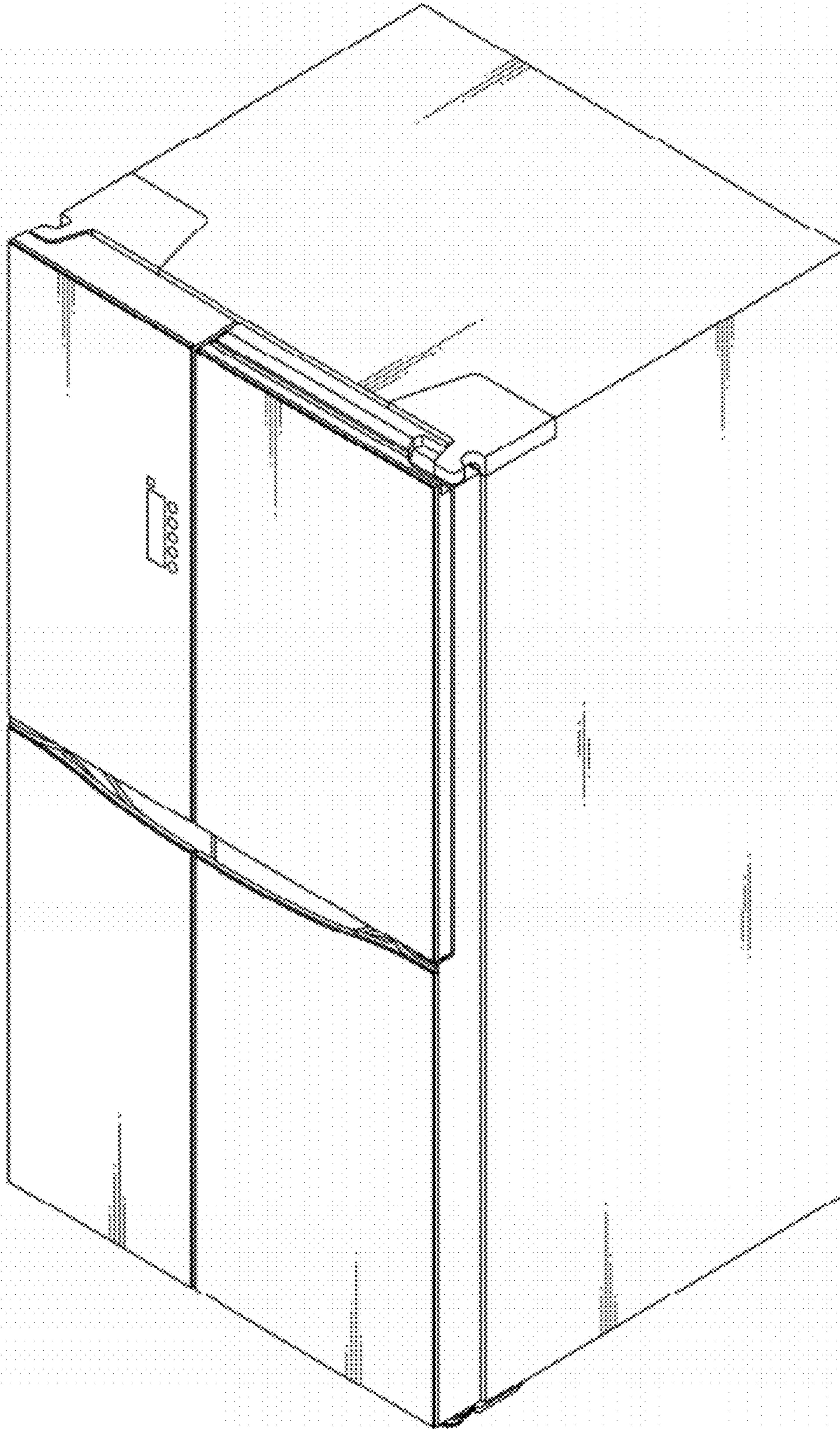

FIG. 2

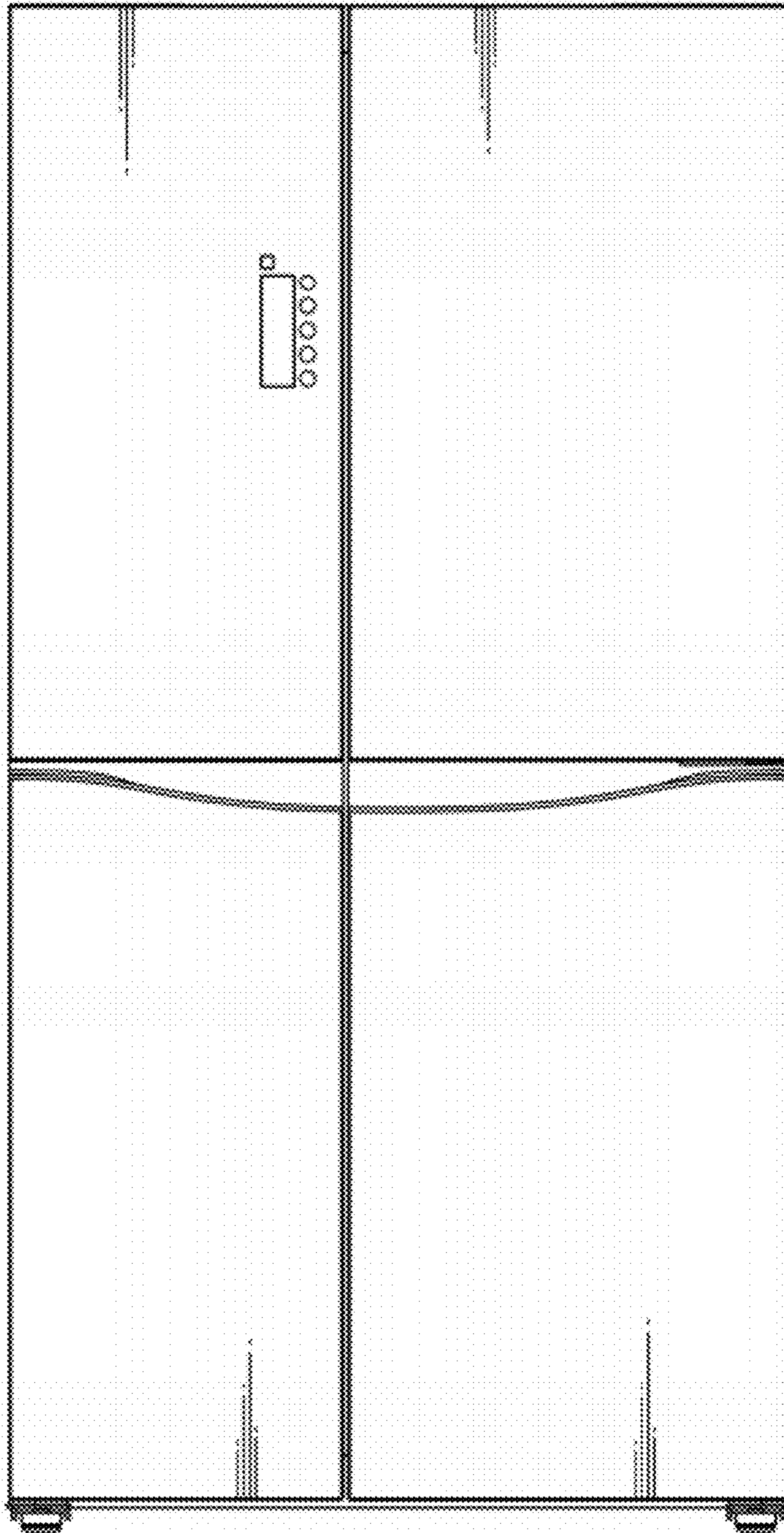

FIG. 3

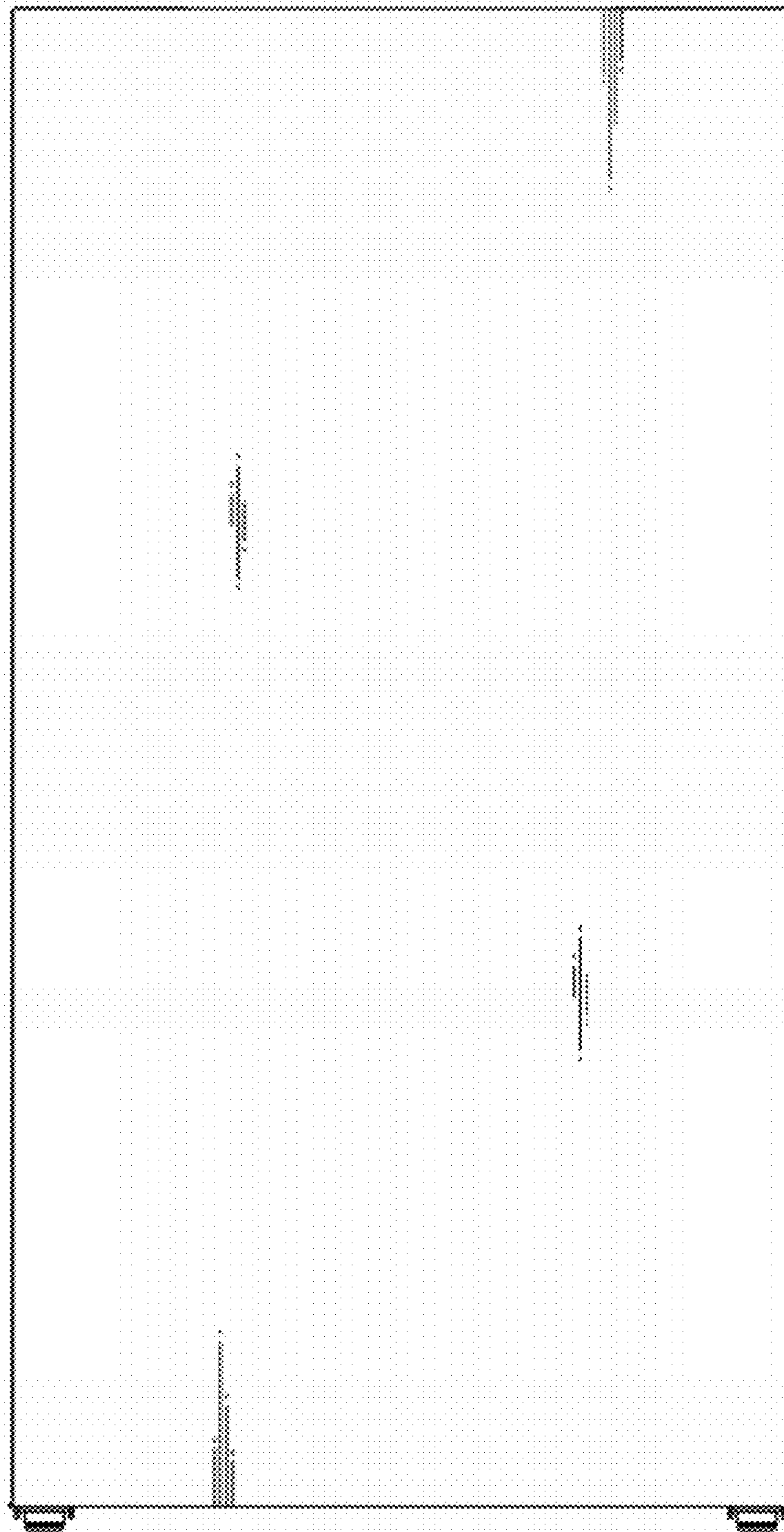

FIG. 4

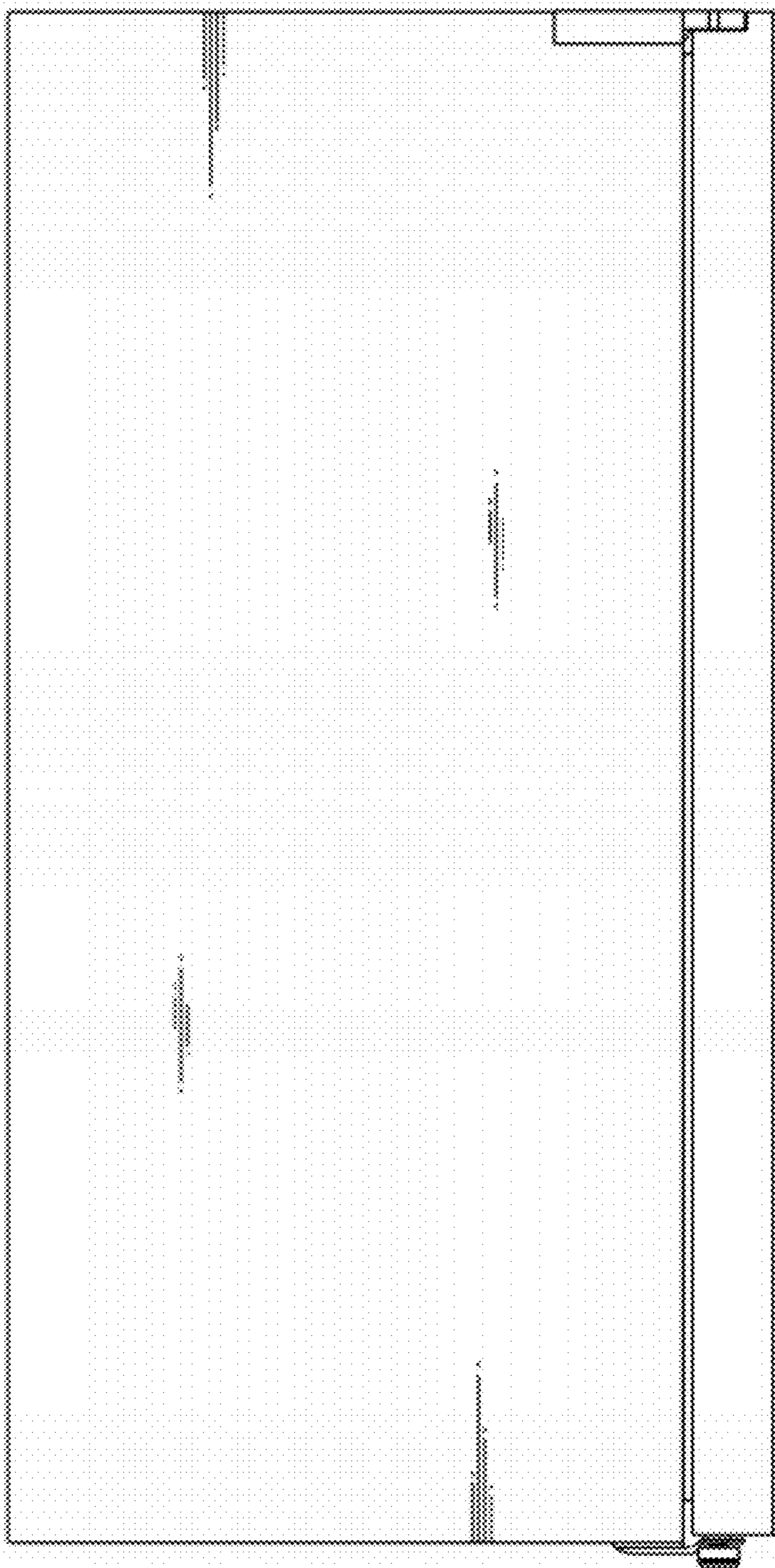

FIG. 5

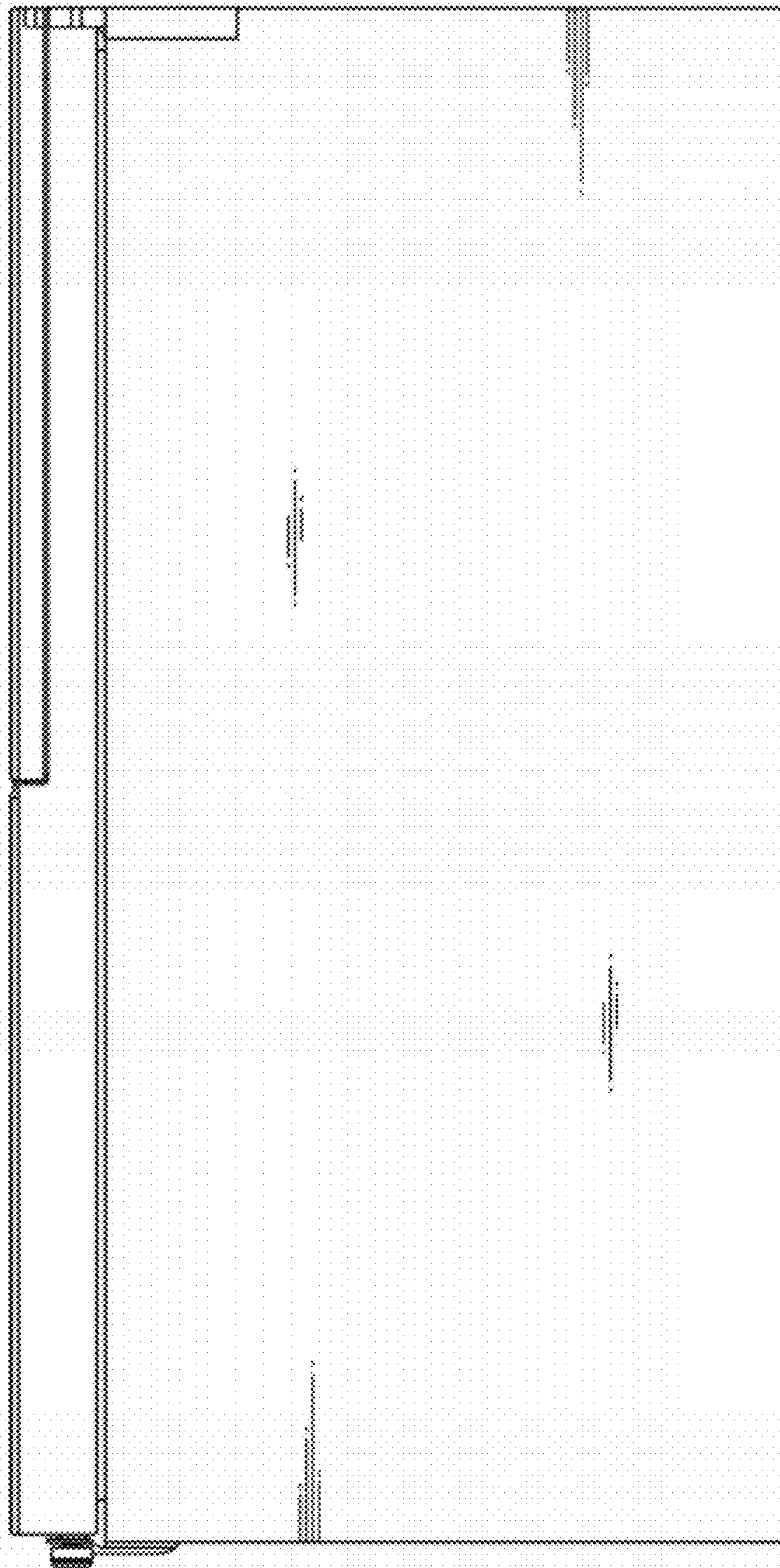

FIG. 6

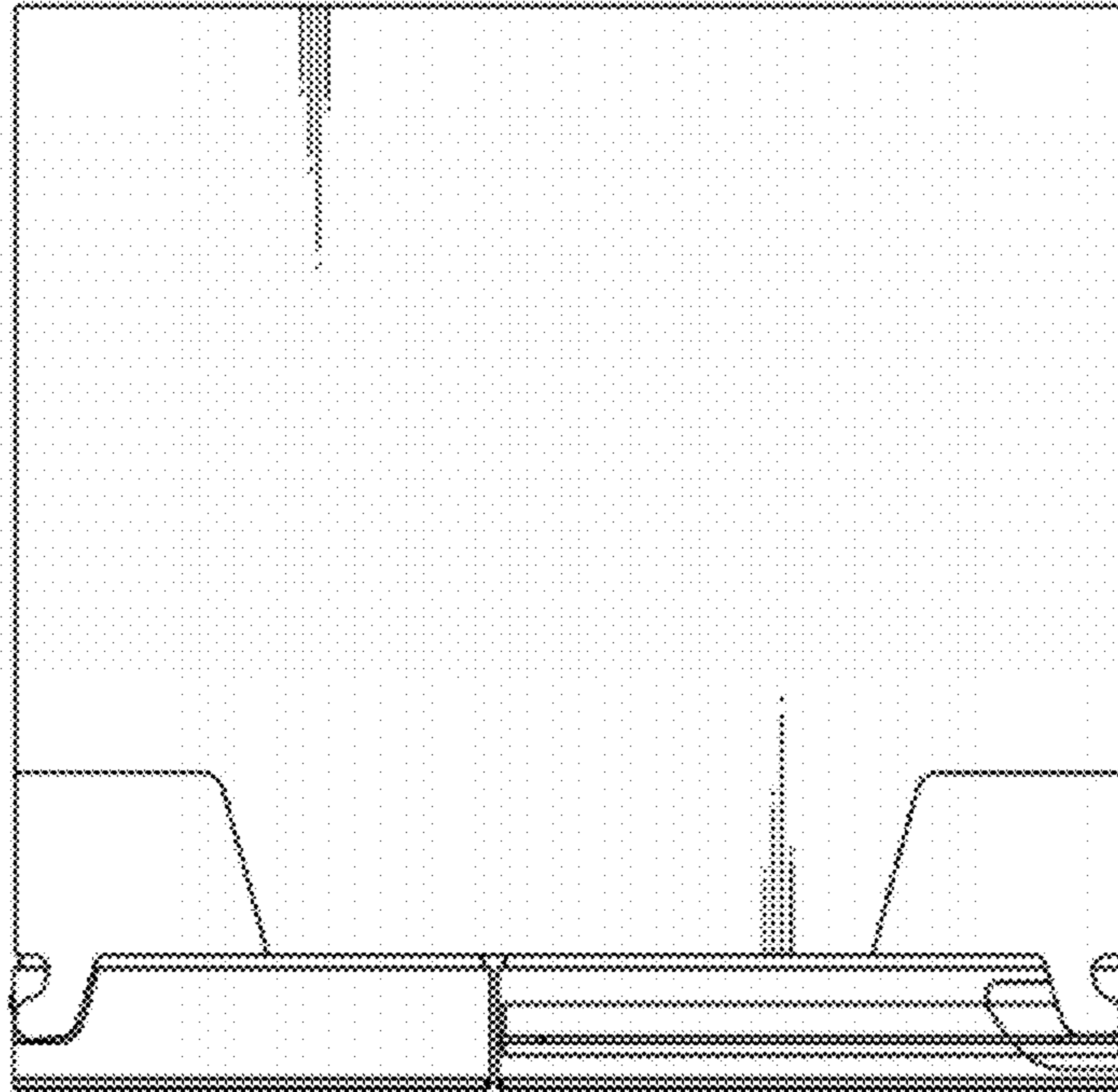

FIG. 7

