



US00D674270S

(12) **United States Design Patent**
Gerber

(10) **Patent No.:** **US D674,270 S**
(45) **Date of Patent:** **** Jan. 15, 2013**

(54) **ROPE HOLDERS**

(76) Inventor: **Martin Gerber**, Marina del Ray, CA
(US)

(**) Term: **14 Years**

(21) Appl. No.: **29/369,264**

(22) Filed: **Sep. 3, 2010**

(51) **LOC (9) Cl.** **08-05**

(52) **U.S. Cl.** **D8/356**

(58) **Field of Classification Search** D6/580,
D6/513; D8/356, 394, 382, 349, 354, 373;
174/68.3; 24/115 F; 411/431; 256/19; D13/133
See application file for complete search history.

(56) **References Cited**

U.S. PATENT DOCUMENTS

1,625,585 A * 4/1927 Archer 242/599.2
(Continued)

Primary Examiner — Cynthia Underwood

(74) *Attorney, Agent, or Firm* — Muncy, Geissler, Olds &
Lowe, PLLC

(57) **CLAIM**

The ornamental design of a rope holder, as shown and
described.

DESCRIPTION

FIG. 1 is a rear perspective view of a rope holder according to
the invention.

FIG. 2 is a front perspective view of the rope holder of FIG. 1.

FIG. 3 is a left plan view of the rope holder of FIG. 1.

FIG. 4 is a front plan view of the rope holder of FIG. 1.

FIG. 5 is a right plan view of the rope holder of FIG. 1.

FIG. 6 is a top plan view of the rope holder of FIG. 1.

FIG. 7 is a rear plan view of the rope holder of FIG. 1.

FIG. 8 is a bottom plan view of the rope holder of FIG. 1.

FIG. 9 is a front perspective view of an upper portion of the
rope holder of FIG. 1, shown separated for ease of illustration.

FIG. 10 is a left plan view of the upper portion of the rope
holder of FIG. 9, shown separated for ease of illustration.

FIG. 11 is a front plan view of the upper portion of the rope
holder of FIG. 9, shown separated for ease of illustration.

FIG. 12 is a right plan view of the upper portion of the rope
holder of FIG. 9, shown separated for ease of illustration.

FIG. 13 is a top plan view of the upper portion of the rope
holder of FIG. 9, shown separated for ease of illustration.

FIG. 14 is a rear plan view of the upper portion of the rope
holder of FIG. 9, shown separated for ease of illustration.

FIG. 15 is a front perspective view of a lower portion of the
rope holder of FIG. 1, shown separated for ease of illustration.

FIG. 16 is a left plan view of the lower portion of the rope
holder of FIG. 15, shown separated for ease of illustration.

FIG. 17 is a front plan view of the lower portion of the rope
holder of FIG. 15, shown separated for ease of illustration.

FIG. 18 is a right plan view of the lower portion of the rope
holder of FIG. 15, shown separated for ease of illustration.

FIG. 19 is a bottom plan view of the lower portion of the rope
holder of FIG. 15, shown separated for ease of illustration;

and,

FIG. 20 is a rear plan view of the lower portion of the rope
holder of FIG. 15, shown separated for ease of illustration.

Exhibits A1-7 shows the shaded portions of FIGS. 2-8,
respectively.

Exhibits B1-7 shows the shaded portions of FIGS. 22-28,
respectively.

Exhibits C1-7 shows the shaded portions of FIGS. 42-48,
respectively.

No claim is being made to the interior portion of the rope
holder.

1 Claim, 20 Drawing Sheets

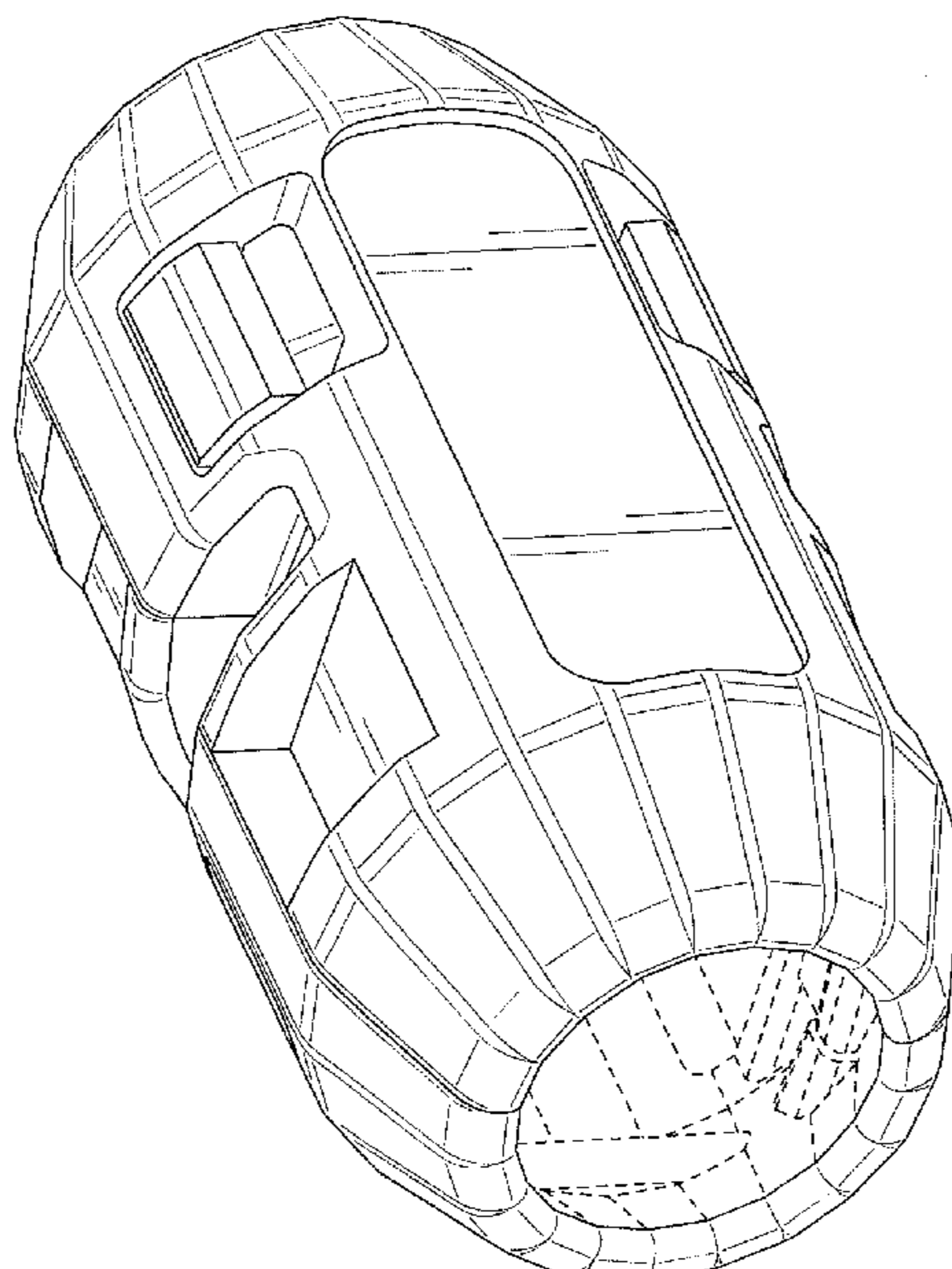

US D674,270 S

Page 2

U.S. PATENT DOCUMENTS

3,132,822	A *	5/1964	Arthur	242/613.4	7,189,100	B1 *	3/2007	Colbourne	439/369
D318,788	S *	8/1991	Crowe	D8/360.1	D644,916	S *	9/2011	Lee	D8/356
5,139,429	A *	8/1992	Herman et al.	439/133	D644,917	S *	9/2011	Lee	D8/356
D363,427	S *	10/1995	Crowe	D8/360.1	D651,504	S *	1/2012	McPhail	D8/356
D447,930	S *	9/2001	Larson	D8/354	D653,100	S *	1/2012	Chen	D8/356
D508,199	S *	8/2005	Winig et al.	D8/356	D655,598	S *	3/2012	Hsu	D8/356
D537,709	S *	3/2007	Thorner	D8/396						

* cited by examiner

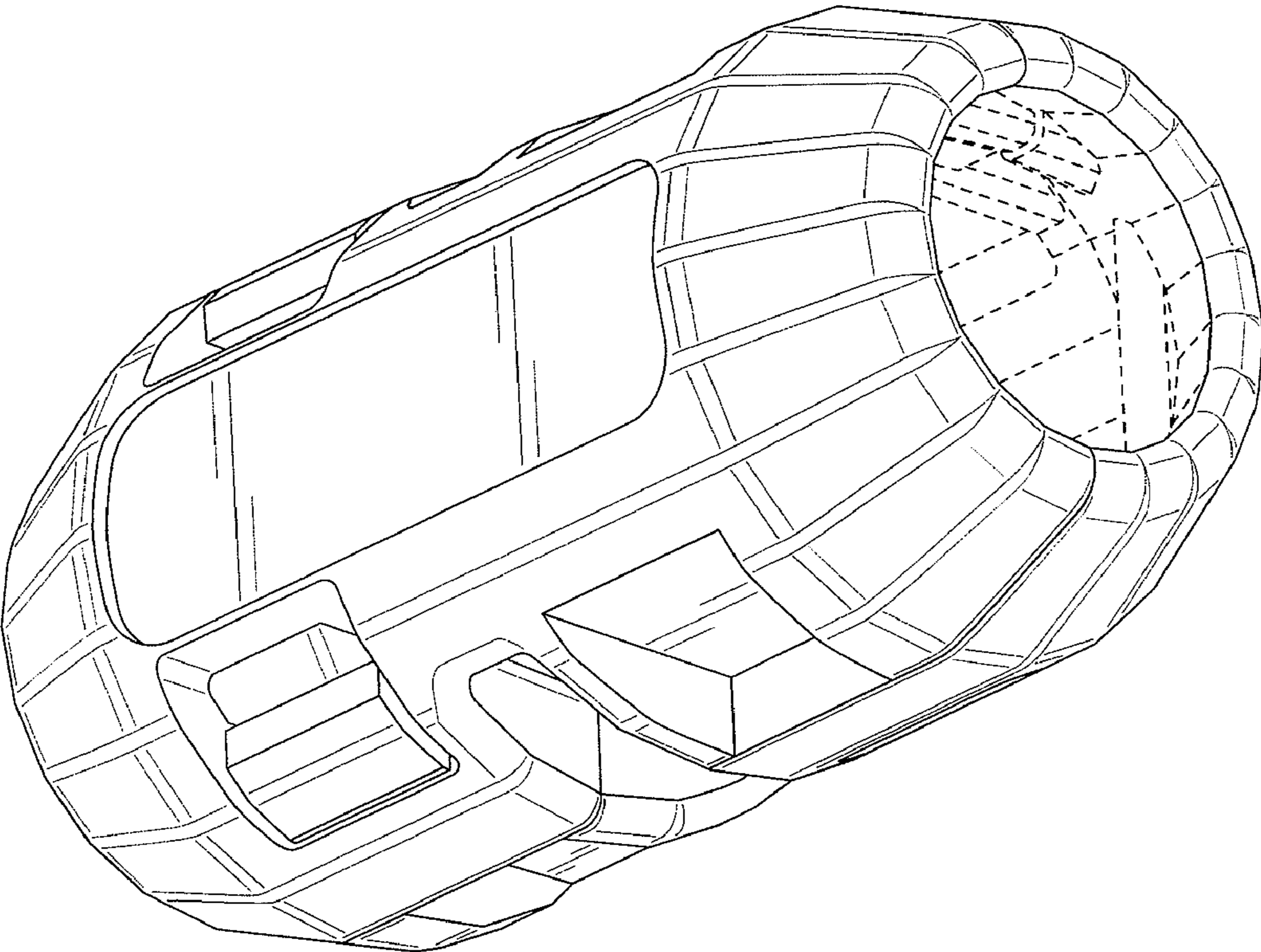

FIG. 1

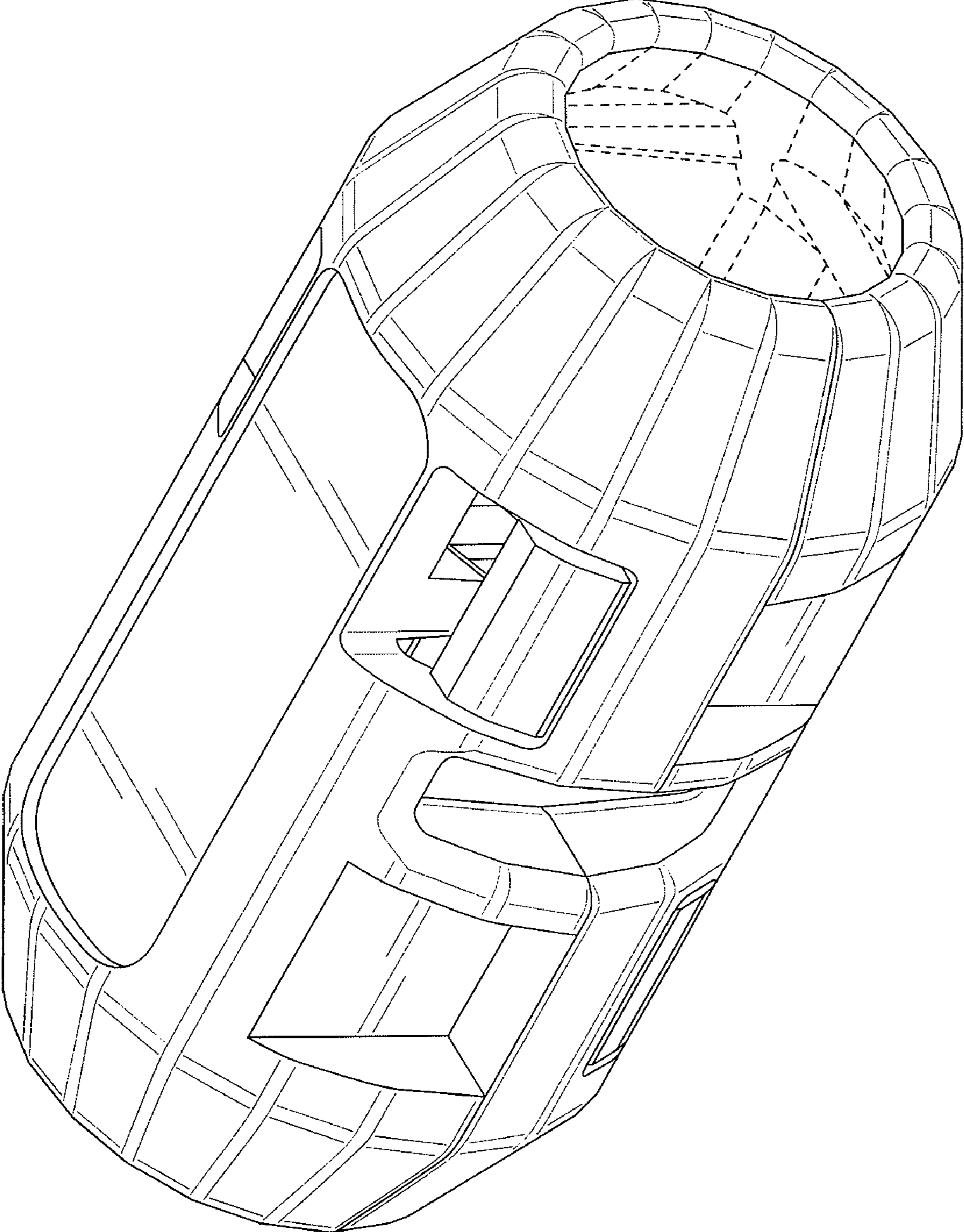

FIG. 2

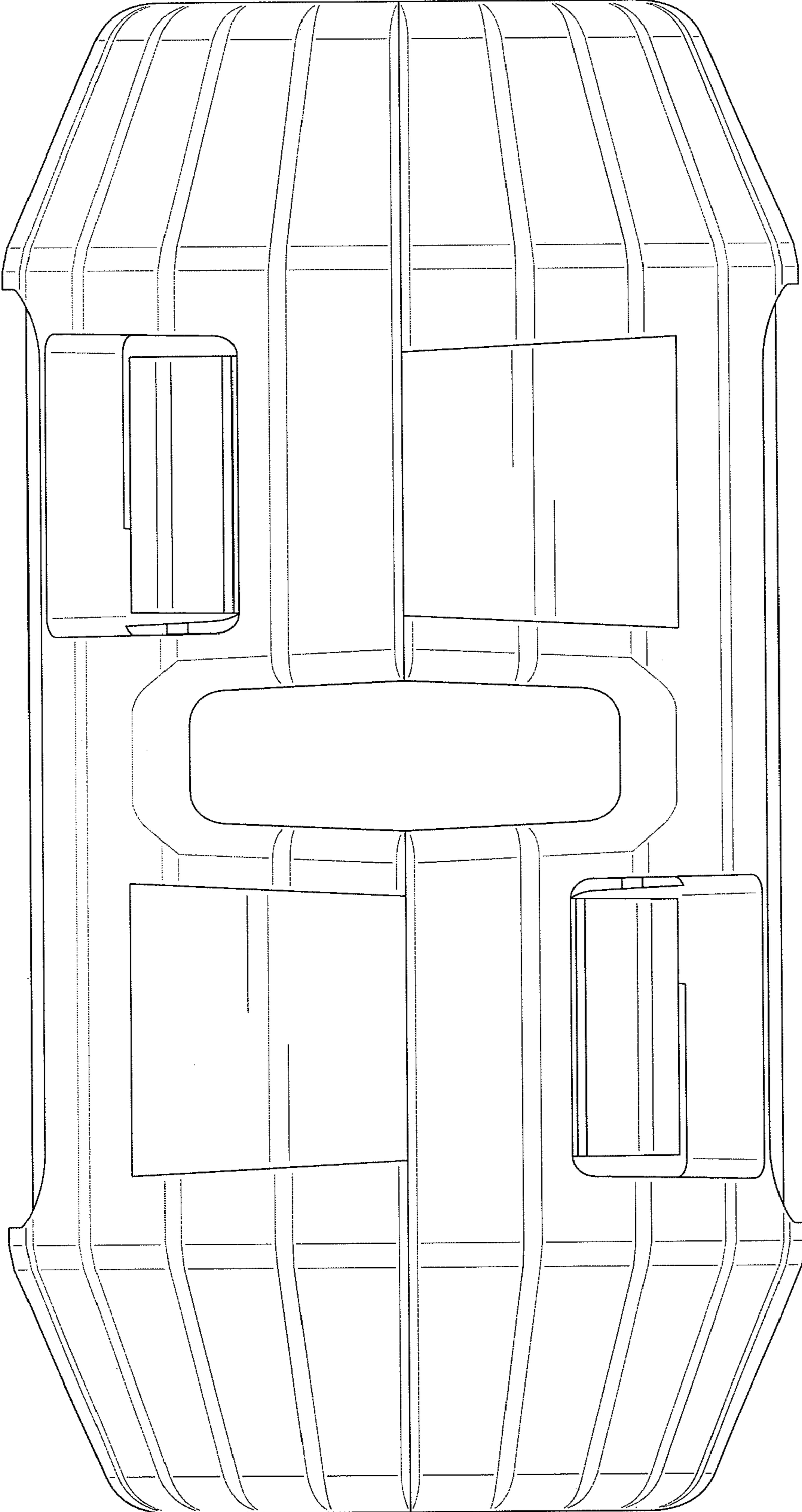

FIG. 3

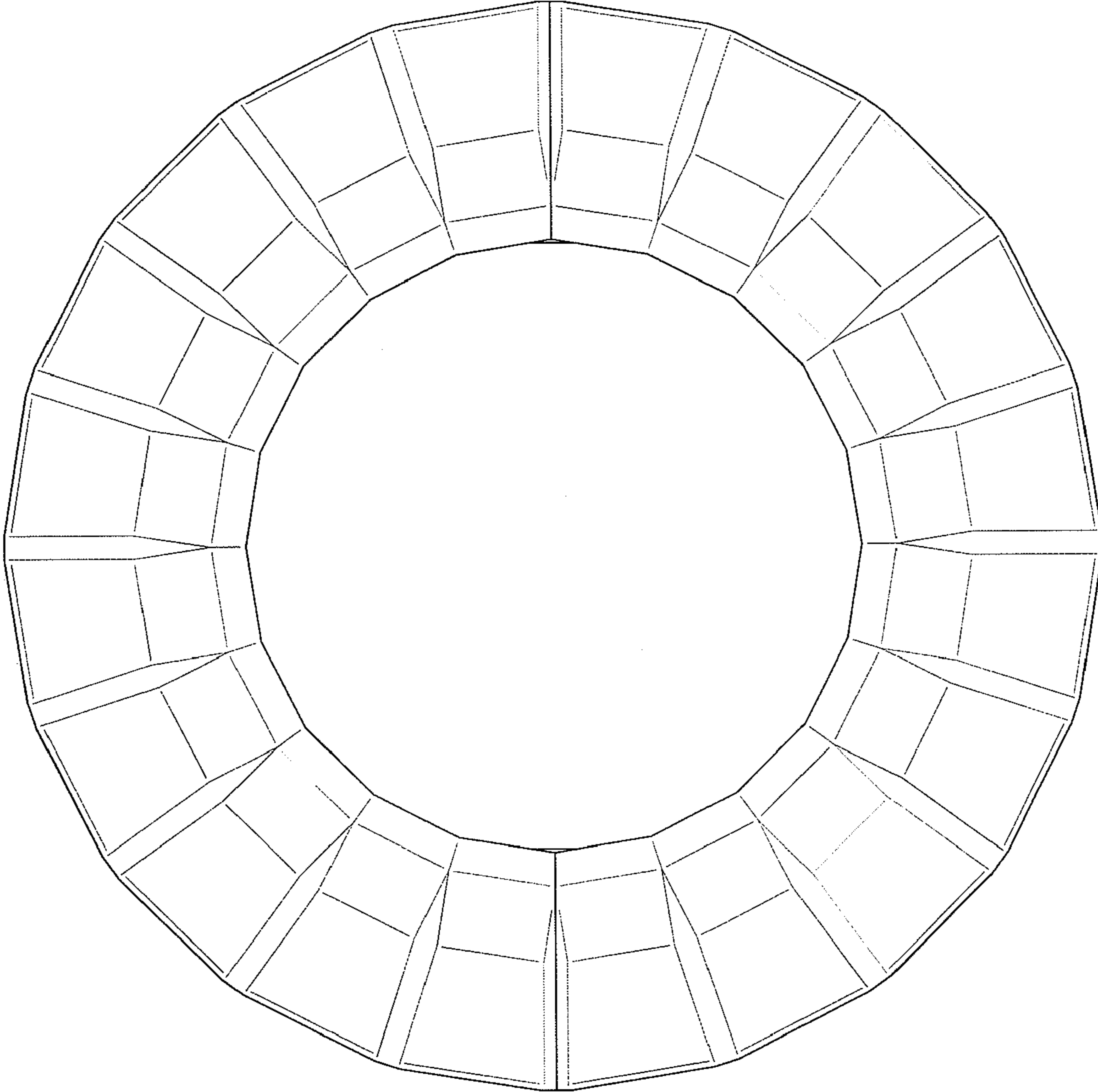

FIG. 4

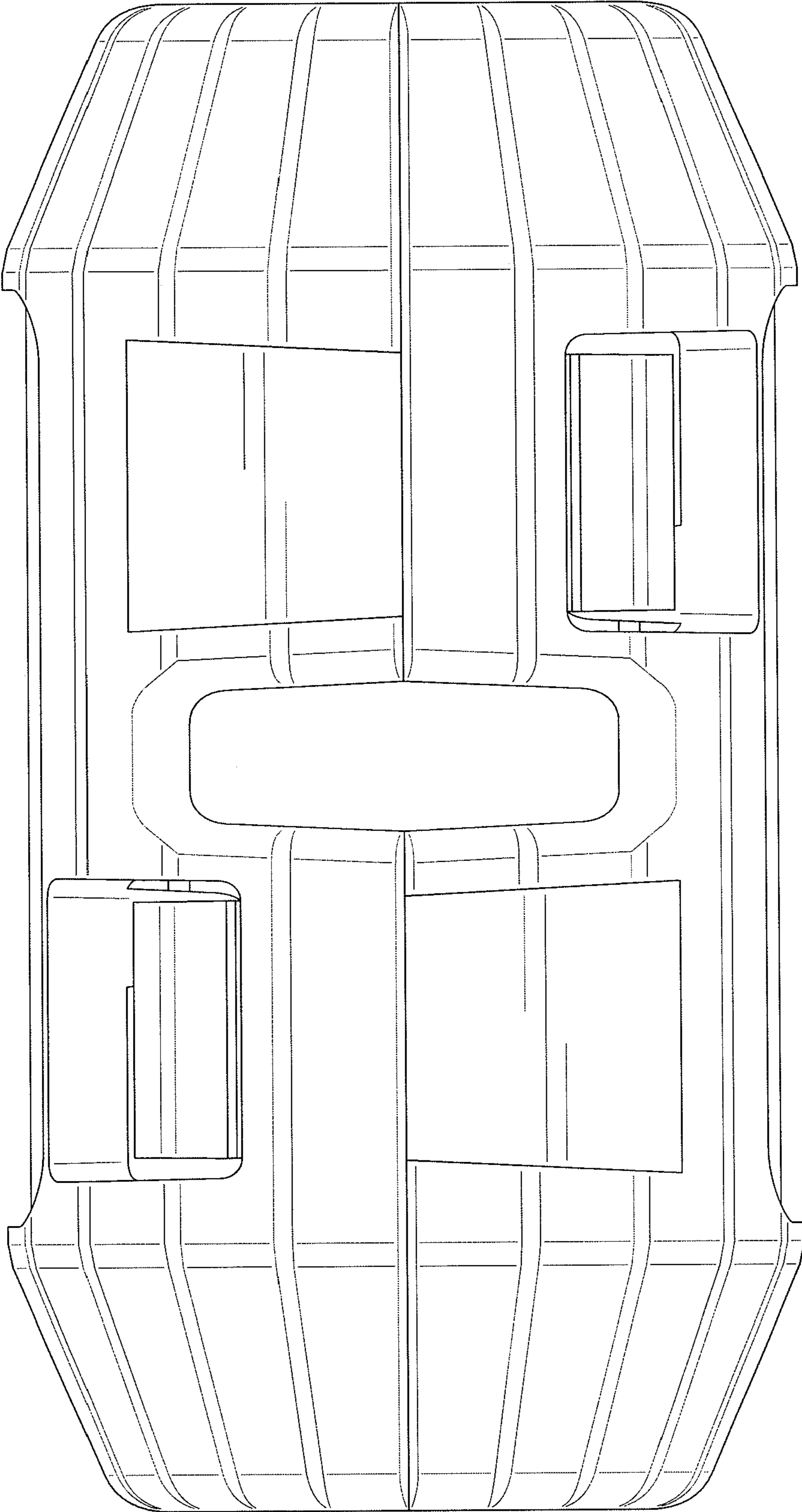

FIG. 5

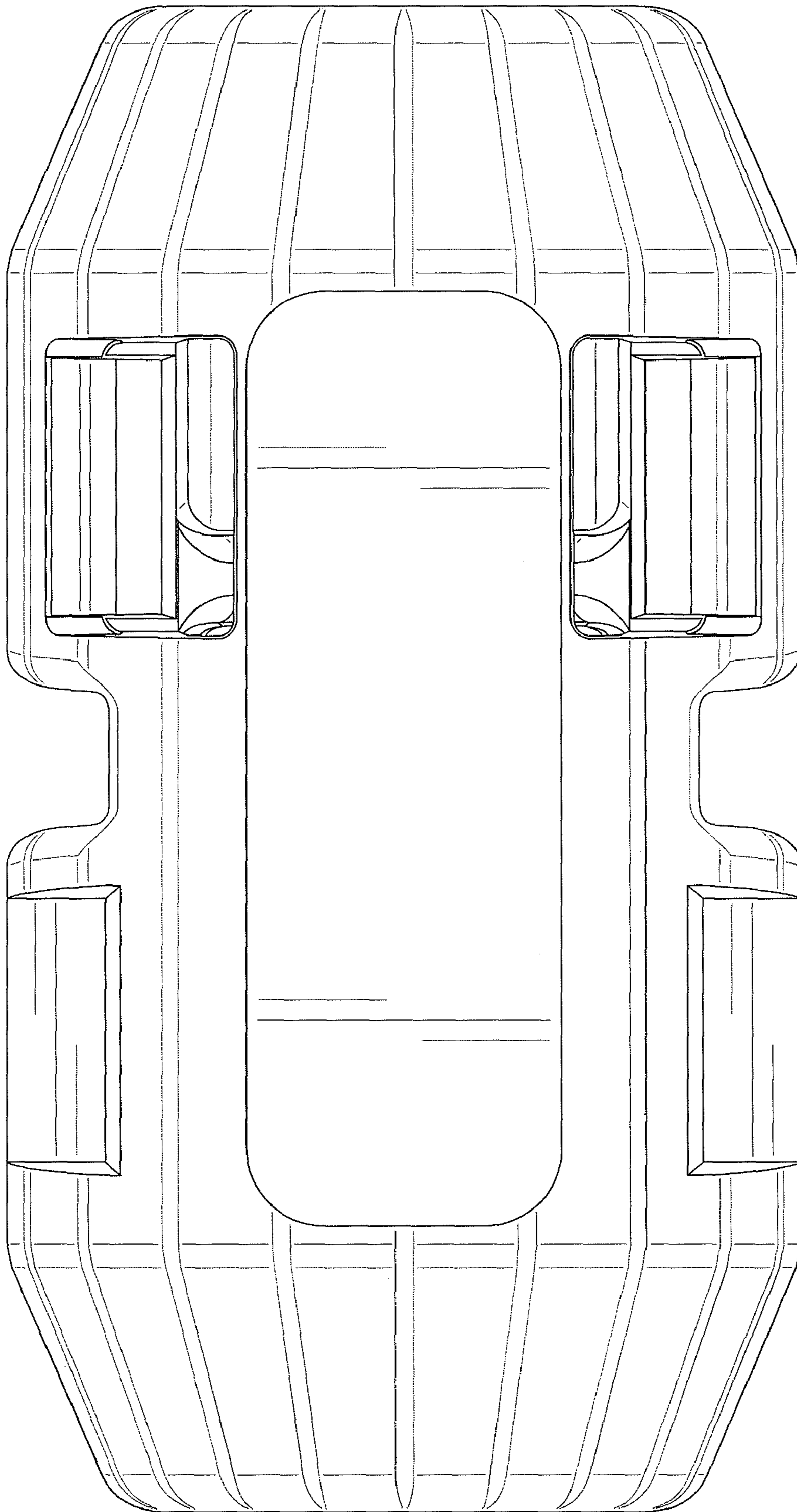

FIG. 6

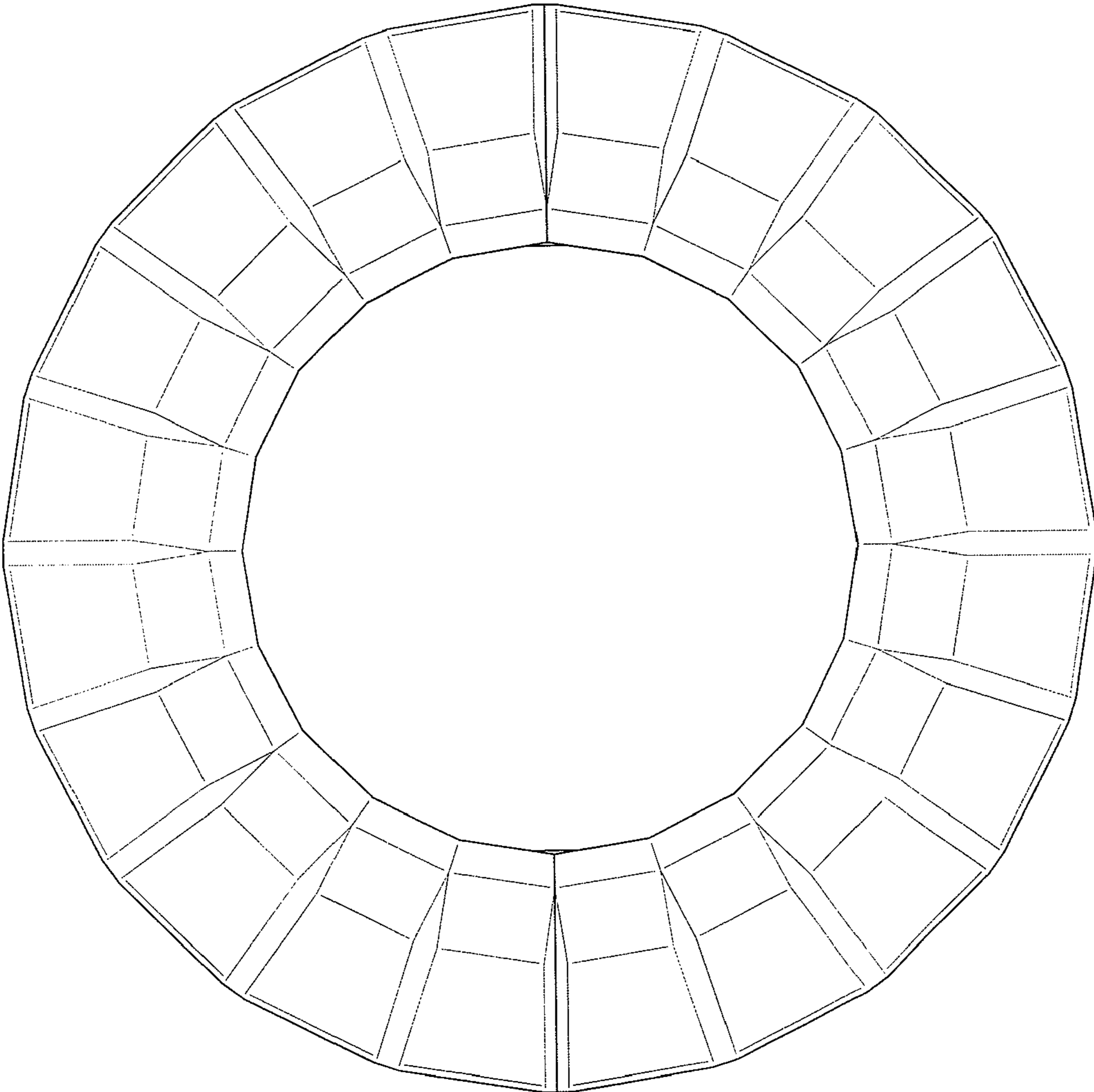

FIG. 7

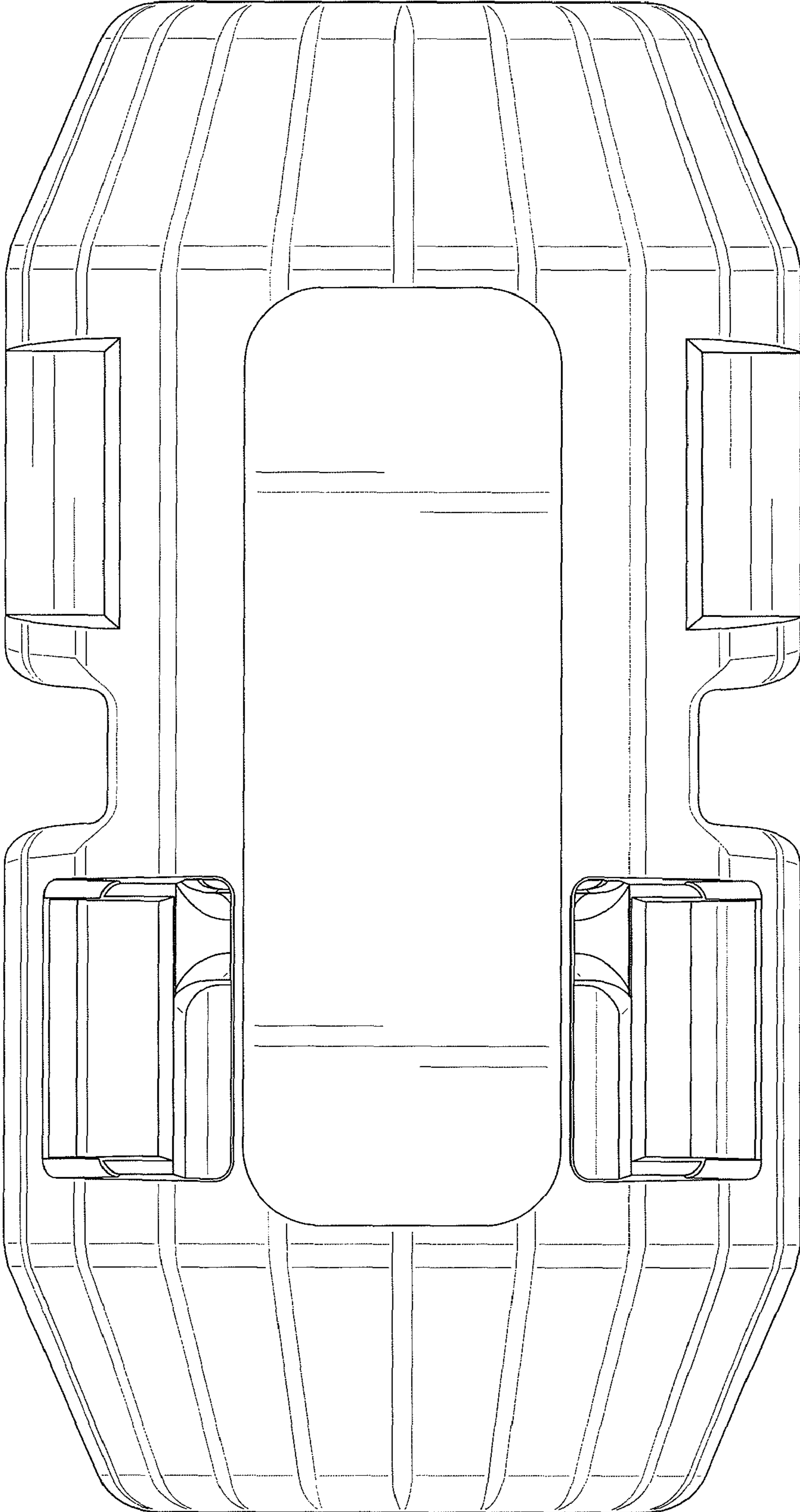

FIG. 8

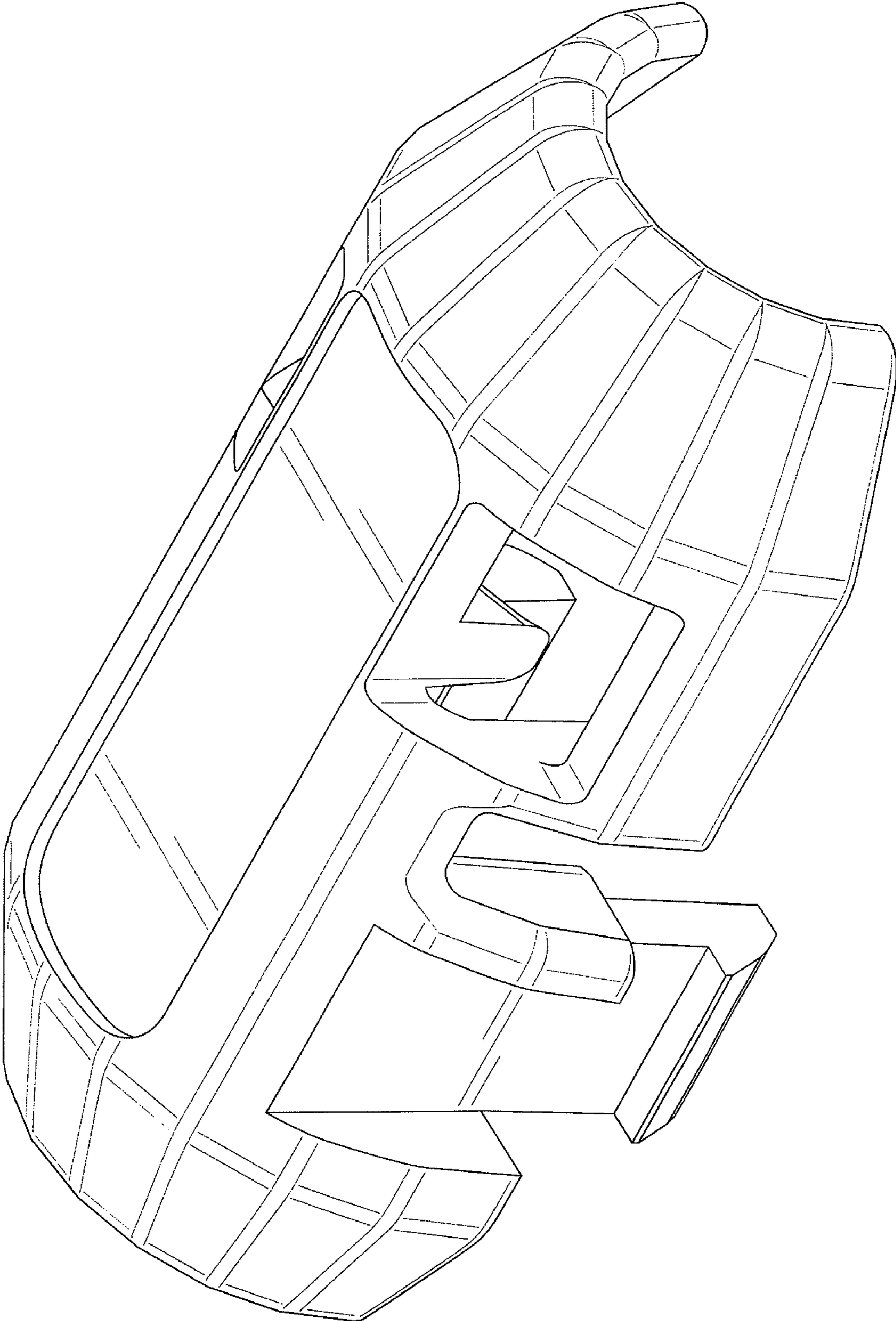

FIG. 9

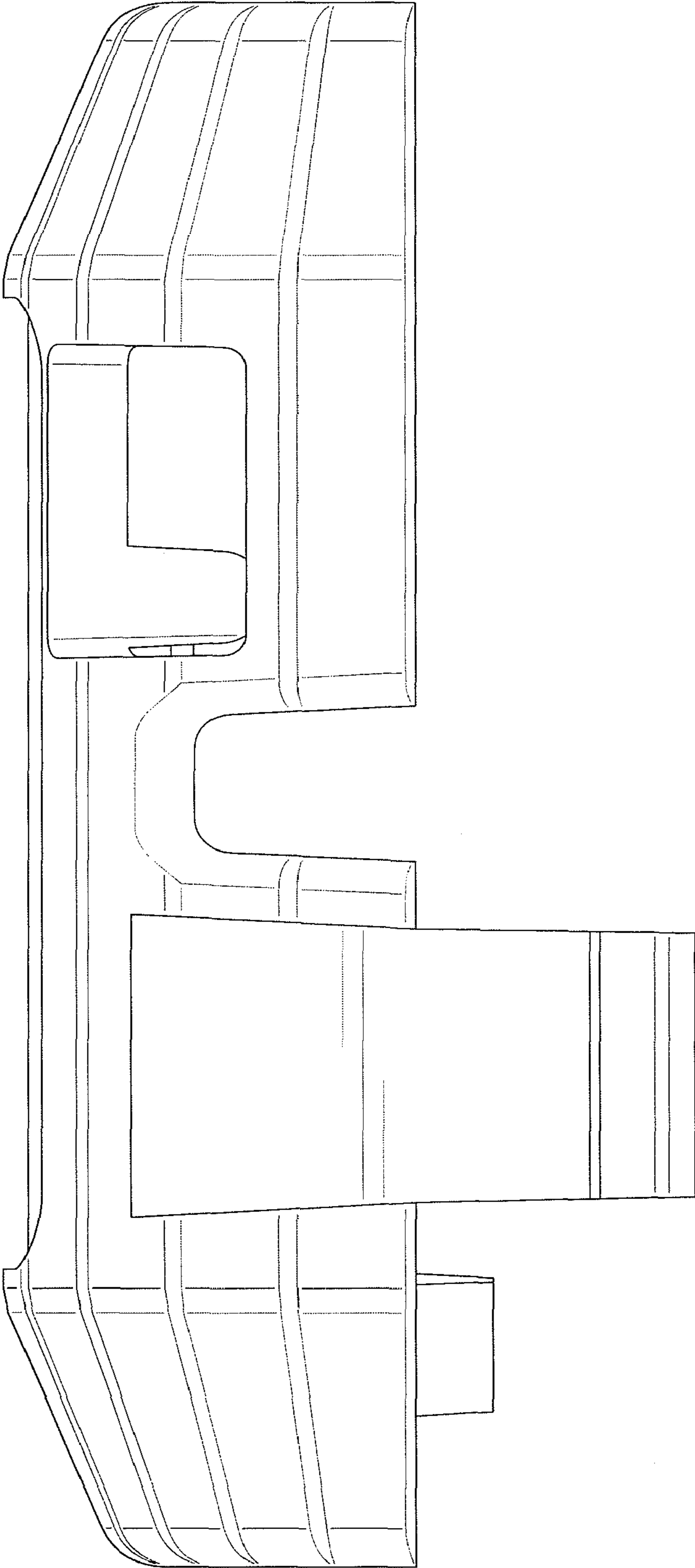

FIG. 10

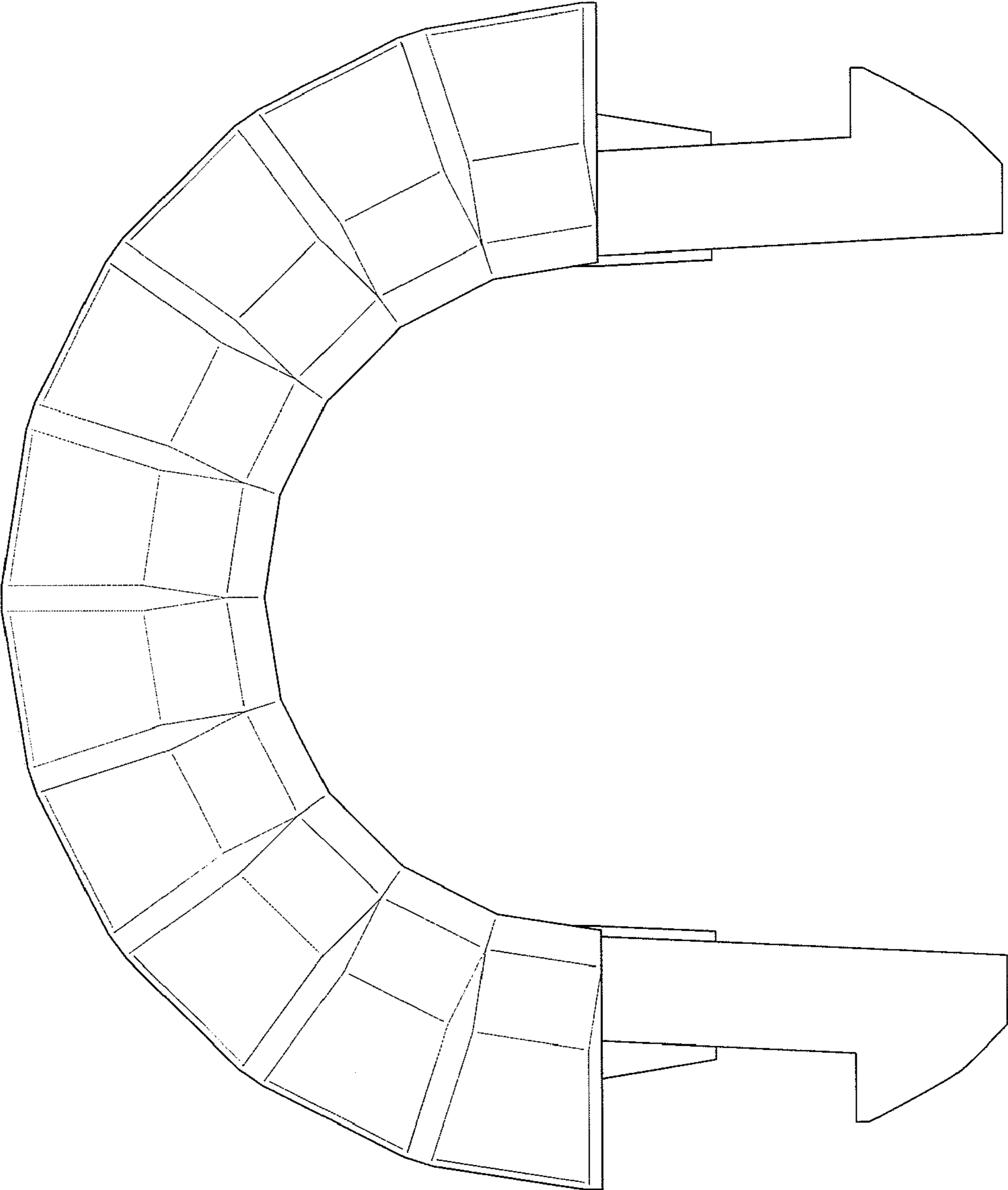

FIG. 11

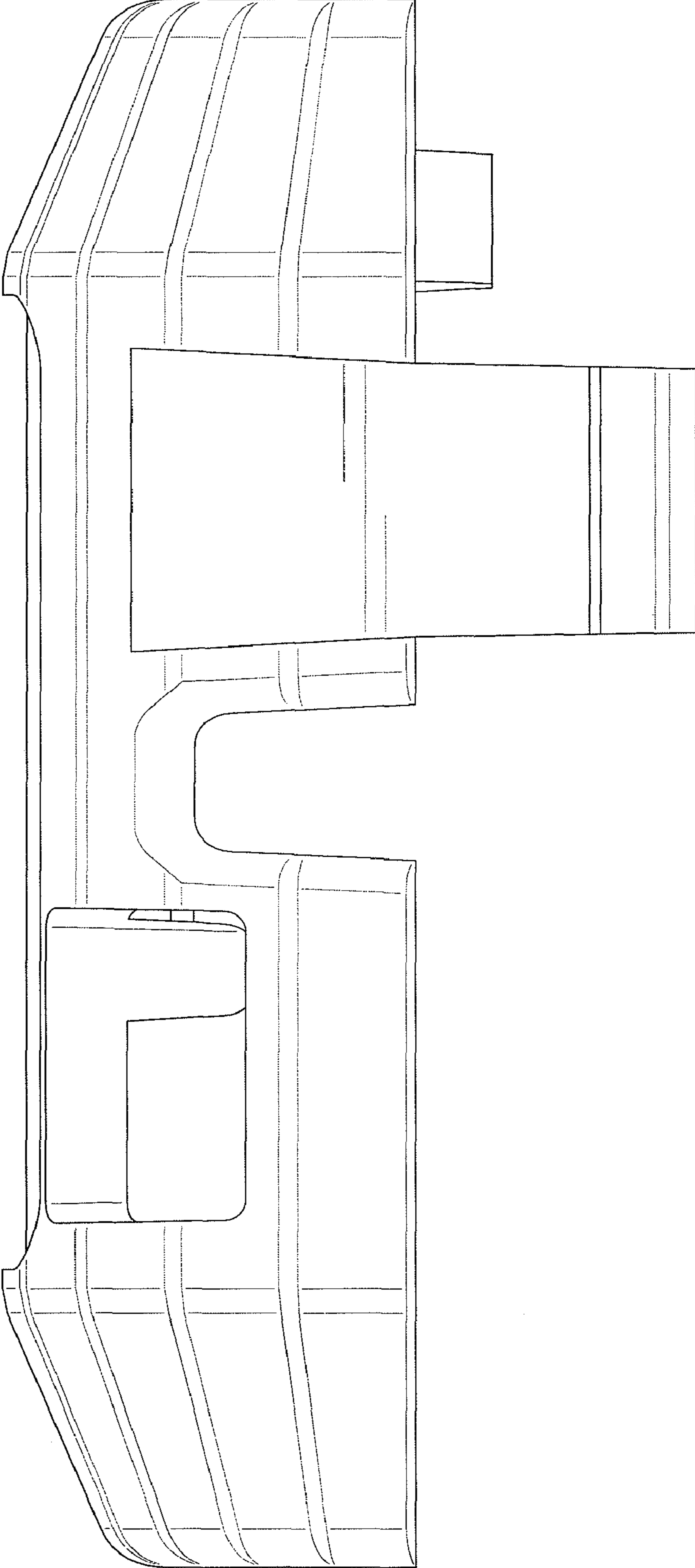

FIG. 12

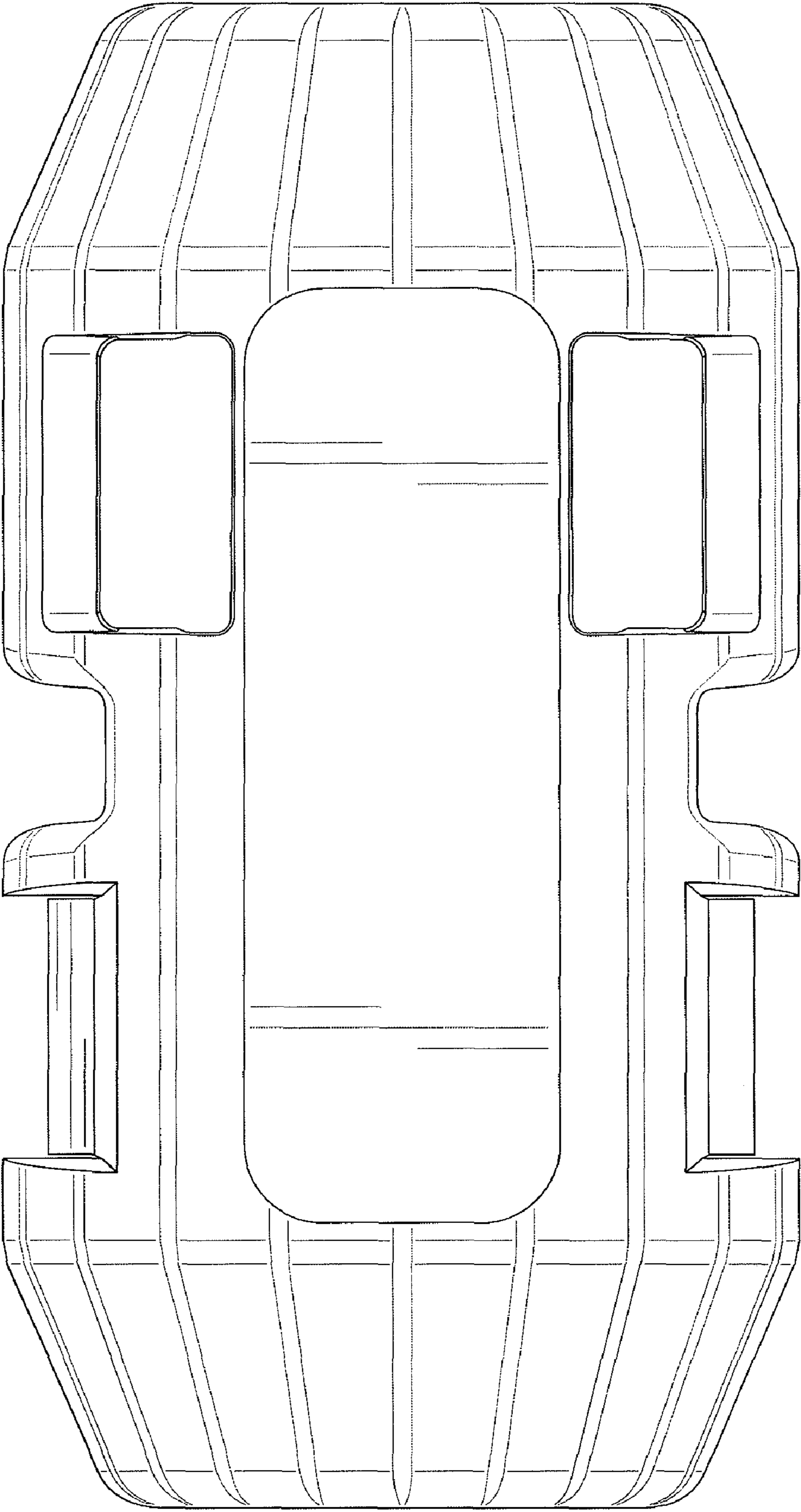

FIG. 13

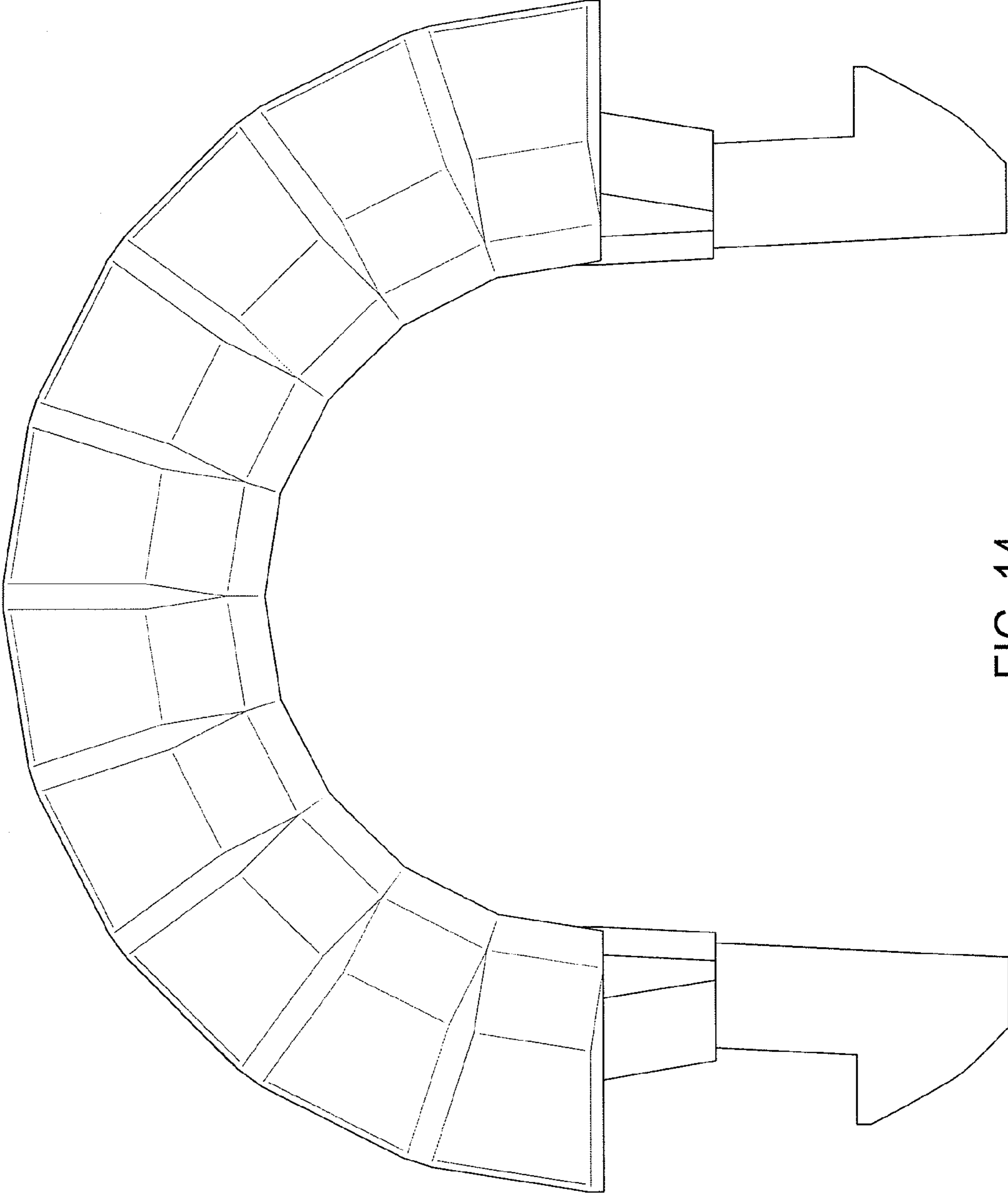

FIG. 14

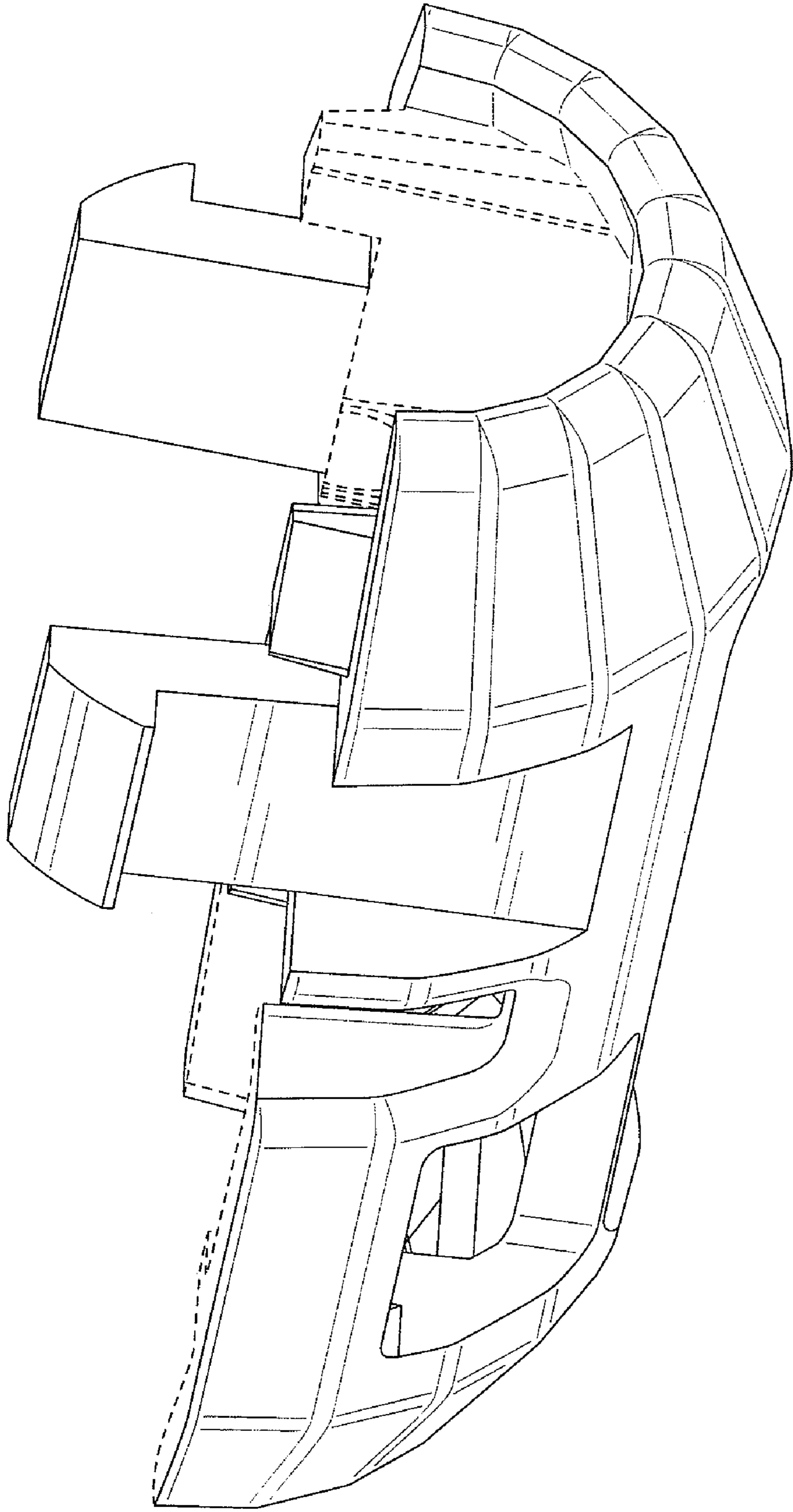

FIG. 15

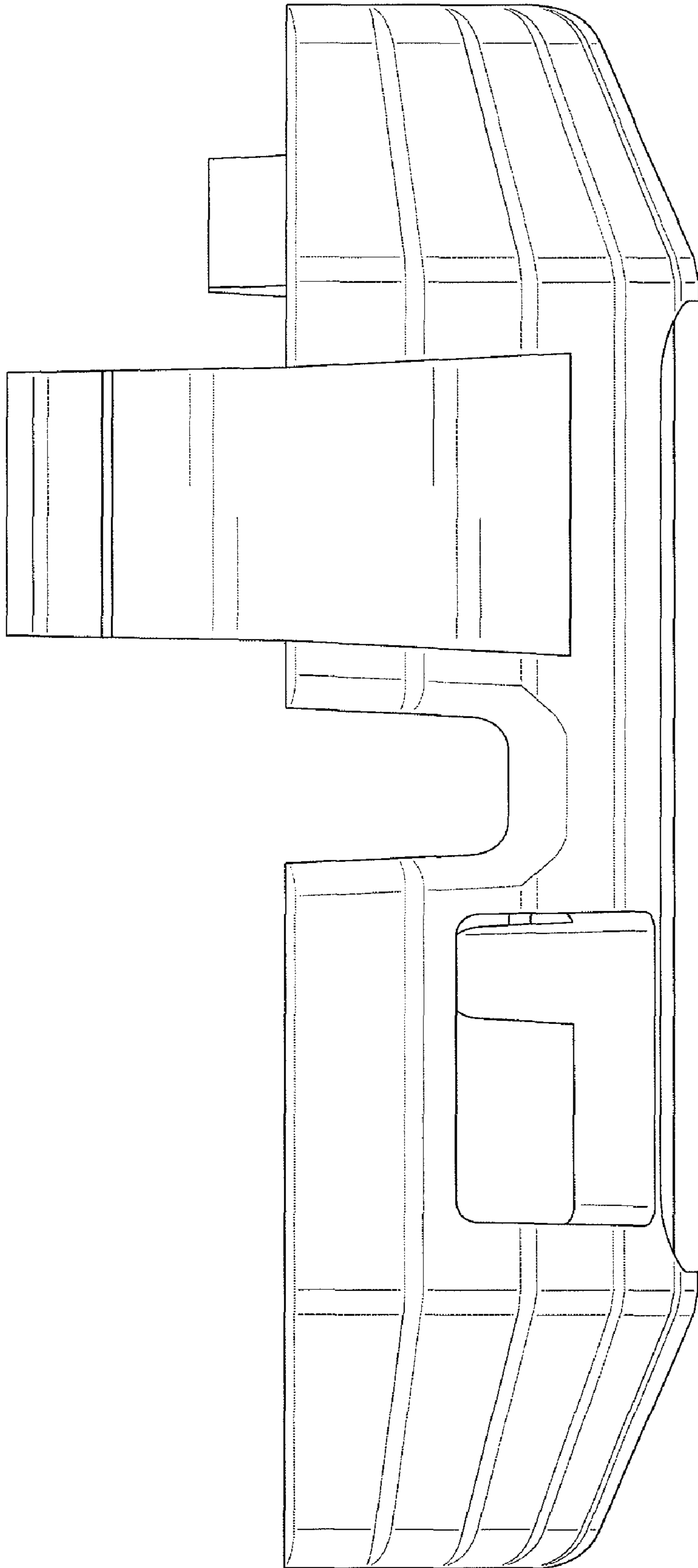

FIG. 16

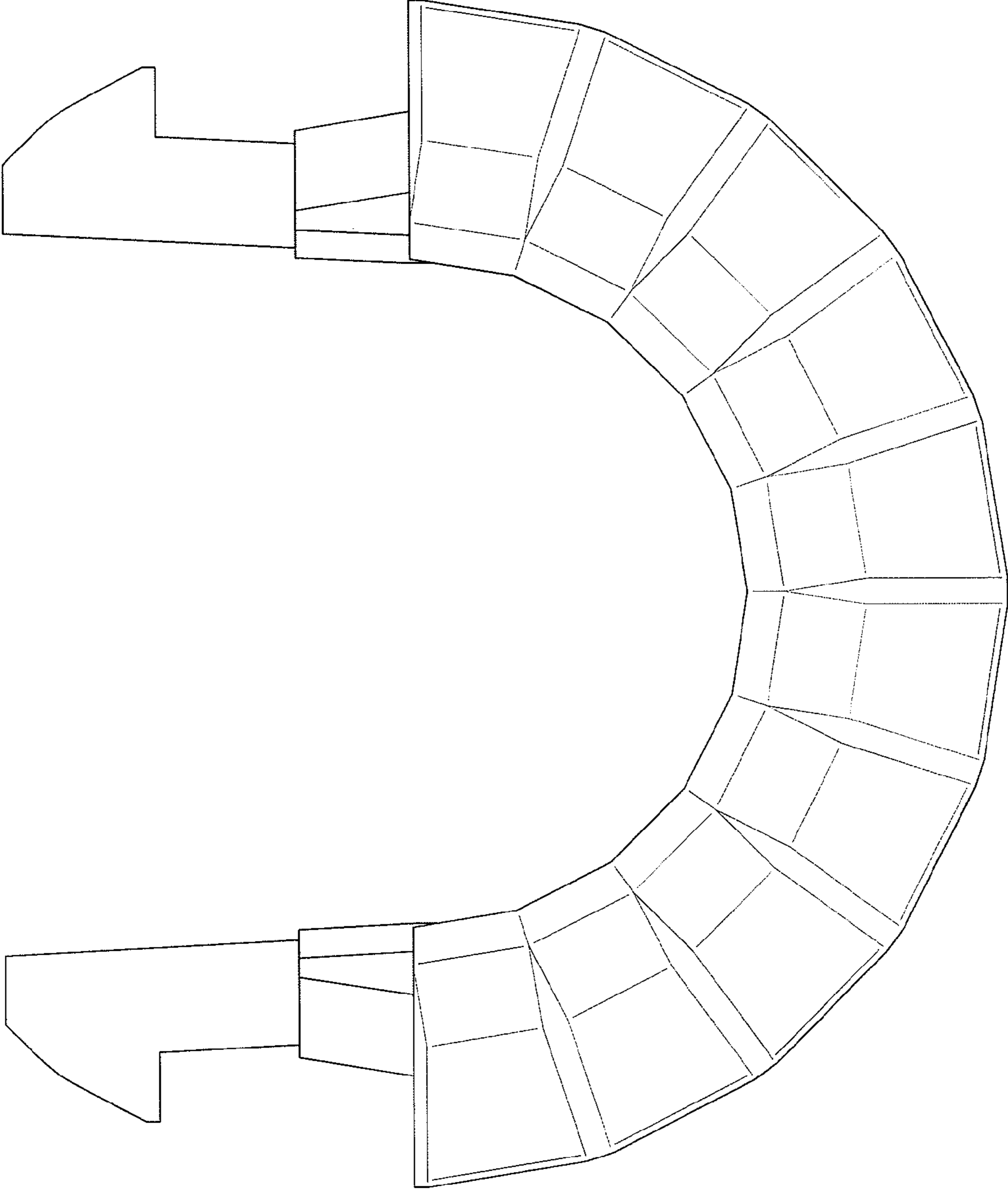

FIG. 17

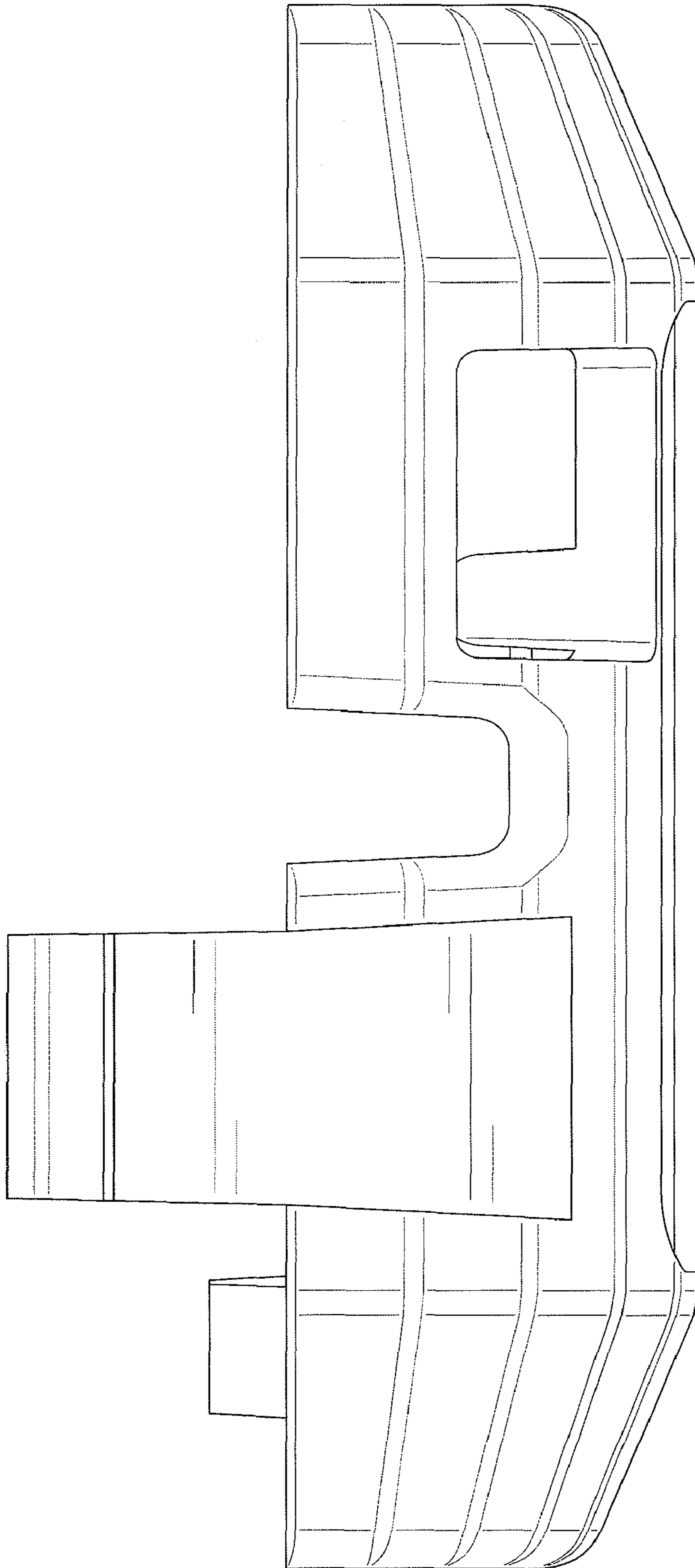

FIG. 18

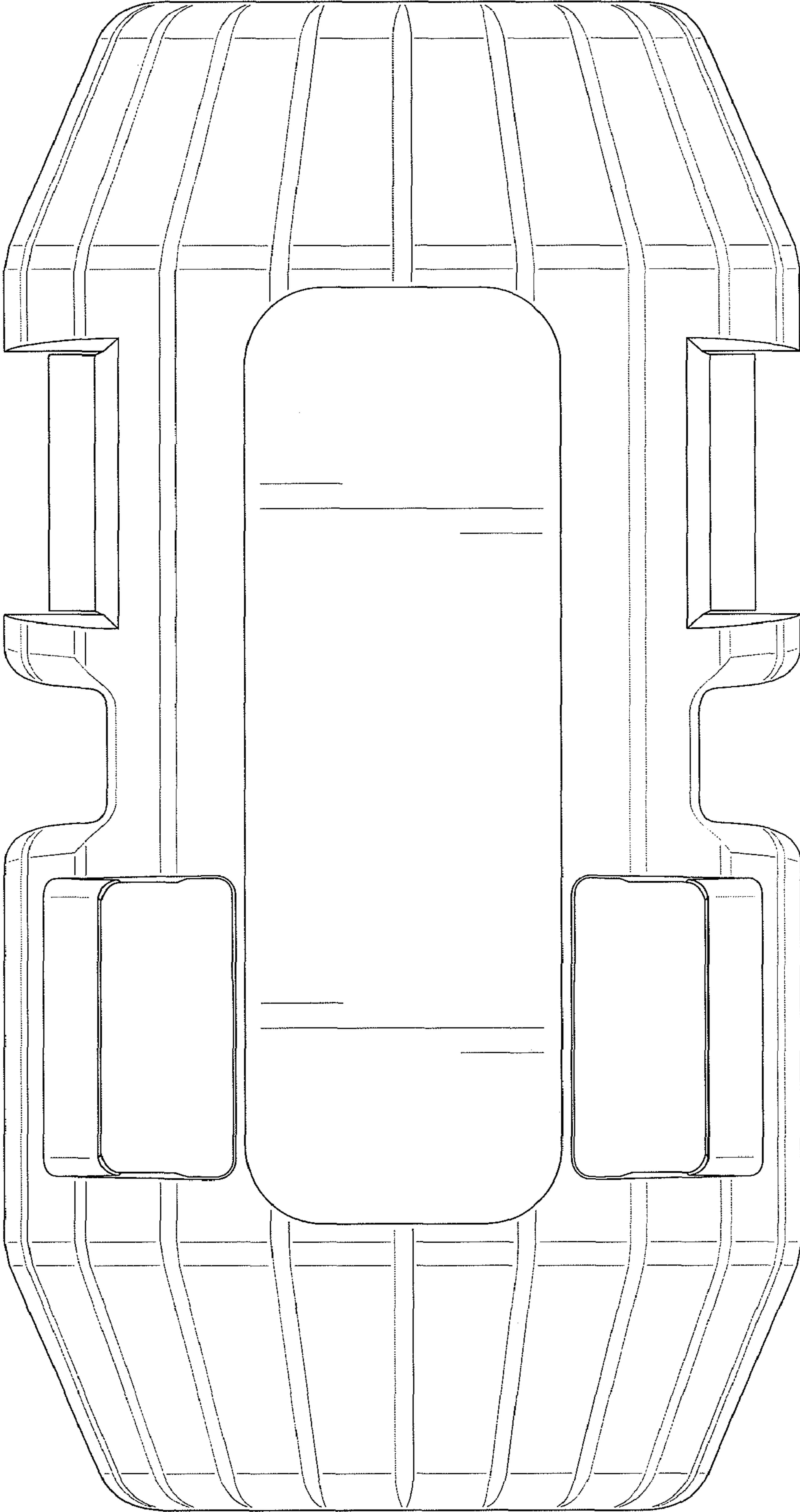

FIG. 19

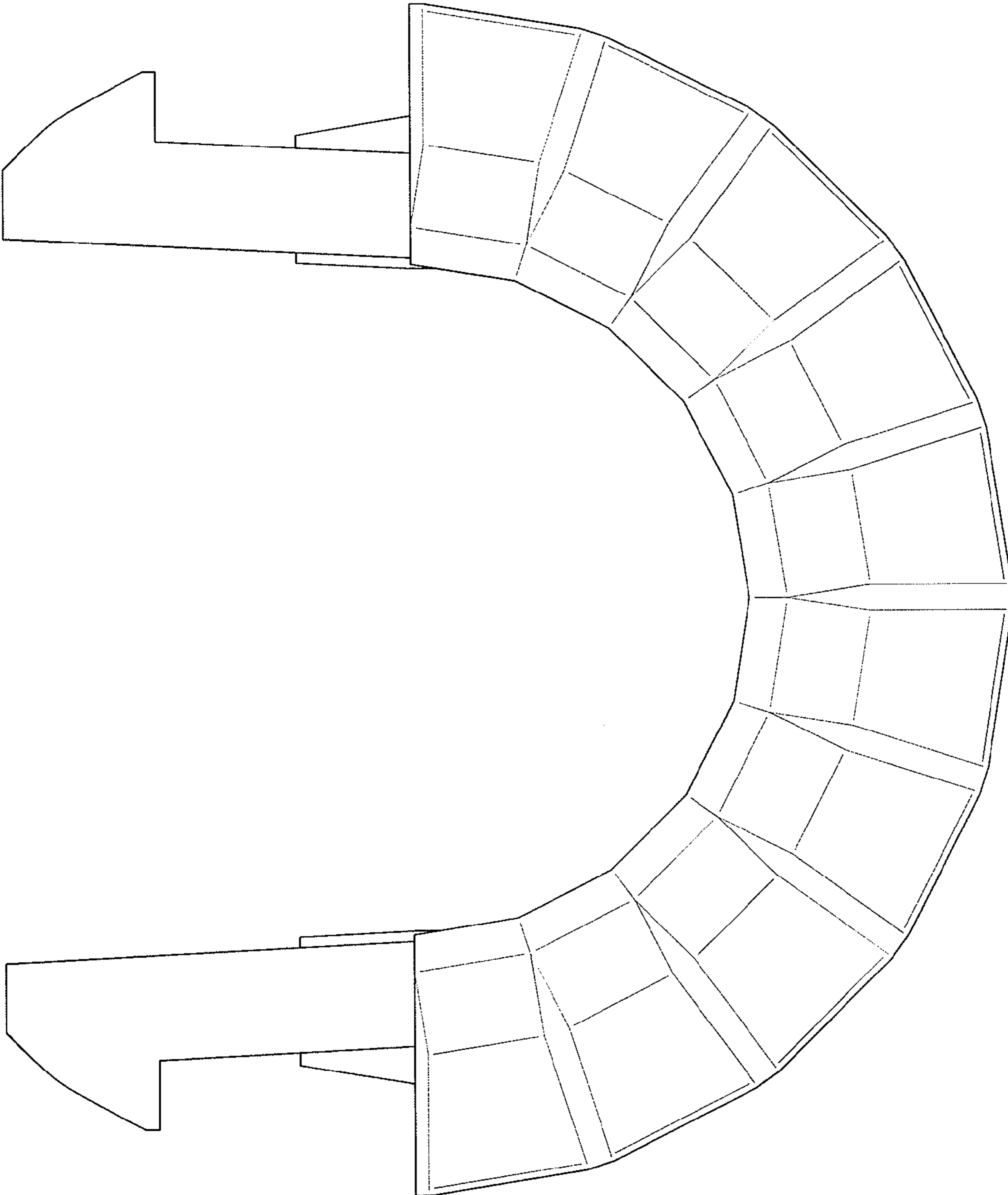

FIG. 20