



US00D674250S

(12) **United States Design Patent**
Maudsley

(10) **Patent No.:** **US D674,250 S**
(45) **Date of Patent:** **** Jan. 15, 2013**

- (54) **TOOTHPICK CONTAINER**
- (75) Inventor: **Russell Maudsley**, Douglas (GB)
- (73) Assignee: **Pik-Sel Limited**, Isle of Man (GB)
- (**) Term: **14 Years**
- (21) Appl. No.: **29/412,501**
- (22) Filed: **Feb. 3, 2012**
- (51) **LOC (9) Cl.** **07-99**
- (52) **U.S. Cl.** **D7/635**
- (58) **Field of Classification Search** D7/635,
D7/636; D3/201, 273, 274; D9/756; 132/321,
132/329, 328; 206/370, 37, 38, 83, 104,
206/380, 443
See application file for complete search history.

- 5,181,755 A * 1/1993 Stanwich et al. 206/104
- 5,415,276 A * 5/1995 Welton 206/104
- 5,855,215 A 1/1999 Clarke

* cited by examiner

Primary Examiner — Terry Wallace

(74) *Attorney, Agent, or Firm* — Reising Ethington P.C.

(57) **CLAIM**

The ornamental design for a toothpick container, as shown and described.

DESCRIPTION

FIG. 1 is a perspective view of the toothpick container shown in an open position and showing the inside of the container; FIG. 2 is a top view of the toothpick container; FIG. 3 is a rear view of the toothpick container; FIG. 4 is a front view of the toothpick container; FIG. 5 is a left side view of the toothpick container; FIG. 6 is a right side view of the toothpick container; FIG. 7 is a bottom view of the toothpick container; and, FIG. 8 is a perspective view of the toothpick container shown in a closed position.

(56) **References Cited**

U.S. PATENT DOCUMENTS

- D274,693 S * 7/1984 Cruz D9/756
- D306,235 S * 2/1990 Tamamura D3/295
- D316,934 S * 5/1991 Stanfield D3/284

1 Claim, 3 Drawing Sheets

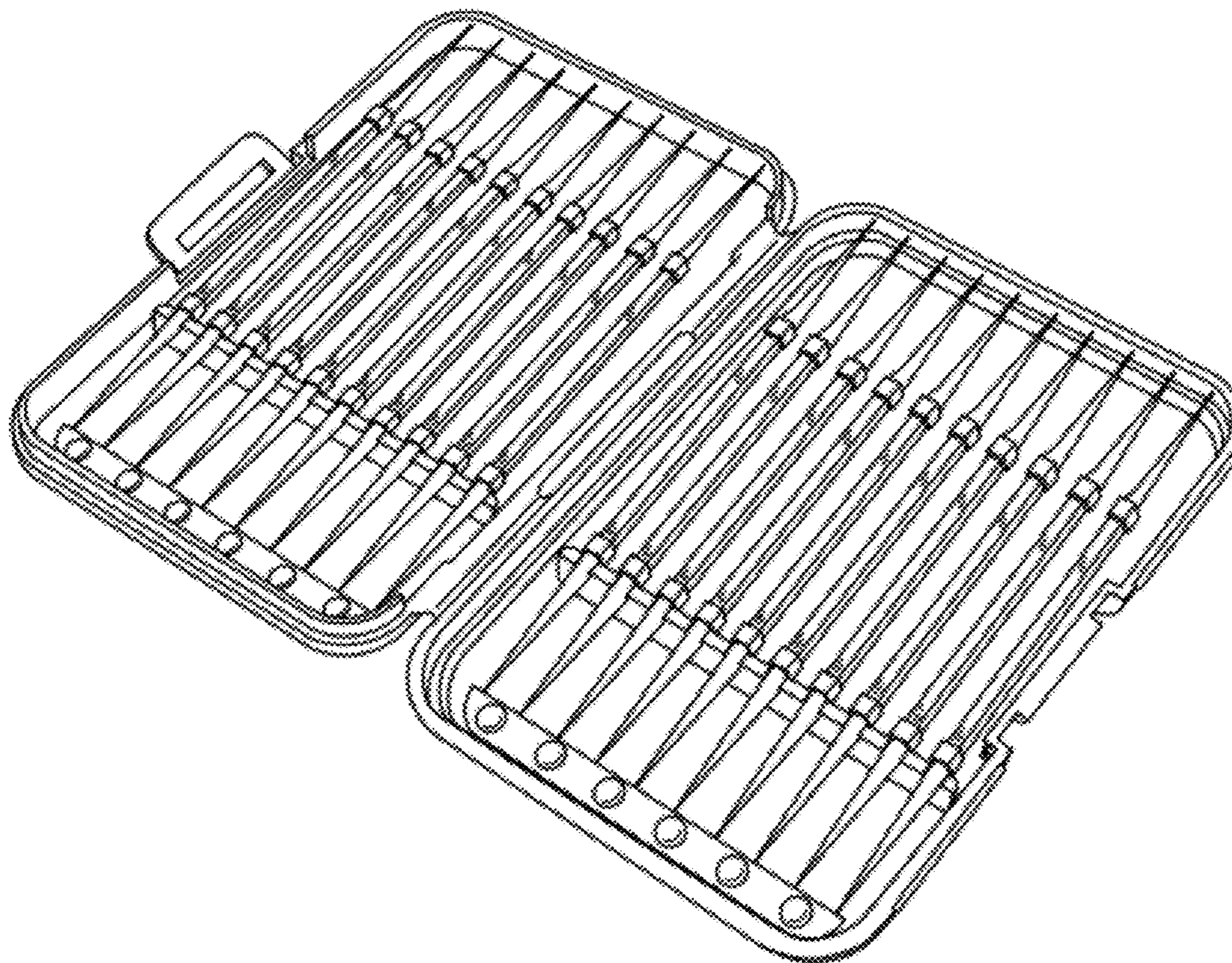

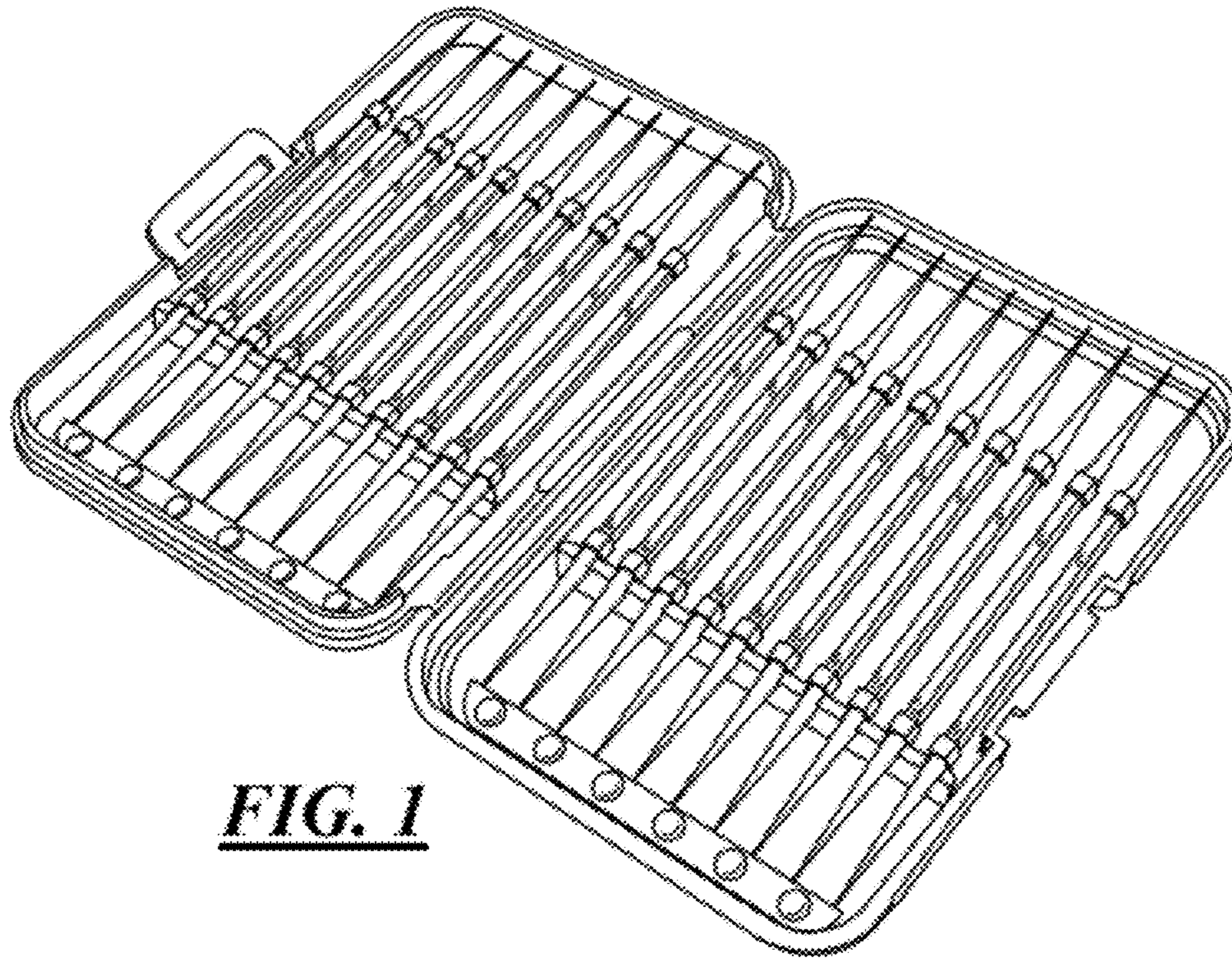

FIG. 1

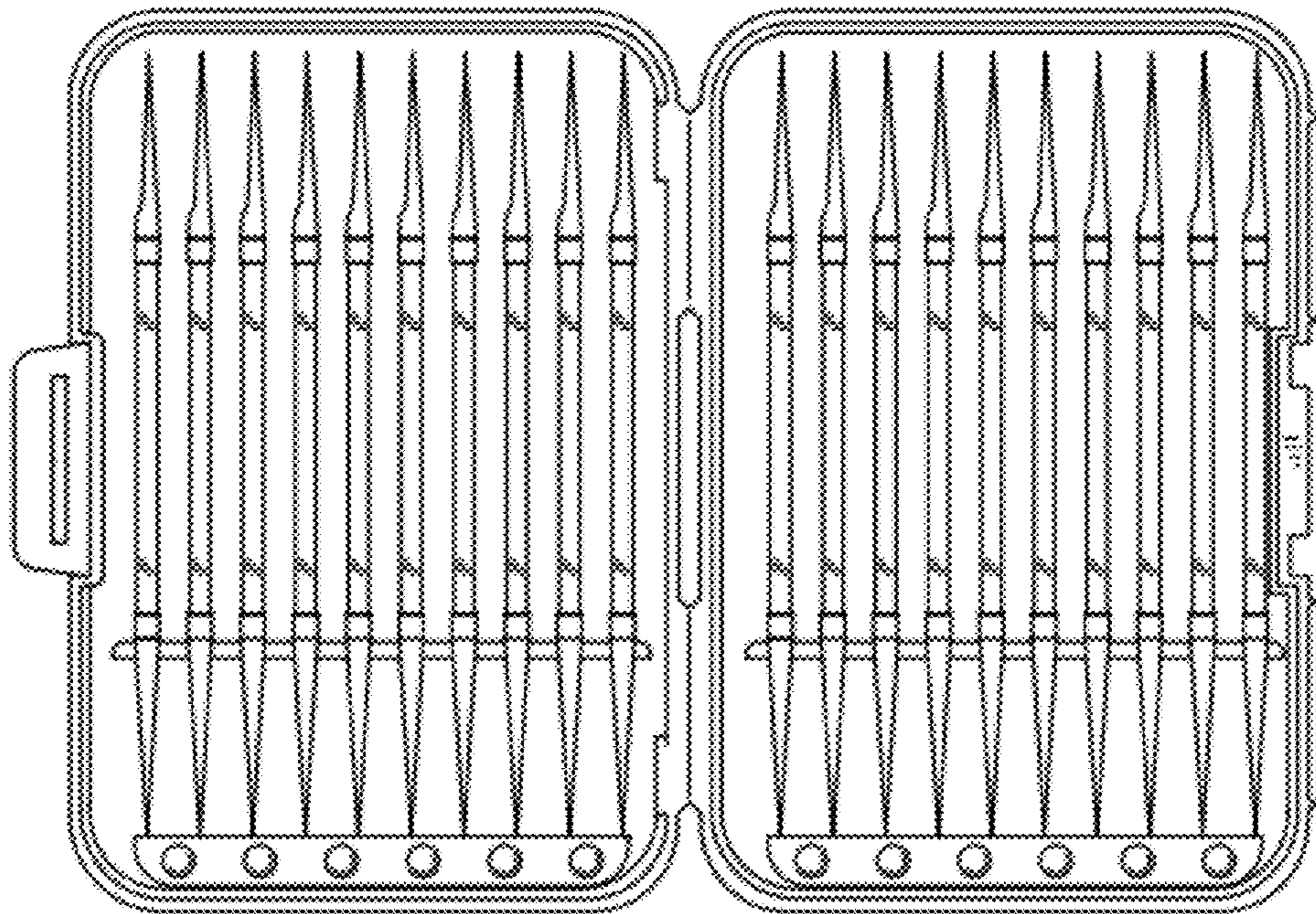

FIG. 2



FIG. 3



FIG. 4

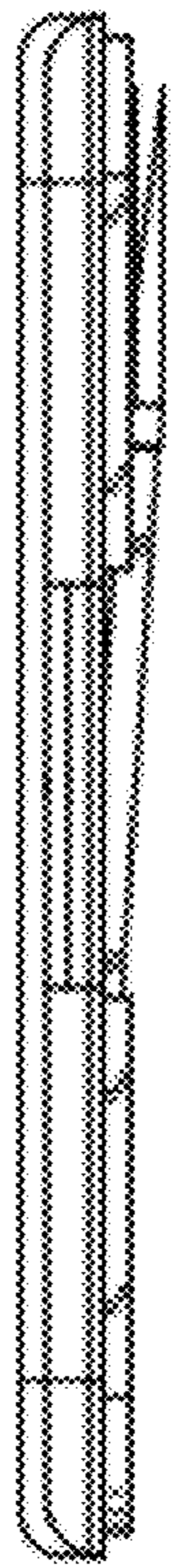

FIG. 5

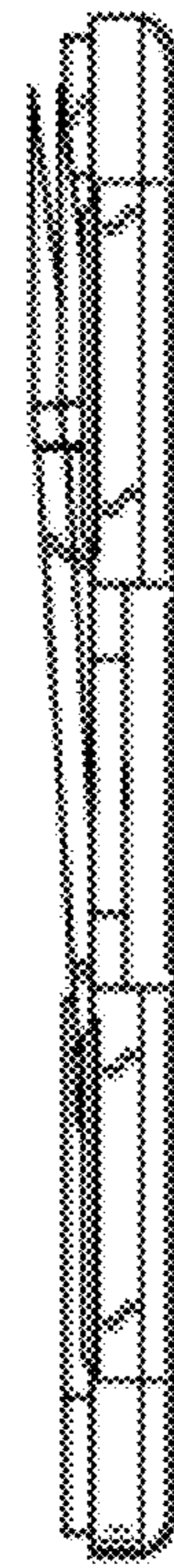

FIG. 6

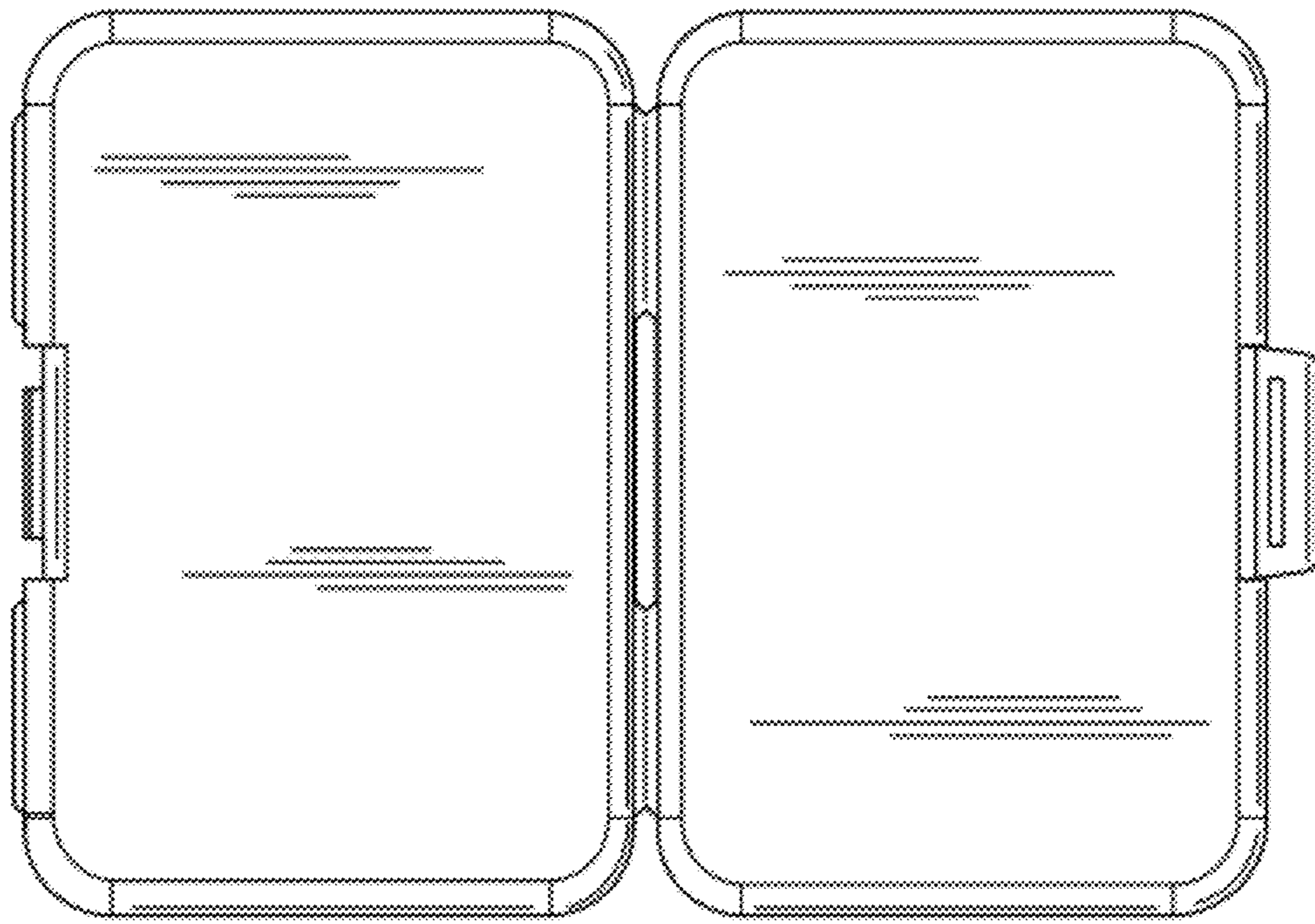

FIG. 7

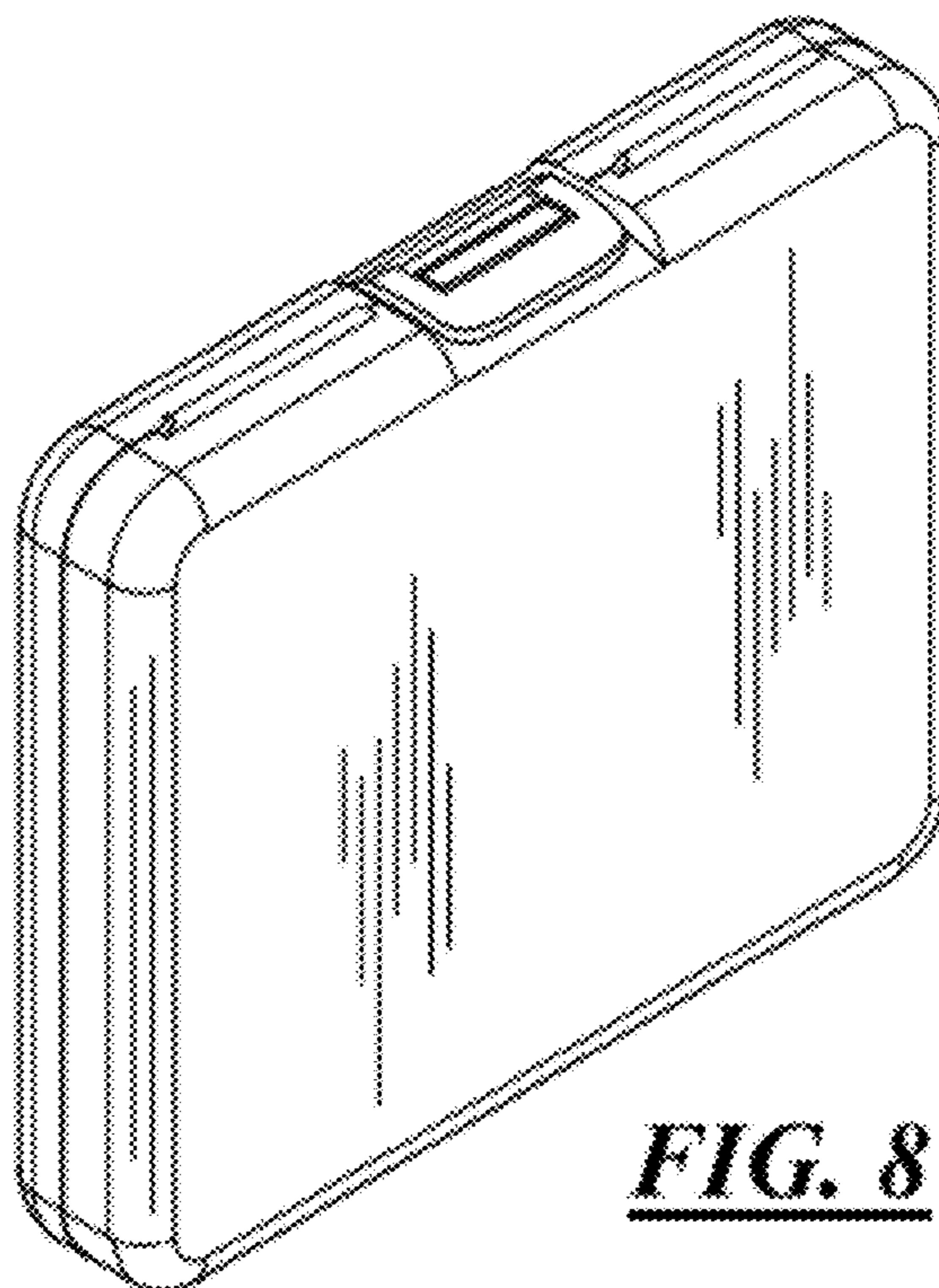

FIG. 8