



US00D674246S

(12) **United States Design Patent**
Scott et al.

(10) **Patent No.:** **US D674,246 S**
(45) **Date of Patent:** **** Jan. 15, 2013**

(54) **THERMALLY INSULATED FOOD CONTAINER**

(75) Inventors: **Emmon Scott**, Bloomfield Township, MI (US); **Julie A. Becker**, Tecumseh, MI (US); **Sharon A. Hoffman**, St. Clair Shores, MI (US); **Michael R. Hofstetter**, Bloomfield Hills, MI (US)

(73) Assignee: **Shen Manufacturing Company Incorporated**, West Conshohocken, PA (US)

(**) Term: **14 Years**

(21) Appl. No.: **29/385,165**

(22) Filed: **Feb. 9, 2011**

(51) **LOC (9) Cl.** **07-01**

(52) **U.S. Cl.** **D7/607**

(58) **Field of Classification Search** D7/605, D7/607, 601, 602, 709; D6/610; 219/387, 219/620-622; 383/97, 99; 428/12; 220/739
See application file for complete search history.

(56) **References Cited**

U.S. PATENT DOCUMENTS

3,428,103	A *	2/1969	Walsh	383/97
4,578,814	A *	3/1986	Skamser	383/99
D287,921	S *	1/1987	Skamser	D7/607

(Continued)

OTHER PUBLICATIONS

Insulated Pizza Delivery Bag, Nisbets, © 2008-2012 by Pizza Bags, Inc. [online], [site visited Aug. 25, 2012]. Available from Internet, <URL: <http://www.nisbets.co.uk/Insulated-Pizza-Delivery-Bag/S481/ProductDetail.raction>>.*

(Continued)

Primary Examiner — Jeffrey D Asch
(74) *Attorney, Agent, or Firm* — John F. A. Earley, III; Frank J. Bonini, Jr.; Harding, Earley, Follmer & Frailey, P.C.

(57) **CLAIM**
The ornamental design for thermally insulated food container, as shown and described.

DESCRIPTION

FIG. 1 is a front/right side isometric view of a first embodiment of the thermally insulated food container of the present invention;
FIG. 2 is a front elevational view of the embodiment of FIG. 1;
FIG. 3 is a rear elevational view of the embodiment of FIG. 1;
FIG. 4 is a right side elevational view of the embodiment of FIG. 1;
FIG. 5 is a left side elevational view of the embodiment of FIG. 1;
FIG. 6 is a top view of the embodiment of FIG. 1;
FIG. 7 is a bottom view of the embodiment of FIG. 1;
FIG. 8 is a front/right side isometric view of a second embodiment of the thermally insulated food container of the present invention;
FIG. 9 is a front elevational view of the embodiment of FIG. 8;
FIG. 10 is a rear elevational view of the embodiment of FIG. 8;
FIG. 11 is a right side elevational view of the embodiment of FIG. 8;
FIG. 12 is a left side elevational view of the embodiment of FIG. 8;
FIG. 13 is a top view of the embodiment of FIG. 8; and, FIG. 14 is a bottom view of the embodiment of FIG. 8.
The broken lines shown throughout the drawing views are intended to indicate stitching.

1 Claim, 10 Drawing Sheets

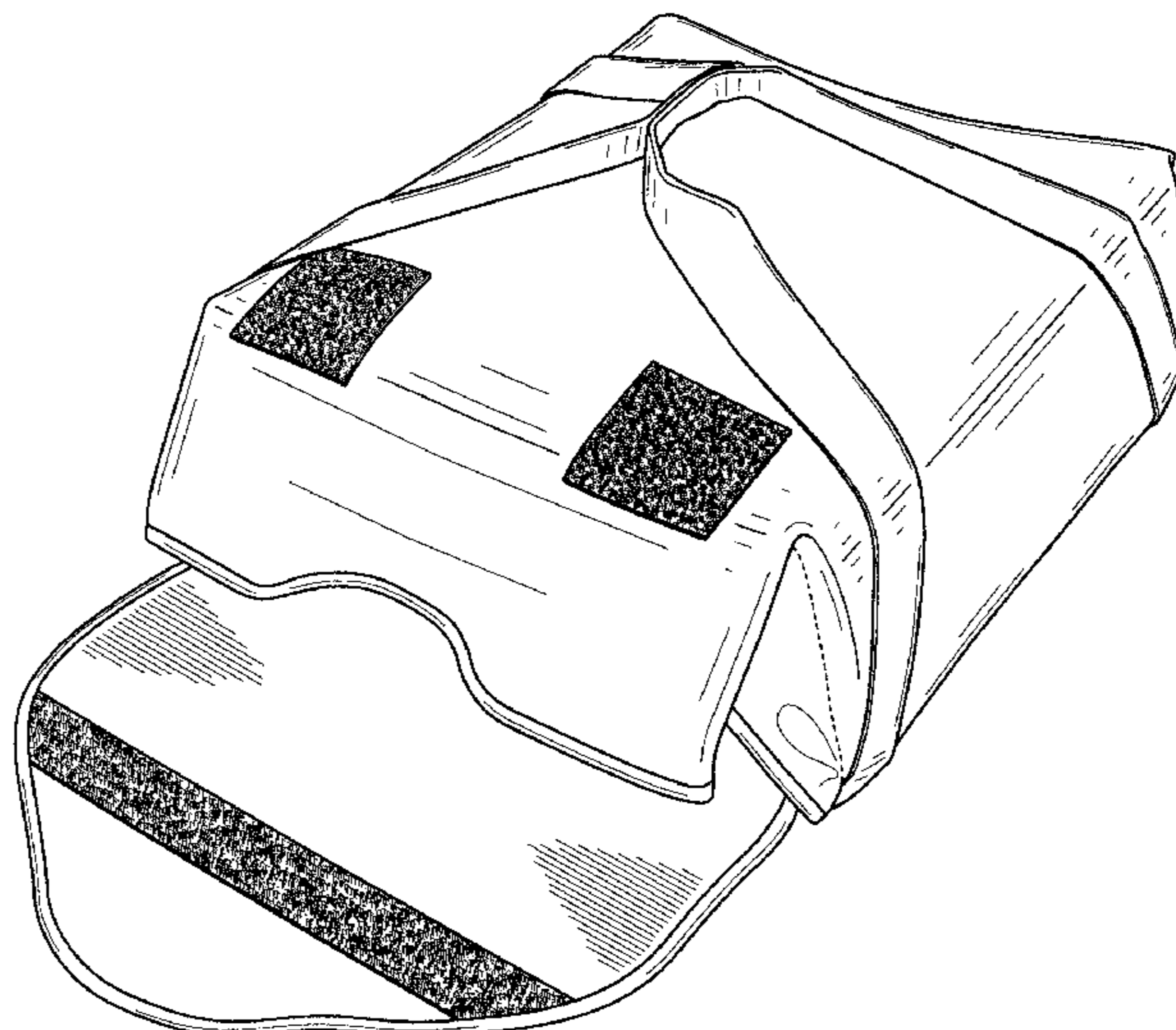
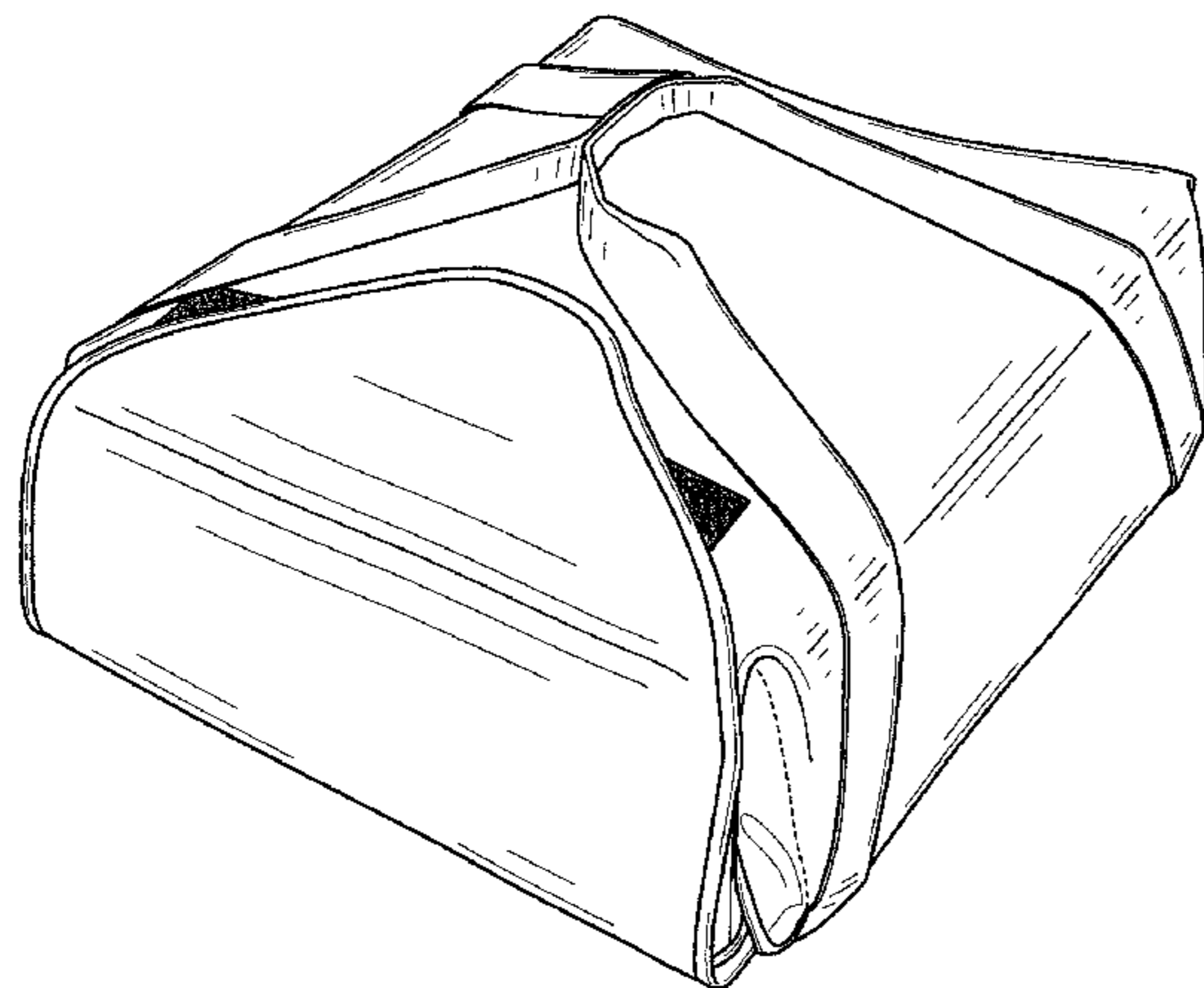

US D674,246 S

Page 2

U.S. PATENT DOCUMENTS

D294,912 S * 3/1988 Rivera D7/607
4,802,233 A * 1/1989 Skamser 383/15
D372,858 S * 8/1996 Sunley D8/499
5,892,202 A * 4/1999 Baldwin et al. 219/387
6,018,143 A * 1/2000 Check 219/387
6,169,270 B1 * 1/2001 Check 219/387
6,232,585 B1 * 5/2001 Clothier et al. 219/620
6,281,477 B1 * 8/2001 Forrester et al. 219/387
6,390,345 B1 * 5/2002 Brown et al. 224/578
6,433,313 B1 * 8/2002 Owens et al. 219/387
6,512,211 B1 * 1/2003 Lockhart et al. 219/621
6,861,628 B2 * 3/2005 Owens et al. 219/622
7,034,254 B2 * 4/2006 Grabowski et al. 219/387

D522,811 S * 6/2006 Martinez et al. D7/607
7,597,478 B2 * 10/2009 Pruchnicki et al. 383/40
D627,199 S * 11/2010 Pruchnicki D7/607
8,168,923 B2 * 5/2012 Wong et al. 219/387
D664,009 S * 7/2012 Scott et al. D7/607

OTHER PUBLICATIONS

12" - 14" Pizza Delivery Bag (Red), Delivery Bags USA, © 2008-2012 by Pizza Bags, Inc. [online], [site visited Aug. 25, 2012]. Available from Internet, <URL: <http://www.deliverybagsusa.com/1214pizzadeliverybagred-p-20.html>>.*

* cited by examiner

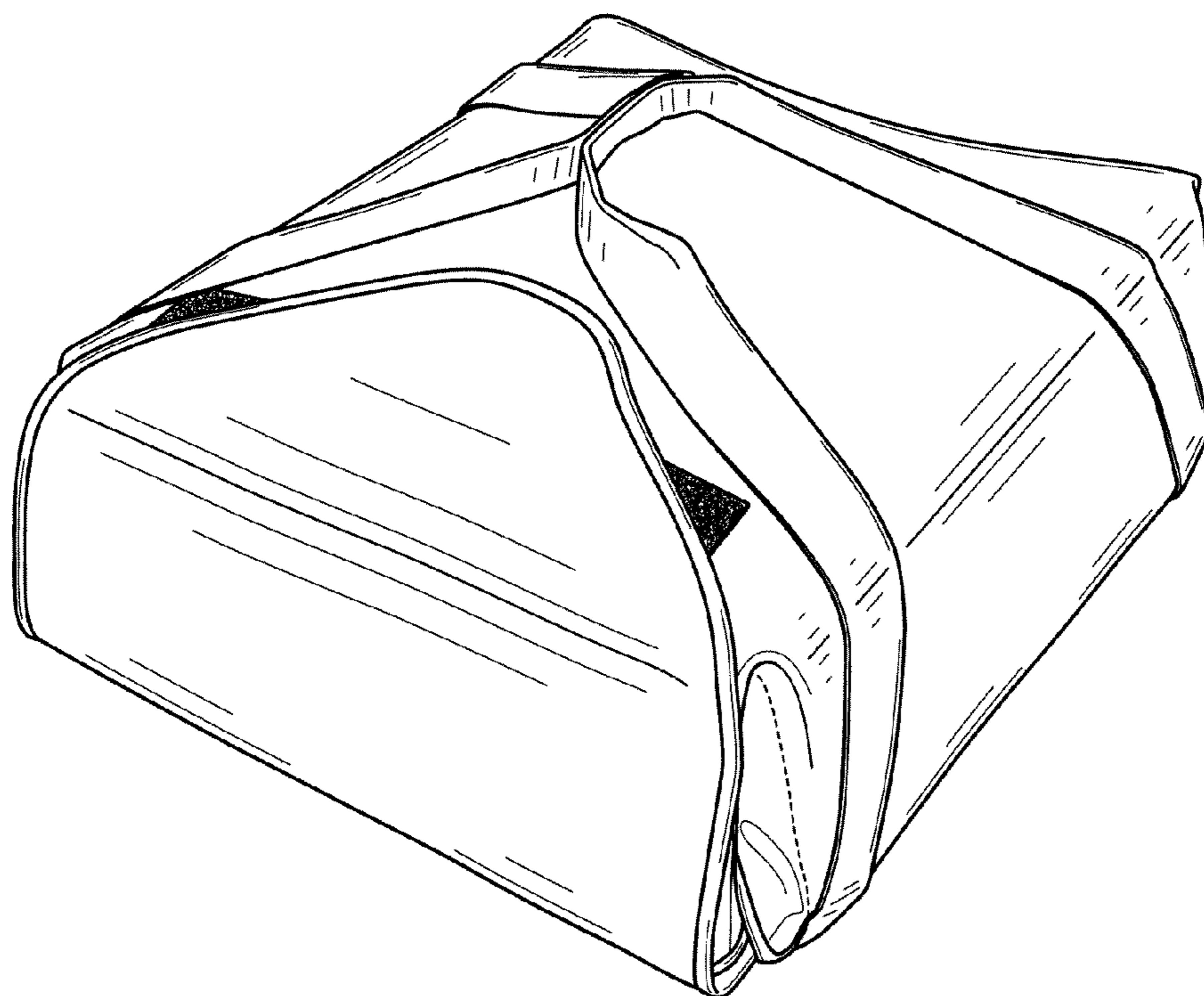

FIG. 1

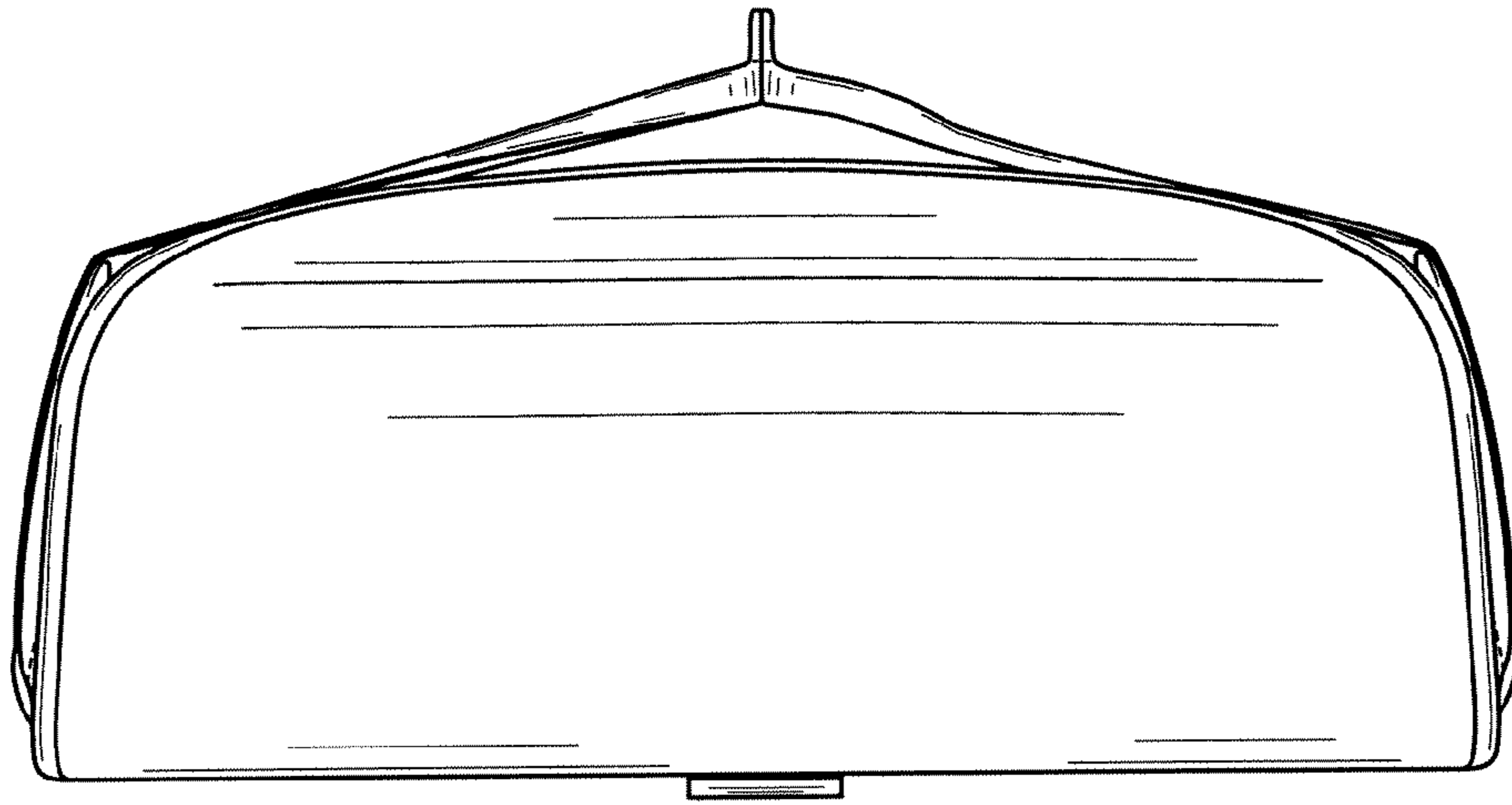

FIG. 2

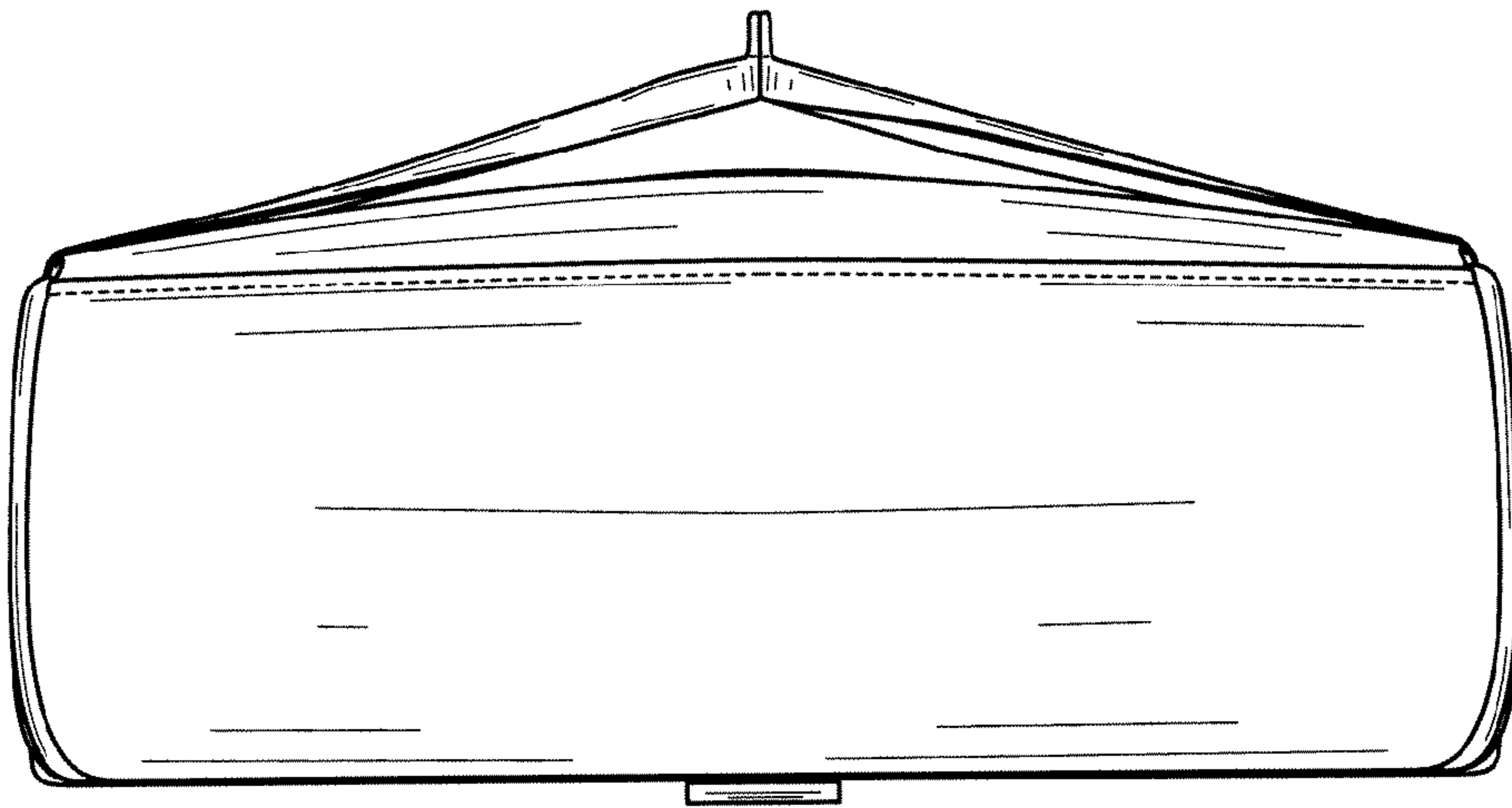

FIG. 3

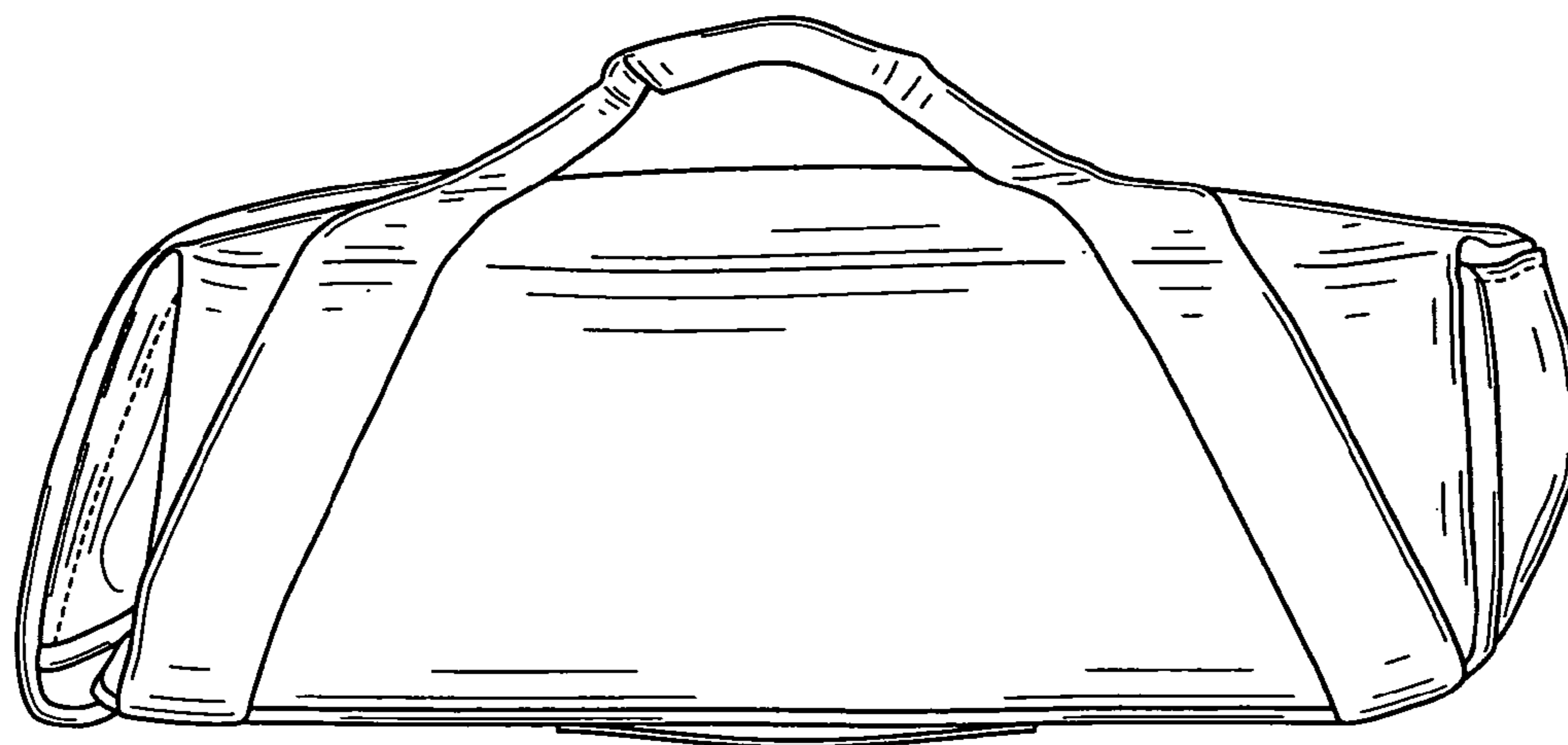

FIG. 4

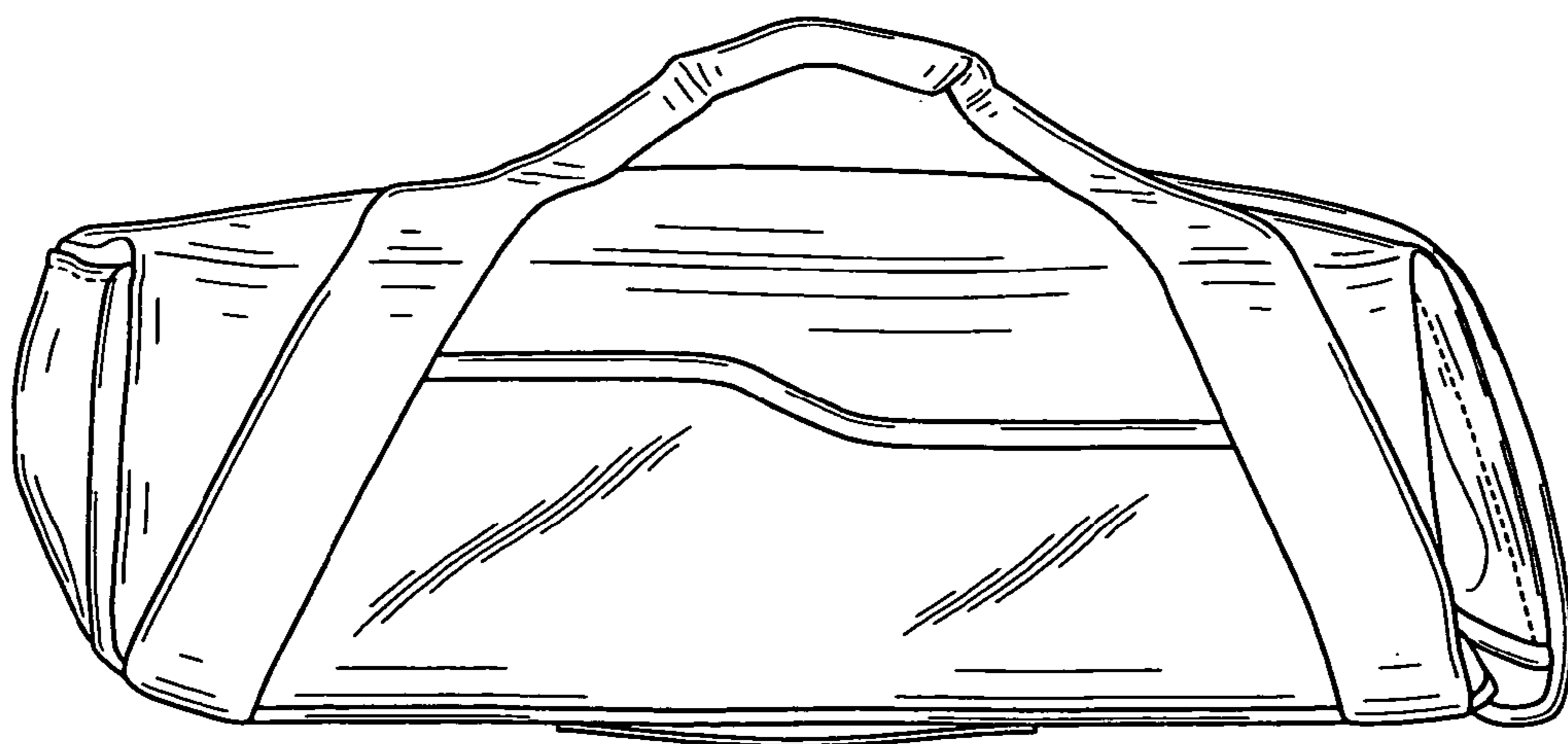

FIG. 5

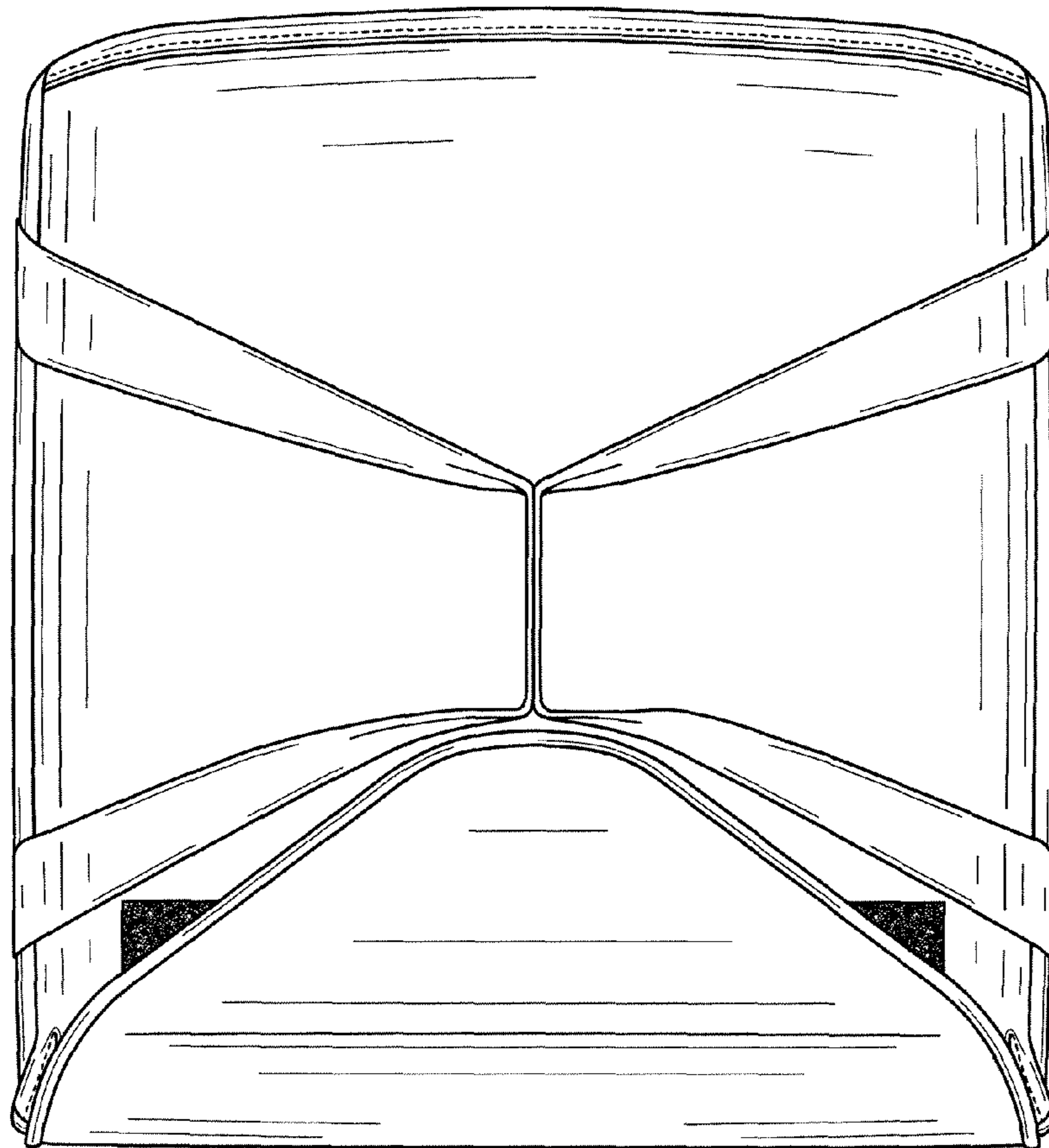

FIG. 6

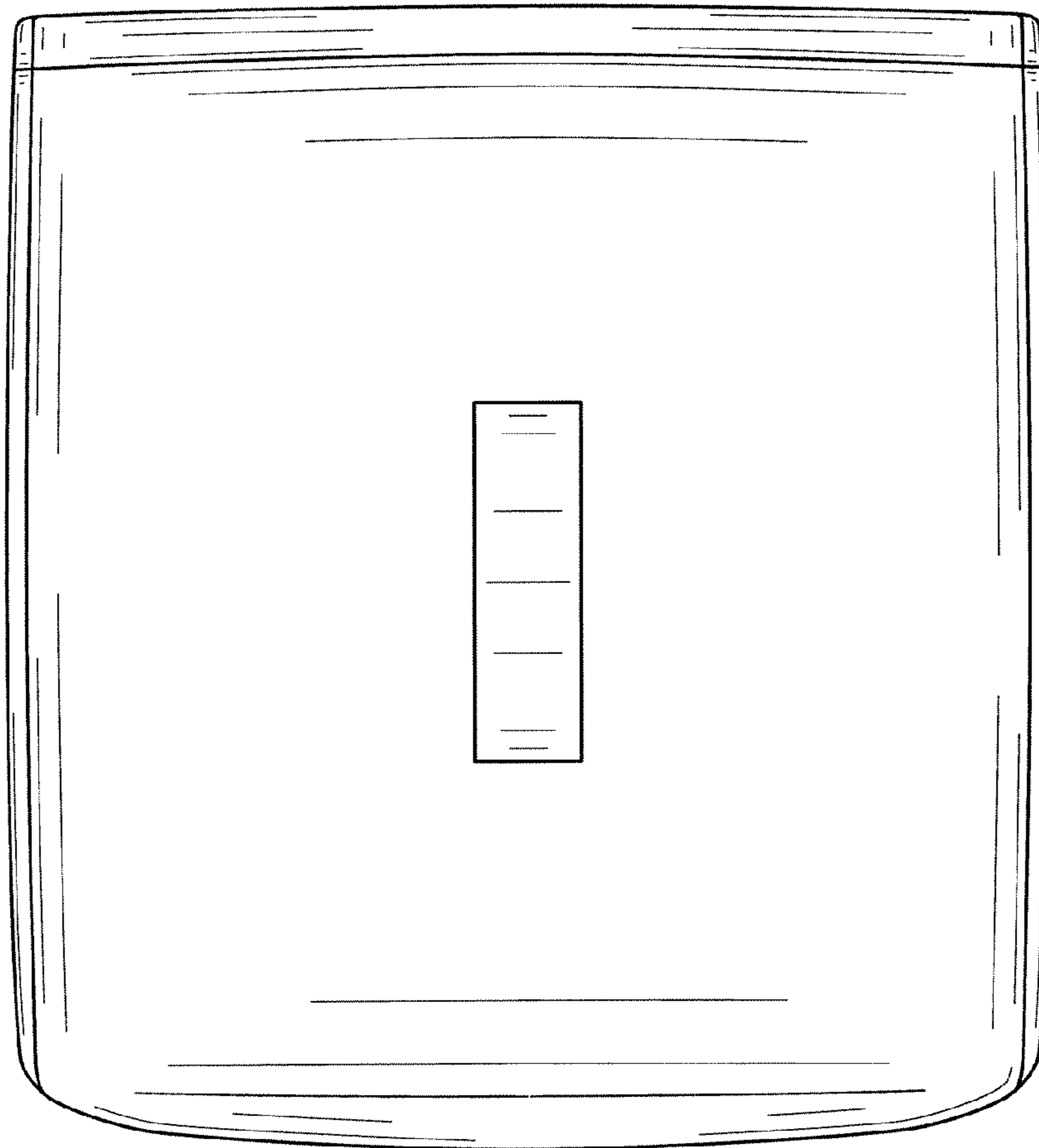

FIG. 7

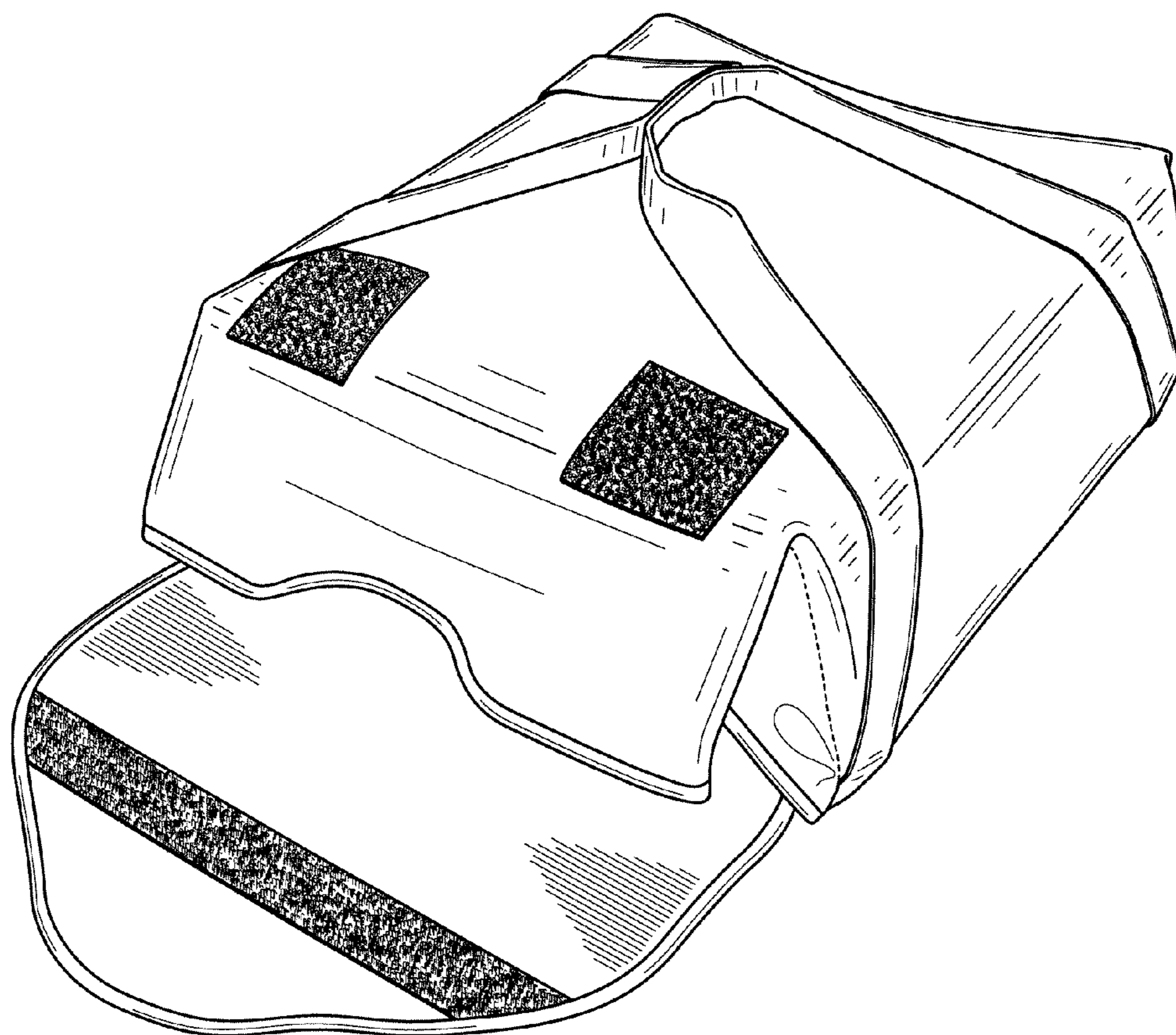

FIG. 8

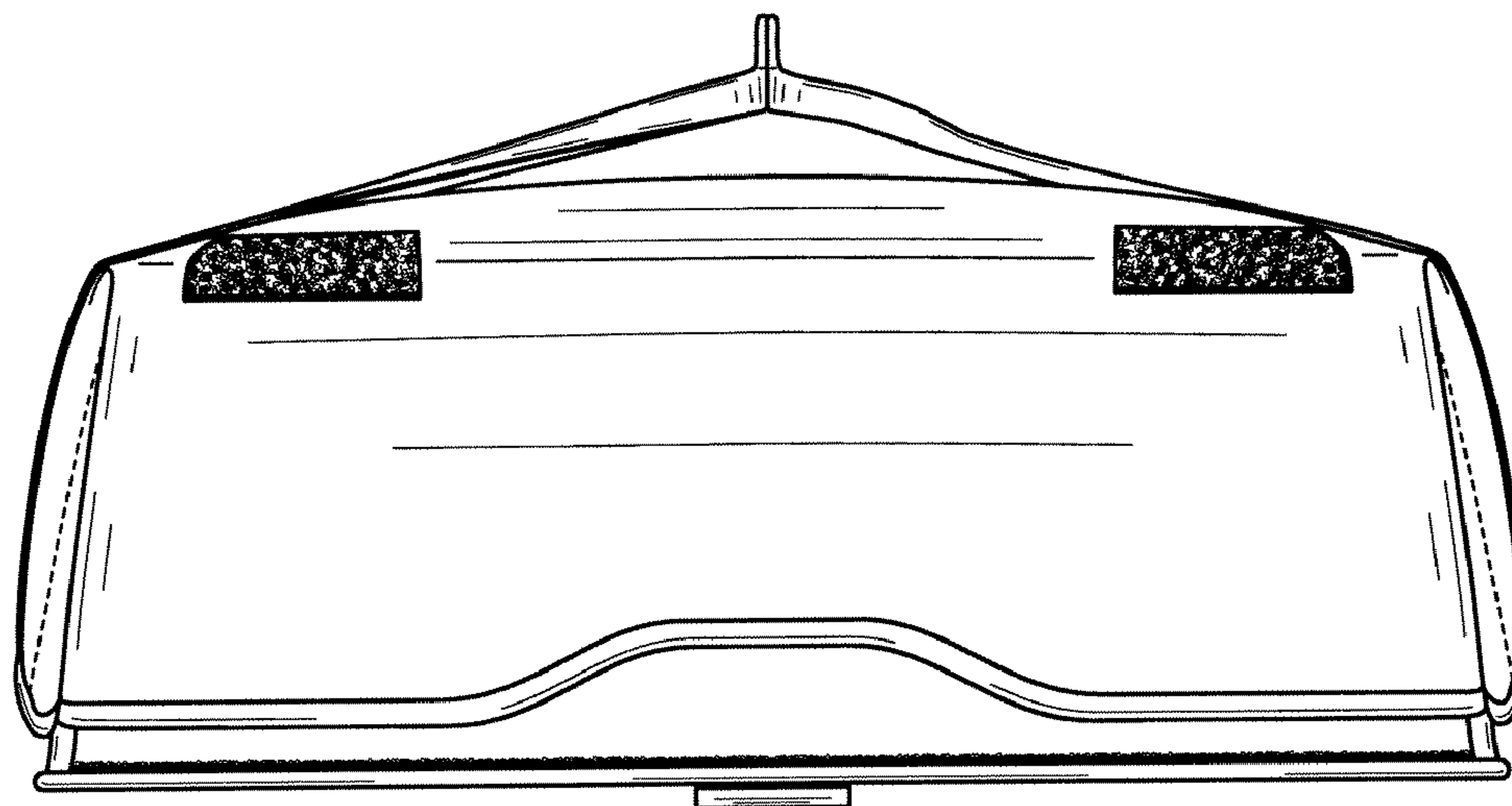

FIG. 9

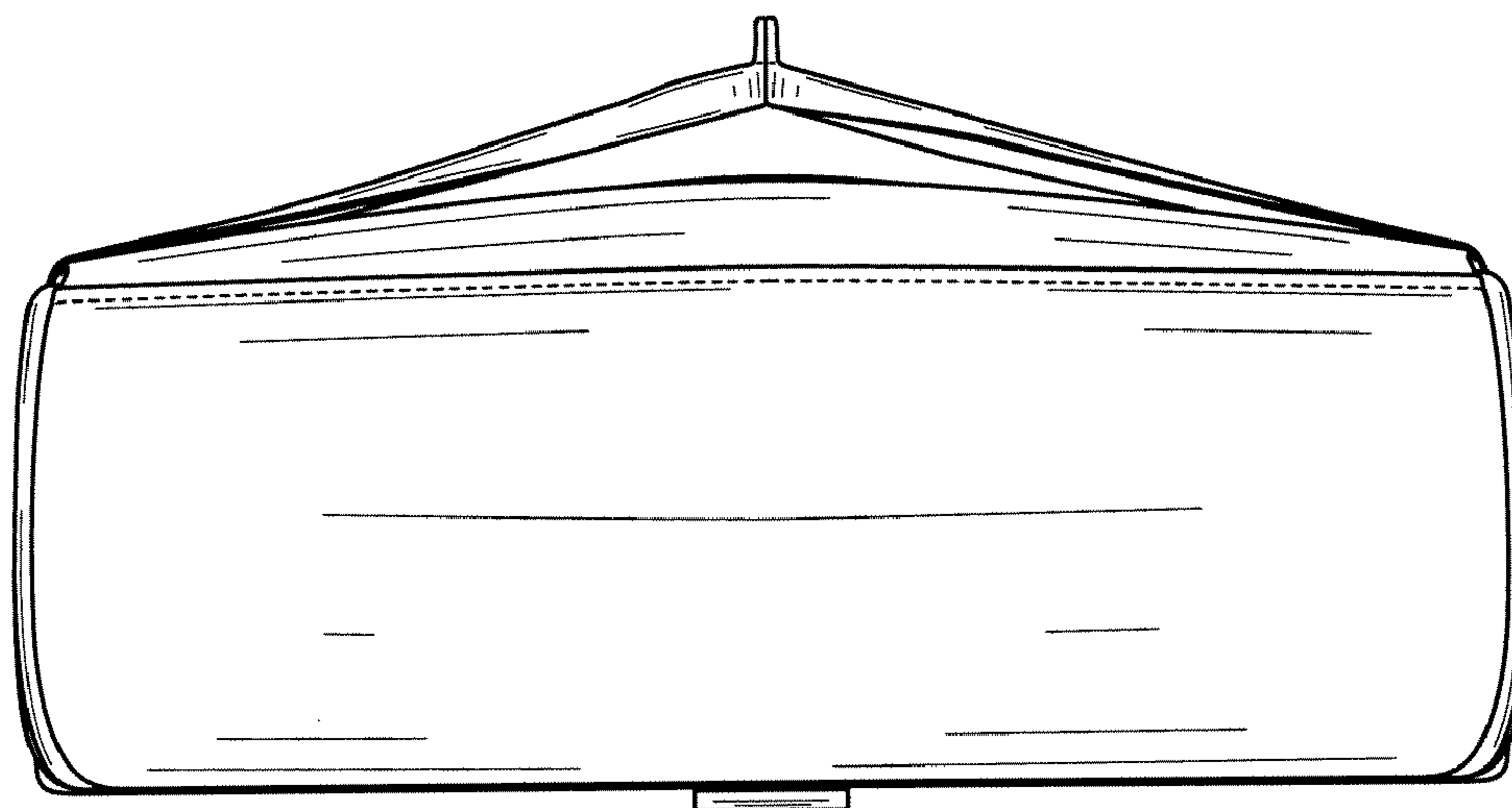

FIG. 10

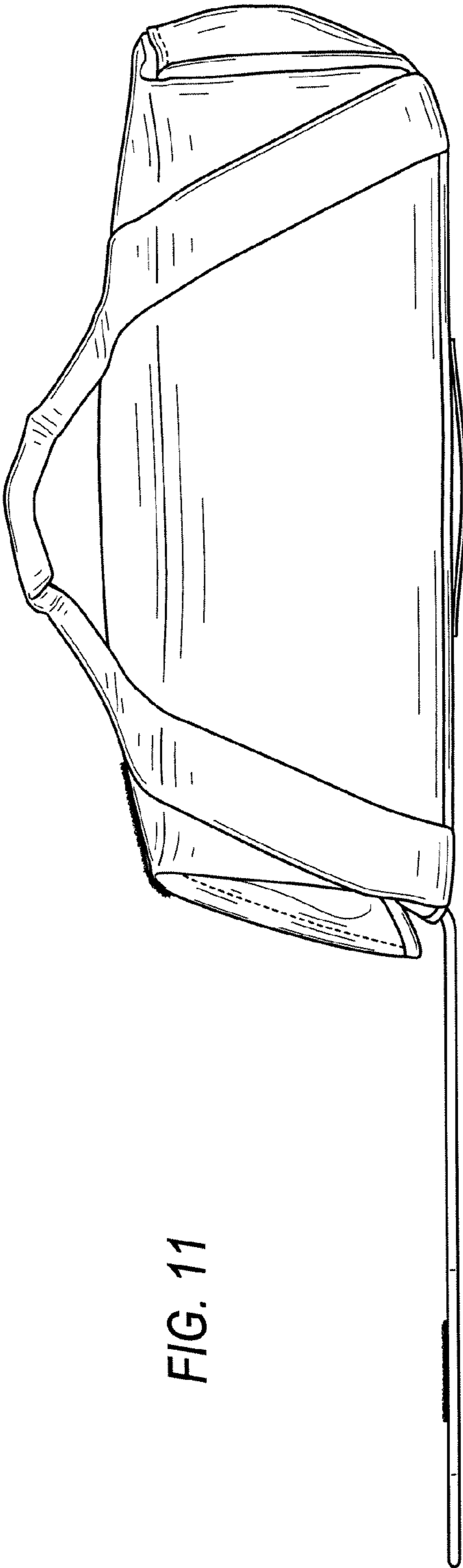

FIG. 11

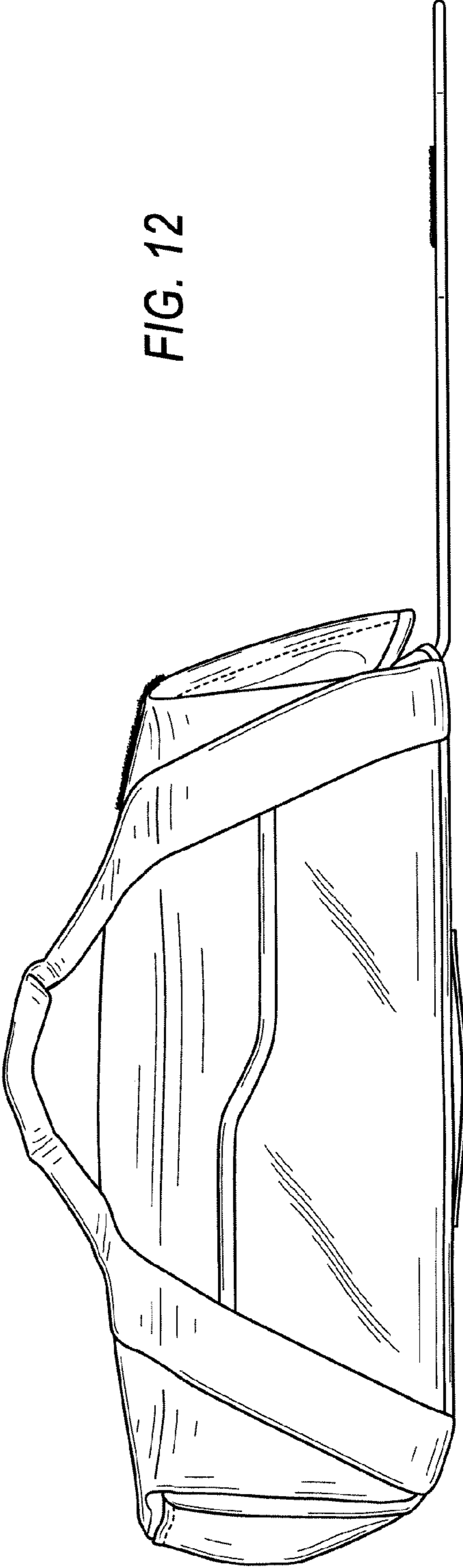

FIG. 12

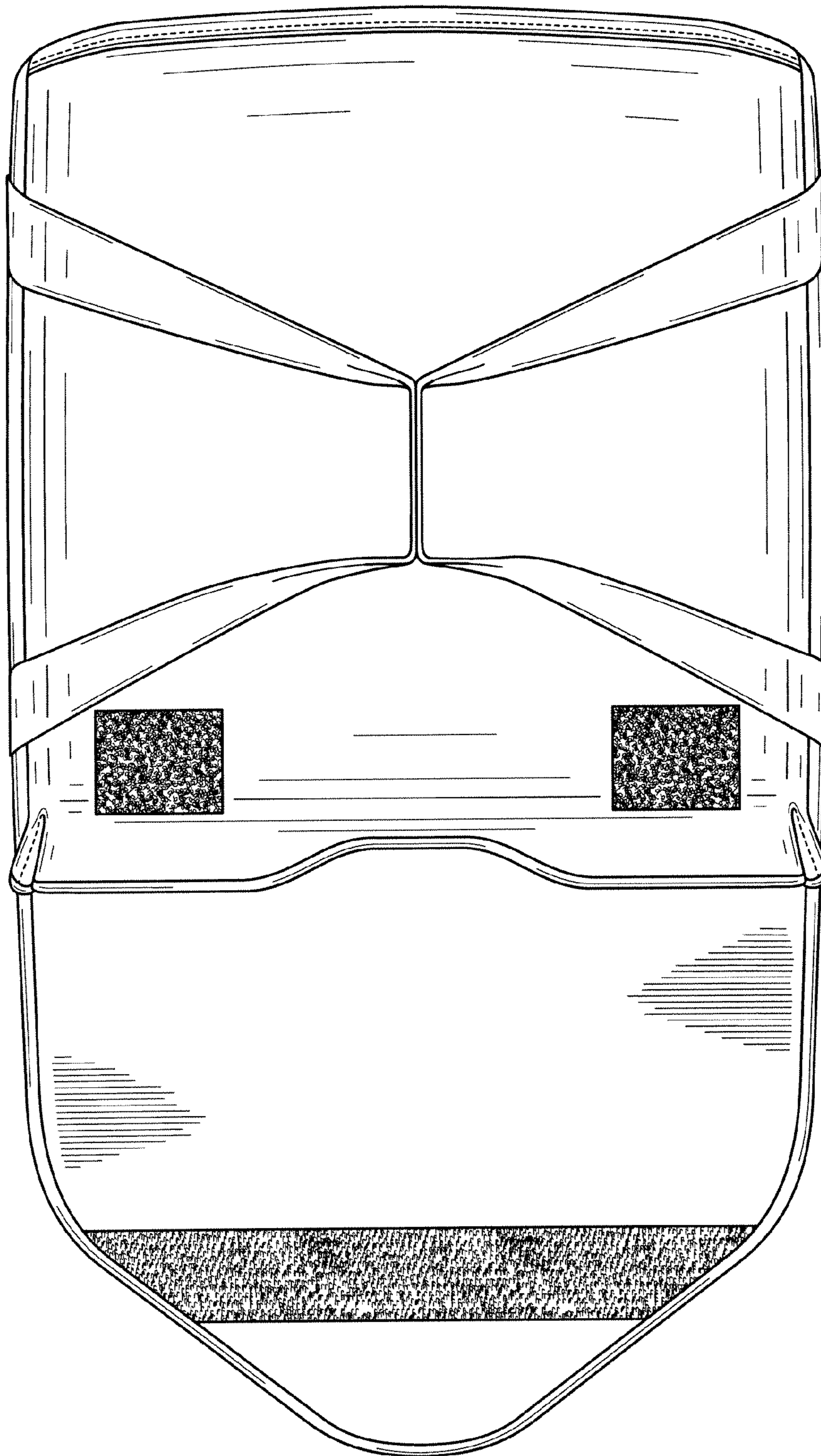

FIG. 13

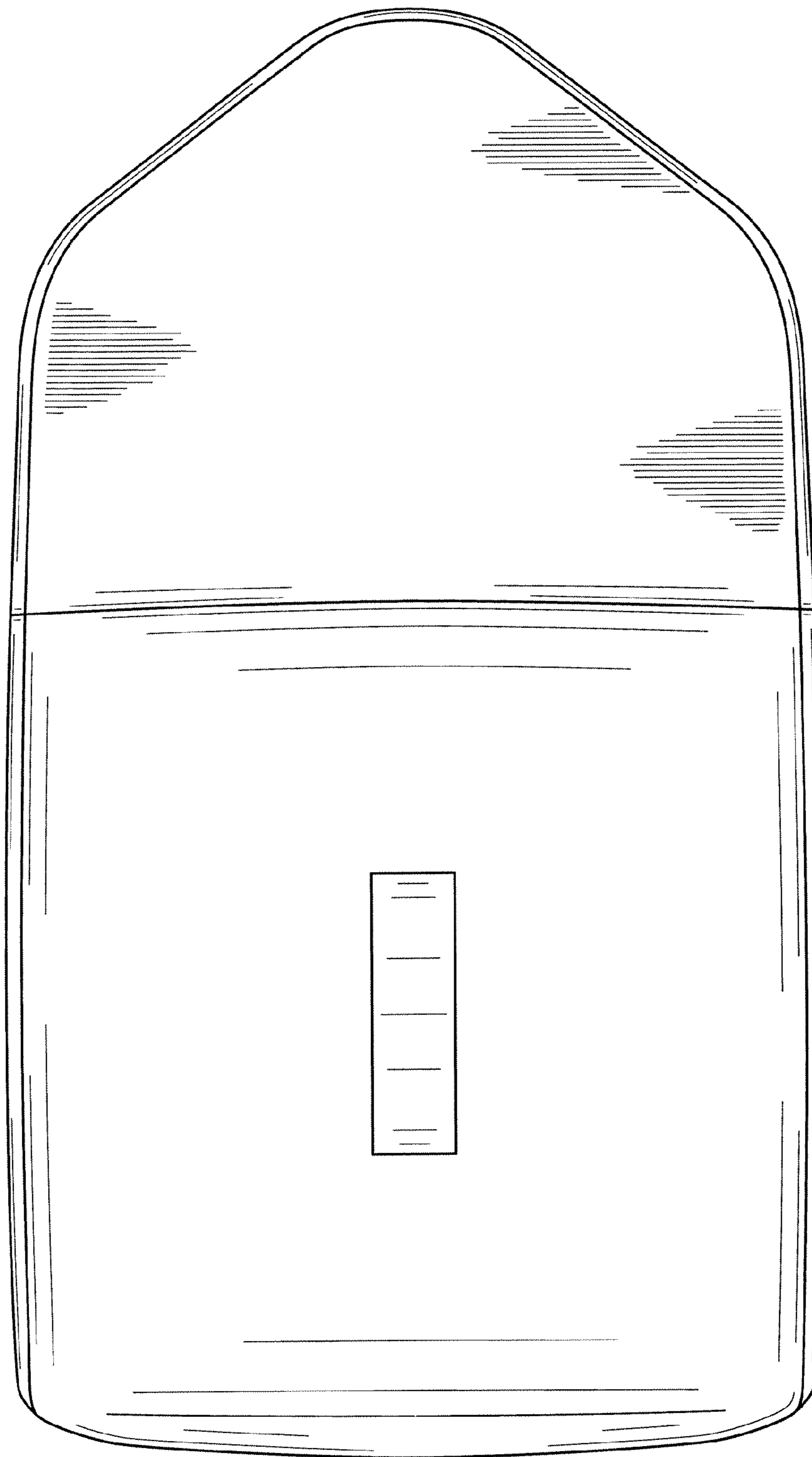

FIG. 14