



US00D674204S

(12) **United States Design Patent**
Rosa

(10) **Patent No.:** **US D674,204 S**
(45) **Date of Patent:** **** Jan. 15, 2013**

(54) **ARM-CHAIR**

(76) **Inventor:** **Carlo Leonardo Rosa, Turin (IT)**

(**) **Term:** **14 Years**

(21) **Appl. No.:** **29/399,178**

(22) **Filed:** **Aug. 10, 2011**

(51) **LOC (9) Cl.** **06-01**

(52) **U.S. Cl.** **D6/358**

(58) **Field of Classification Search** D6/334-336,
D6/358, 364, 365, 369, 371-374, 375, 381,
D6/500-502; 297/181, 249, 445.1, 446.1,
297/448.1, 448.2; D7/509, 533, 536
See application file for complete search history.

(56) **References Cited**

U.S. PATENT DOCUMENTS

| | | | | | | |
|-----------|---|---|---------|------------|-------|---------|
| 3,002,787 | A | * | 10/1961 | Ziegenfuss | | 297/249 |
| D220,481 | S | * | 4/1971 | Aarnio | | D6/365 |
| D245,953 | S | * | 10/1977 | Mathur | | D6/334 |
| D336,165 | S | * | 6/1993 | Tihany | | D6/334 |

| | | | | | | |
|----------|---|---|--------|----------|-------|--------|
| D517,370 | S | * | 3/2006 | Kingsley | | D7/536 |
| D560,971 | S | * | 2/2008 | Sung | | D7/536 |
| D612,622 | S | * | 3/2010 | Paulin | | D6/334 |
| D643,224 | S | * | 8/2011 | Sofield | | D6/334 |

* cited by examiner

Primary Examiner — Mimoso De

(74) *Attorney, Agent, or Firm* — Heslin Rothenberg Farley & Mesiti P.C.; Victor A. Cardona, Esq.

(57) **CLAIM**

The design for the arm-chair, as shown and described.

DESCRIPTION

FIG. 1 is a top plan view comprising the new design;
FIG. 2 is a bottom view thereof;
FIG. 3 is a front view thereof;
FIG. 4 is a right side view thereof, where the left side view is a mirror image thereof;
FIG. 5 is a rear view thereof; and,
FIG. 6 is a perspective view thereof.

1 Claim, 3 Drawing Sheets

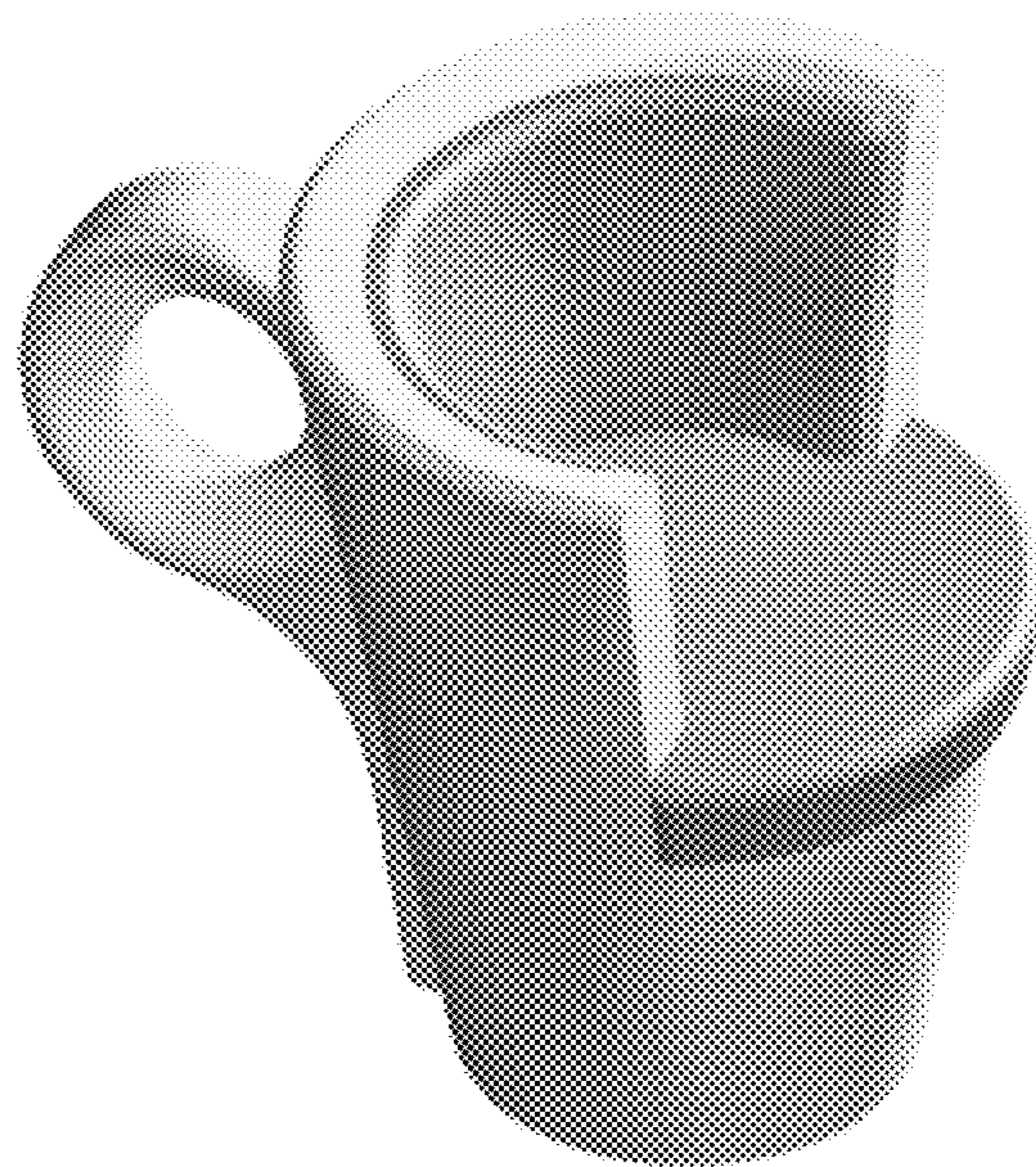
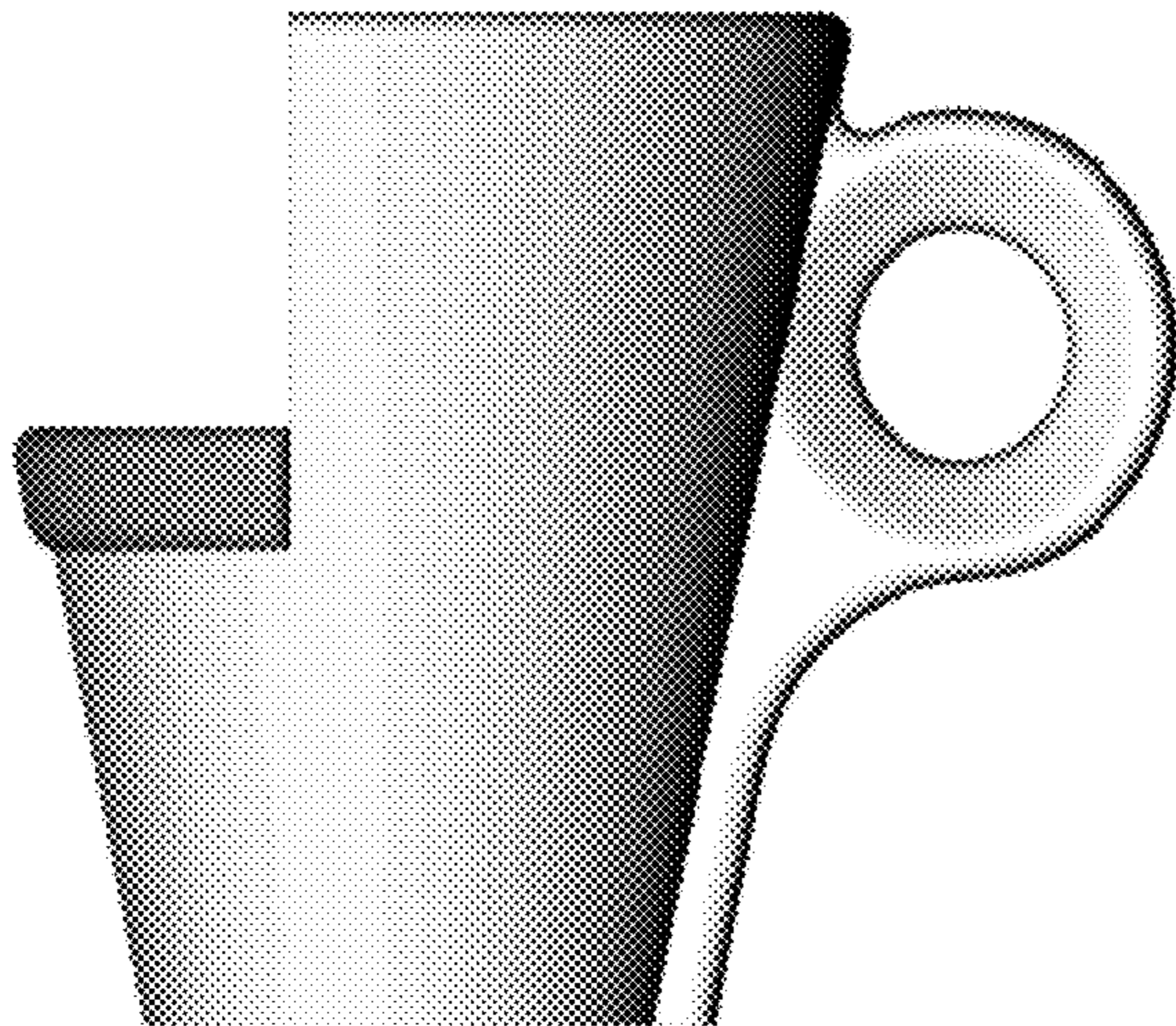

FIG. 2

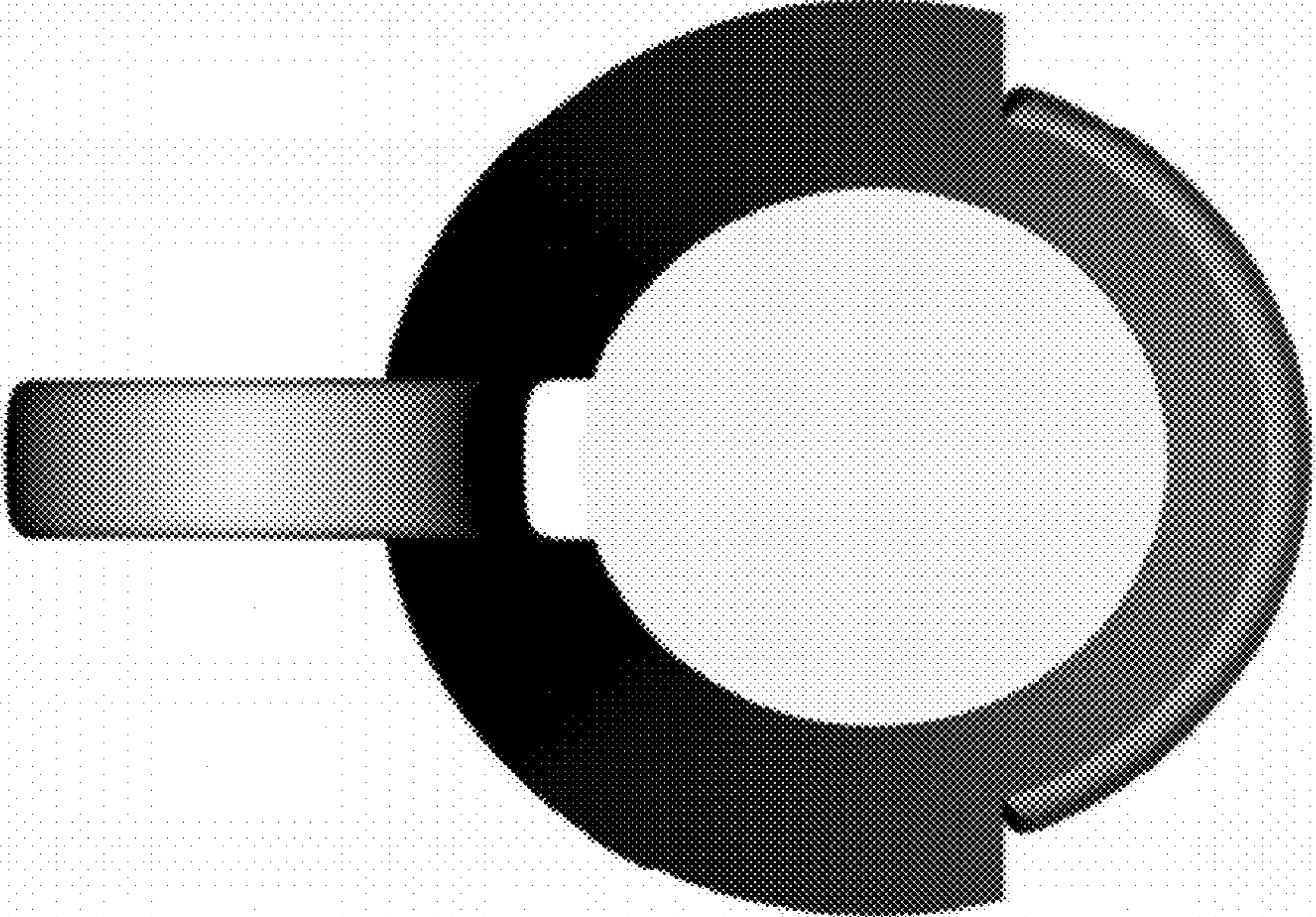

FIG. 1

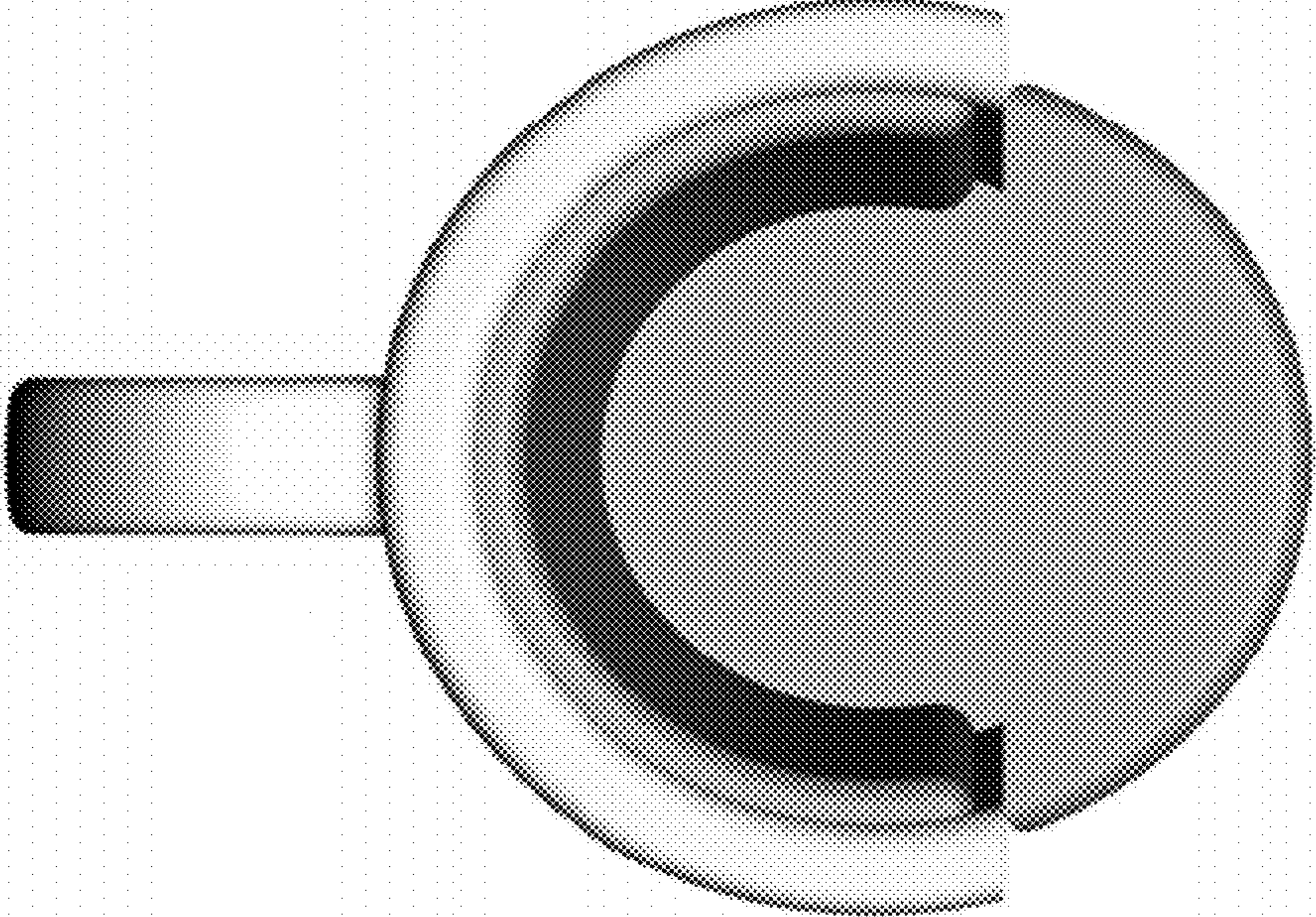

FIG. 4

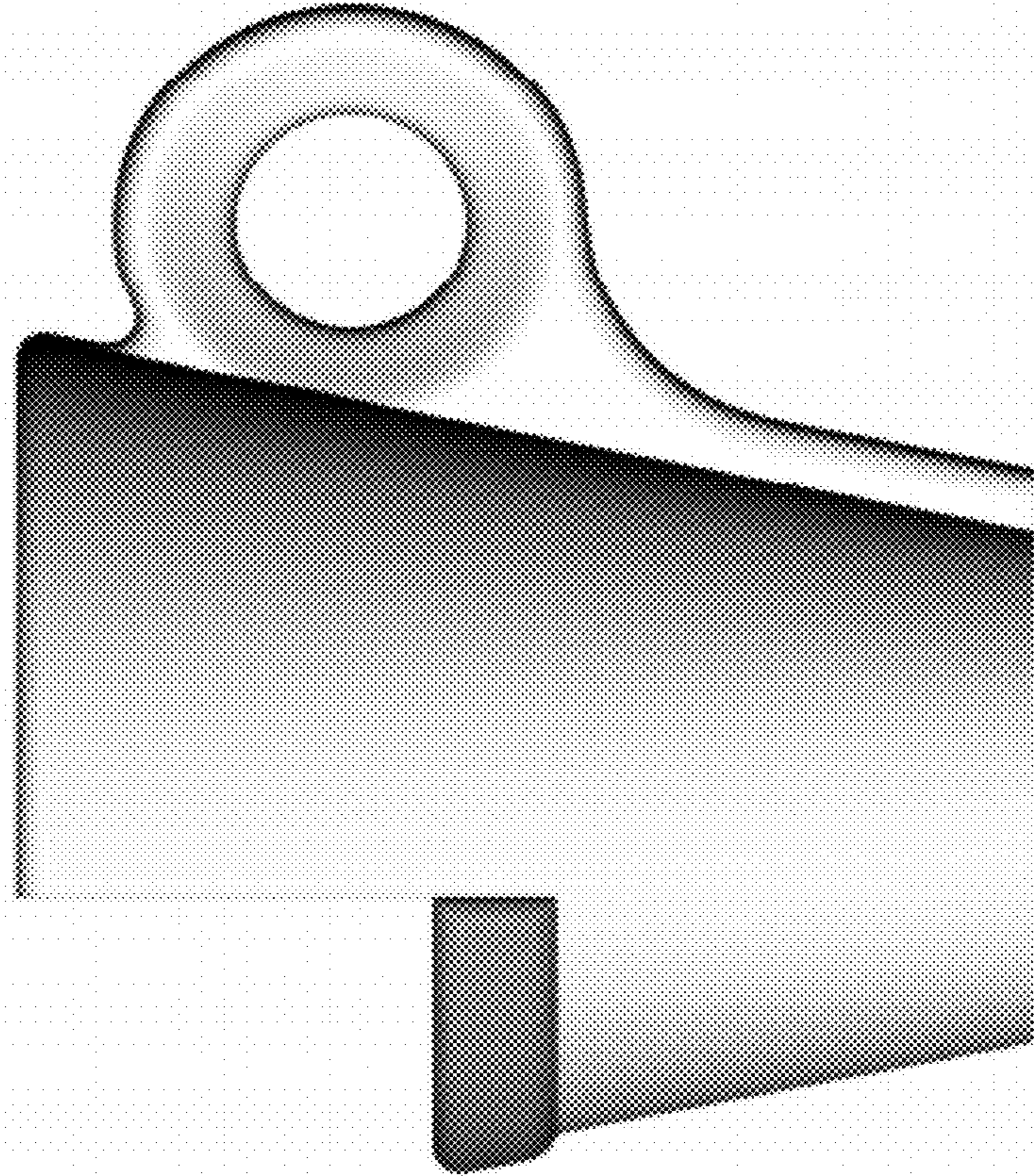

FIG. 3

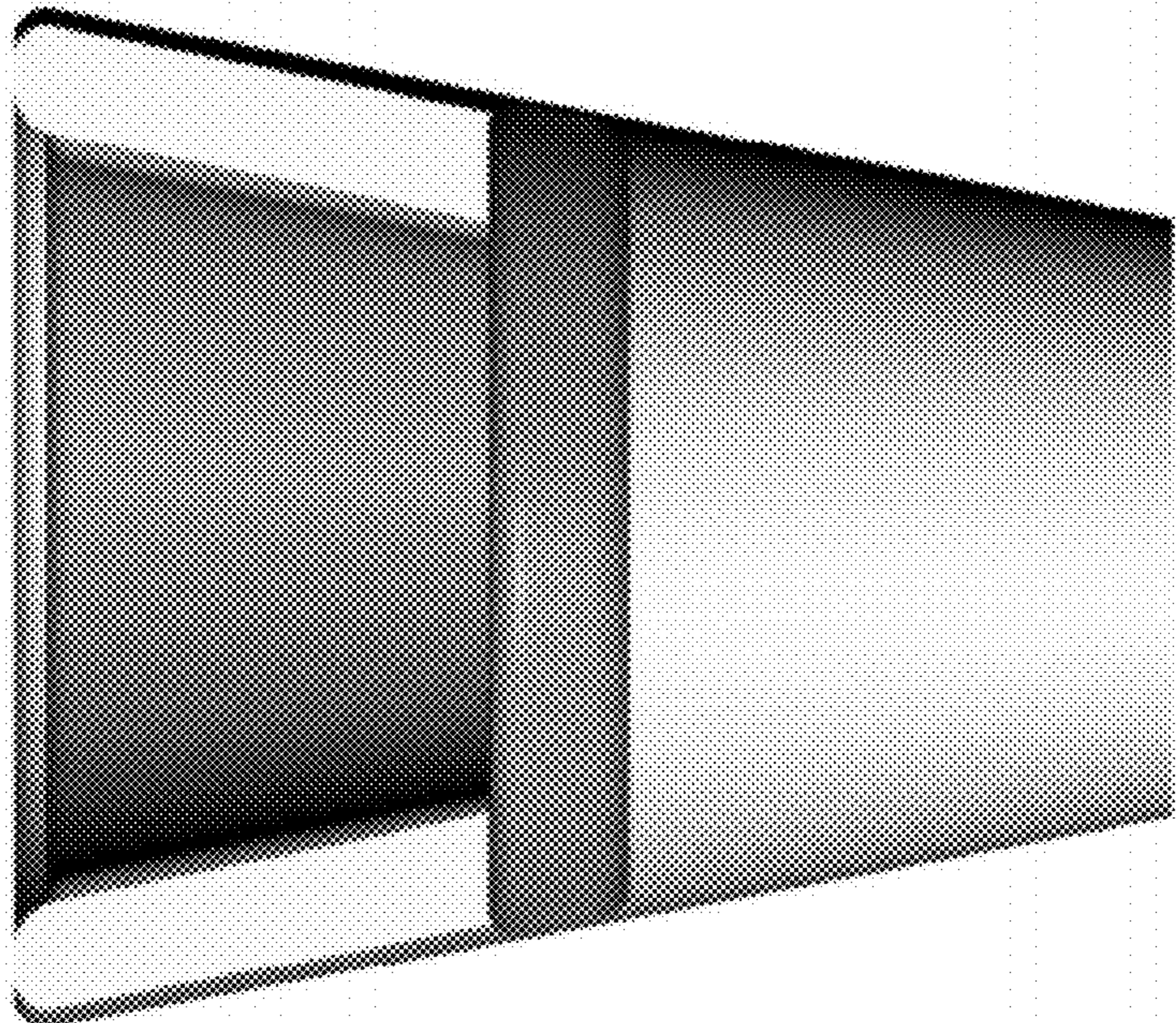

FIG. 6

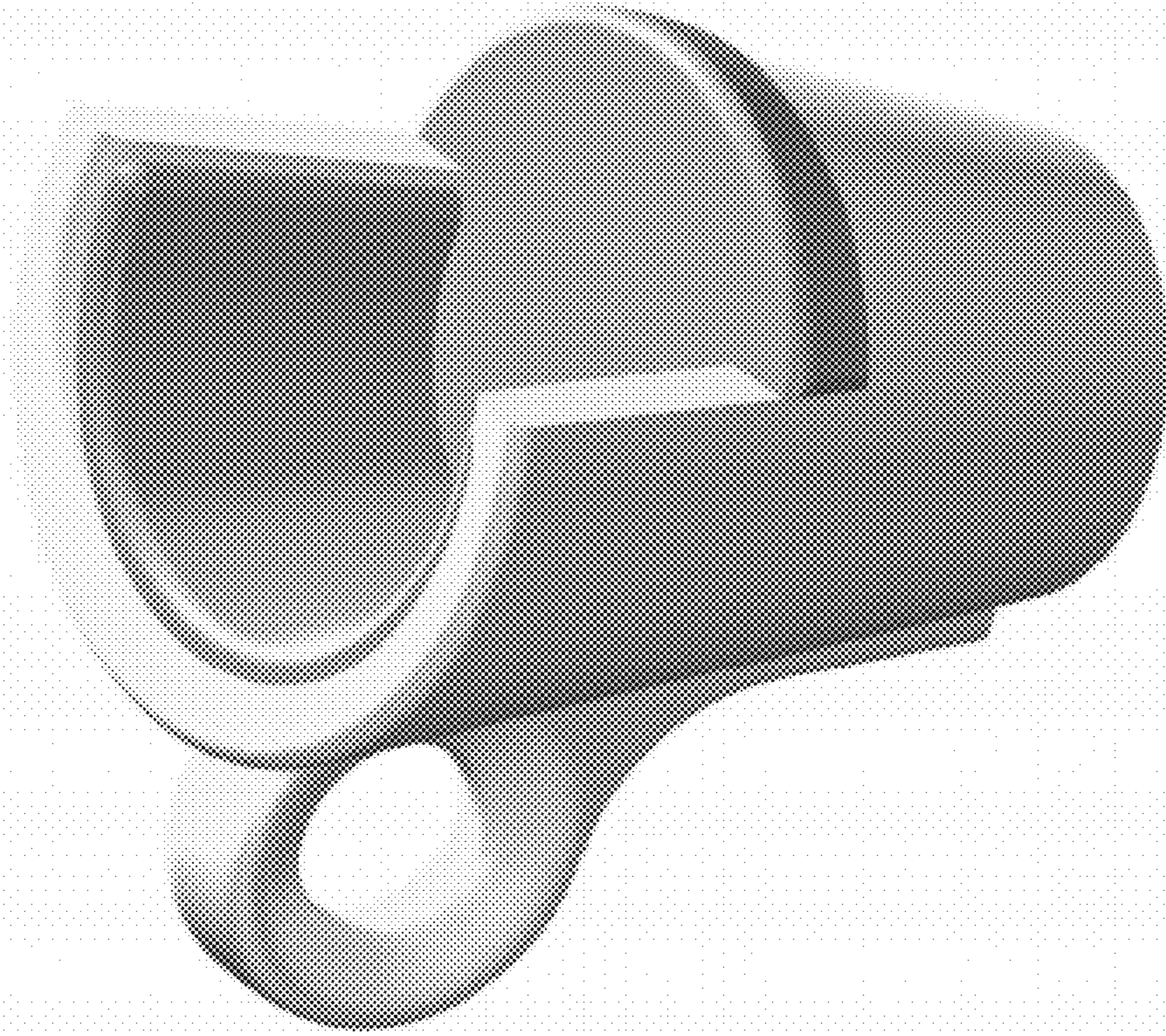

FIG. 5

