



US00D674181S

(12) **United States Design Patent**  
**Faulkner et al.**

(10) **Patent No.:** **US D674,181 S**  
(45) **Date of Patent:** **\*\* Jan. 15, 2013**

(54) **MEDICAL DEVICE CASE**

(75) Inventors: **Allan Faulkner**, Avoch (GB); **Nick Foley**, Edinburgh (GB); **Jonny Nelson**, Inverness (GB); **Simon Salter**, Edinburgh (GB); **Paul Trickett**, Hamilton (GB)

(73) Assignee: **LifeScan Scotland Limited**, Inverness (GB)

(\*\*) Term: **14 Years**

(21) Appl. No.: **29/414,768**

(22) Filed: **Mar. 2, 2012**

(51) **LOC (9) Cl.** ..... **03-01**

(52) **U.S. Cl.** ..... **D3/203.1; D24/294**

(58) **Field of Classification Search** ..... D3/201,  
D3/203.1–203.8, 205, 263–26; 206/5, 5.1,  
206/6, 528–540; 248/902, 316.4

See application file for complete search history.

(56) **References Cited**

U.S. PATENT DOCUMENTS

586,816	A	*	7/1897	Hammer	.....	206/6
2,184,408	A	*	12/1939	Bouchard	.....	206/6
D417,541	S	*	12/1999	Conway	.....	D3/263
D496,784	S	*	10/2004	Mandel	.....	D3/203.1
D528,299	S	*	9/2006	Kim	.....	D3/294

D586,557	S	*	2/2009	Jalet	.....	D3/294
D650,986	S	*	12/2011	Brady et al.	.....	D3/203.1
D663,943	S	*	7/2012	Walsh et al.	.....	D3/203.1

\* cited by examiner

*Primary Examiner* — Catheri Oliver-Garcia

(57) **CLAIM**

We claim the ornamental design for a medical device case, as shown and described.

**DESCRIPTION**

FIG. 1 is an lower left front perspective view of the medical device case in the closed condition.

FIG. 2 is a top plan view of the medical device case in the closed condition.

FIG. 3 is a front view of the medical device case in the closed condition.

FIG. 4 is a bottom plan view of the medical device case in the closed condition.

FIG. 5 is a rear view of the medical device case in the closed condition.

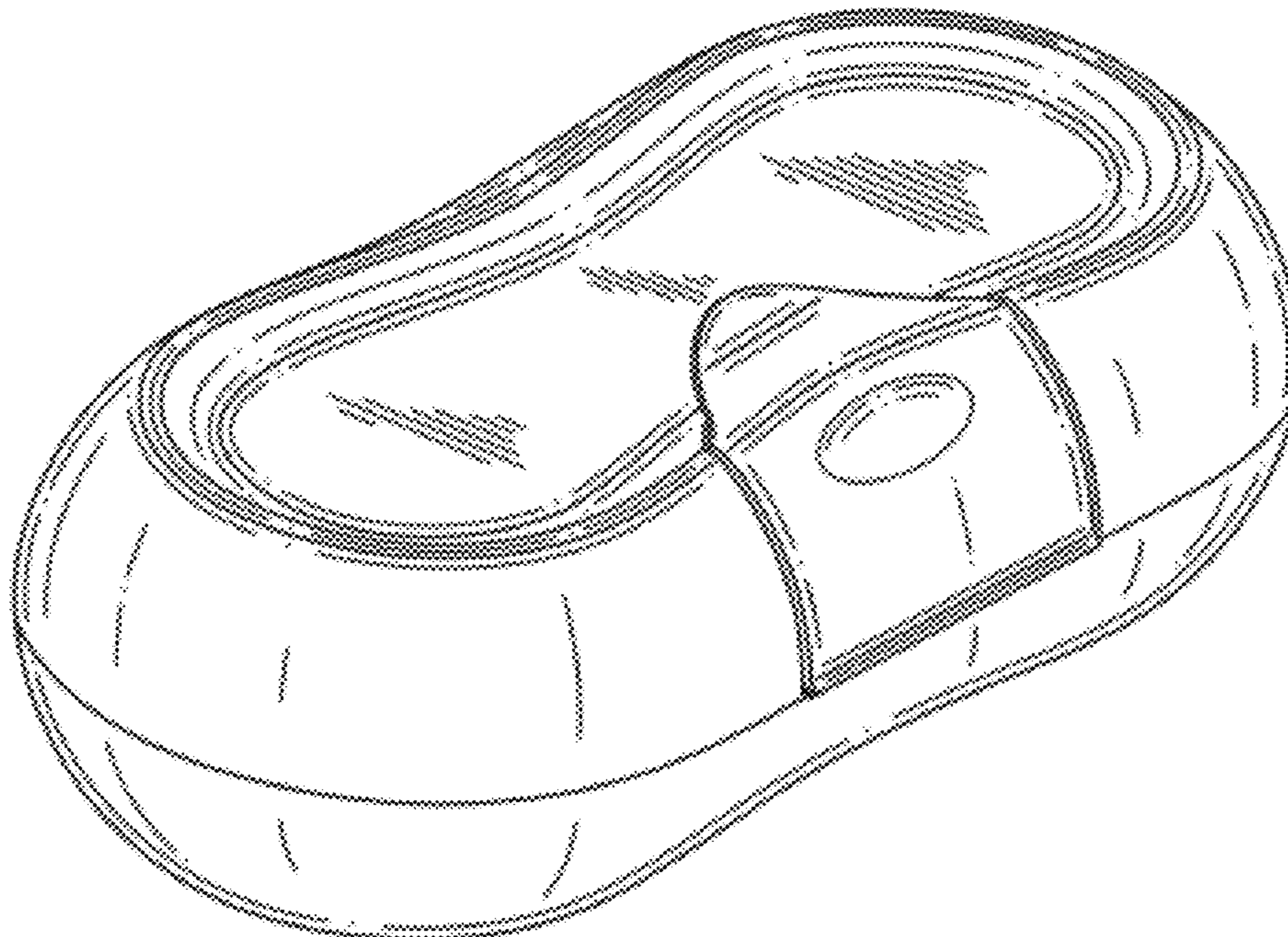
FIG. 6 is a left side view of the medical device case in the closed condition.

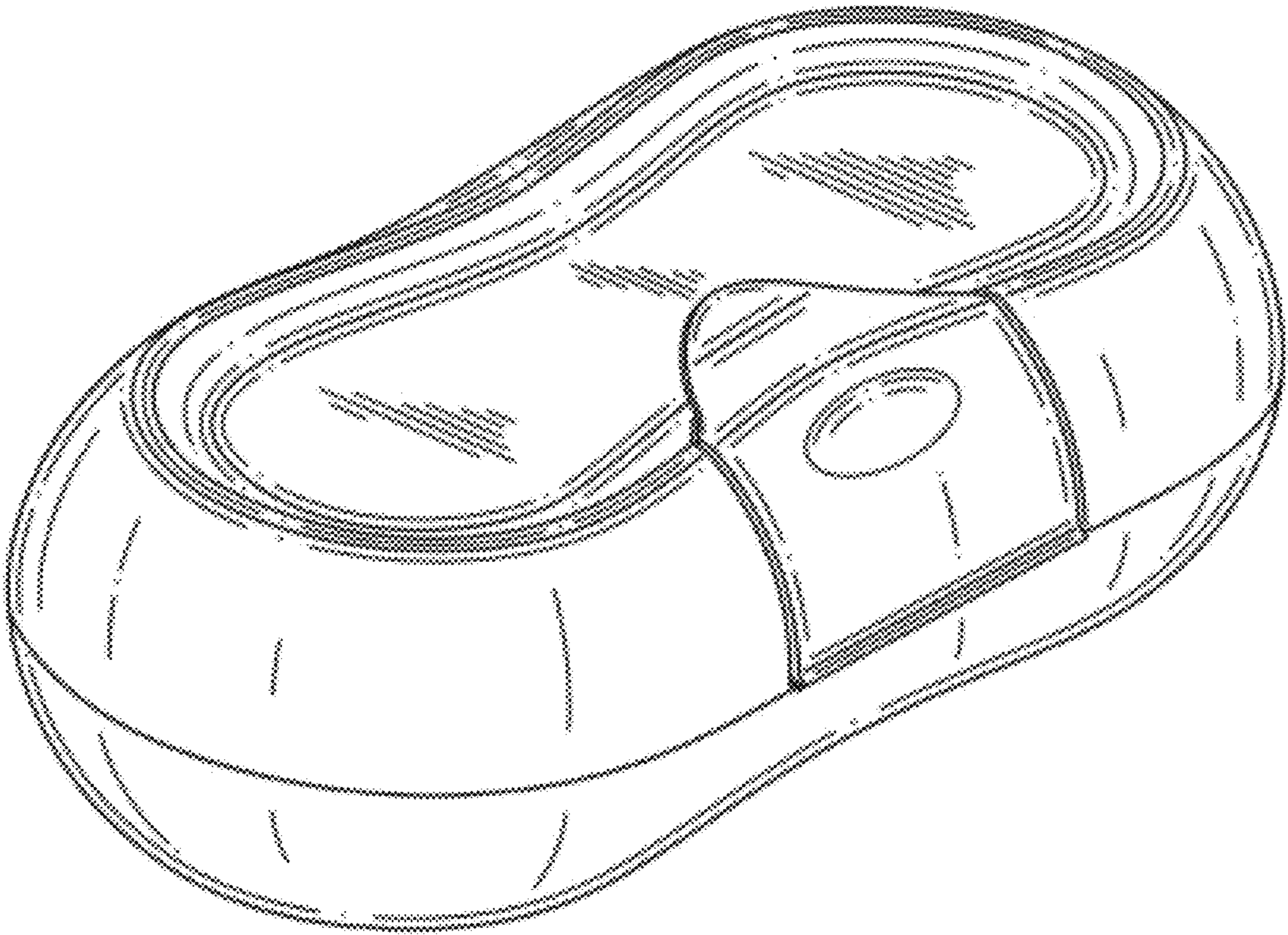
FIG. 7 is a right side view of the medical device case in the closed condition.

FIG. 8 is an upper left perspective view of medical device case in the opened condition; and,

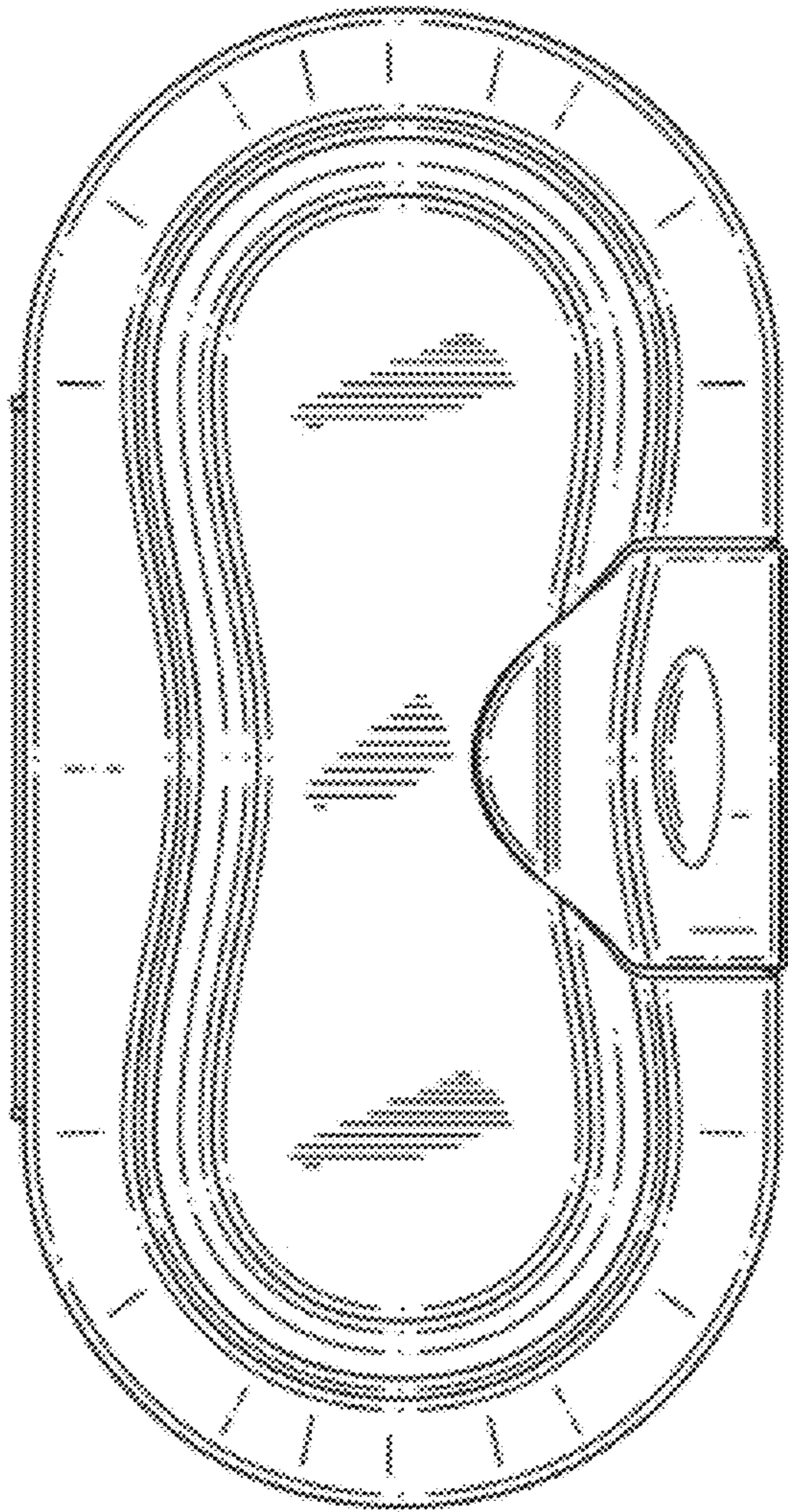
FIG. 9 is a bottom left perspective view of medical device case in the opened condition.

**1 Claim, 6 Drawing Sheets**

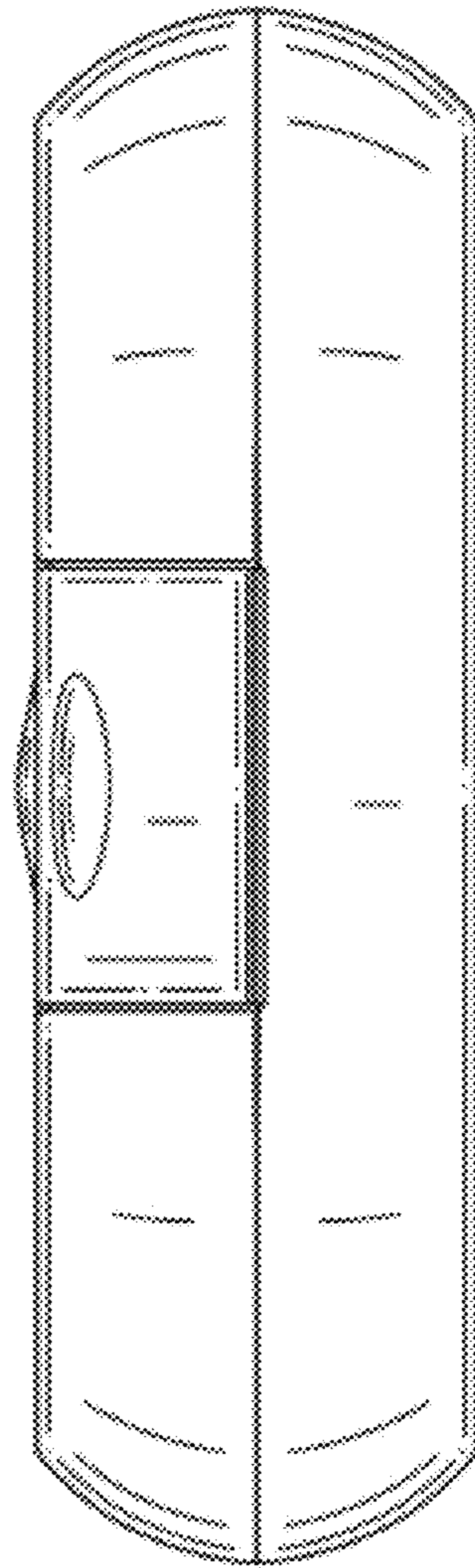




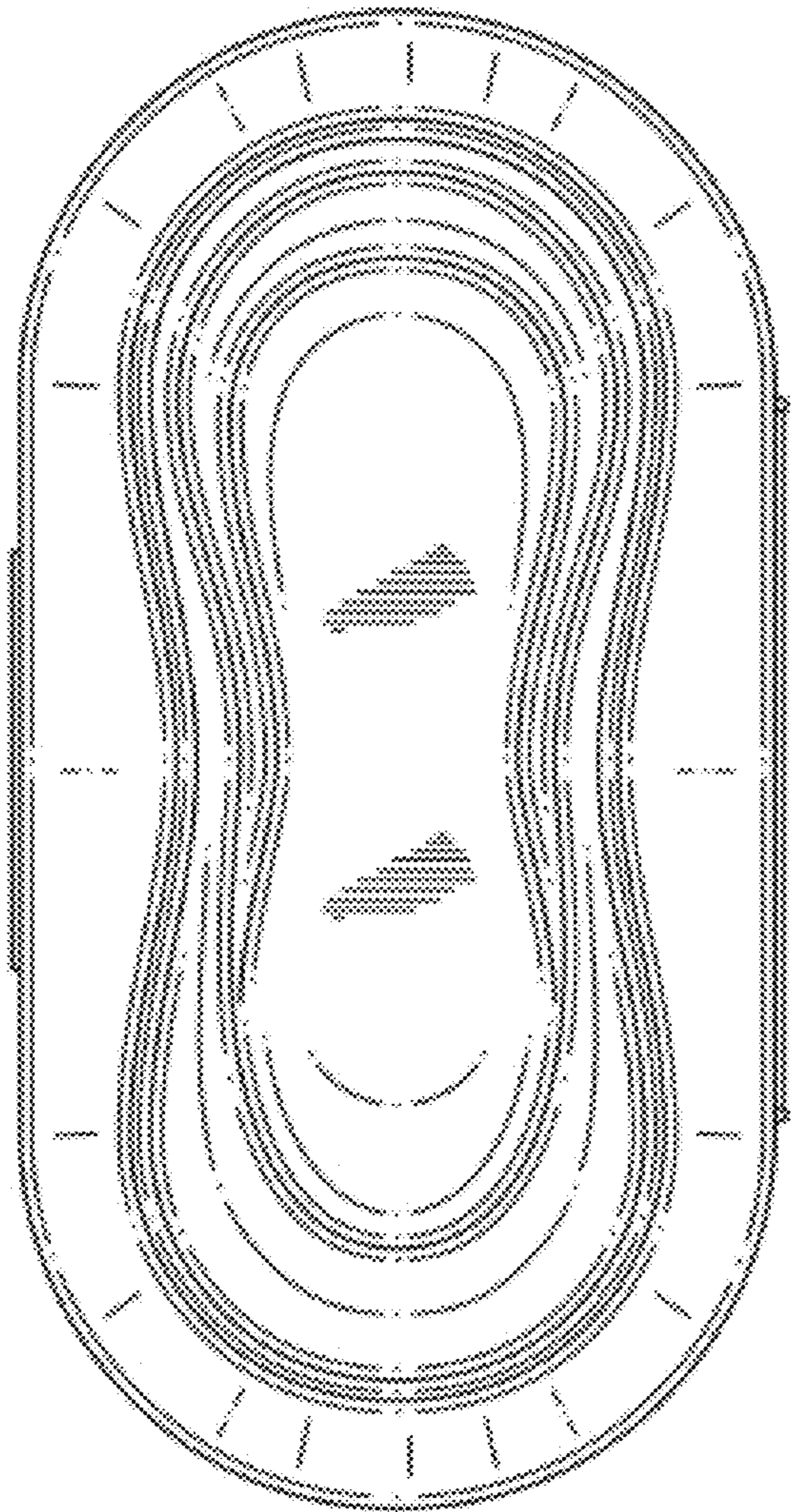
**FIG. 1**



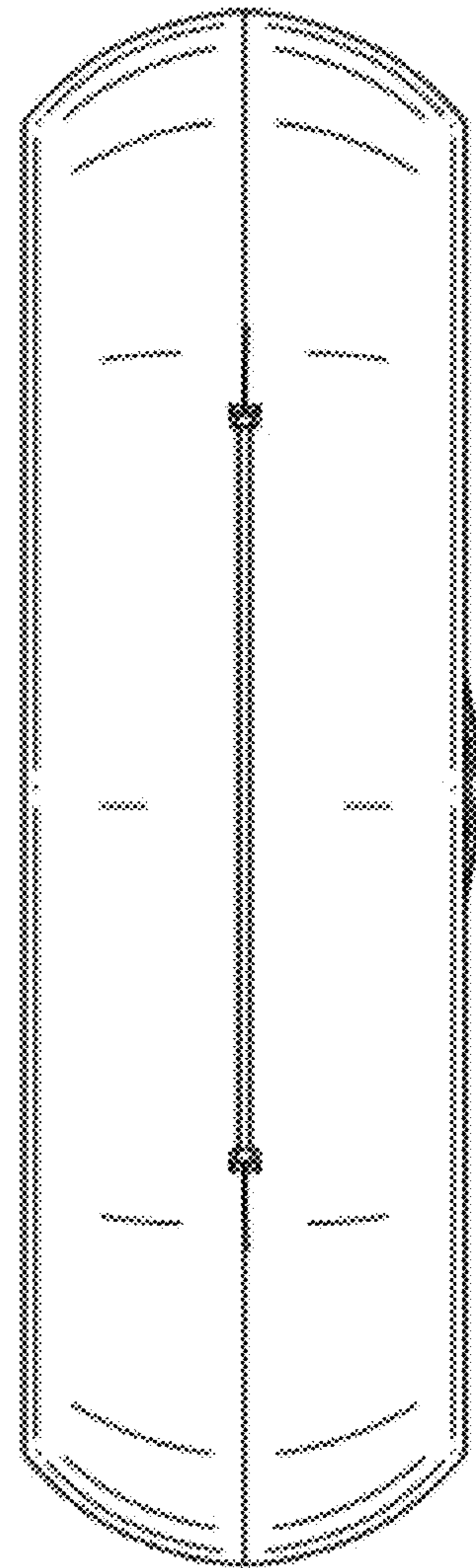
**FIG. 2**



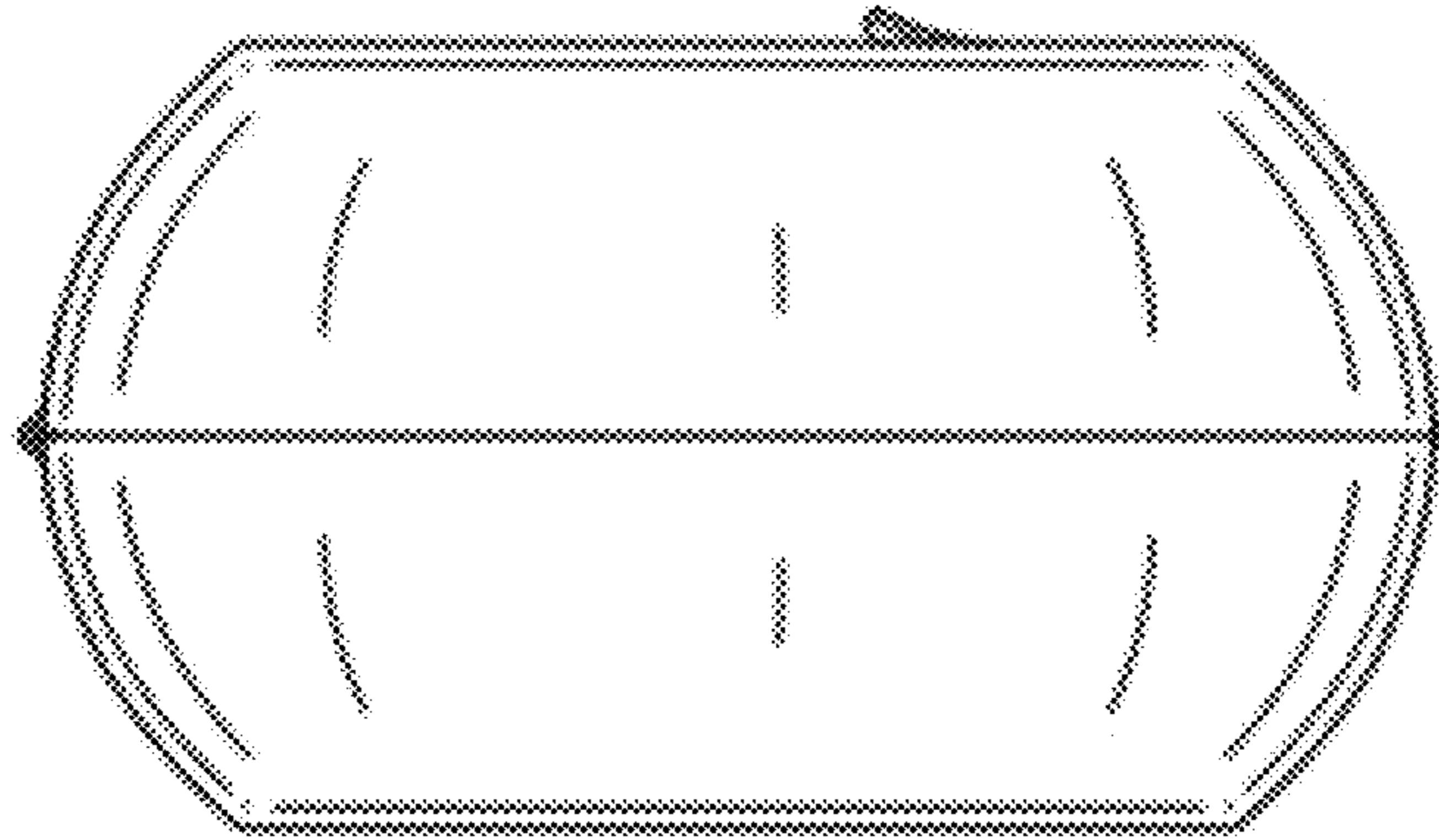
**FIG. 3**



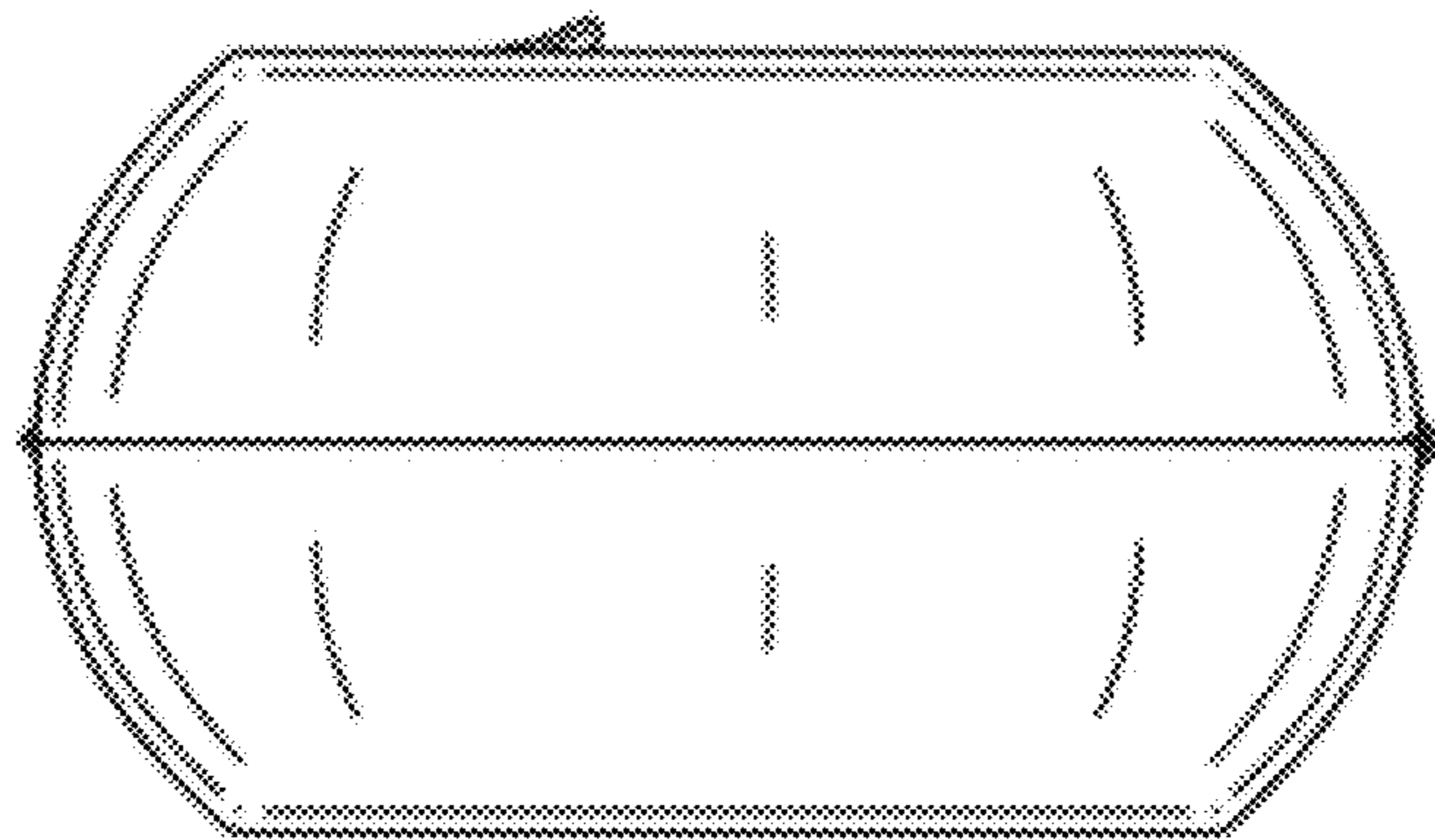
**FIG. 4**



**FIG. 5**



**FIG. 6**



**FIG. 7**

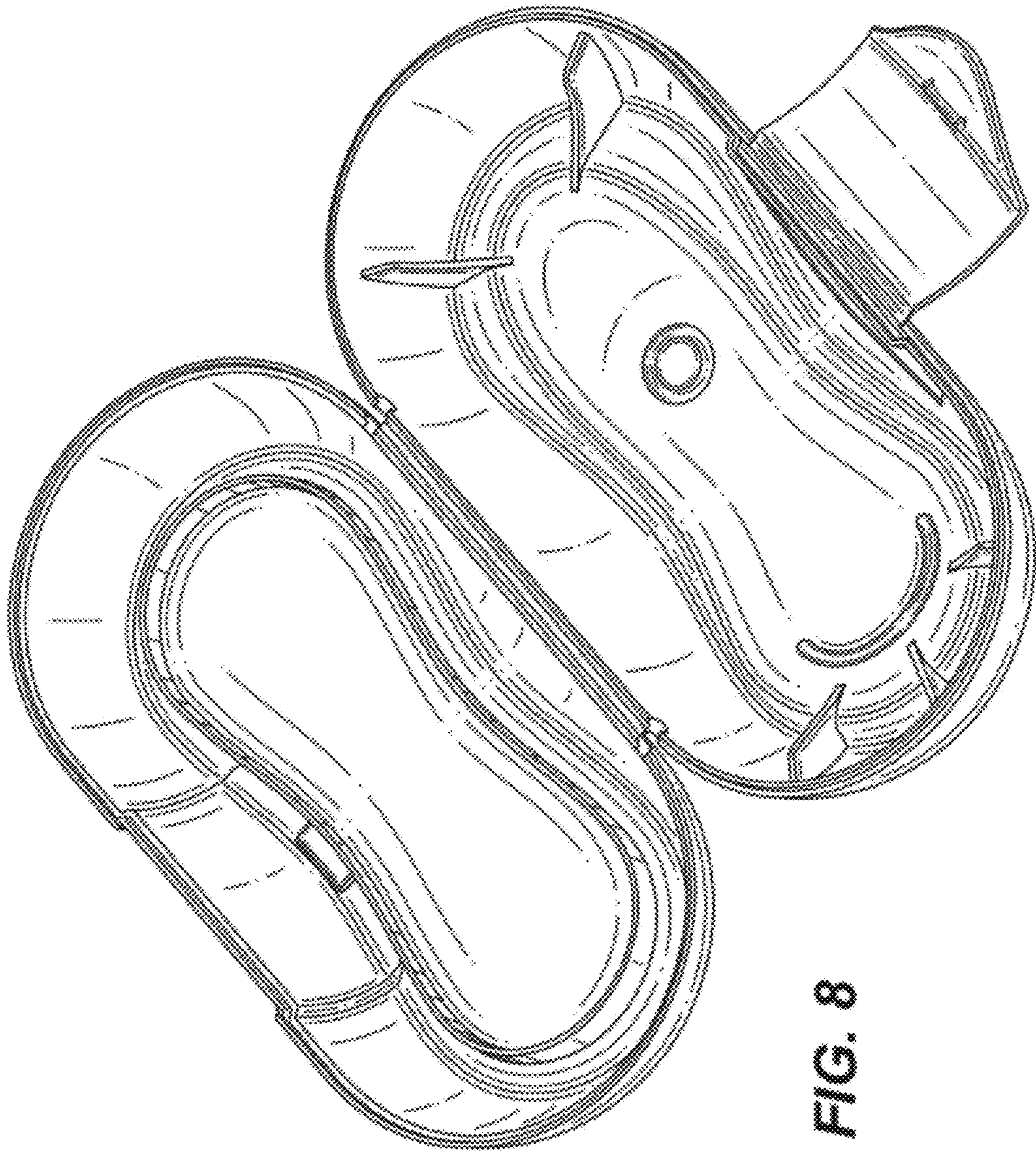


FIG. 8

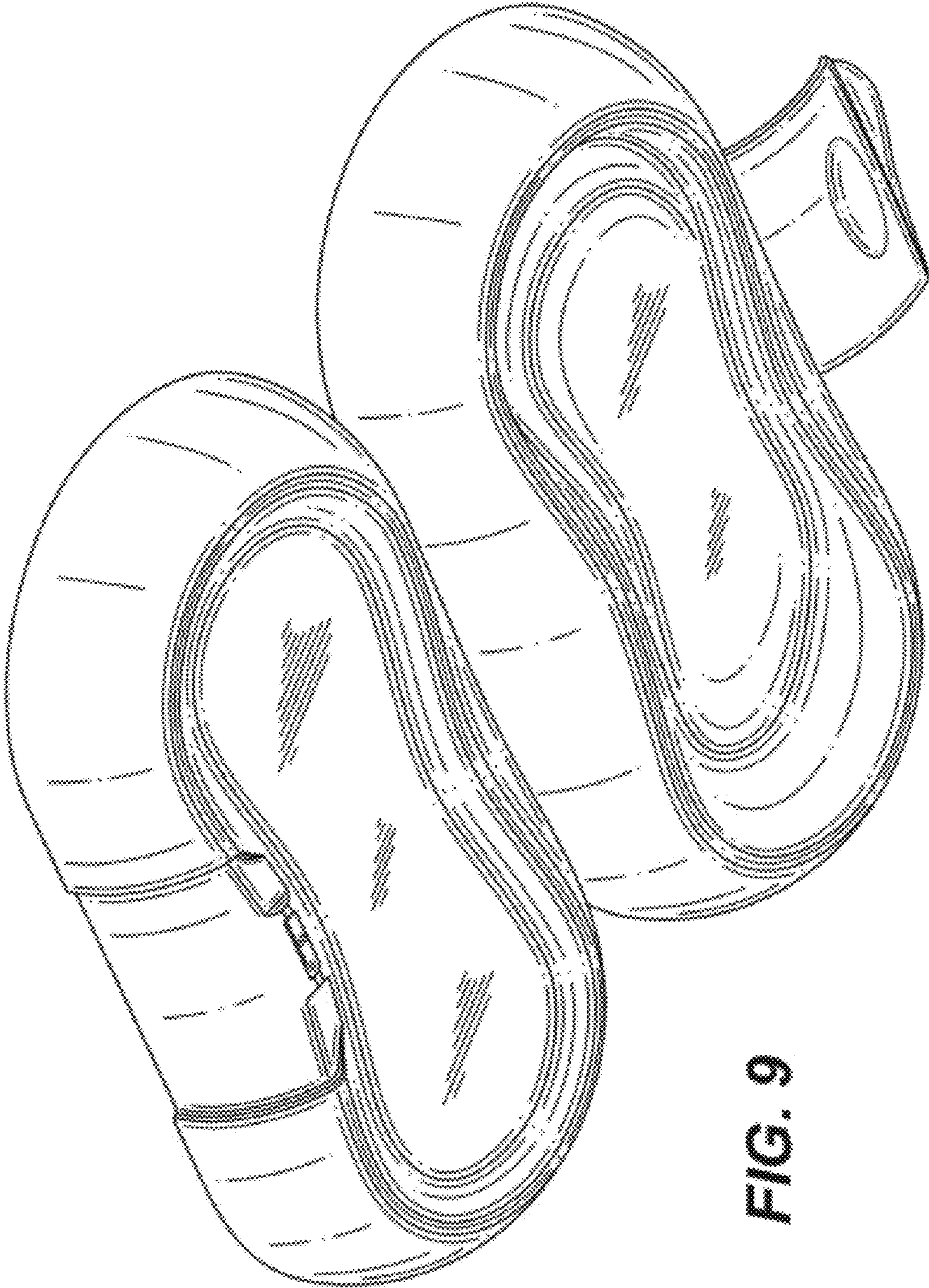


FIG. 9