



US00D674166S

(12) **United States Design Patent**
Wilson

(10) **Patent No.:** **US D674,166 S**
(45) **Date of Patent:** **** Jan. 15, 2013**

(54) **SHORTS**

(75) Inventor: **Ron Wilson**, Solana Beach, CA (US)

(73) Assignee: **Power & Honor, LLC**, Deerfield Beach, FL (US)

(**) Term: **14 Years**

(21) Appl. No.: **29/395,964**

(22) Filed: **Apr. 27, 2012**

Related U.S. Application Data

(63) Continuation of application No. 29/395,169, filed on Dec. 8, 2011, now Pat. No. Des. 661,464, which is a continuation-in-part of application No. 29/333,871, filed on Mar. 16, 2009, now Pat. No. Des. 652,199, and a continuation-in-part of application No. 12/405,188, filed on Mar. 16, 2009, now Pat. No. 8,122,520.

(51) **LOC (9) Cl.** **02-02**

(52) **U.S. Cl.** **D2/738**

(58) **Field of Classification Search** D2/731, D2/738, 742, 712; 2/79, 80, 227, 228, 234-238
See application file for complete search history.

(56) **References Cited**

U.S. PATENT DOCUMENTS

D86,114 S * 2/1932 Dwyer D2/738
1,999,078 A * 4/1935 Best et al. 2/237
2,544,333 A * 3/1951 Lembo 2/221
D181,134 S * 10/1957 Lembo D2/712
D404,185 S * 1/1999 Lanter et al. D2/738

7,523,508 B2 * 4/2009 Contant et al. 2/227
D597,281 S * 8/2009 Young D2/738
D661,464 S * 6/2012 Wilson D2/738
2006/0021116 A1 * 2/2006 Protting 2/404

FOREIGN PATENT DOCUMENTS

JP 2006328601 A * 12/2006

OTHER PUBLICATIONS

MMA Gear Guide. <http://www.mmagearguide.com/jaco-uk-mma-shorts/>. Jan. 2010. Jaco UK MMA Shorts.*

* cited by examiner

Primary Examiner — Rashida Johnson

(74) *Attorney, Agent, or Firm* — Dan DeLaRosa

(57) **CLAIM**

The ornamental design for shorts, as shown and described.

DESCRIPTION

FIG. 1 is a front perspective view of the shorts of the present invention showing my new design;

FIG. 2 is a front elevational view thereof;

FIG. 3 is a back elevational view thereof;

FIG. 4 is side elevational view thereof;

FIG. 5 is another side elevational view thereof;

FIG. 6 is a top plan view thereof; and,

FIG. 7 is a bottom plan view thereof.

The broken lines in FIGS. 1-7, on the surface of the shorts, represent stitching. The remaining broken lines, encircling the waist and leg openings in FIGS. 1 and 4-7, and showing a rear, extended, central waistband tab in FIGS. 1-6, represent the portions of the shorts, which form no part of the claimed design.

1 Claim, 7 Drawing Sheets

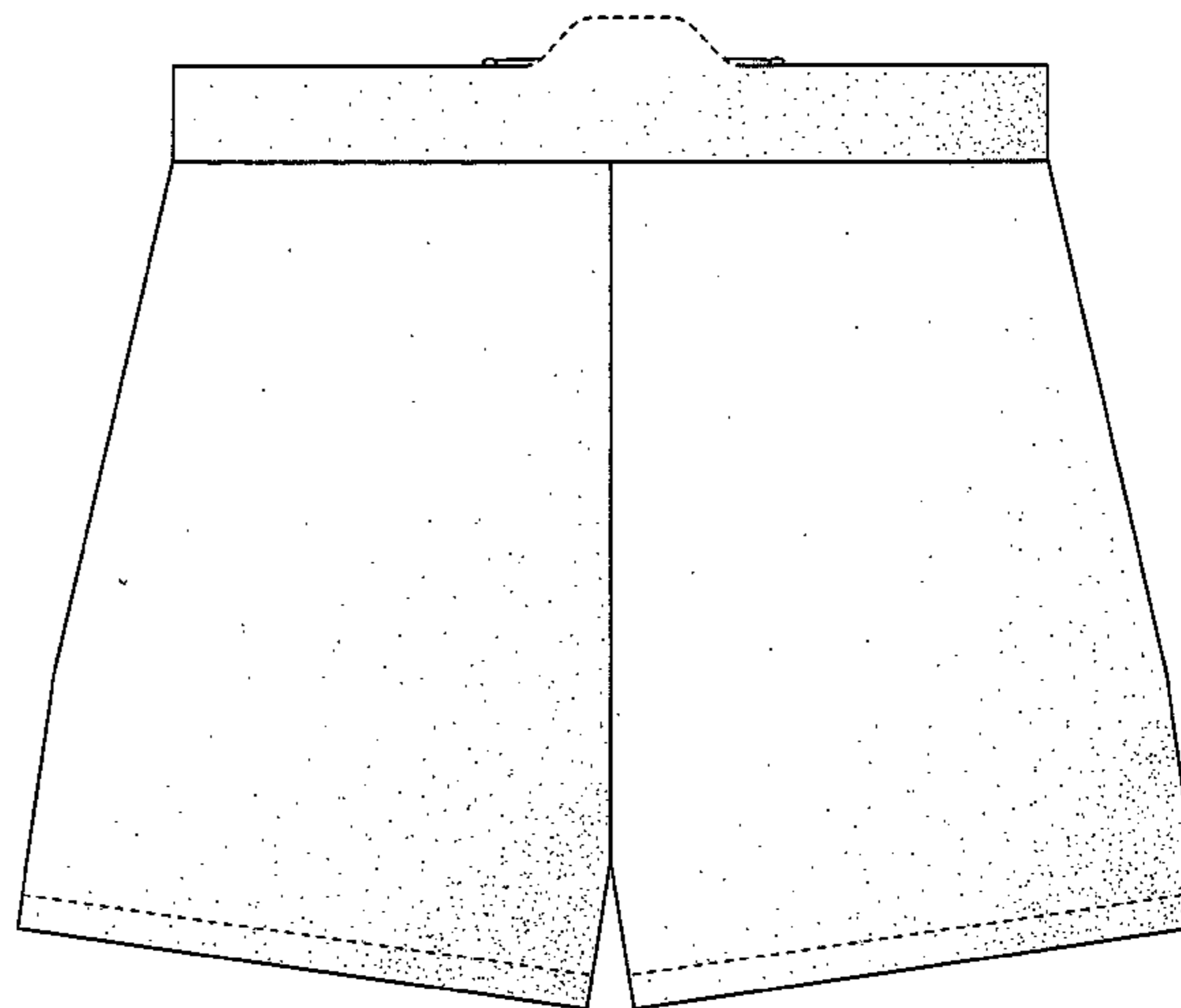
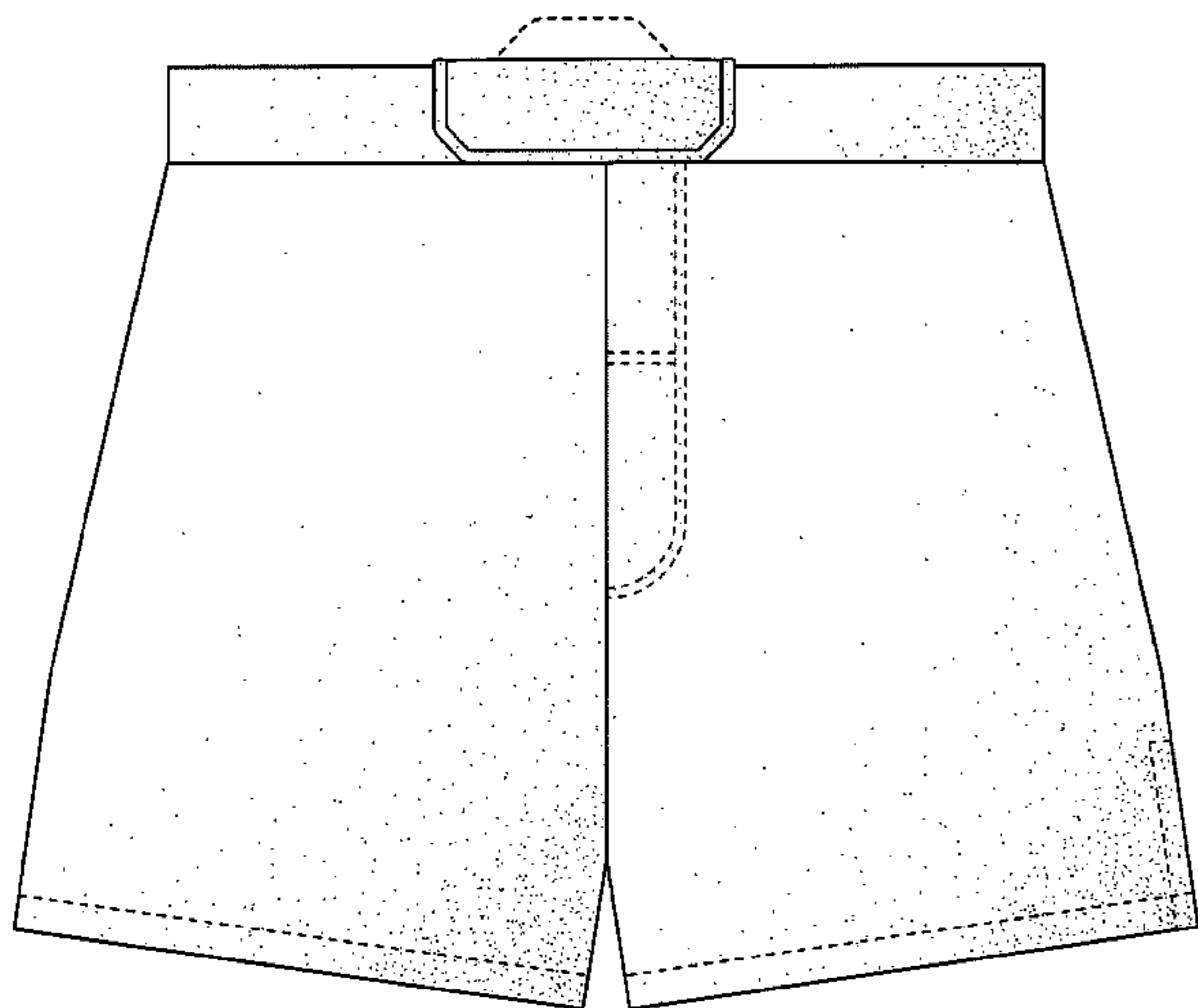

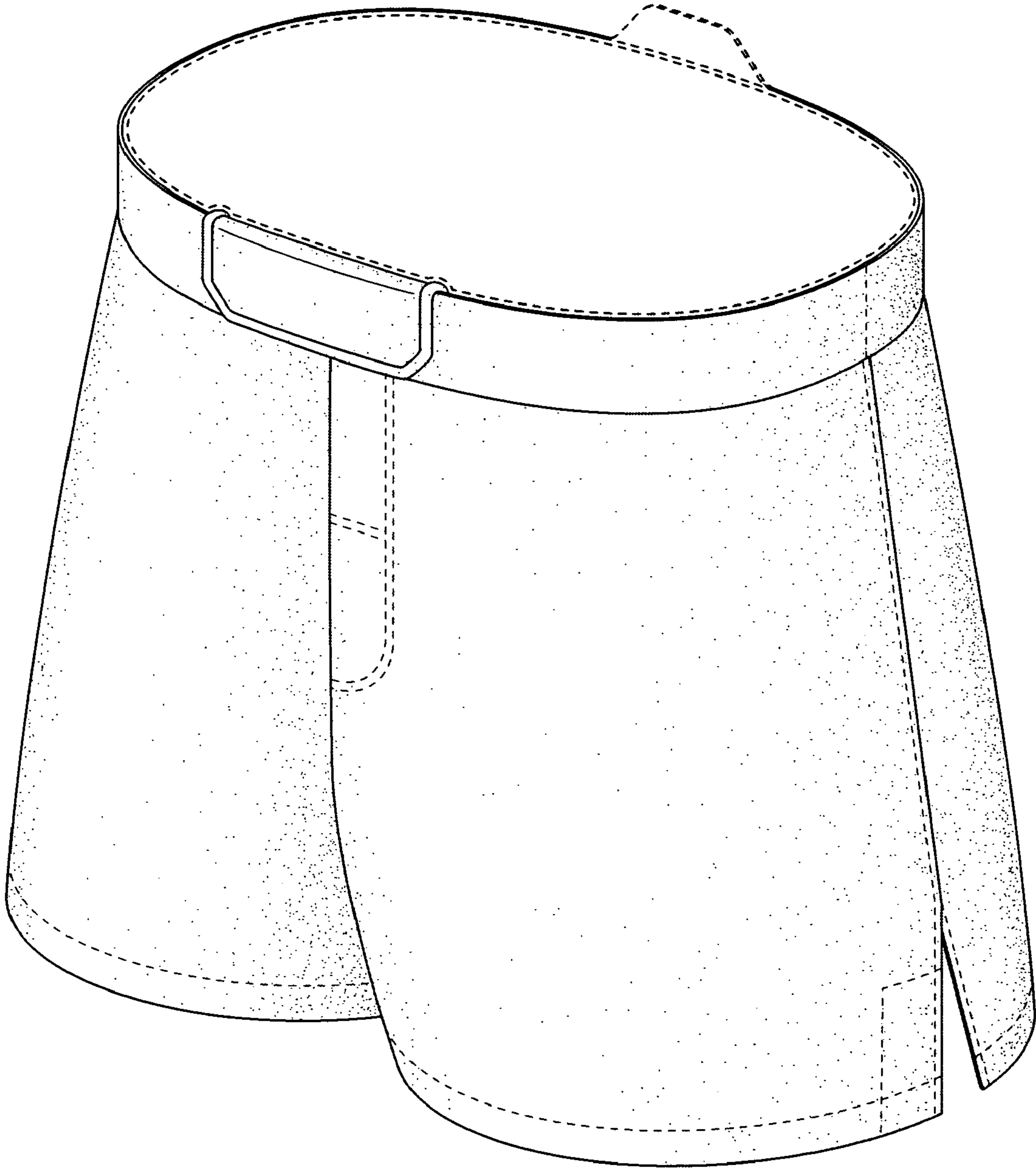

FIG. 1

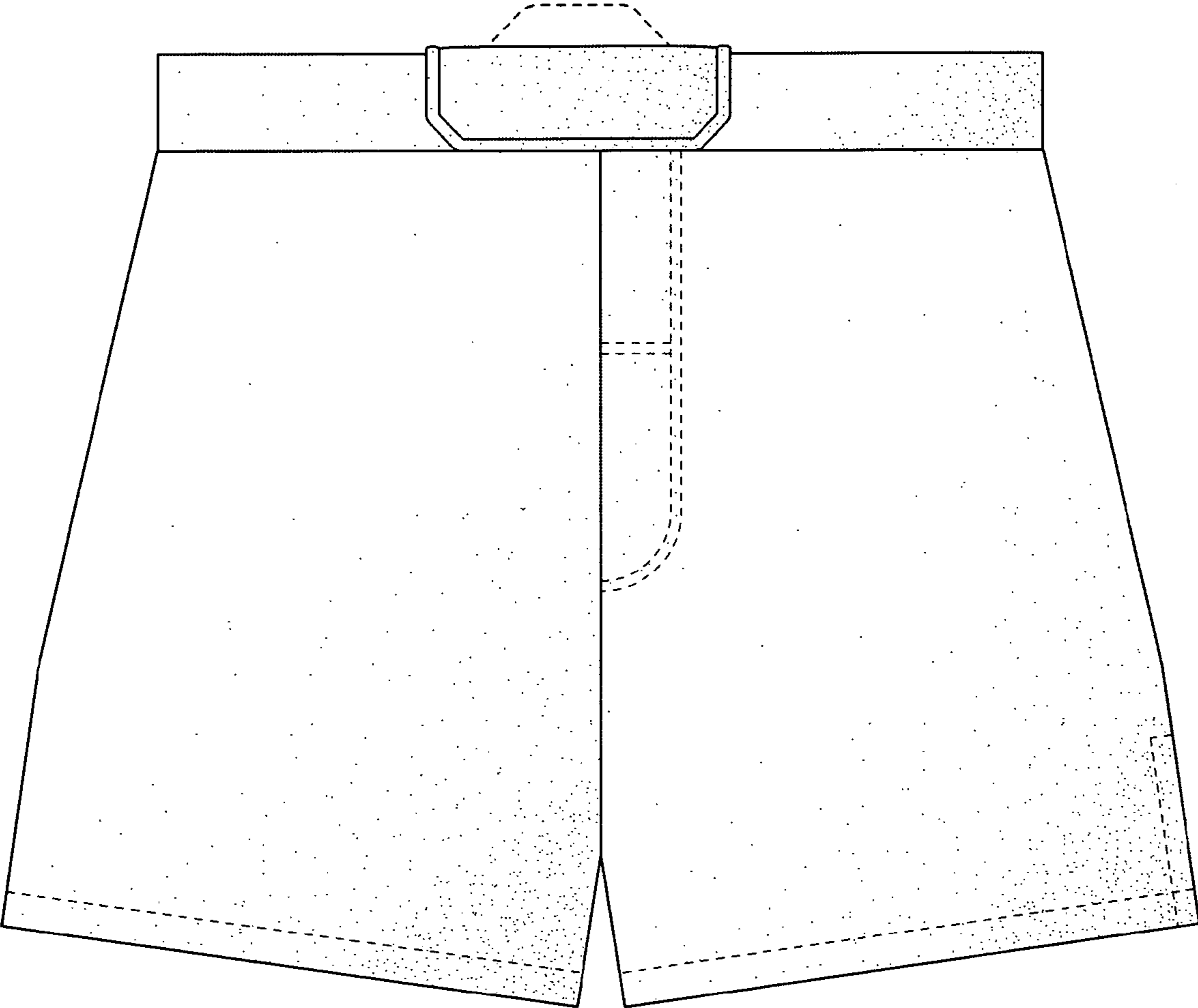

FIG. 2

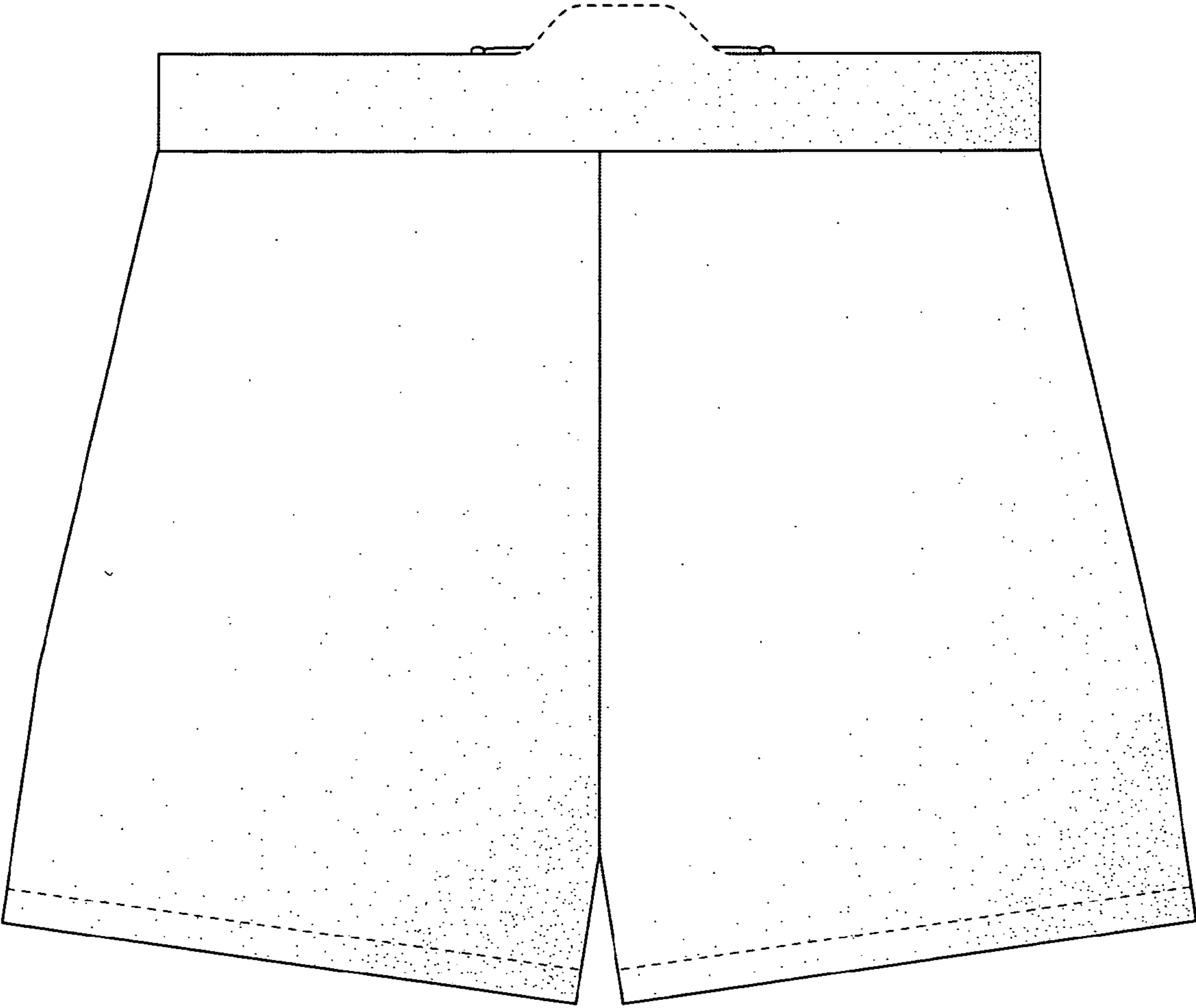

FIG. 3

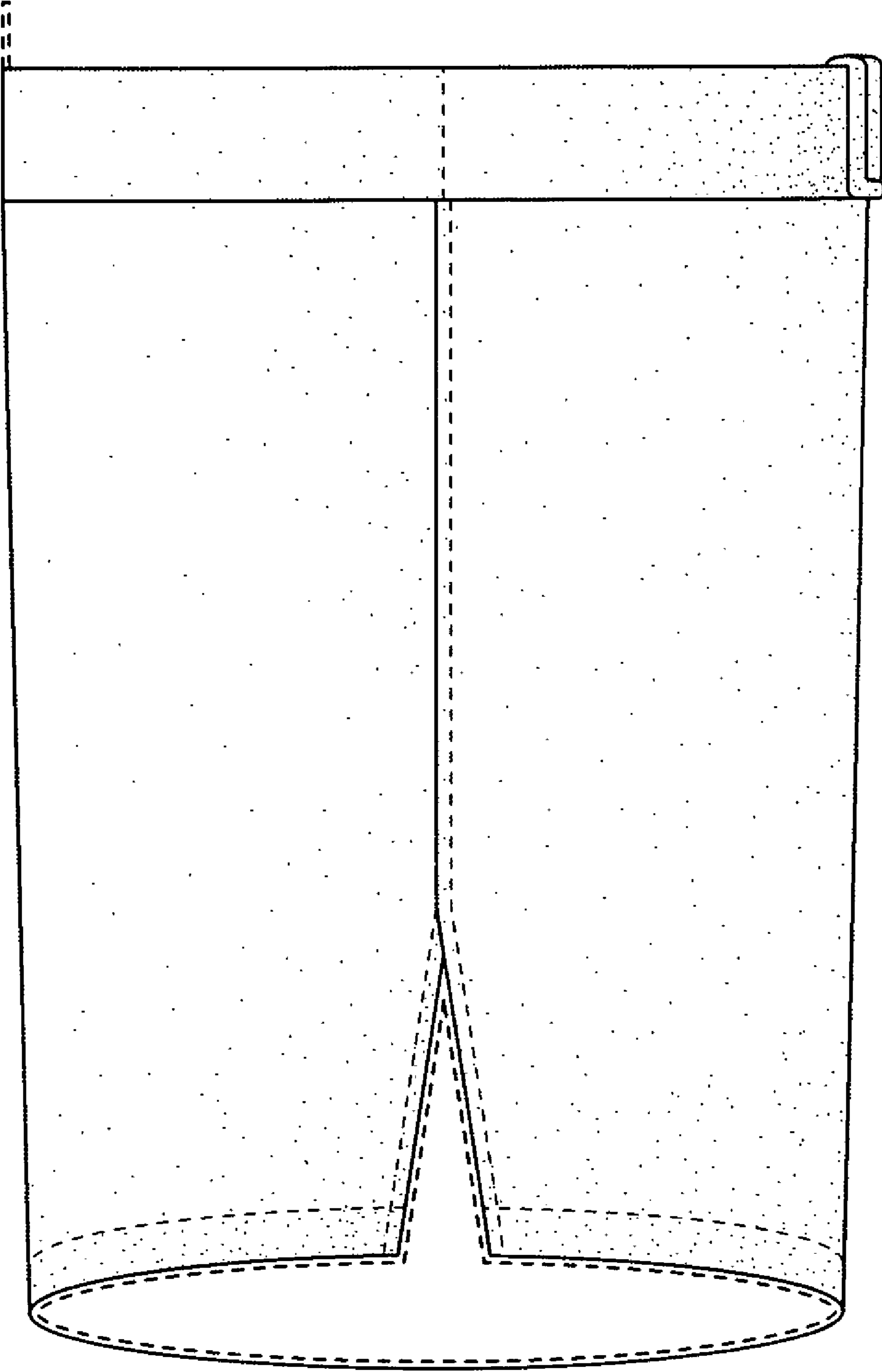

FIG. 4

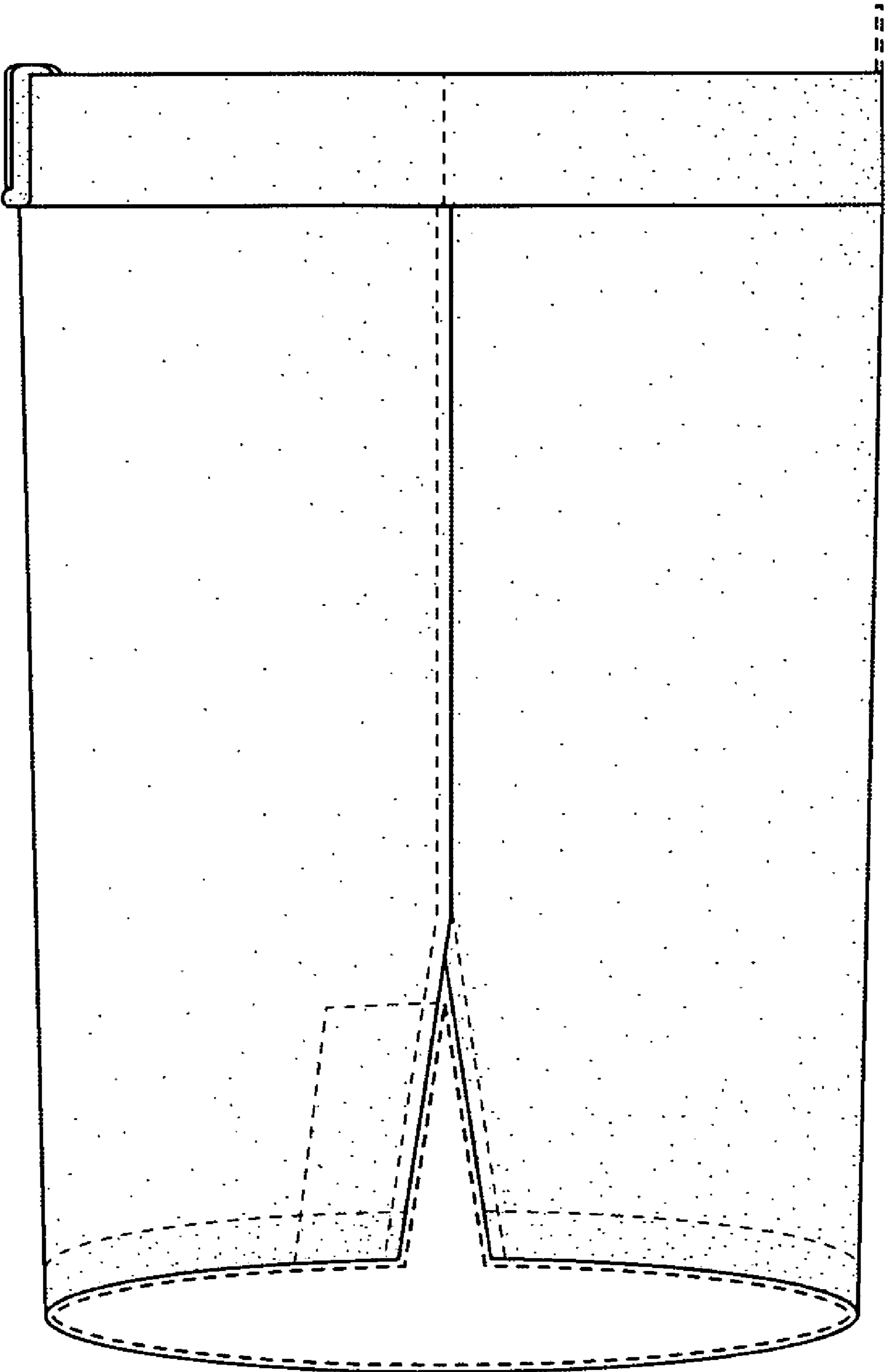

FIG. 5

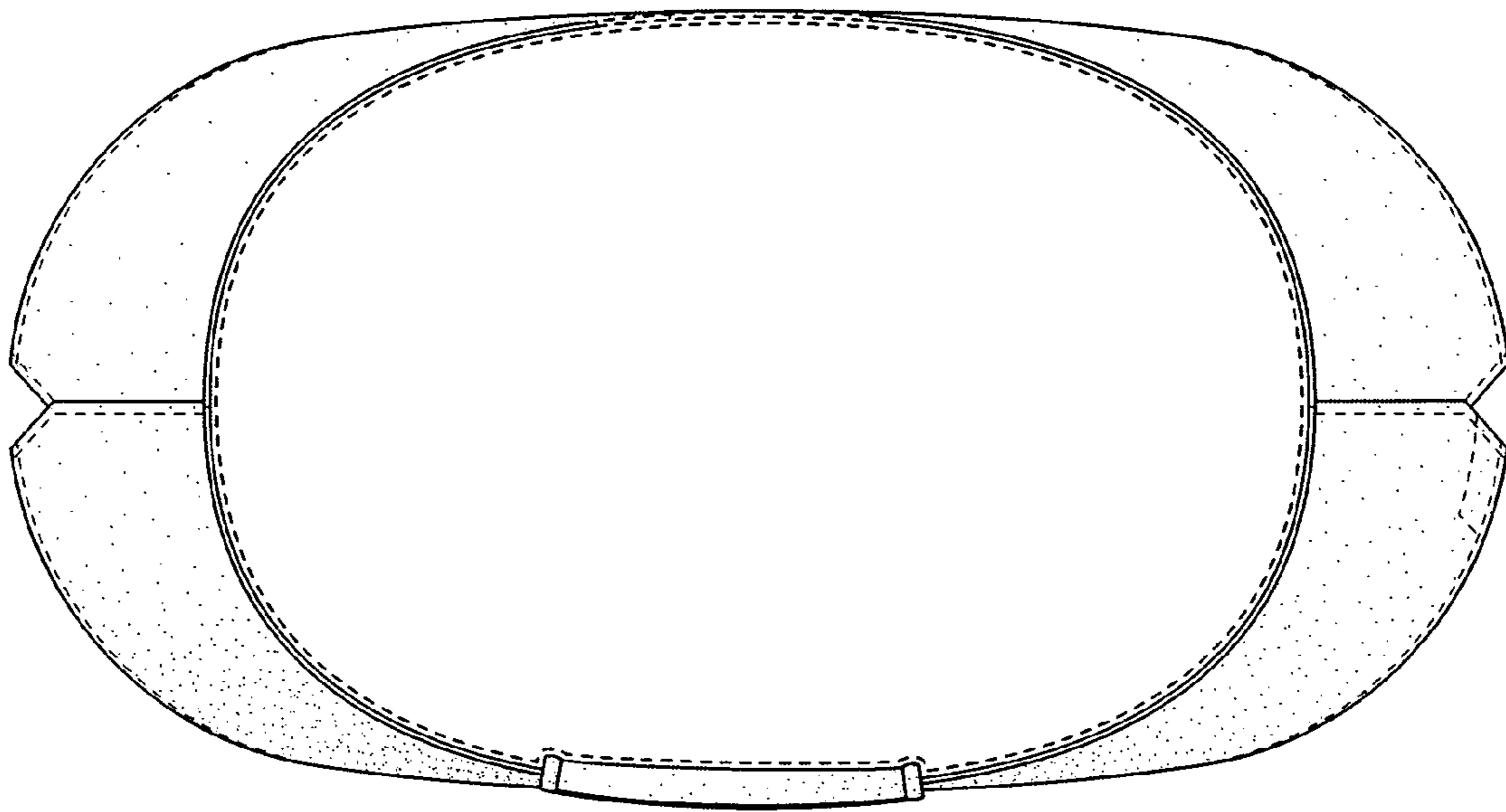

FIG. 6

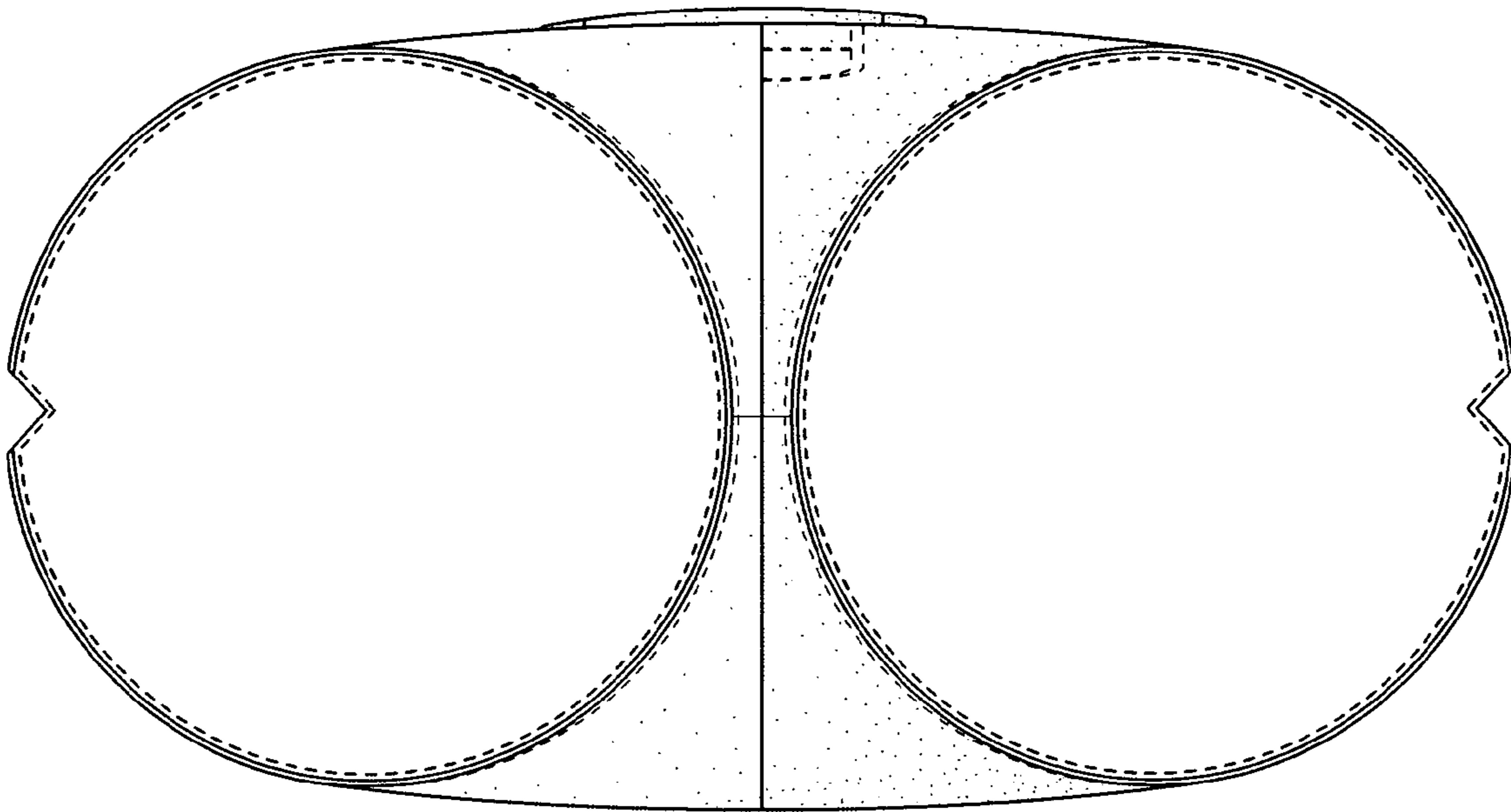

FIG. 7