



US00D674144S

(12) **United States Design Patent**  
**Yamamoto et al.**

(10) **Patent No.:** **US D674,144 S**  
(45) **Date of Patent:** **\*\* Jan. 8, 2013**

(54) **ELECTRIC SHAVER**

(75) Inventors: **Yuki Yamamoto**, Tokyo (JP); **Kouji Oomaki**, Tokyo (JP)

(73) Assignee: **Panasonic Corporation**, Kadoma-shi (JP)

(\*\*) Term: **14 Years**

(21) Appl. No.: **29/418,450**

(22) Filed: **Apr. 17, 2012**

(30) **Foreign Application Priority Data**

Oct. 18, 2011 (JP) ..... 2011-023883

(51) **LOC (9) Cl.** ..... **28-03**

(52) **U.S. Cl.** ..... **D28/51; D28/46**

(58) **Field of Classification Search** ..... D28/44,  
D28/44.1, 49-54; 30/34.05, 34.1, 34.2, 43-43.92,  
30/526, 527, 44-45, 29.5, 341, 195-223,  
30/272.1, 226-227, 231, 233-233.5

See application file for complete search history.

(56) **References Cited**

**U.S. PATENT DOCUMENTS**

917,589	A *	4/1909	Grabhorn	.....	30/47
3,964,160	A *	6/1976	Gordon	.....	30/531
4,332,321	A *	6/1982	Wratschko	.....	206/228
5,093,991	A *	3/1992	Hendrickson	.....	30/531
5,167,069	A *	12/1992	Quinn	.....	30/527
5,269,062	A *	12/1993	Dallaire et al.	.....	30/41
D400,301	S *	10/1998	Wong	.....	D28/45
7,140,116	B2 *	11/2006	Coffin	.....	30/531
D603,096	S *	10/2009	Greene	.....	D28/46

D623,800	S *	9/2010	Clemons	.....	D28/46
2007/0062043	A1 *	3/2007	Marut	.....	30/50
2012/0179170	A1 *	7/2012	Payne	.....	606/133

\* cited by examiner

*Primary Examiner* — Jennifer Rivard

(74) *Attorney, Agent, or Firm* — Marvin A. Motsenbocker; Mots Law, PLLC

(57) **CLAIM**

The ornamental design for an electric shaver, as shown and described.

**DESCRIPTION**

FIG. 1 is a front perspective view of an electric shaver with a cap;  
 FIG. 2 is a front view thereof;  
 FIG. 3 is a right side view thereof;  
 FIG. 4 is a top plan view thereof;  
 FIG. 5 is a rear view thereof;  
 FIG. 6 is a left side view thereof;  
 FIG. 7 is a bottom plan view thereof; and  
 FIG. 8 is a front perspective view thereof without the cap;  
 FIG. 9 is a front view thereof;  
 FIG. 10 is a right side view thereof;  
 FIG. 11 is a top plan view thereof;  
 FIG. 12 is a rear view thereof;  
 FIG. 13 is a left side view thereof;  
 FIG. 14 is a bottom plan view thereof;  
 FIG. 15 is an enlarged sectional view thereof, taken along line 15II-15II between 15I-15I of FIG. 13, in which the internal components are omitted; and,  
 FIG. 16 is a front view thereof showing a state that a blade portion is rotated in a horizontal position.  
 The portions of the article in broken lines are shown for illustrative purposes only and form no part of the claimed design.

**1 Claim, 16 Drawing Sheets**

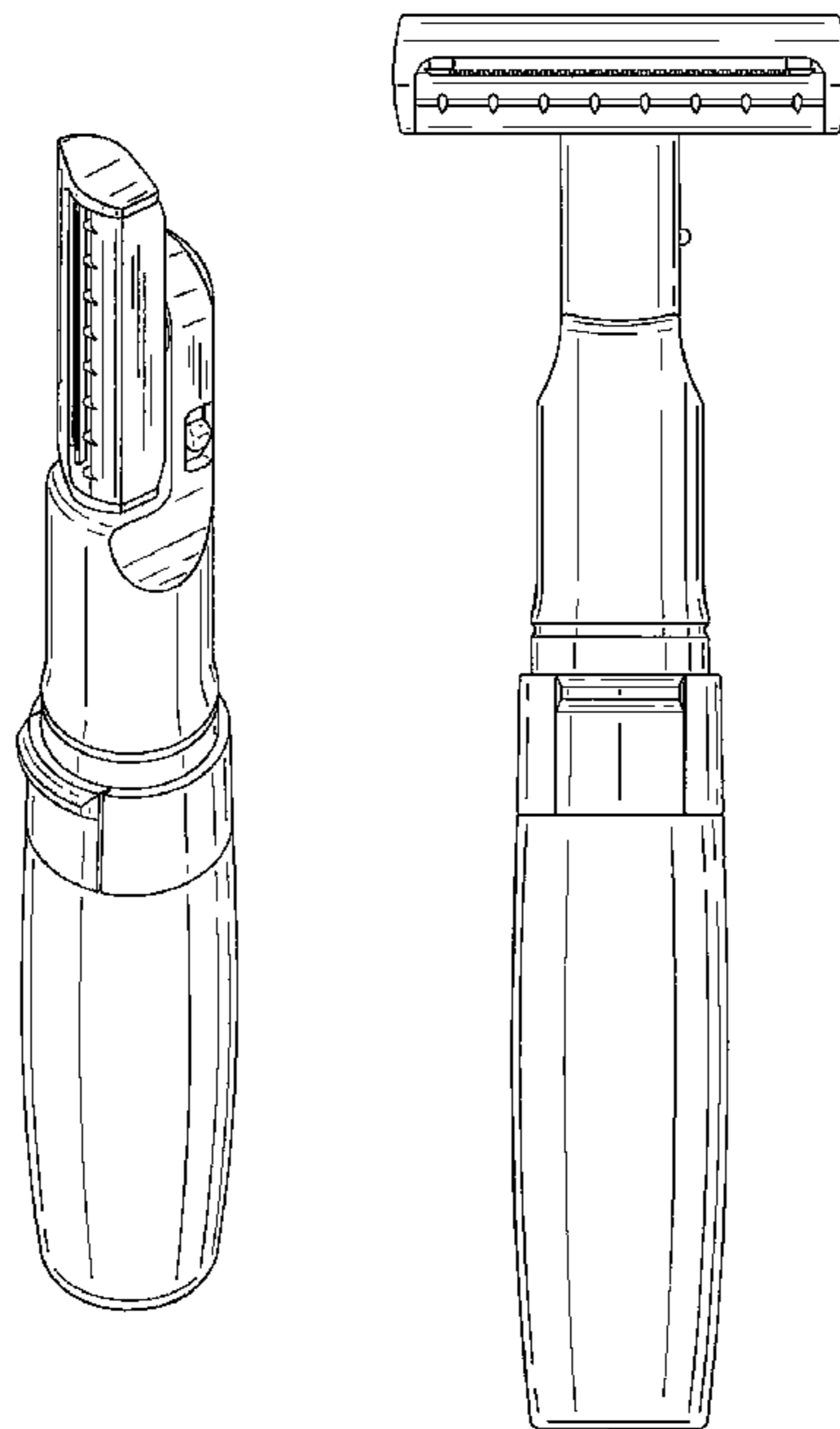

Fig. 1

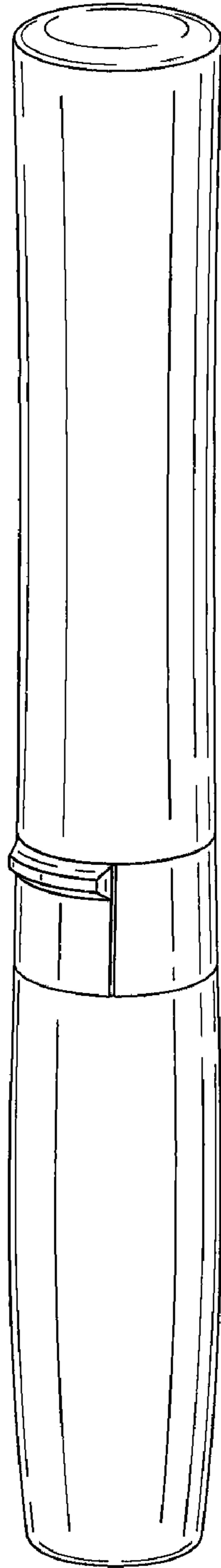

Fig.2

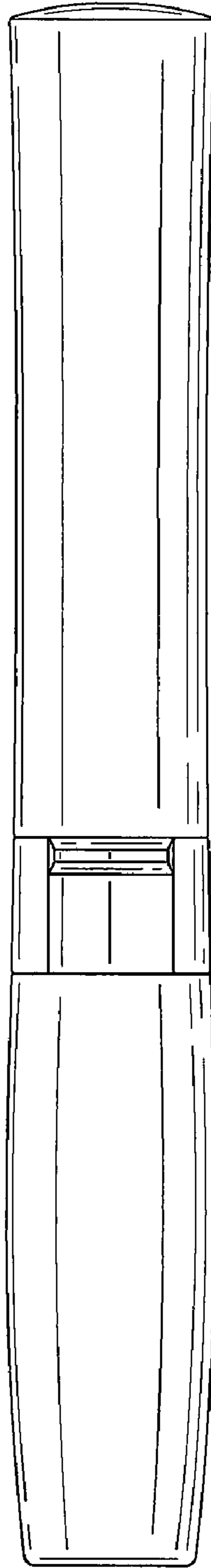

Fig.3

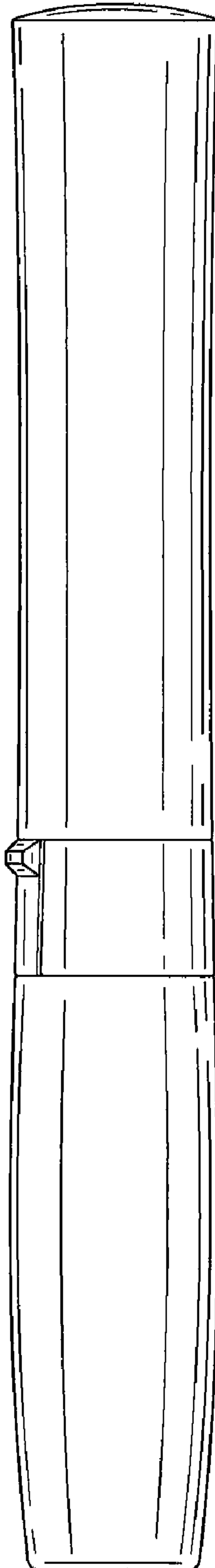

Fig.4

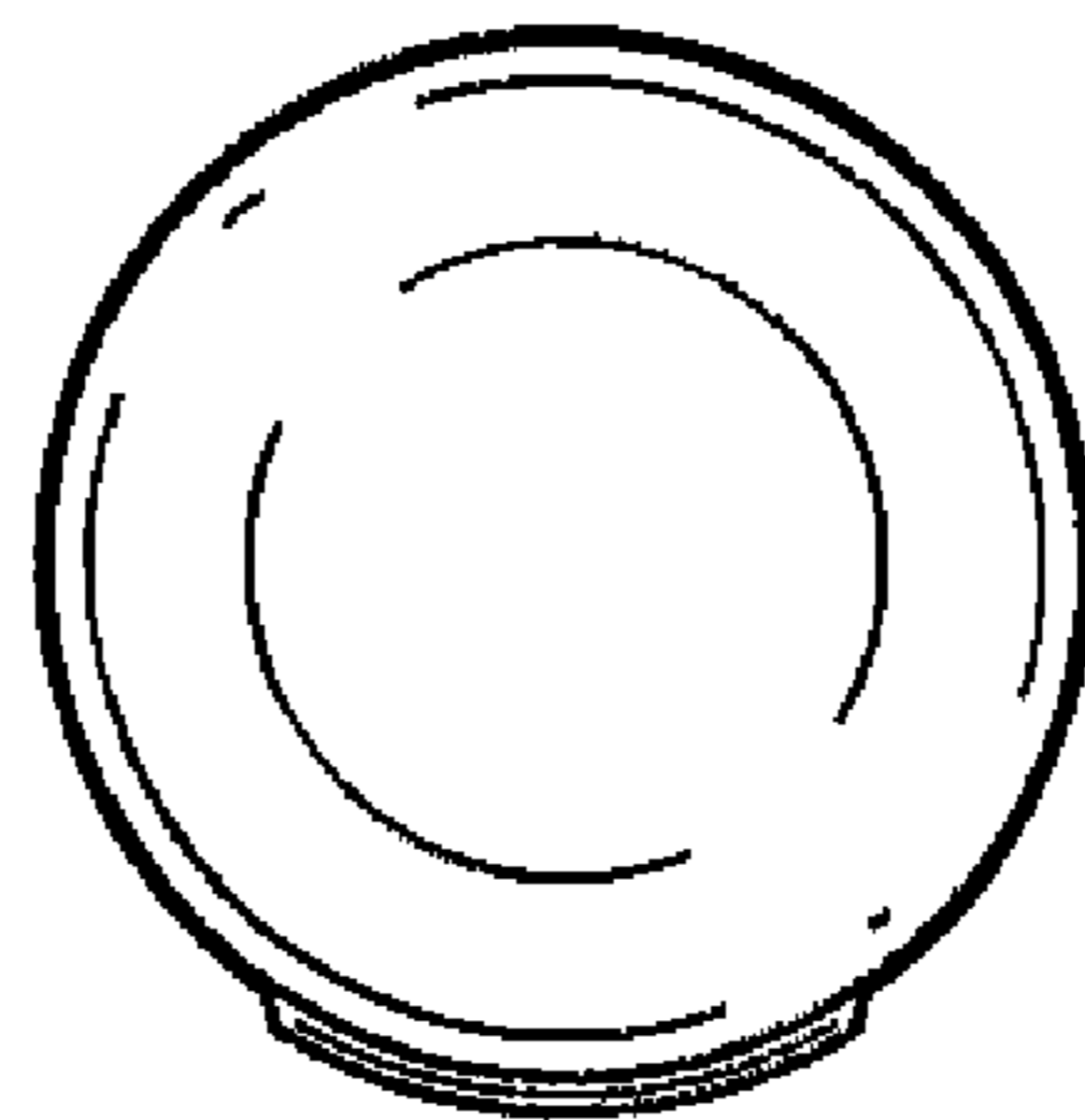

Fig.5

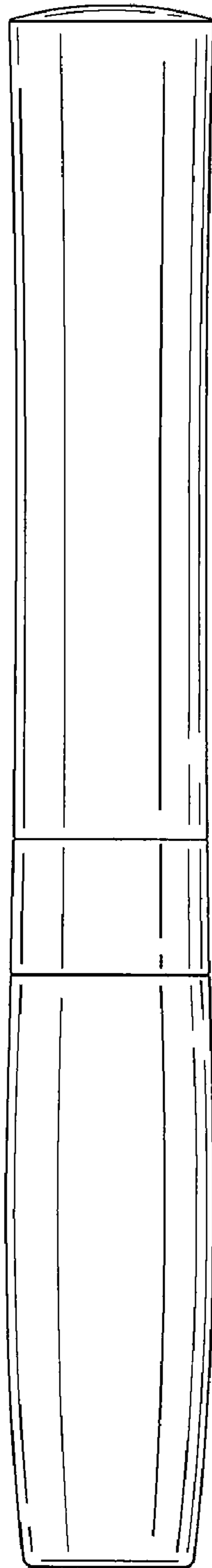
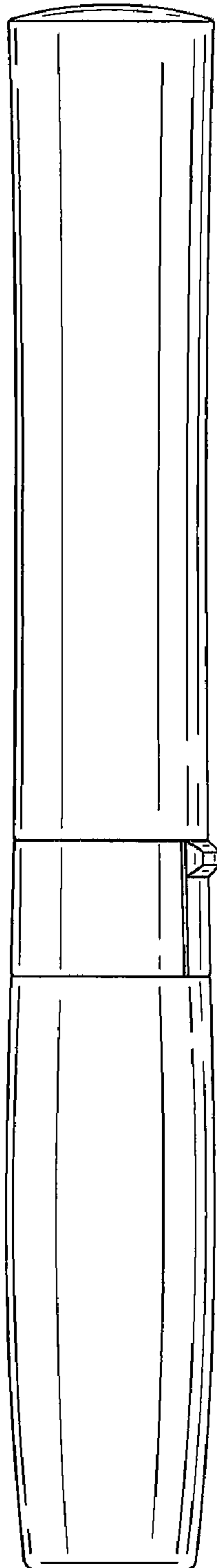

Fig.6



# Fig. 7

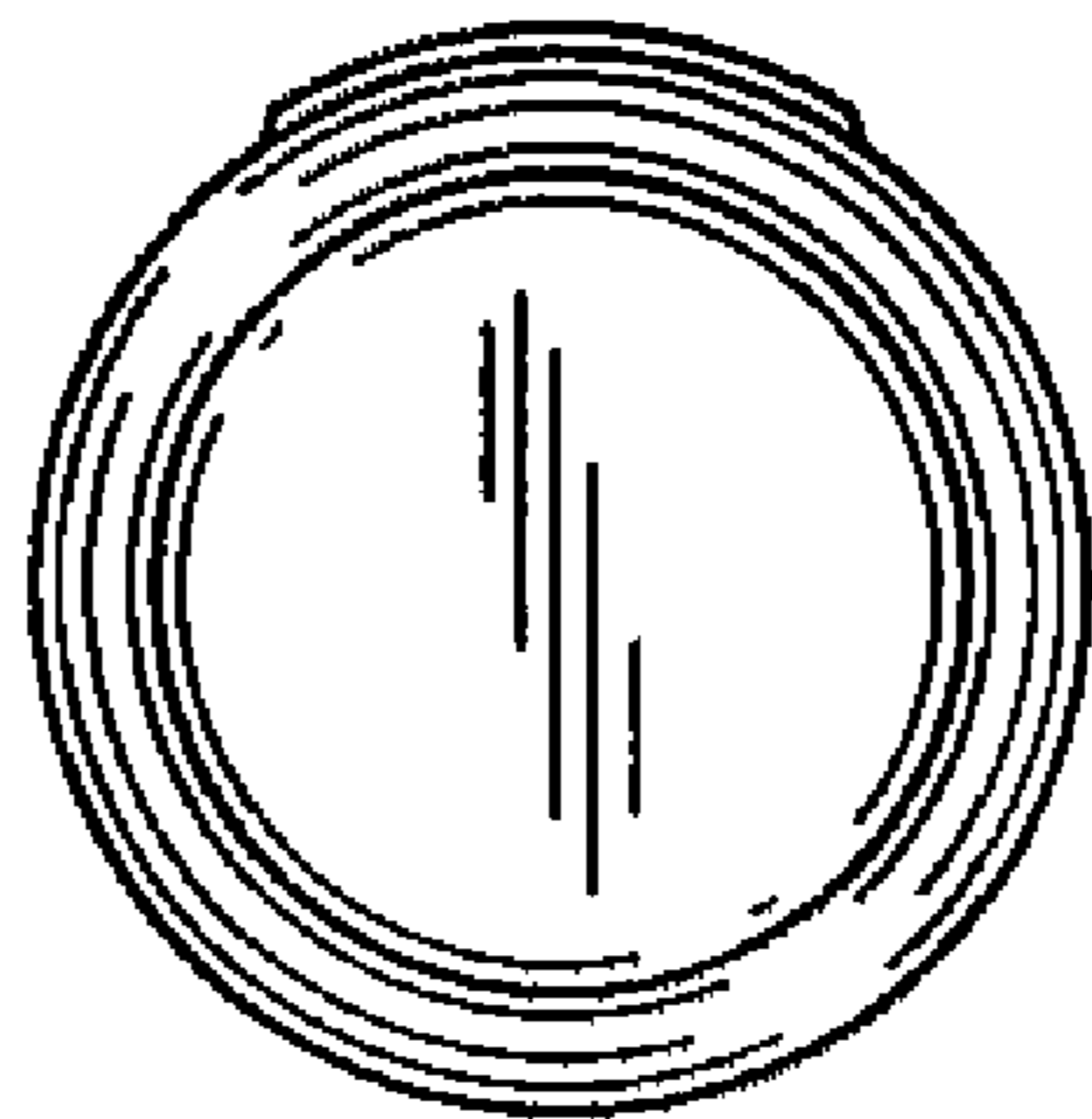



Fig.8

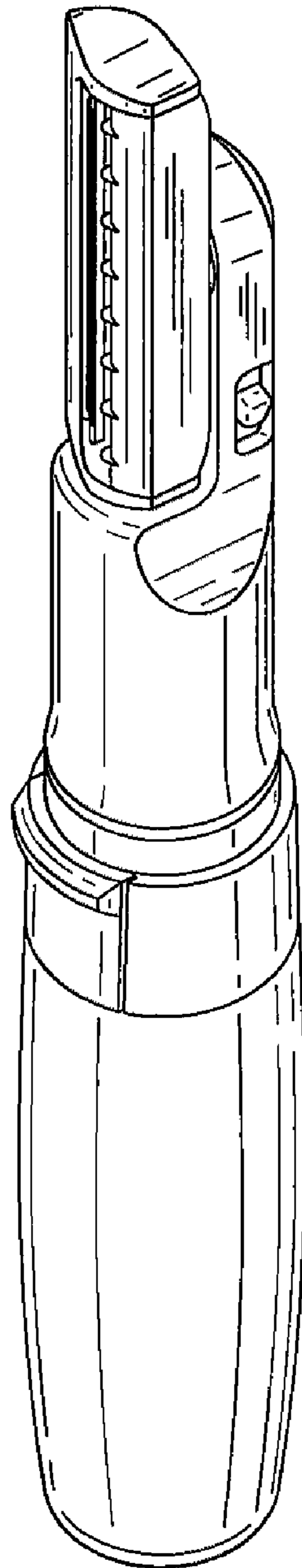

Fig.9

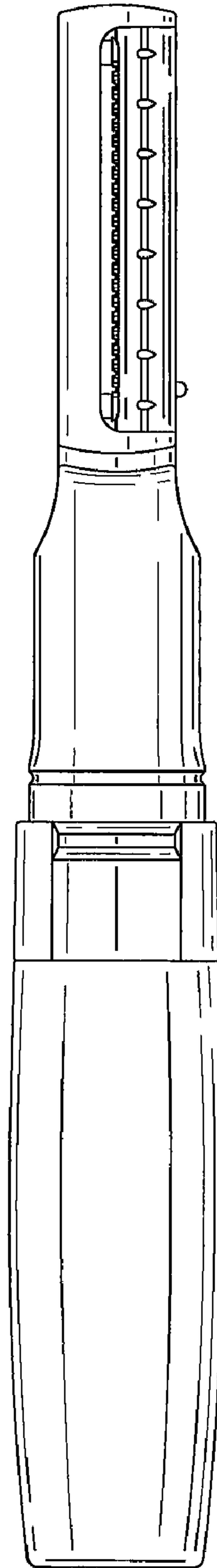
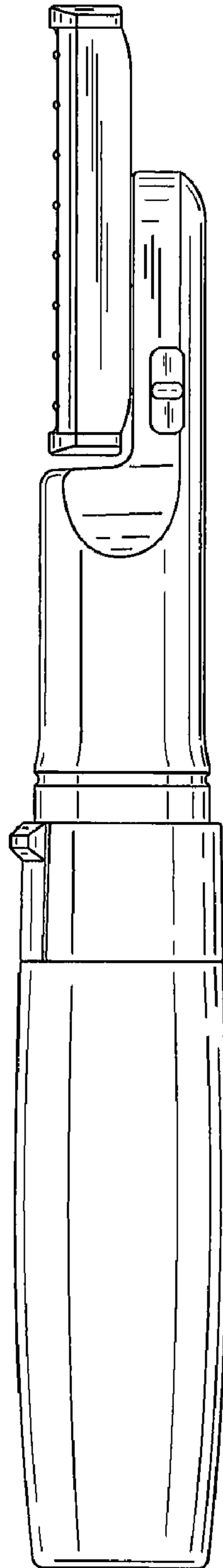

Fig. 10



# Fig. 11

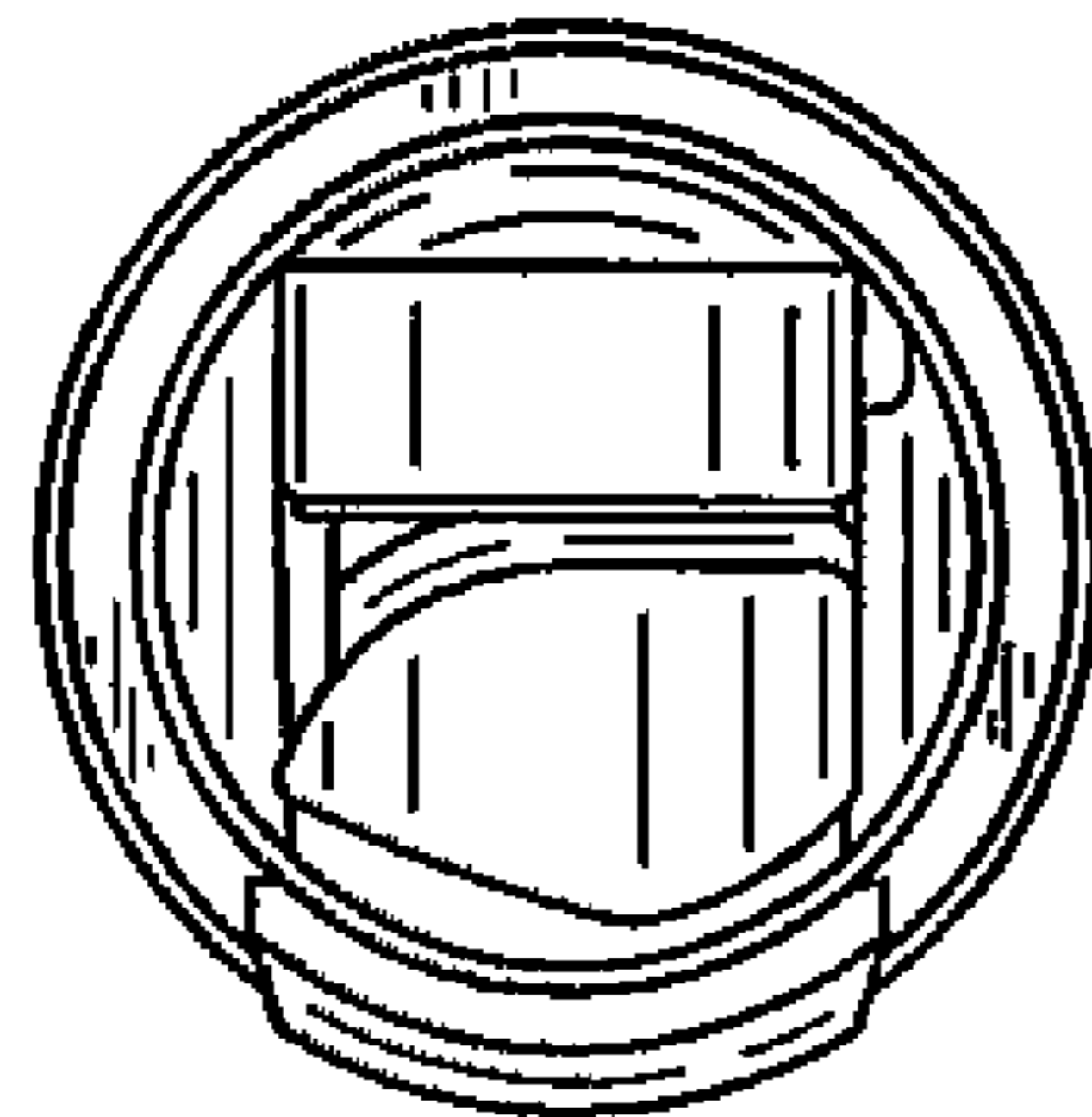

Fig. 12

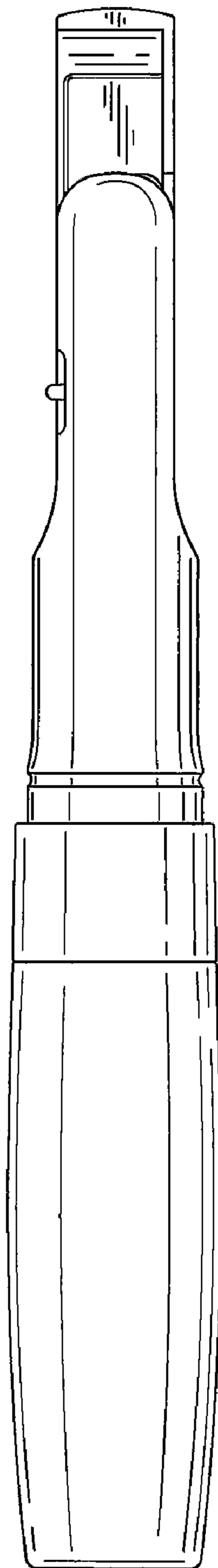
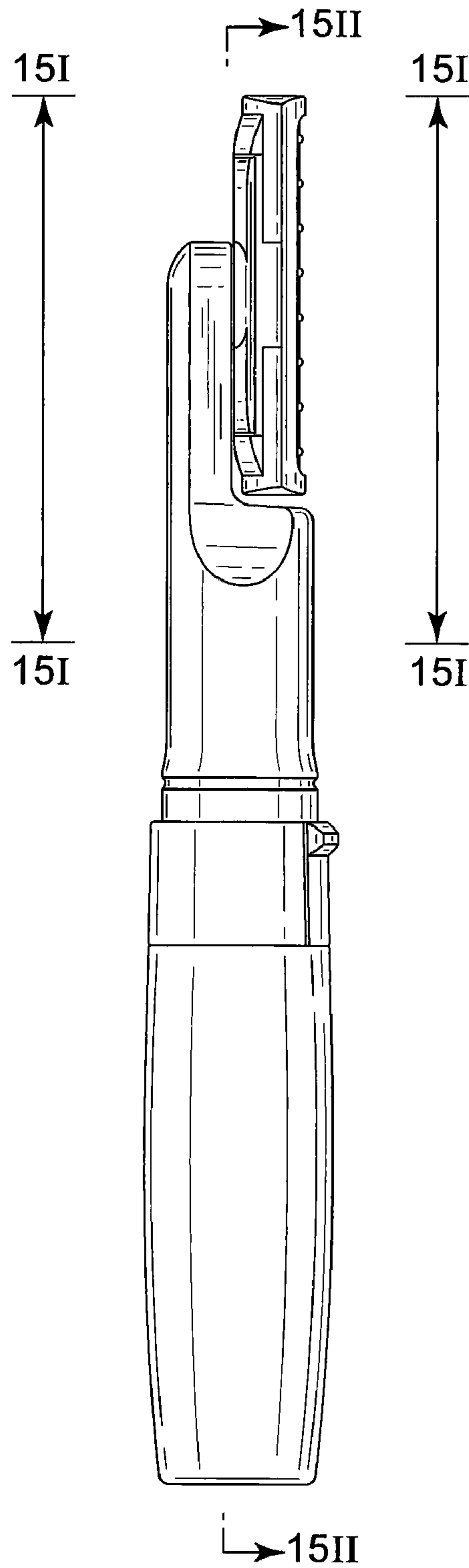

Fig. 13



# Fig. 14

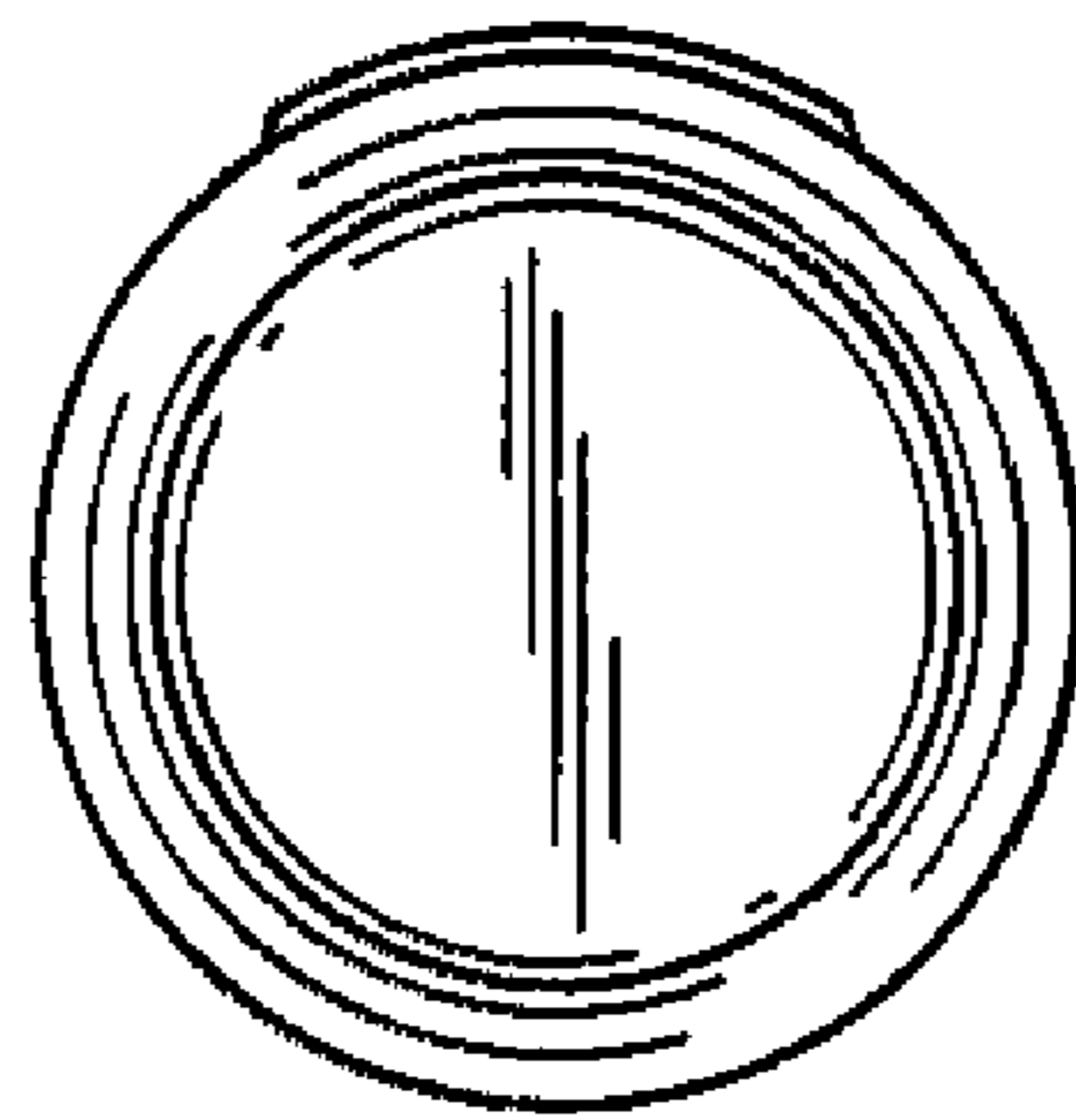

Fig. 15

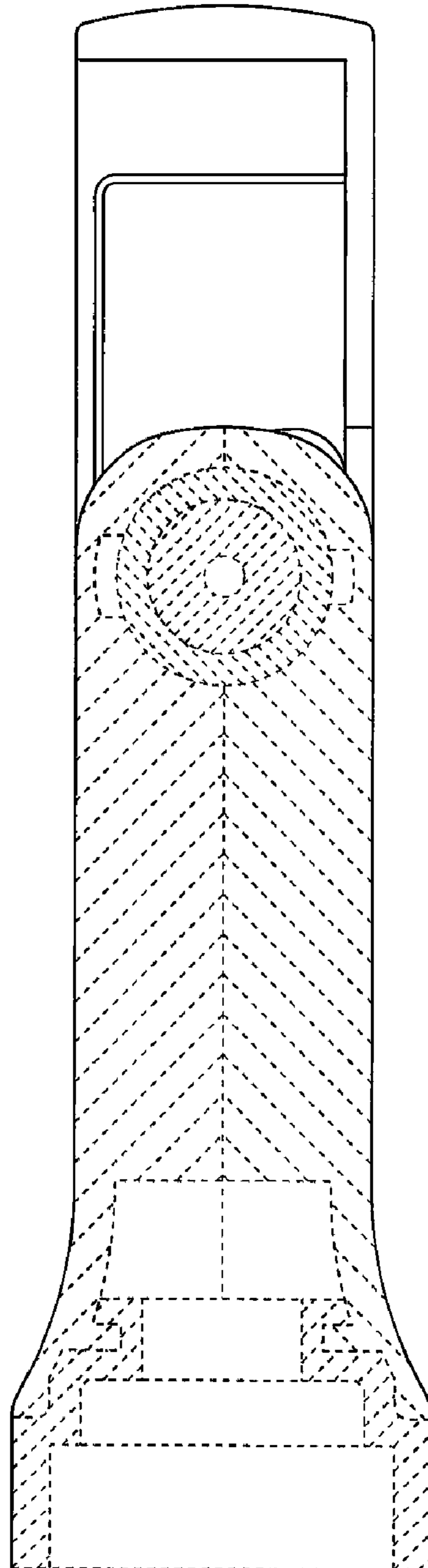



Fig. 16

