

US00D674076S

(12) **United States Design Patent**
Browder

(10) **Patent No.:** **US D674,076 S**
(45) **Date of Patent:** **** Jan. 8, 2013**

(54) **COVER FOR LIGHT AND/OR FRAGRANCE
EMITTER**

(75) Inventor: **John Browder**, Argyle, TX (US)

(73) Assignee: **IDC Enchanted Lighting Company,
LLC**, Roanoke, TX (US)

(**) Term: **14 Years**

(21) Appl. No.: **29/414,886**

(22) Filed: **Mar. 5, 2012**

(51) **LOC (9) Cl.** **28-99**

(52) **U.S. Cl.** **D23/367**

(58) **Field of Classification Search** D23/355-369;
D28/5, 6; 261/DIG. 17, DIG. 42, DIG. 65,
261/DIG. 88, DIG. 89; 392/386, 390, 394,
392/395; 239/34, 44, 53, 55, 56, 326; D26/14,
D26/17, 98, 9, 22, 24; D11/131.1; D7/509,
D7/522, 524, 537

See application file for complete search history.

(56) **References Cited**

U.S. PATENT DOCUMENTS

D112,985 S * 1/1939 Burnham D11/160
D136,532 S * 10/1943 Falardo D11/161
D312,058 S * 11/1990 Vermillion D11/128

D317,341 S * 6/1991 Cardillo D21/626
D353,634 S * 12/1994 Walsh D21/626
D404,093 S * 1/1999 Woods D21/626
D405,707 S * 2/1999 Smyth et al. D10/106.4
D417,707 S * 12/1999 Gilford D21/626
D442,651 S * 5/2001 Johnson D21/626
D480,770 S * 10/2003 Collins et al. D21/626
D518,120 S * 3/2006 James D21/626
D529,654 S * 10/2006 Norris et al. D26/67
D533,109 S * 12/2006 Brooks D11/160
D652,459 S * 1/2012 Adinolfi D21/626

* cited by examiner

Primary Examiner — Sandra Snapp

(74) *Attorney, Agent, or Firm* — Brian Harris

(57) **CLAIM**

The ornamental design for a cover for light and/or fragrance emitter, as shown and described.

DESCRIPTION

FIG. 1 is a perspective view of a cover for light and/or fragrance emitter showing my new design;
FIG. 2 is a front view thereof;
FIG. 3 is a back view thereof;
FIG. 4 is a right side view thereof;
FIG. 5 is a left side view thereof;
FIG. 6 is a top view thereof; and,
FIG. 7 is a bottom view thereof.

The broken lines form no part of the claimed design.

1 Claim, 7 Drawing Sheets

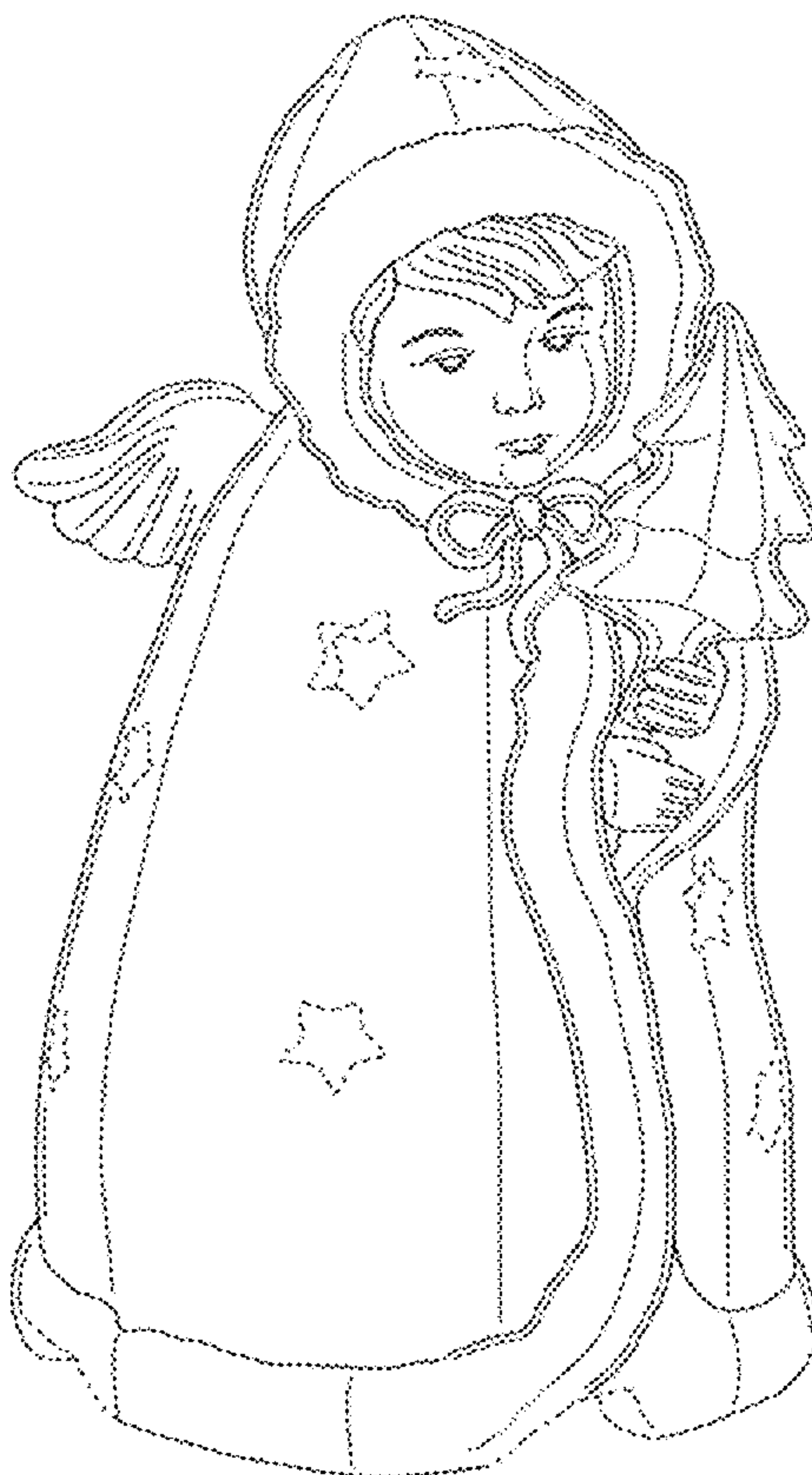

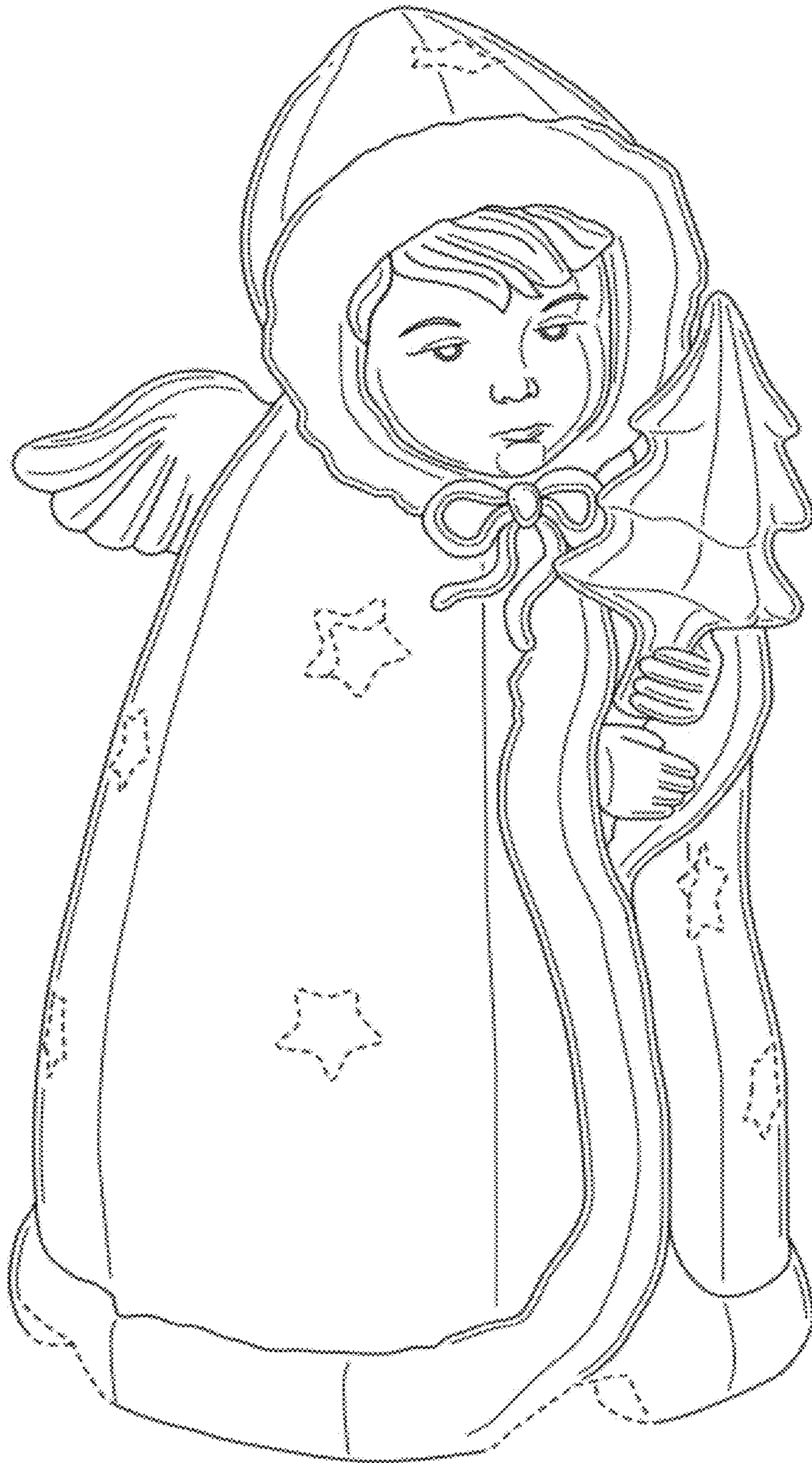

FIG. 1

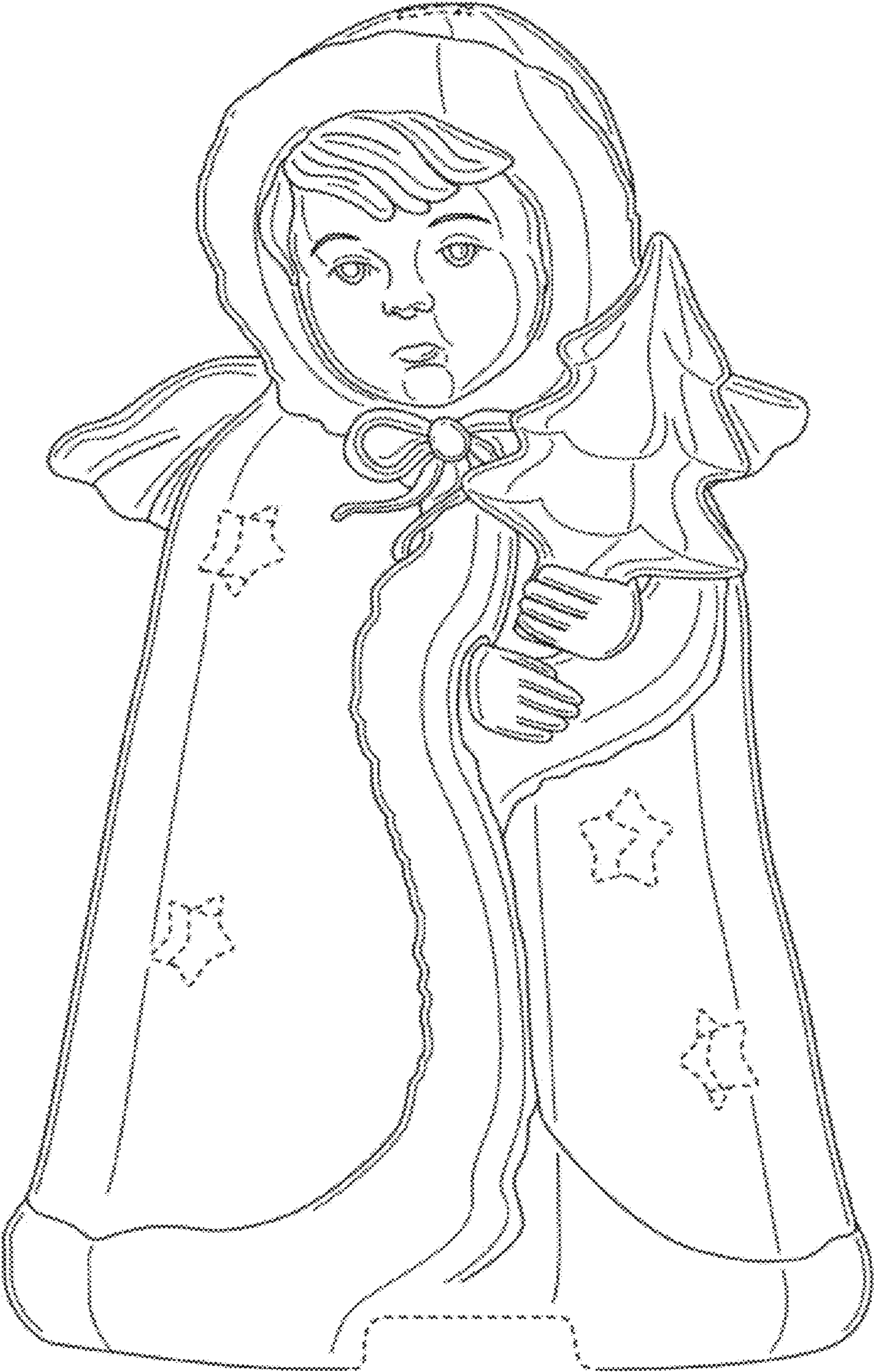

FIG. 2



FIG. 3

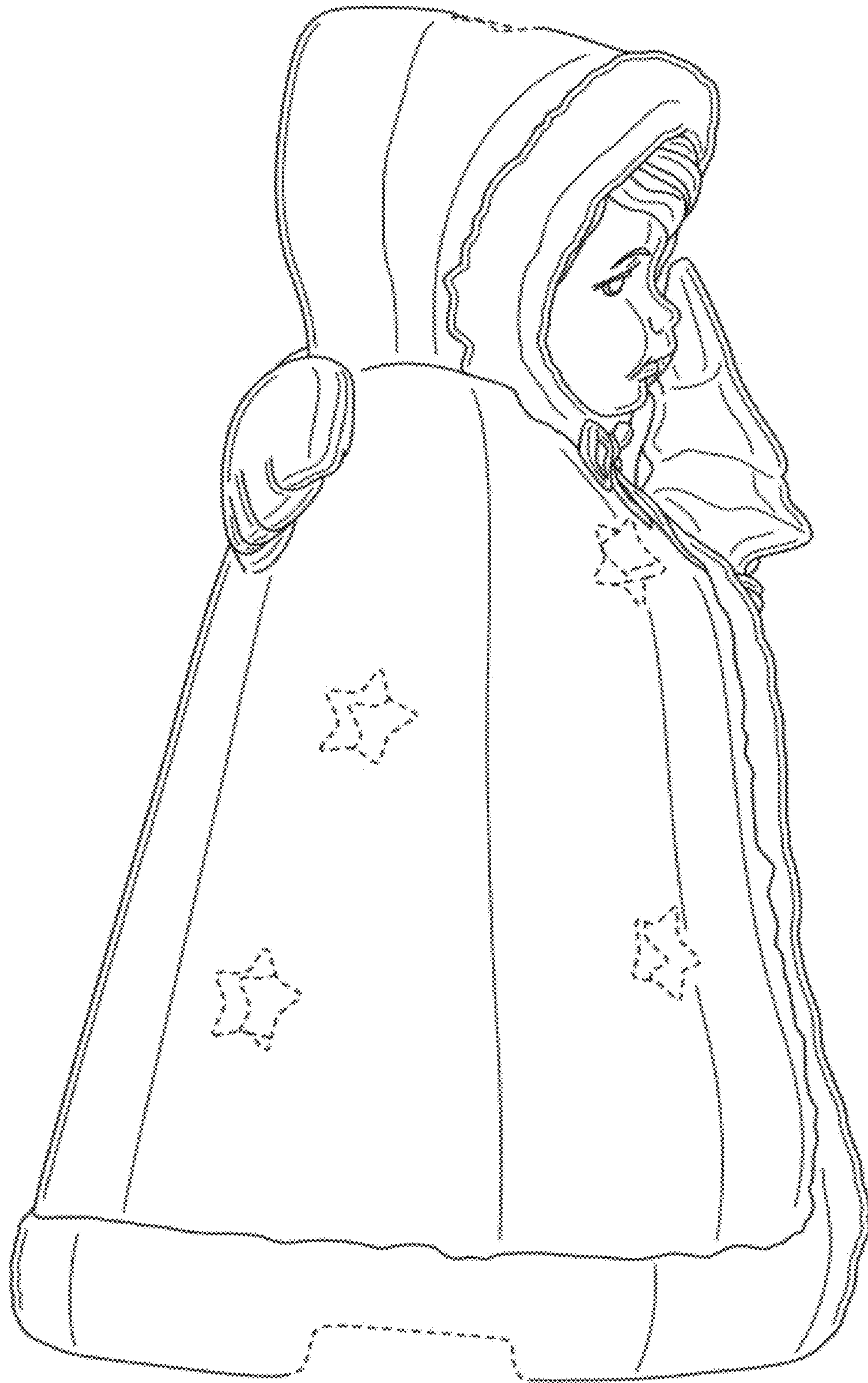

FIG. 4

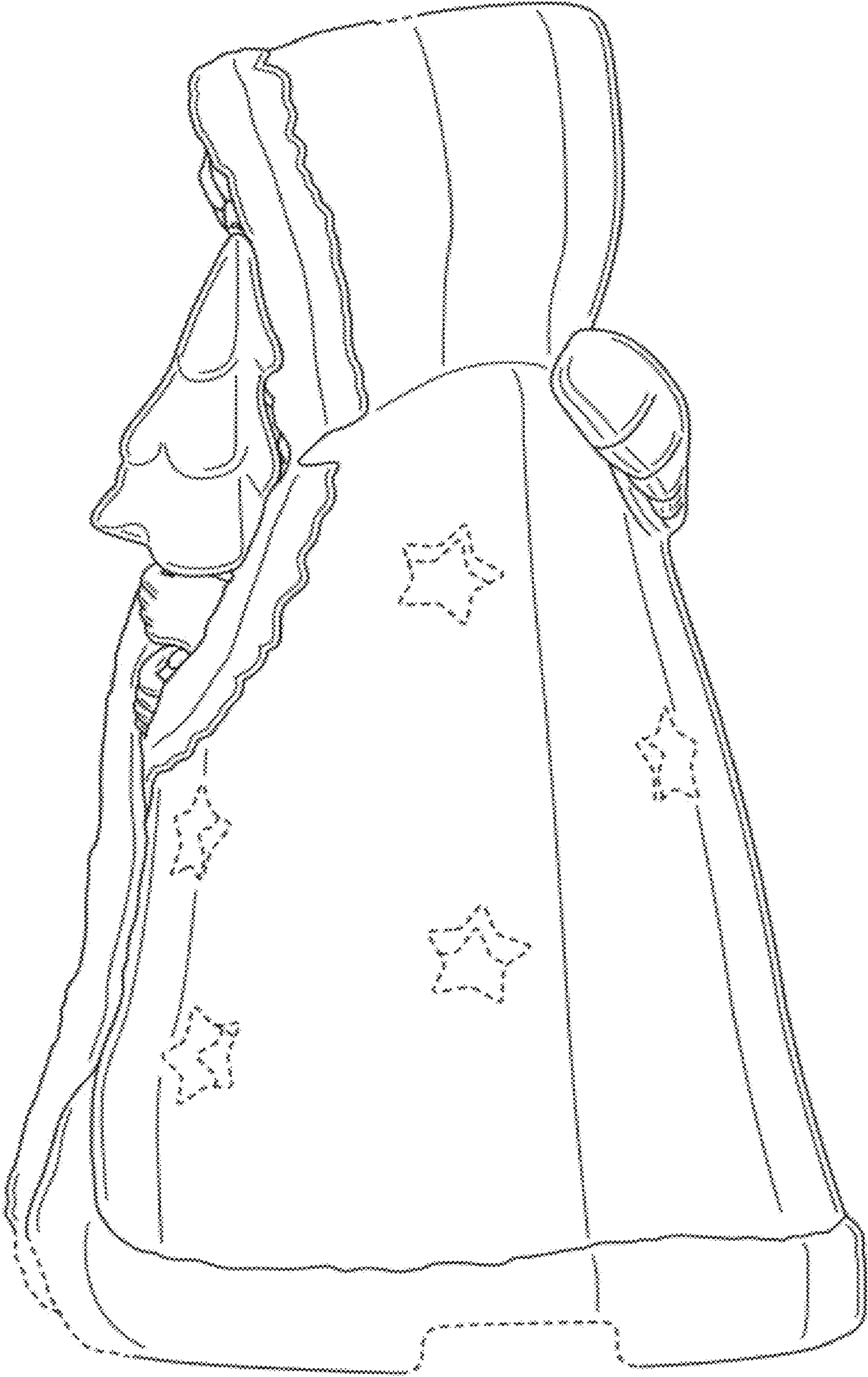

FIG. 5



FIG. 6

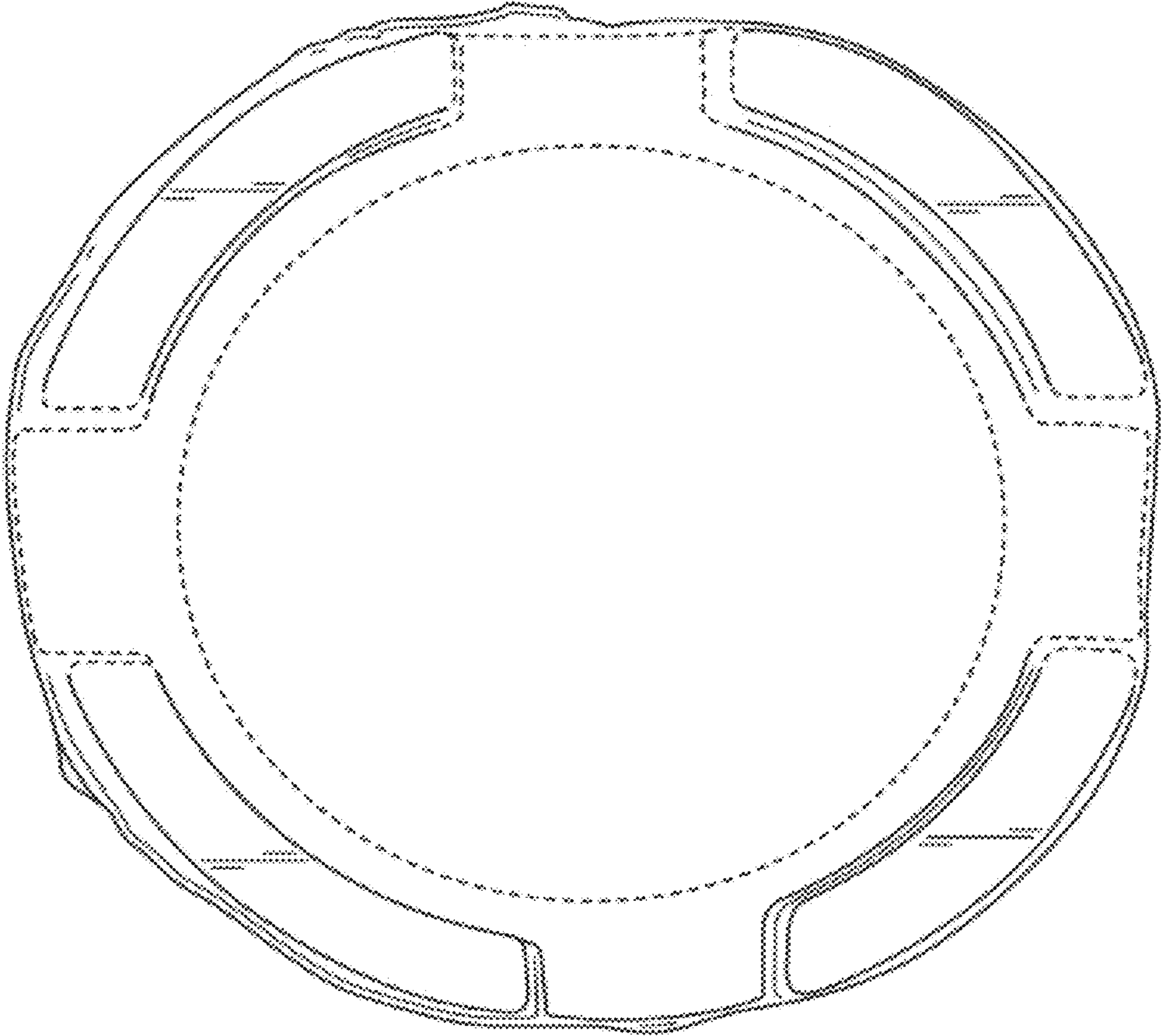

FIG. 7