



US00D674022S

(12) **United States Design Patent**
Rovinelli

(10) **Patent No.:** **US D674,022 S**

(45) **Date of Patent:** **** Jan. 8, 2013**

(54) **PORTABLE EMERGENCY SIGN POCKET**

5,649,379 A 7/1997 Hoffman et al.
6,053,281 A 4/2000 Murray
6,135,190 A 10/2000 Gompertz et al.

(76) Inventor: **Jesse Rovinelli**, Sudbury (CA)

* cited by examiner

(**) Term: **14 Years**

Primary Examiner — Mary Ann Calabrese

(21) Appl. No.: **29/401,451**

(74) *Attorney, Agent, or Firm* — Montgomery Patent & Design LLC; Robert C. Montgomery; Joseph Yaksich

(22) Filed: **Sep. 12, 2011**

(51) **LOC (9) Cl.** **20-03**

(52) **U.S. Cl.** **D20/42; D20/19**

(58) **Field of Classification Search** D20/10,
D20/19, 21, 29, 30, 34, 37, 39-43, 99;
40/124.01-124.09, 124.11-124.09, 124.191,
40/446, 538, 541, 542, 584, 564, 591, 617,
40/618; D3/215, 226, 227, 230; D6/596;
D10/104.1, 109.1, 109.2; 116/28 R; 150/147;
160/328; 383/42, 84, 86

See application file for complete search history.

(57) **CLAIM**

The ornamental design for a portable emergency sign pocket, as shown and described.

DESCRIPTION

FIG. 1 is a perspective view of a portable emergency sign pocket depicted in a closed state attached to a connector chain, showing my new design;
FIG. 2 is a front view of the portable emergency sign pocket depicted in an open state;
FIG. 3 is a rear view thereof;
FIG. 4 is a left side view thereof;
FIG. 5 is a right side view thereof;
FIG. 6 is a top view thereof; and,
FIG. 7 is a bottom view thereof.

The broken line showing of connector chains in FIG. 1 and emergency indicia in FIGS. 1 and 2 is for the purpose of illustrating environment and forms no part of the claimed design.

1 Claim, 5 Drawing Sheets

(56) **References Cited**

U.S. PATENT DOCUMENTS

1,073,768	A *	9/1913	Loveland	150/147
1,104,463	A *	7/1914	Wuest	383/86
2,671,423	A	3/1954	Mead	
3,325,936	A	6/1967	Swartz	
3,590,506	A	7/1971	Jeski	
D230,117	S *	1/1974	Johnson	D6/596
D234,472	S *	3/1975	Fosher	D20/43
D252,355	S *	7/1979	Uber	D3/226
D288,744	S *	3/1987	Taylor	D3/226
D365,204	S *	12/1995	Chen	D3/215
D376,287	S *	12/1996	Bennett	D6/596

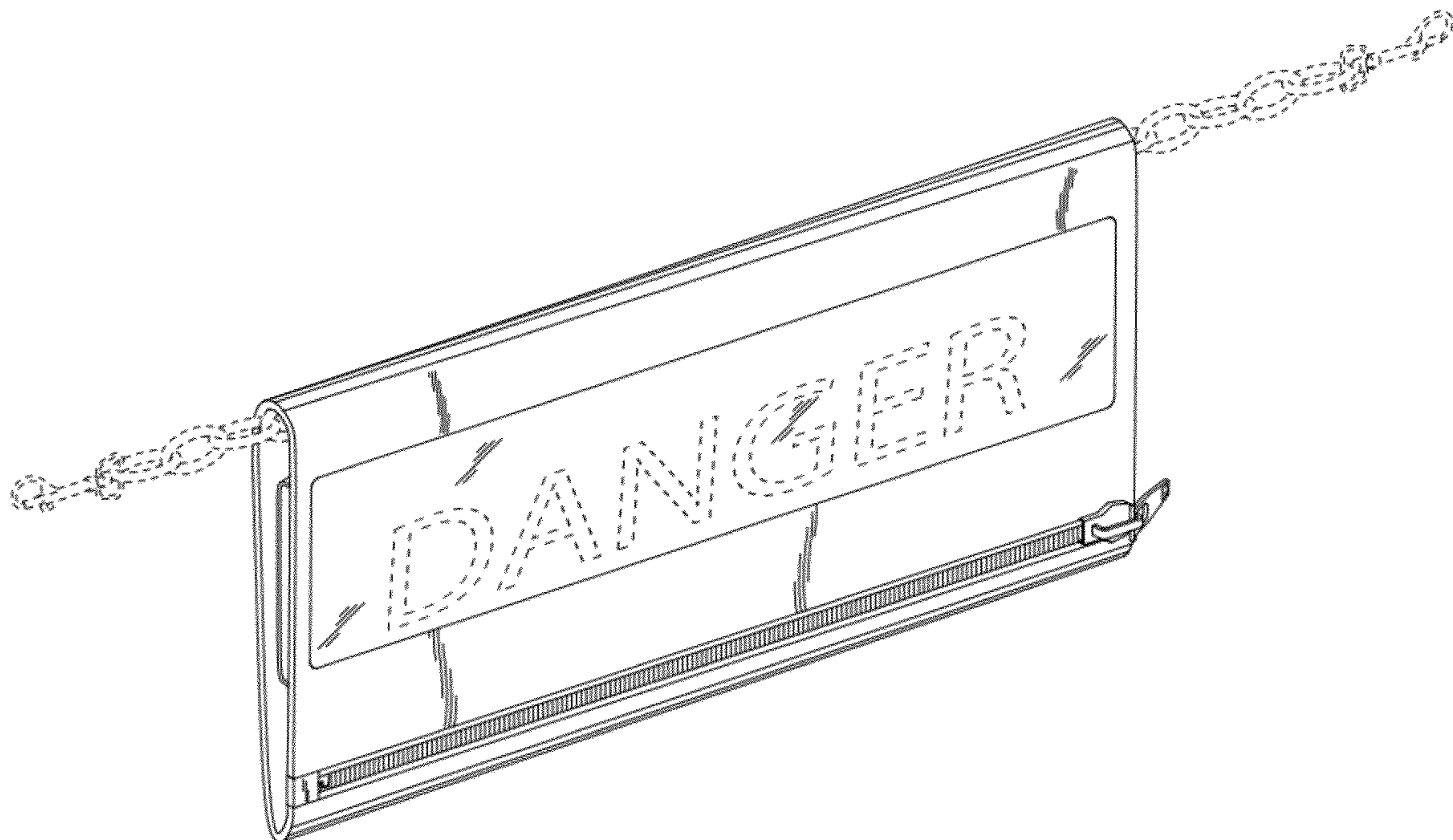

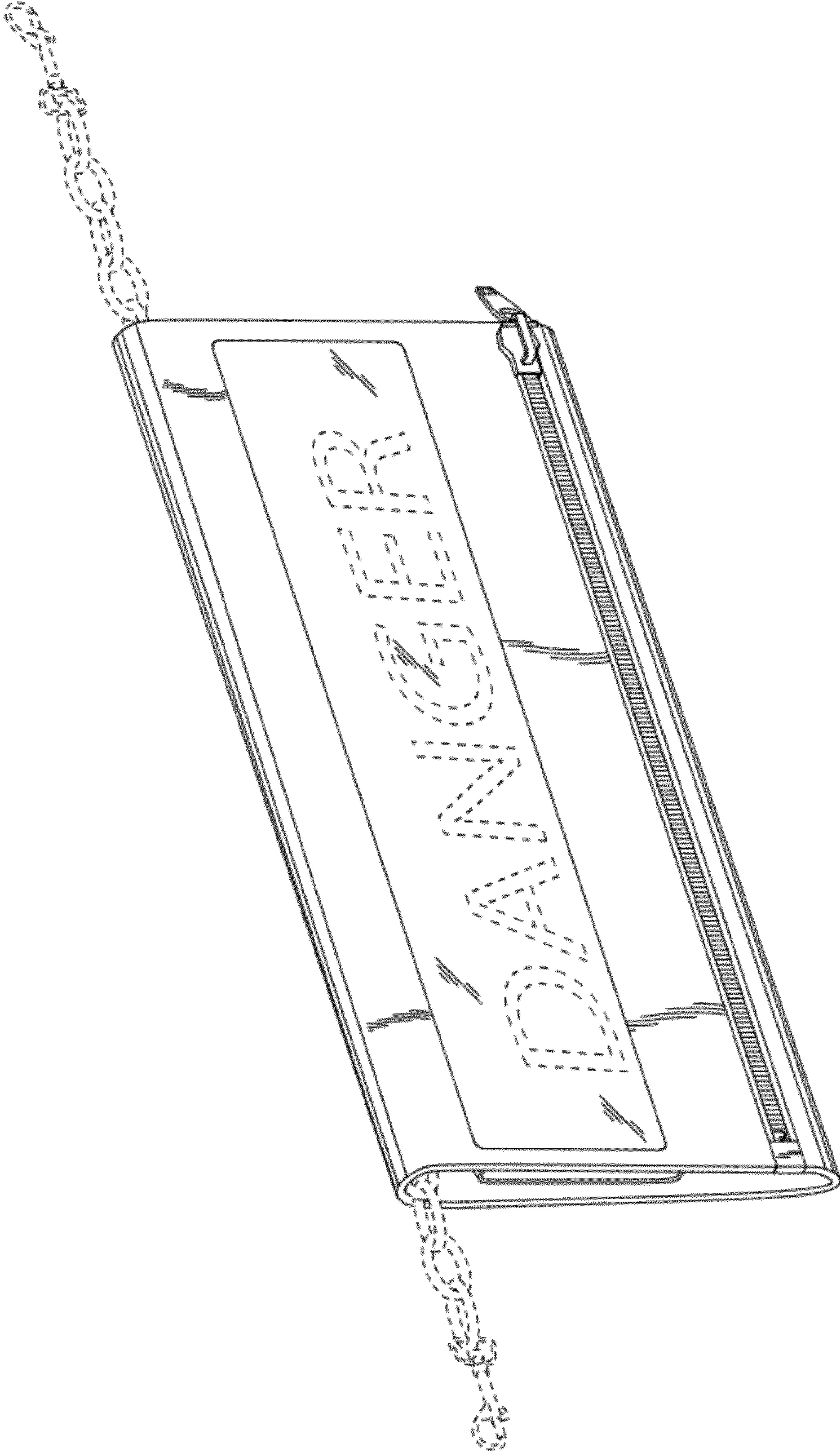

Fig. 1

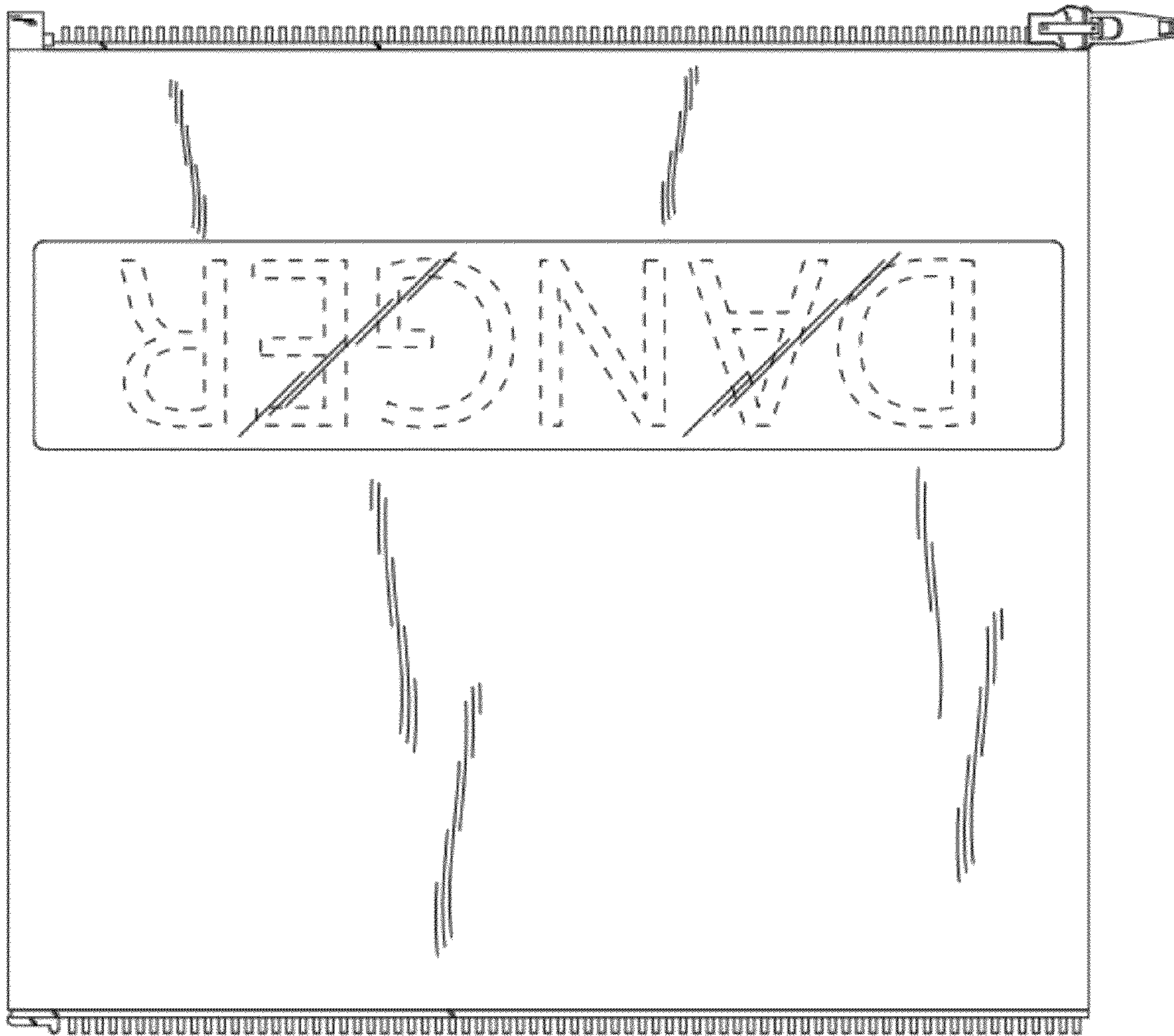

Fig. 2

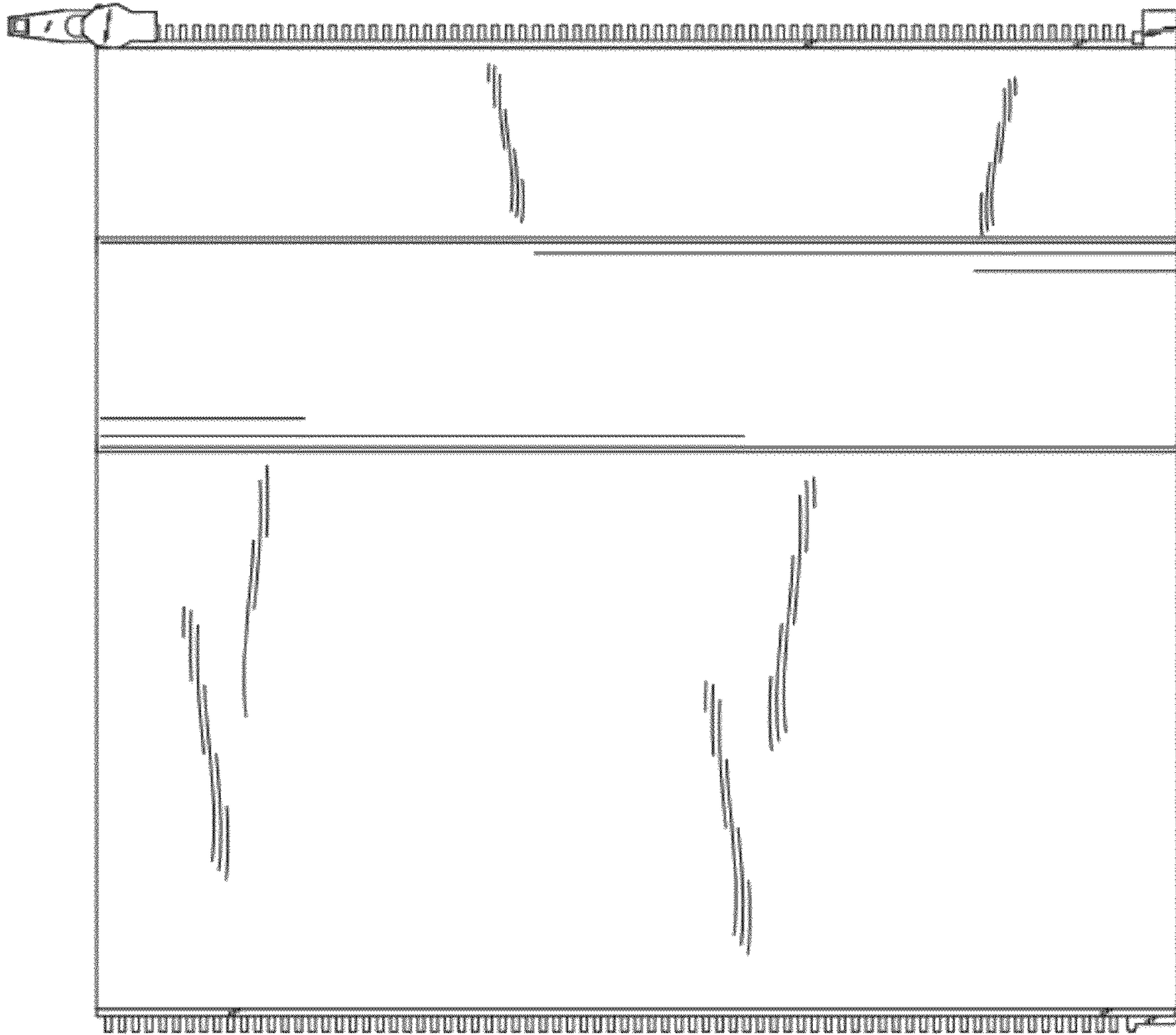

Fig. 3

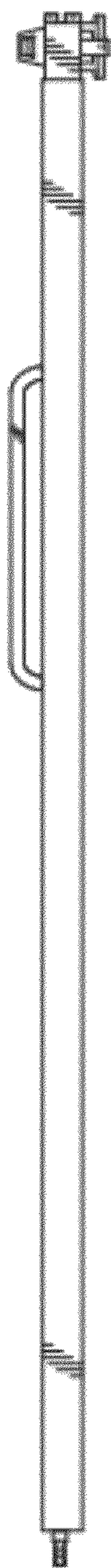

Fig. 4

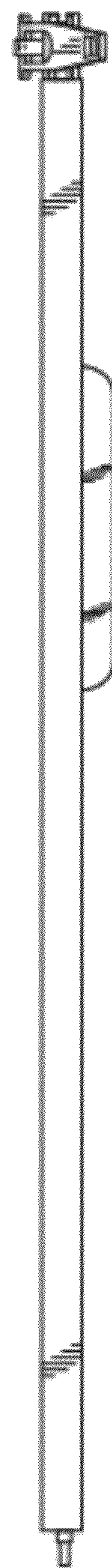

Fig. 5

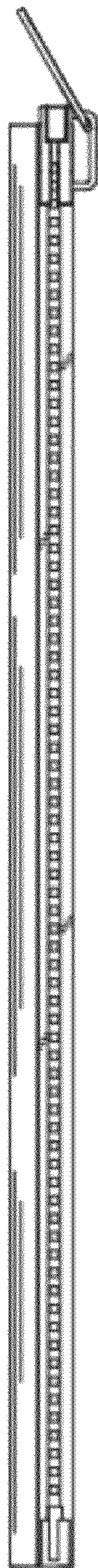

Fig. 6

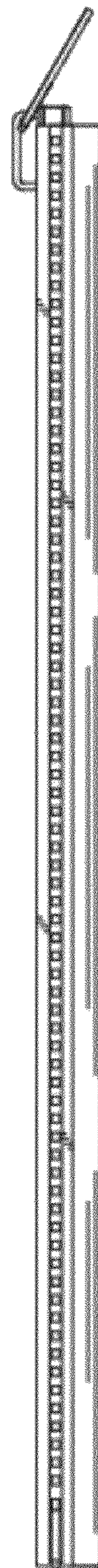

Fig. 7